

upstage

price & application guide

01.27.2025

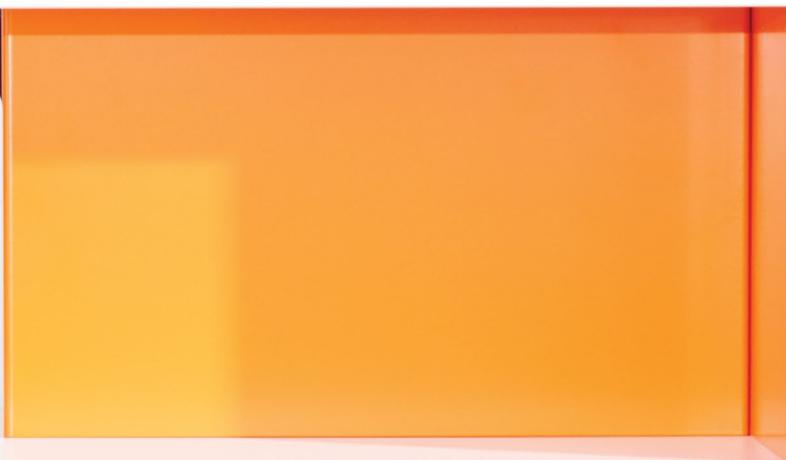

teknion



# update summary

Please be advised that information has been updated within the upStage Price & Application Guide. To highlight these updates, a summary has been created for your reference.

## revised

General maintenance to this guide has been implemented.

**Please note, first orders for new products will be accepted on January 27, 2025. All software will also be updated by January 27, 2025. If you have any questions regarding the information enclosed, please contact your Teknion Customer Service Representative.**





WHAT IS UPSTAGE . . . . . 7

INDEX . . . . . 17

APPLICATION GUIDE . . . . . 23

PRICE & PRODUCT GUIDE. . . . . 231



# inspiration

**upStage is a furniture based system consisting of workspaces, storage, screens and accessories that drop into place and fit together. It is supported by a stage that houses power/data.**



**real furniture** A truly unique structural solution, the staging unit integrates a full complement of desks, height-adjustable tables, cabinets, shelves, cubbies and screens and serves as a conduit for electrics. Every element simply moves into place and fits together, offering innumerable combinations and fresh design concepts for a dynamic and collaborative workplace.

**creative freedom** A rich material vocabulary gives designers an opportunity to be original and bold; to use color and texture to create a more varied and more inspiring work environment. upStage offers a myriad of options, including textiles and wood veneer, translucent and back-painted glass, perforated metal and a range of beautiful metal finishes.

**user choices** Offering an array of versatile furniture pieces, upStage gives users the ability to tailor the layout and configuration of their own workspace, the position and height of desks, cabinets, cubbies and screens. Equally, teams can create the workspace that works best for their project, moving tables and desks around and adjusting the level of privacy. As priorities change, upStage adapts.

# what is upstage

---

## components and features

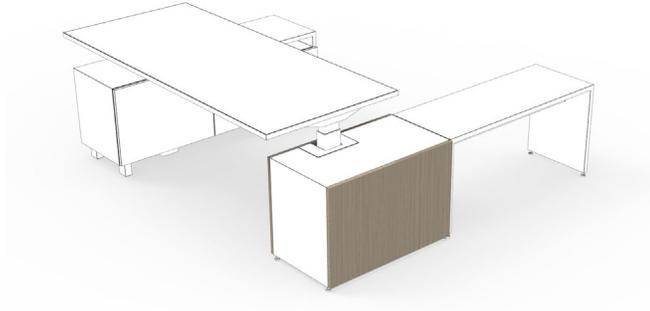

### stage

- The stage and simple Stage is the support structure for workstation configurations. Height-Adjustable Tables can be integrated into a Height-Adjustable Power Modules allowing the Leg of the table to be concealed, giving it a clean and integrated look. It can also be placed adjacent to the Stage
- The Stage incorporates Navigate Height Adjustable tables in a variety of configurations:
  - Both legs exposed
  - One leg concealed
  - Two legs concealed



### electrics

- Stage power can be accessed along the stage with Flexible Power Modules or on the worksurface with Access Doors or Rectangular Grommets
- Simple stage power is in fixed locations, it is accessed by a power box



# components and features



## upstage storage

- upStage storage options include Hutch Stackers, Credenzas, Bookcases, Hinged Door Stackers, Lateral Storage, Lockers and Cubby Lockers to provide a unique workstation landscape



## district storage

- upStage can also accommodate all 16" deep District Storage Stackers including the Systems Stacker Bookshelf (see *District Storage Application Guide*)

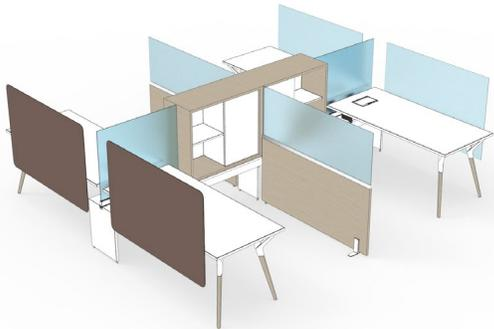

## screens

- A wide range of screens define space and offer varied degrees of visual privacy and functionality
- Functional Screens mount to the stage on and off-module and are available tackable, solid, metal, with accessory rail or whiteboard
- Glass add-on screens can be added to the Functional Screens to create height and a greater sense of enclosure
- Casual Screens are available as Desk Edge (Glass and Solid, Infinity & Framed), Stage Mounted or Lateral Screen in glass, tackable or solid

# what is upstage

## planning with upstage

upStage provides the functionality and flexibility of a panel system, but reinterprets how components are planned to give a real furniture look. The same criteria is met and provides new and exciting furniture layouts.

criteria: overhead & rethinking panels

panel system

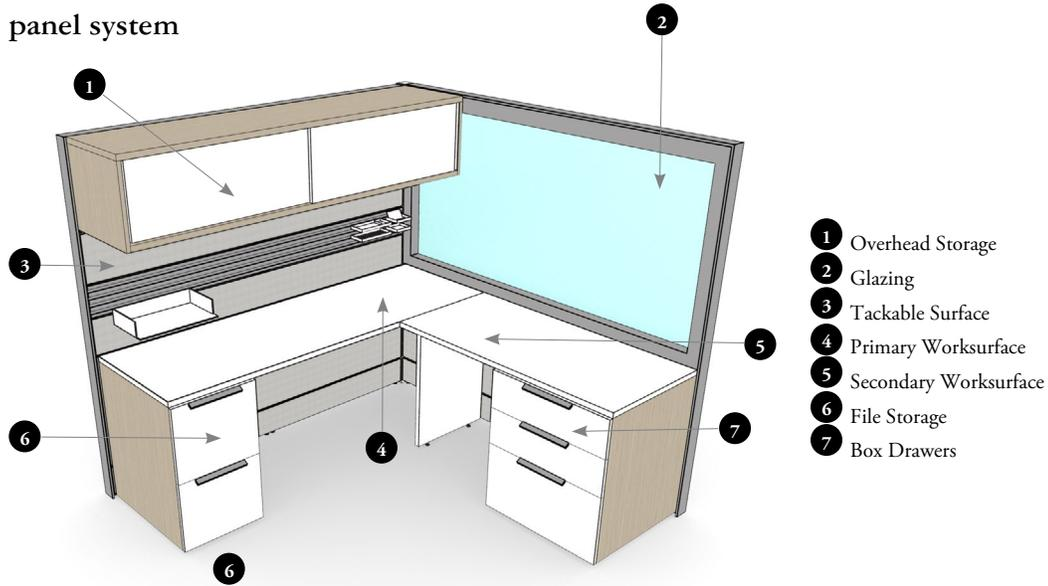

- 1 Overhead Storage
- 2 Glazing
- 3 Tackable Surface
- 4 Primary Worksurface
- 5 Secondary Worksurface
- 6 File Storage
- 7 Box Drawers

upstage

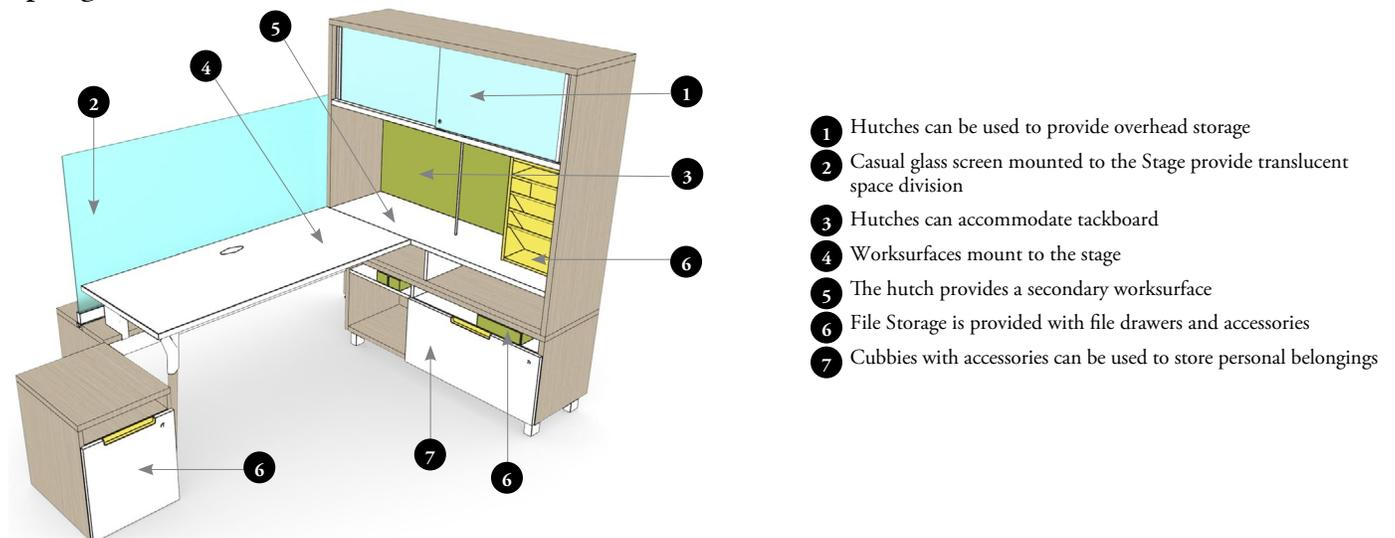

- 1 Hutches can be used to provide overhead storage
- 2 Casual glass screen mounted to the Stage provide translucent space division
- 3 Hutches can accommodate tackboard
- 4 Worksurfaces mount to the stage
- 5 The hutch provides a secondary worksurface
- 6 File Storage is provided with file drawers and accessories
- 7 Cubbies with accessories can be used to store personal belongings

# planning with upstage (continued)

criteria: rethinking storage

spine planning

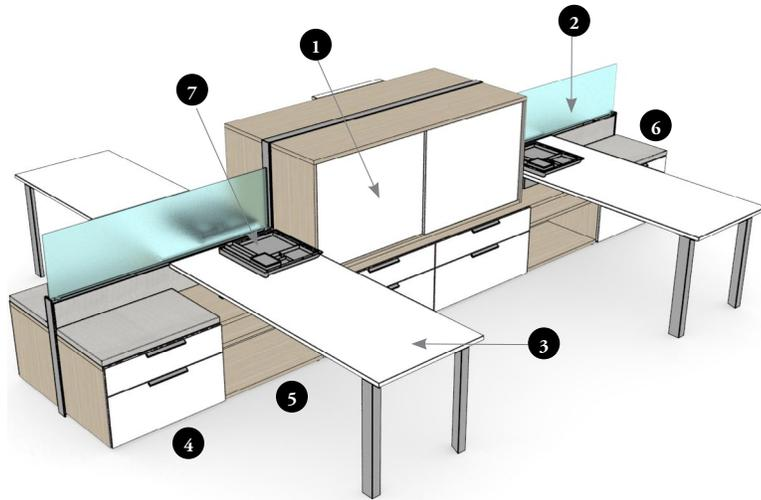

- 1 Stack-on Storage
- 2 Glazing
- 3 Primary worksurface
- 4 File Storage
- 5 Open Storage
- 6 Guest Seating
- 7 Accessories

upstage

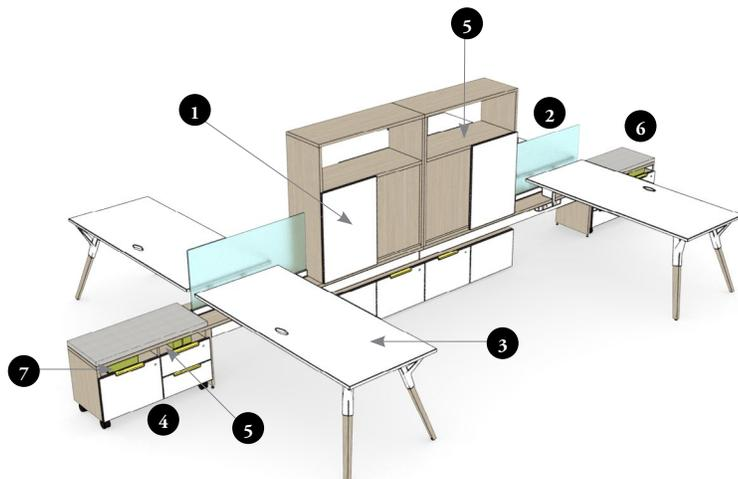

- 1 Back to back storage cabinets mount into the Stage
- 2 Casual glass screen mounted to the stage provide translucent space division
- 3 Worksurfaces mount to the stage
- 4 Elevated credenzas and stage credenzas provide shared or individual storage and can be placed beside or below the stage to create more open space in the workstation
- 5 Open cubbies in stackers and credenzas provide storage and provide a light and airy feel to a workstation
- 6 Cushion can be placed on elevated storage stages to provide guest seating
- 7 Accessories are designed to fit into cubbies to provide storage for small items

## planning with upstage (continued)

Criteria: Adding Light & Rethinking Storage

### storage spine

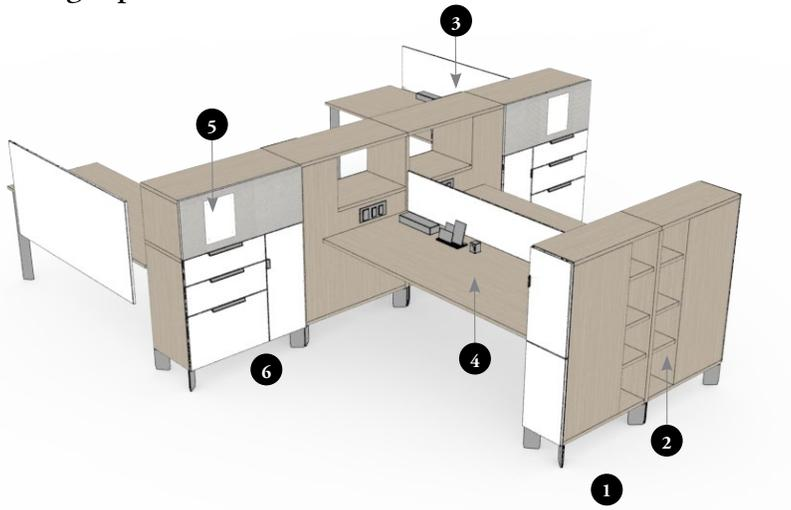

- 0 Storage Spine
- 1 Hinged door Storage
- 2 Open Storage
- 3 Casual Screens
- 4 Mounted Worksurface
- 5 Tackable Surface
- 6 File Storage

### upstage

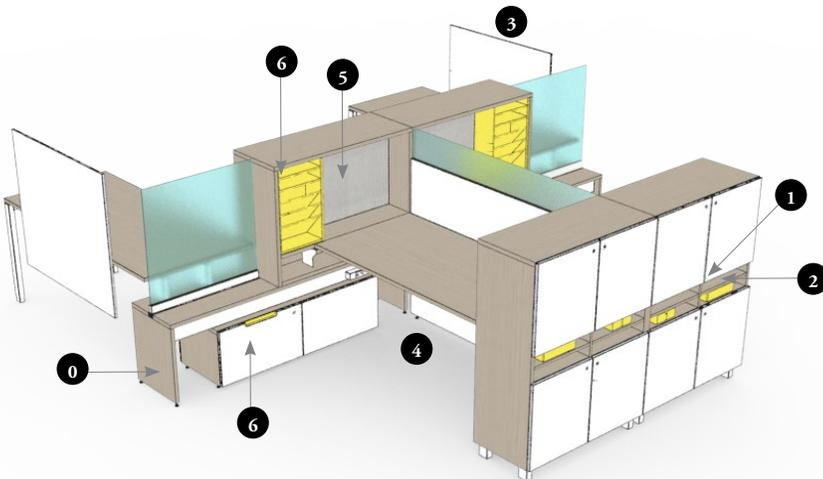

- 0 The stage provides support for storage worksurfaces and routes power through a workstation
- 1 Unique locker formats allow for hinged storage
- 2 Cubbies provide open storage for small items
- 3 Casual screens mount to worksurfaces to provide privacy
- 4 Worksurfaces mount to hutches to allow for "Zero footprint" planning
- 5 Hutches can accommodate tackboards or they can mount to the back of stacking storage or lockers
- 6 File storage is provided with file drawers and accessories

## upstage assets

Teknion offers a variety of assets to help better understand upStage and all that it can do.

Go to [www.teknion.com](http://www.teknion.com) to review all of the assets shown below.

what is upstage

---

## idea starters

The following layouts are available on the **Teknion Planning Tool**.

# idea starters

introduction



# index

Section Contents	Product Code	Page No.
<b>WHAT IS UPSTAGE</b>		
Inspiration		7
Components and Features		8
Planning with upStage		10
upStage Assets		13
Idea Starters		14
<b>APPLICATION GUIDES</b>		
Understanding Application Guide Pages		25
<b>STAGE</b>		
Understanding Stages		28
Standard Stage Basics		30
Planning with Standard Stages		31
Understanding Standard Stage Electrics		33
Standard Stage Power Entry Basics		34
Planning with Standard Stage Power Entry		35
Understanding Standard Stage Data/Communications		36
Standard Stage Power Distribution Basics		38
Planning with Standard Stage Power Distribution		39
Simple Stage Basics		40
Planning with Simple Stages		41
Understanding Simple Stage Electrics		44
Simple Stage Power Entry Basics		45
Planning with Simple Stage Power Entry		46
Understanding Simple Stage Data/Communications		48
Simple Stage Power Distribution Basics		49
Planning with Simple Stage Power Distribution		50
Power Conservation System Basics		51
Planning with Power Conservation System		52
<b>WORKSURFACES &amp; SUPPORTS</b>		
Understanding Worksurfaces		56
Worksurface Basics		58
Tables Basics		59
Planning with Worksurfaces		60
Worksurface Power Access Basics		65
Wire Management Basics		66
Planning with Worksurface Power Access		67
Wiring Systems		70
Worksurface Grain/Pattern Direction		71
Worksurface Supports & Accessory Basics		72
Planning with Worksurface Supports		73
<b>HEIGHT-ADJUSTABILITY</b>		
Understanding Height-Adjustable Tables		82
upStage Navigate Height-Adjustable Table Basics		84
upStage hiSpace Height-Adjustable Tables Basics		86
Planning with upStage Height-Adjustable Tables		88
Stage Module for Height-Adjustable Table Basics		93
Planning with Stage Module for Height-Adjustable Tables		94

Section Contents	Product Code	Page No.
Stage Module for Height-Adjustable Table Power Distribution Basics		97
Planning with Stage Module for Height-Adjustable Table Power Access		98
Credenza for Height-Adjustable Table Basics		100
Planning with Credenzas for Height-Adjustable Tables		101
<b>SCREENS</b>		
Understanding Screens		110
Casual Screen Basics		112
Planning with Casual Screens		113
Desk Edge Screen Basics		115
Planning with Desk Edge Screens		119
Desk Edge Floor Screen Basics		126
Planning with Desk Edge Floor Screens		127
Desk Edge Screens with Glass Basics		128
Planning with Desk Edge Screens with Glass		129
Modesty Screen Basics		130
Solid Lateral Screen Basics		131
Planning with Solid Lateral Screens		132
Solid Corridor Screen Basics		134
Planning with Solid Corridor Screens		135
Lateral Screen Basics		138
Functional Screen Basics		139
Planning with Functional Screens		141
<b>HUTCH STACKERS &amp; ACCESSORIES</b>		
Understanding Hutch Stackers		146
Hutch Stackers Basics		148
Planning with Hutch Stackers		149
Hutch Stackers with Sliding Door Basics		150
Planning with Hutch Stackers with Sliding Door Overhead		151
Planning with Hutch Stackers & Hutch Stackers with Overhead		152
Hutch Stackers Finishes		156
Hutch Stackers with Sliding Door Overhead Finishes		157
Hutch Accessory Basics		158
Hutch Fascia Add-Ons Basics		159
Planning with Fascia Add-Ons		160
Elevated Hutch Basics		162
Planning with Elevated Hutches		163
Elevated Hutch & Lateral Tower Finishes		164
<b>STORAGE</b>		
Understanding Credenzas		168
Stage Credenzas Basics		170
Planning with Stage Credenzas		171
Elevated Credenzas Basics		172
Planning with Elevated Credenzas		173
Pedestal Basics		174
Credenza Finishes		175
Bookcase Basics		177
Planning with Bookcases		178
Bookcase Finishes		181
Variable Bookcase Finishes		182

## index

Section Contents	Product Code	Page No.
Hinged Door Stacker Basics		183
Planning with Hinged Door Stackers		184
Hinged Door Stacker Finishes		185
Locker Basics		186
Planning with Lockers		187
Locker Finishes		188
Storage Support Basics		189
Lateral Tower Basics		190
Planning with Lateral Towers		191
Side Filer & Mini Side Filer Basics		194
Planning with Side Filers & Mini Side Filers		195
Planning with Side Filers		196
Planning with Mini Side Filers		197
Planning with Side Filer, Mini Side Filer & USB Power		198
Storage Cube Basics		200
Planning with Storage Cube		201
<b>STORAGE ACCESSORIES</b>		
Accessory Basics		204
Planning with Accessories		205
Storage Fascia Add-On Basics		208
Planning with Storage Fascia Add-On		209
Accessory Bundle Basics		210
Planning with Accessory Bundles		211
Hutch Stacker Lock Chart		212
Credenza Lock Chart		213
Hinged Door Stacker Lock Chart		212
Locker lock Chart		217
Grain Direction		218
Drawer & Opening Sizing Chart		221
Filing Capabilities		228
<b>STAGE</b>		
Beginning Stage	HTBB	236
Middle Stage	HTBM	238
Finish Stage	HTBF	240
Complete Stage	HTBC	242
Stage Center Support	HTBS	245
Beginning Simple Stage	HTDB	246
Middle Simple Stage	HTDM	248
Finish Simple Stage	HTDF	250
Complete Simple Stage	HTDC	252
Simple Stage Center Support	HTDS	254
Stage Accessory Beam Cover	HTBR	255
Stage Connector	HTBA	256
Stage Grommet	HTBG	257
<b>WORKSURFACES &amp; SUPPORTS</b>		
Parallel Worksurface	HTWR	262
Perpendicular Worksurface	HTWP	266
Perpendicular with Radius Corner Worksurface	HTWH	270
Dual Perpendicular Worksurface	HTWV	274

Section Contents	Product Code	Page No.
Dual Perpendicular with Radius Corner Worksurface	HTWW	276
End Worksurface	HTWG	278
End with Radius Corners Worksurface	HTWZ	279
Interpret Style Table	HTWT	279
Interpret Style Radius Corner Table	HTWU	282
Interpret Style Leg	HTWN	284
Interpret Style Mono Leg	HTWM	285
Y Table	HTWE	286
Y Table Radius Corner	HTWX	287
Y Leg	HTWD	288
Stage to Worksurface Support	HTWQ	289
Storage Back to Worksurface Support	HTWS	290
Credenza to Worksurface Support	HTWC	291
Stage to Dual Worksurface Support Kit	HTWB	292
End Worksurface Support Kit	HTWJ	294
Hutch to Worksurface Support	HTWF	295
Worksurface Support Wire Manager	HTWY	296
Flush Plate	HTWA	297
Worksurface Reinforcement Channel	UNRC	298
<b>HEIGHT-ADJUSTABILITY</b>		
Single Stage Module for Height-Adjustable Table	HTBH	304
Double Stage Module for Height-Adjustable Table	HTBD	305
Navigate Height-Adjustable Built-In Base	YGU <small>One Table One Plug</small>	306
Navigate Height-Adjustable Built-in Gable Base	YVU <small>One Table One Plug</small>	308
hiSpace Height-Adjustable Built-in Base with Quick Connect	YSU	310
Rectangular Height-Adjustable Worksurface, Gable	WBU	312
Rectangular Height-Adjustable Worksurface with Radius Corners	WJU	316
hiSpace Rectangular Height-Adjustable Worksurface	WBA	318
hiSpace Rectangular Height-Adjustable Worksurface with Radius Corner for Quick Connect	WJB	319
Double Credenza for Height-Adjustable Table	HTSCC	320
Triple Credenza for Height-Adjustable Table	HTSCT	322
Height-Adjustable Integrated Double Credenza	HTSCD	324
Height-Adjustable Integrated Triple Credenza	HTSCP	326
<b>CASUAL SCREENS</b>		
Casual Glass Screen	HTNX	334
Casual Solid Screen	HTND	335
Casual Thick Solid Screen	HTNJ	336
Casual Thick Solid Screen with Glass	HTNK	338
Casual Infinity Screen	GXAU	340
Casual Fabric Screen	HTNB	342
Glass Desk Edge Screen	HTNG	343
Solid Desk Edge Screen	HTNS	344
Infinity Curved Desk Edge Screen	GXCU	348
Infinity Desk Edge Screen	GXDU	352
Quilted Infinity Desk Edge Screen	GQDU	366
Infinity Side Desk Edge Screen	GXSU	368

Section Contents	Product Code	Page No.
Fabric Desk Edge Screen	HTNF	372
Framed Fabric Side Desk Edge Screen	GYSU	376
Infinity Desk Edge Floor Screen	GXFU	380
Infinity Side Desk Edge Floor Screen	GXEU	386
Infinity Screen Alignment Clip	GXCC	383
Framed Fabric Desk Edge Floor Screen	GYFU	384
Framed Fabric Side Desk Edge Floor Screen	GYEU	386
Desk Edge Screen with Glass	GVGU	388
Modesty Screen	HTNN	390
Solid Lateral Screen	HTNL	392
Solid Lateral Screen with Glass	HTNA	396
Solid Corridor Screen	HTNC	401
Solid Corridor Screen with Glass	HTNE	402
Glass 6mm Lateral Screen	GNGU	404
Glass 10mm Lateral Screen	GNTU	405
Writeable Glass Lateral Screen	GNWU	406
Solid Lateral Screen	GNSU	376
Writeable Laminate Lateral Screen	GNLU	408
Infinity Lateral Screen	GNXU	409
Smooth Felt Lateral Screen	GNZU	410
Framed Fabric Lateral Screen	GNYU	411
Metal Lateral Screen	GNMU	412
<b>FUNCTIONAL SCREENS</b>		
Functional Screen Frame	HTCF	416
Top Trim	HTCT	417
Top Trim for Glass Add-On	HTCG	418
End Trim	HTCE	419
Fabric Fascia	HTCR	420
Whiteboard Fascia	HTCW	422
Accessory Fascia	HTCA	423
Fascia Post Kit	HTCK	424
Glass Add-On Screen	HTCL	425
Screen Connector	HTCC	426
<b>HUTCH STACKERS &amp; ACCESSORIES</b>		
Open Through Hutch Stacker	HTSHN	432
Open Through Hutch Stacker with		
Sliding Door Overhead	HTSHNK	436
Solid Back Hutch Stacker	HTSHS	438
Solid Back Hutch Stacker with Sliding Door Overhead	HTSHSK	440
Glass Back Hutch Stacker	HTSHG	442
Glass Back Hutch Stacker with Sliding Door Overhead	HTSHGK	446
Perforated Hutch Stacker	HTSHP	450
Perforated Hutch Stacker with Sliding Door Overhead	HTSHPK	452
Elevated Hutch Stacker	HTSHE	454
Hutch Fascia Add-On	HTAH	456
Hutch Overhead Fascia Add-On	HTAV	462
Hutch Accessory	HTHA	464

Section Contents	Product Code	Page No.
<b>STORAGE</b>		
Bookcase Stacker	HTSB	472
Solid Door Bookcase Stacker	HTSBS	474
Fascia Door Bookcase Stacker	HTSBF	476
Writable Door Bookcase Stacker	HTSBW	480
Variable Bookcase Stacker	HTSBV	482
Single Solid Hinged Door Stacker	HTSSS	484
Single Writable Hinged Door Stacker	HTSSG	488
Shared Solid Hinged Door Stacker	HTSSD	490
Shared Writable Hinged Door Stacker	HTSSP	492
Stage Single Credenza	HTSCJ	493
Stage Double Credenza	HTSCW	494
Stage Shared Double Credenza	HTSCU	496
Stage Triple Credenza	HTSCZ	498
Stage Shared Triple Credenza	HTSCV	500
Elevated Double Credenza	HTSCY	502
Elevated Triple Credenza	HTSCX	506
Elevated Shared Double Credenza	HTSCR	508
Elevated Shared Triple Credenza	HTSCQ	510
Lockers	HTSL	512
Cubby Lockers	HTSLC	514
Mobile Pedestal	HTSM	516
Lateral Tower	HTST	518
Side Filer	HTSFT	520
Mini Side Filer	HTSFS	524
Storage Cube	HTAB	526
<b>STORAGE ACCESSORIES</b>		
Bookcase Fascia Add-On	HTAN	532
Hinged Door Stacker Fascia Add-On	HTAZ	536
Stage Spacer Block	HTAS	538
Variable Bookcase Bookend	HTAD	539
Cushion	HTAC	540
Horizontal Filing Insert	HTAF	541
Mobile Cubby Tray	HTAT	542
Mini Tray Organizer	HTAG	543
Accessory Bundle	HTAK	544
Side Filer Boot Tray	HTAR	545
<b>ELECTRICS</b>		
Base Feed	HTEBF	551
Split Base Feed	HTEBS	552
Chicago Base Feed	HTEBC	553
Base Feed Cover	HTEFB	554
Ceiling Feed	HTECF	555
Chicago Ceiling Feed	HTECC	556
Power Harness	HTEBH	557
Flexible Power Module	HTEFP	558
Chicago Power Module	HTEFC	560
Simple Stage Power Box	HTEFS	561

## index

Section Contents	Product Code	Page No.
Multi-Circuit Desk Power Module	HTEM	562
Chicago Power Box for Height-Adjustable Stage Module	HTEPMC	563
Chicago Desk Power Module	HTEMC	564
Power Module for Height-Adjustable Stage	HTEPM	565
Communication Box	HTECB	566
Power Pole	HTEL	567
Access Door for Multi-Circuit Desk	HTEA	568
Rectangle Grommet	HTEG	569
Multi-Circuit Desk Housing	HTEN	570
I-Connector	HTEJIC	571
Four-Way Splitter	HTEJDB	572
Wire Clips	HTEW	573
Worksurface Cable Tray	HTE T	574
Receptacle Outlet	HTERO	575
Simple Stage Power Cover	HTEK	576
Data Extender Plate	HTEEE	577
Simple Stage Data Cover	HTEZ	578
Chicago Junction Box	HTEX	579
International Stage Mount Kit	VES	580
Power Conservation System	HTEPC	581
CALA Power Module	VBCU	582
CALA Jumper Power Harness	VBPH	583
CALA Power In Feed	VBPU	584
CALA Power Station	VBWB	585



application guide

# application guide

UNDERSTANDING APPLICATION GUIDE PAGES . . . . .	25
STAGE . . . . .	27
WORKSURFACE & SUPPORTS . . . . .	55
HEIGHT-ADJUSTABILITY . . . . .	81
SCREENS . . . . .	109
HUTCH STACKERS & ACCESSORIES . . . . .	145
STORAGE . . . . .	167
STORAGE ACCESSORIES . . . . .	203





# understanding application guide pages

This application guide will include the following types of pages.

application guides

---

understanding stages

The Stage provides a spine for workstation configurations. It routes power and data and provides support for storage and worksurfaces.

**standard stage**  
Available with flexible electric to provide maximum flexibility in a workstation



## understanding pages

Used to describe the intent and common features of a group of products.

application guides

---

standard stage basics

Beginning, Middle and Finish Stages are combined to create workstation spines. Complete Stages are used for single stage applications when combining with the Stage Module for Height-Adjustable Tables.

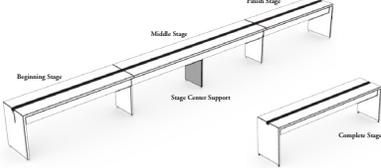

- Provides a base structure to support worksurfaces, storage and screens and to route power and data
- Width: 48" - 96" in 6" increments
- Height: 21"
- Depth: 16"
- Optional Accessory Braces available
- Single or Double Sided Power and Data is accessed through flip down doors
- Single Sided electric should only be used in applications where the stage is up against the wall. When Single Sided is placed in a corridor application, Stage hardware will be visible

**Stage Finish:**  
Screen Lamination, Fiberglass and Natural Veneer  
**Meal Finish:**  
Foundation, Mica and Accent colors

## basics pages

Used to describe the details of each individual product including:

- Product codes
- Dimensions
- Options
- Features
- Links to the price page

application guides

---

planning with standard stages

The following should be considered when planning with Stages.

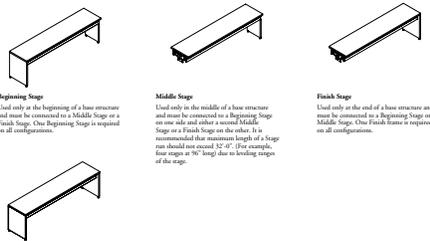

**Beginning Stage**  
Used only at the beginning of a base structure and must be connected to a Middle Stage or a Finish Stage. One Beginning Stage is required on all configurations.

**Middle Stage**  
Used only in the middle of a base structure and must be connected to a Beginning Stage on one side and either a second Middle Stage or a Finish Stage on the other. It is recommended that maximum length of a Stage run should not exceed 32'-0". For example, four stages at 8'0" long) due to leveling stages of the stage.

**Finish Stage**  
Used only at the end of a base structure and must be connected to a Beginning Stage or a Middle Stage. One Finish Stage is required on all configurations.

**Complete Stage**  
Complete Stages do not attach to Beginning, Middle or Finish Stages, they are intended to be used as single units only or attached to stage modules for height adjustable tables. If nonadjacent and non-Complete Stages need to be attached to each other, the Stage Connector (STTR) must be specified.

## planning pages

Used to outline the rules and restrictions that should be considered when planning with products.

stage

# stage

UNDERSTANDING STAGES . . . . .	28
STANDARD STAGE BASICS . . . . .	30
PLANNING WITH STANDARD STAGES . . . . .	31
UNDERSTANDING STANDARD STAGE ELECTRICS . . . . .	33
STANDARD STAGE POWER ENTRY BASICS . . . . .	34
PLANNING WITH STANDARD STAGE POWER ENTRY . . . . .	35
UNDERSTANDING STANDARD STAGE DATA/COMMUNICATIONS . . . . .	36
STANDARD STAGE POWER DISTRIBUTION BASICS . . . . .	38
PLANNING WITH STANDARD STAGE POWER DISTRIBUTION . . . . .	39
SIMPLE STAGE BASICS . . . . .	40
PLANNING WITH SIMPLE STAGES . . . . .	41
UNDERSTANDING SIMPLE STAGE ELECTRICS . . . . .	44
SIMPLE STAGE POWER ENTRY BASICS . . . . .	45
PLANNING WITH SIMPLE STAGE POWER ENTRY . . . . .	46
UNDERSTANDING SIMPLE STAGE DATA/COMMUNICATIONS . . . . .	48
SIMPLE STAGE POWER DISTRIBUTION BASICS . . . . .	49
PLANNING WITH SIMPLE STAGE POWER DISTRIBUTION . . . . .	50
POWER CONSERVATION SYSTEM BASICS . . . . .	51
PLANNING WITH POWER CONSERVATION SYSTEM . . . . .	52

## understanding stages

**The Stage provides a spine for workstation configurations. It routes power and data and provides support for storage and worksurfaces.**

### standard stage

Available with flexible electrics to provide maximum flexibility in a workstation

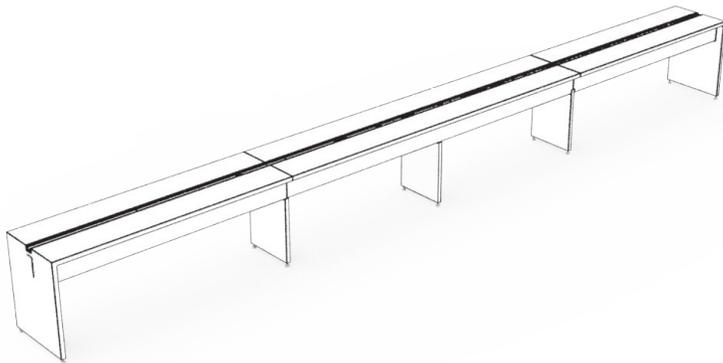

### simple stage

Provides a more economical solution for a stage when flexible electrics are not required

- Electrical is in fixed locations
- Can be linked to the standard stage



# understanding stages (continued)

## standard stage

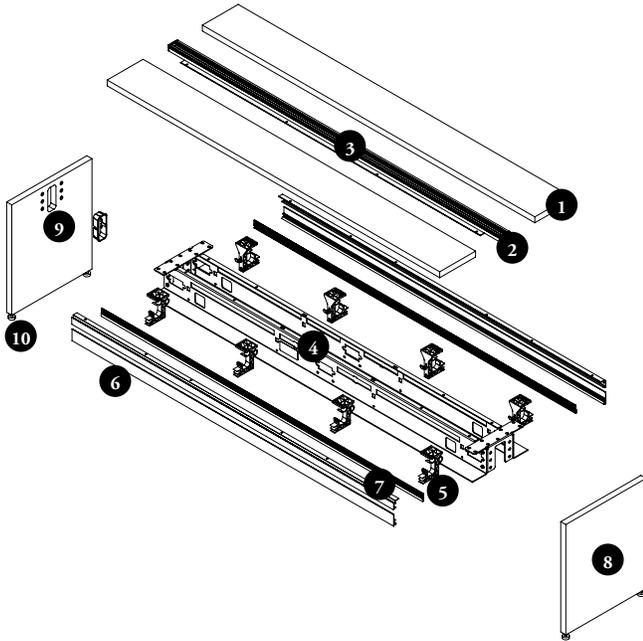

The standard stage consists of the following components:

- 1 Stage Surface for supporting worksurfaces, storage & hutches
- 2 Accessory Beam (optional) for mounting screens
- 3 Rail Cover (optional) for covering the exposed sections of the Accessory Beam
- 4 Data/Communication Cut Out to accept voice/Data Faceplates with a size of 2.71" x 1.38" (69mm x 35mm)
- 5 Cables management clips providing cable weight to both the exterior and interior of the stage Structure
- 6 Flip Down door for canaling power and data cord
- 7 Power Rail to support Flexible power Module
- 8 End Gable for supporting the ends of a stage
- 9 Infeed Grommet (optional) for routing harnesses
- 10 Levelers for leveling the stage (+2" -2")

## simple stage

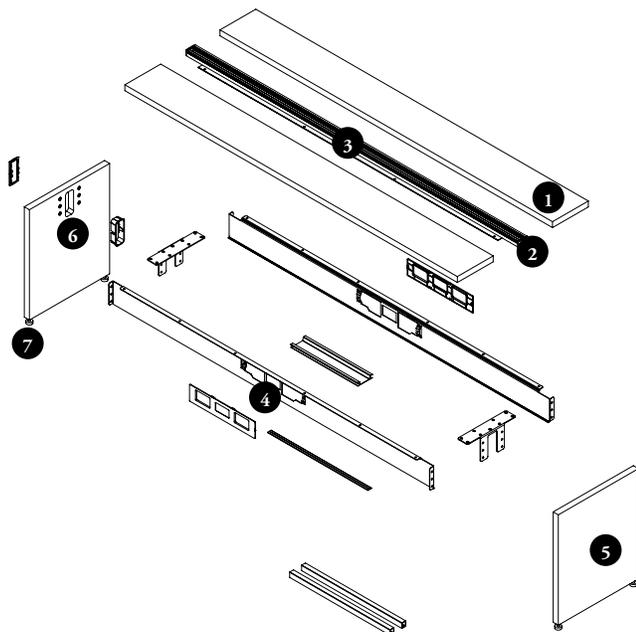

The simple stage consists of the following components:

- 1 Stage Surface for supporting worksurfaces, storage and hutches
- 2 Accessory Beam (optional) for mounting screens
- 3 Rail Cover (optional) for covering the exposed sections of the Accessory Beam
- 4 Data/Communication Cut-Out to accept voice/Data Faceplates with a size of 2.71" x 1.38" (69mm x 35mm)
- 5 End Gable for supporting the ends of a stage
- 6 Infeed Grommet (optional) for routing harnesses
- 7 Levelers (+2" -2")

## standard stage basics

Beginning, Middle and Finish Stages are combined to create workstation spines. Complete Stages are used for single stage applications when combining with the Stage Module for Height-Adjustable Tables.

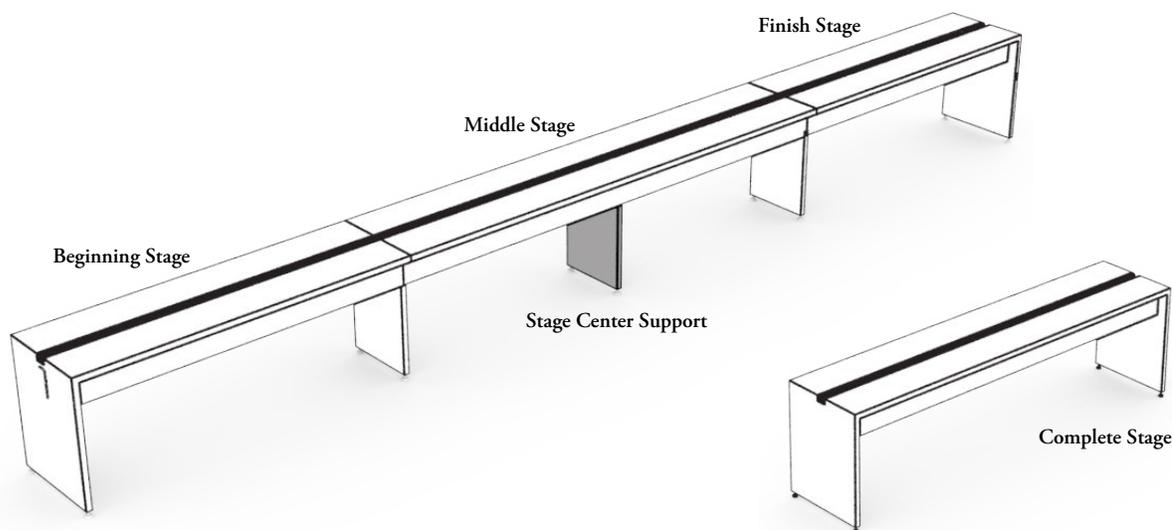

- Provides a base structure to support worksurfaces, storage and screens and to route power and data
- Widths: 48" - 96" in 6" increments
- Height: 21"
- Depth: 16"
- Optional Accessory Beam available
- Single or Double Sided Power and Data is accessed through flip down doors
- Single Sided electrics should only be used in applications where the stage is up against the wall. When Single Sided is placed in a corridor application, Stage hardware will be visible

**Stage Finishes:**  
Source Laminate, Flintwood and Natural Veneer  
**Metal Finishes:**  
Foundation, Mica and Accent colors

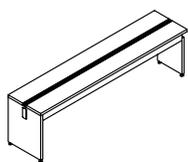

### Beginning Stage (HTBB)

- Includes one End Gable and one Mid Gable
- Infeed Grommet available for exterior base feed or power pole entrance



### Middle Stage (HTBM)

- Includes one Mid Gable

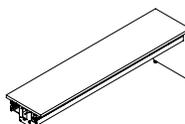

### Finish Stage (HTBF)

- Includes one End Gable
- Infeed Grommet available for exterior base feed or power pole entrance

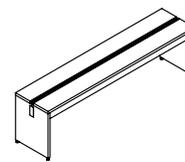

### Complete Stage (HTBC)

- Includes two End Gables
- Infeed Grommet available on one or both sides for exterior base feed or power pole entrance



### Stage Center Support (HTBS)

- Used for additional support on Stages wider than 72"
- Must be mounted in the center location



### Stage Accessory Beam Cover (HTBR)

- Used to conceal the exposed portion of the optional Accessory Beam when screens are not being used
- Available in widths of 48" - 96" in 6" increments
- Can be cut on site



### Stage Connector (HTBA)

- Used to connect two Complete Stage End Gables together if Stages are reconfigured



### Stage Grommet (HTBG)

- Stages are available with an option for a Grommet and Cover at time of order. The Grommet Cover is only ordered when an additional infeed is required on site
- Specified on Beginning, End and Complete Stages

# planning with standard stages

The following should be considered when planning with Stages.

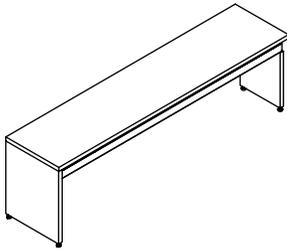

### Beginning Stage

Used only at the beginning of a base structure and must be connected to a Middle Stage or a Finish Stage. One Beginning Stage is required on all configurations.

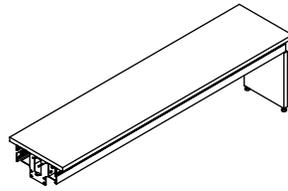

### Middle Stage

Used only in the middle of a base structure and must be connected to a Beginning Stage on one side and either a second Middle Stage or a Finish Stage on the other. It is recommended that maximum length of a Stage run should not exceed 32'-0". (For example, four stages at 96" long) due to leveling ranges of the stage.

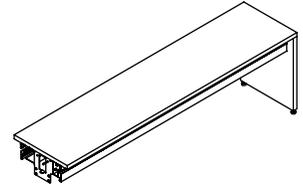

### Finish Stage

Used only at the end of a base structure and must be connected to a Beginning Stage or a Middle Stage. One Finish frame is required on all configurations.

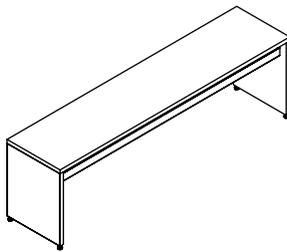

### Complete Stage

Complete Stages do **not** attach to Beginning, Middle or Finish Stages, they are intended to be used as single units only or attached to stage module for height-adjustable tables. If reconfigured and two Complete Stages need to be attached to each other, the Stage Connector (HTBA) must be specified.

## stage support

Stages greater than 72" wide require additional support. Support is provided by either the Stage Center Support (HTBS) or any Stage Credenzas .

On 72" wide Stages that support large amounts of storage and there is no Stage Credenzas underneath, it is recommended that the Stage Center Support (HTBS) be specified for additional support.

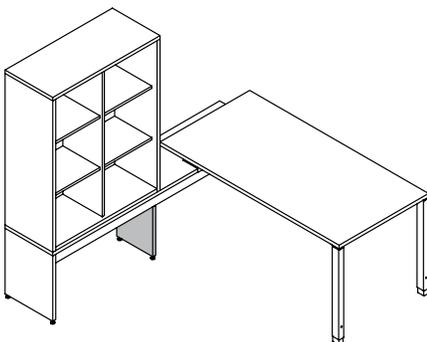

The Stage Center Support is installed in the middle of the stage to provide necessary support.

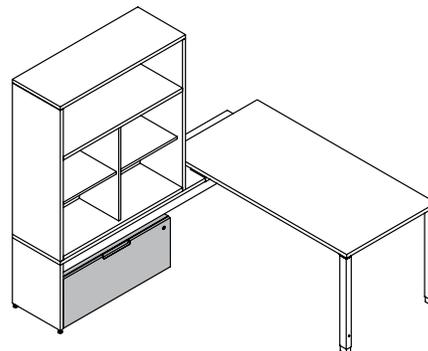

A Stage Credenza meets the underside of the stage to provide support. It can be located anywhere along the stage (See *Storage* section for Credenza info).

## planning with standard stages (continued)

### accessory beam

An optional 1-3/4" wide Accessory Beam can be specified on the stage for mounting Screens.

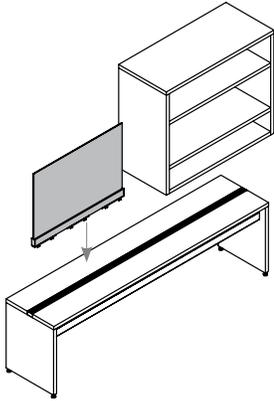

Screens must mount onto an Accessory Beam. Storage can be used on a Stage with an Accessory Beam, the beam will not obstruct the storage.

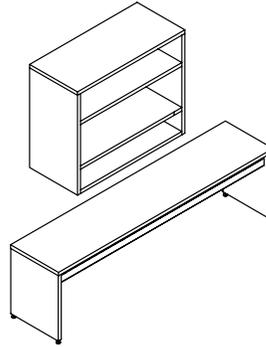

When specifying Stack on Storage only, no Accessory Beam is required.

### stage connector

The Stage Connector (HTBA) is used when existing Complete Stages are being attached together. All other Stages come with the required attachment brackets.

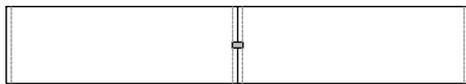

### grain direction

The grain direction will always run the length of a stage.

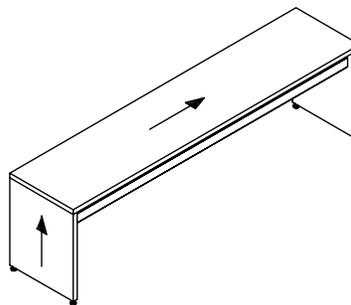

### leveling

To ensure a level Stage, the maximum number of suggested spine structures should not exceed four. Maximum leveling capabilities for each Stage are +2" and -1".

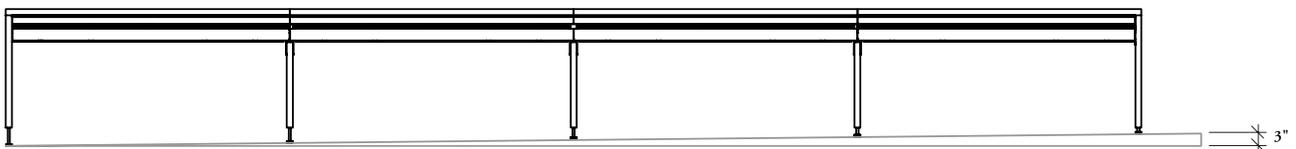



# understanding standard stage electrics

upStage power is distributed through the Stage using a Power Harness and Four-Way Splitters and is accessed with a Flexible Power Module that allows power to be positioned exactly where it is required.

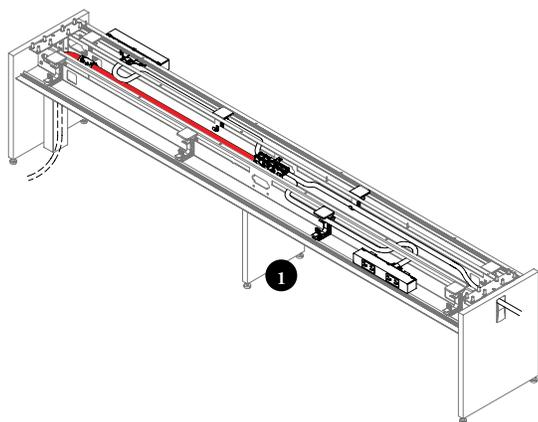

**1** Base Feed power enters the stage through a Base Feed cover at the End Gable and connects to a Four-Way Splitter. Power can also enter the stage through a Ceiling Feed and Power Pole.

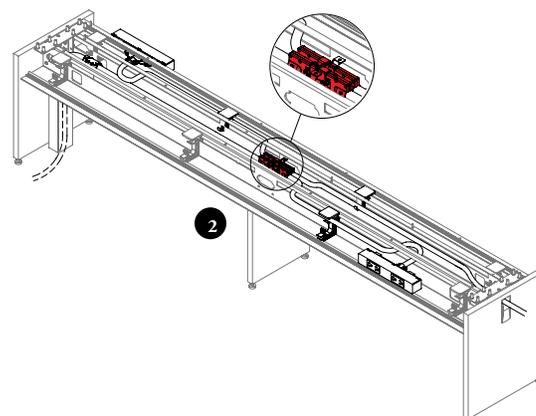

**2** Four-Way Splitters mount in the center of every Stage to accept Power Harnesses and Flexible Power Modules. It can route power in four directions.

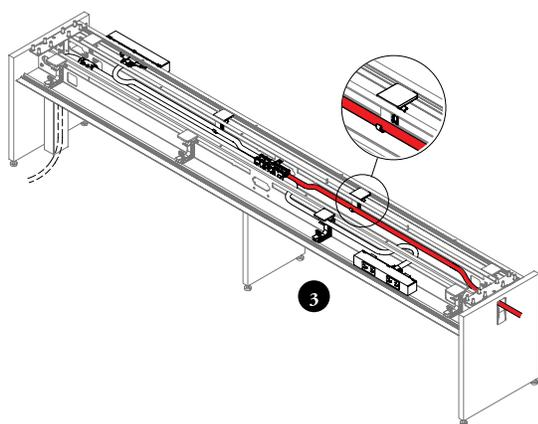

**3** Power Harnesses route power from a Four-Way Splitter to connecting Stages. Interior clips allow for wire management. These clips are designed to support Data/Connecting Cords. The Power Harnesses gets routed through interior clips.

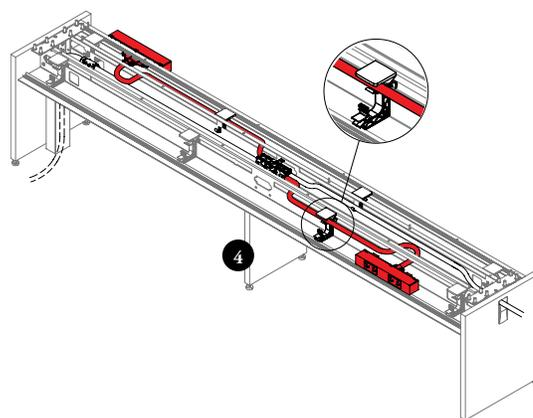

**4** Flexible Power Module mounts to the stage for easy access to power and can be moved anywhere along the length of the spine. The Cable routes to a Four-Way Splitter.

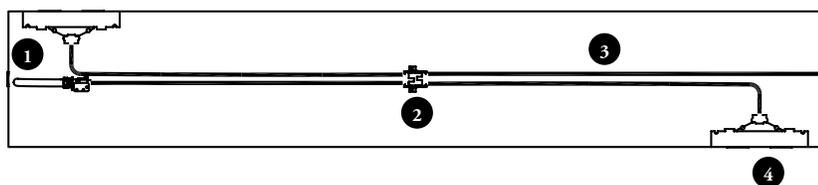

## standard stage power entry basics

Power can enter a Stage through either a Base Feed or a Ceiling Feed.



### Ceiling Feed (HTECF)

- Routes power from the ceiling to the workstation
- Wire systems:
  - 8-Wire Isolated Ground (8T)
  - 7-Wire Non Isolated Ground (7T)
  - 8-Wire Dual Isolated (8K)
  - 7-Wire Dual Non Isolated (7K)
- Used with the Power Pole (HTEL)
- Available 120" and 144" long



### Chicago Ceiling Feed (HTECC)

- Required for the city of Chicago electrical code requirements
- Used with the Power Pole (HTEL)
- Available 120" and 144" long



### Power Pole (HTEL)

- Routes a Ceiling Feed and Data Cables from the ceiling to the workstation
- Available in 96", 120" and 144" high
- Finishes available are Foundation, Mica and Accent colors



### Base Feed (HTEBF)

- Routes power from the floor into the stage, then on a Four-Way Splitter
- Wire systems:
  - 8-Wire Isolated Ground (8T)
  - 7-Wire Non Isolated Ground (7T)
  - 8-Wire Dual Isolated (8K)
  - 7-Wire Dual Non Isolated (7K)
- Available (For Stage modules less than 60" or 66" or more)
- When For Stage Module 66" or more option is selected, base feed will come with additional I-Connector and Short Harness to reach the required length



### Split Base Feed (HTEBS)

- Routes power from the floor into the stage, then to a Four-Way Splitter and is wired into the building power source in two locations for New York City wiring restrictions
- Wire systems:
  - 8-Wire Isolated Ground (8T)
  - 7-Wire Non Isolated Ground (7T)
  - 8-Wire Dual Isolated (8K)
  - 7-Wire Dual Non Isolated (7K)
- Available 72" long



### Chicago Base Feed (HTEBC)

- Required for the city of Chicago electrical code requirements
- Available 72" long

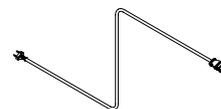

### upStage CALA Power In feed (VBPU)

- Routes power from the floor into the stage in CALA applications
- Length: 1800mm
- Country of Installation:
  - Argentina
  - Brazil
  - Chile



### Base Feed Cover (HTEFB)

- Used to route Base Feed and Data Cables into a workstation from the floor
- Applications available are Interior, Mid or Exterior of Stage
- Finishes available are Foundation, Mica and Accent colors

# planning with standard stage power entry

The following should be considered when planning with upStage power entry.

## power poles

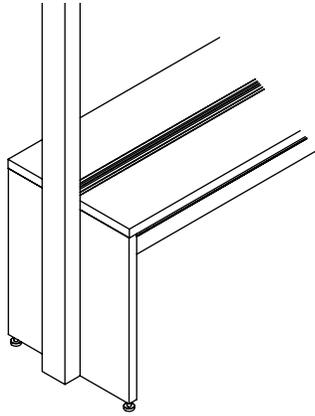

Power Poles mount to the outside of the Stage End Gable only in order to route power and data from the ceiling.

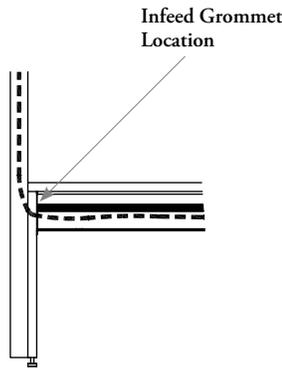

When using a Power Pole, the stage with an Infeed Grommet must be specified to allow power to enter the stage.

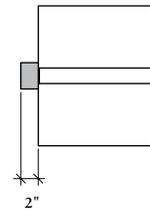

The Power Pole protrudes 2" beyond the stage gable.

## base feed cover

Mounts to either the outside of an End Gable or the inside of a Mid or End Gable.

Interior and Mid application

Outside application

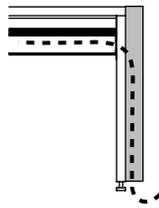
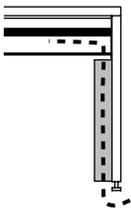

If mounting to the outside of the stage the Infeed Grommet must be specified.

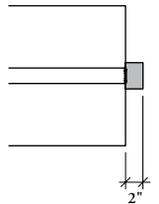
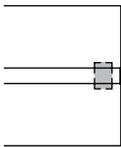

The Base Feed cover will protrude 2" beyond the base.

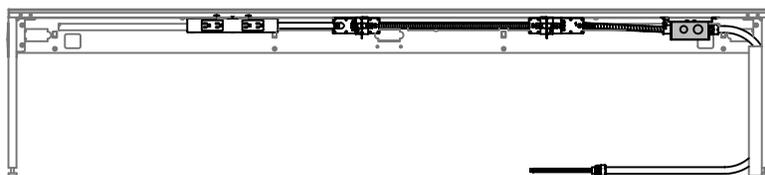
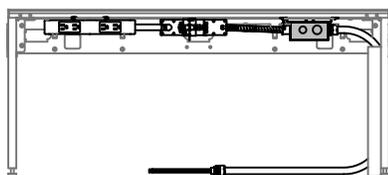

The Base Feed is available in two sizes:

- For stages 60" or less and 66" or more
- The width of the stage determines which option is required
- When used with a Stage that is 60" wide or less, the Harness connects directly to the first Four-Way Splitter
- When used with a Stage that is 66" wide or wider, the Harness is complete with an I-Connector and extension Harness which allows it to reach the first Four-Way Splitter

## understanding standard stage data/communications

The Stage provides various locations for both the Power Harness cable and data cables to be routed within the interior of the Stage.

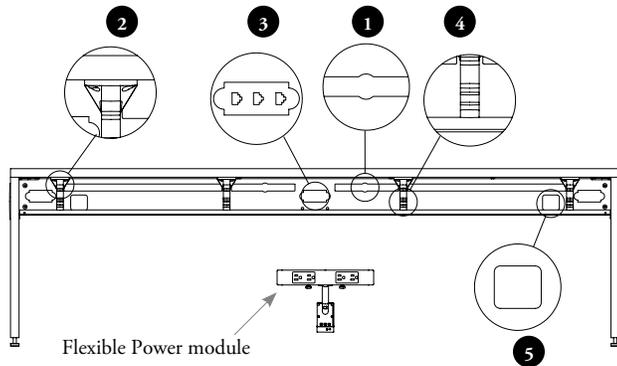

- 1 Flexible Power Module entry location into the interior of the stage structure
- 2 Upper clips are used to house Harness cables for Flexible Power Module
- 3 Opening for Data Plate
- 4 Lower clips are used to house Data cables
- 5 Data cable entry location from the exterior of the stage

The stages provide various locations that both the Power Harness cables can be routed from the Flexible Power Module through to the Four-Way Splitter within the interior of the stage. Data cables can enter and exit the stage interior on both ends and the center of the stage. Clips for both are provided along the stage exterior to allow Data and Power Harness cables to be routed separately through to the interior of the stage.

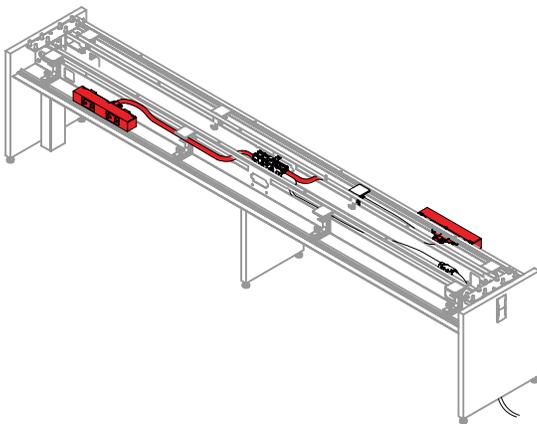

Power Harness cables are routed through designated Cut Out locations to maximize user adjustment.

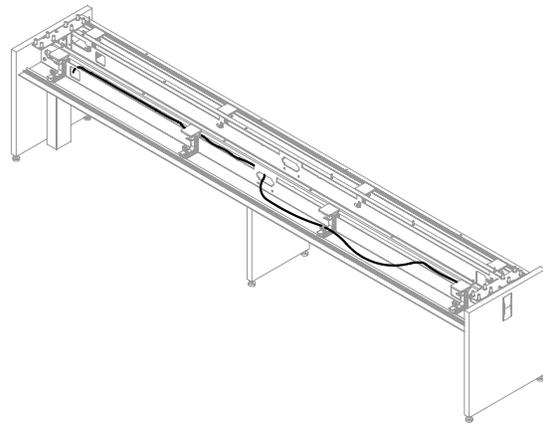

Data Cables are routed from the Exterior of the Stage down to the Data Plate through designated clips.

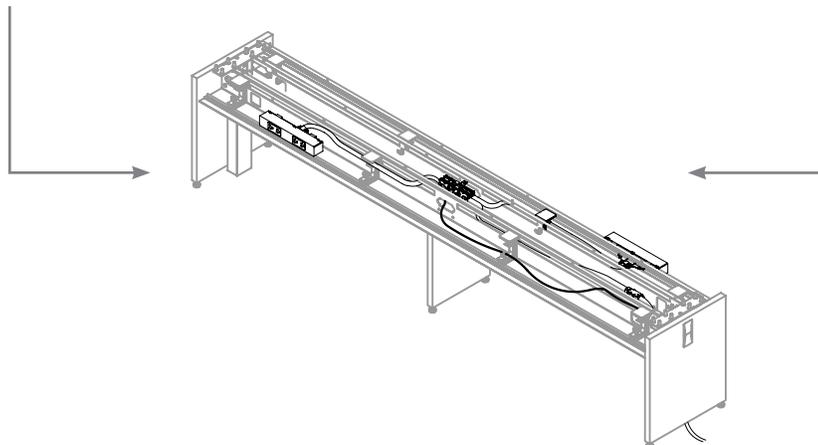

# understanding standard stage data/communications (continued)

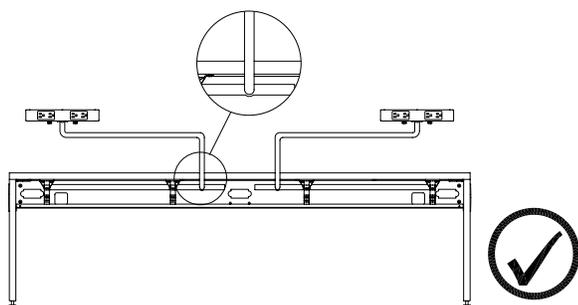

Above is the recommended installation of the attached Power Harness cable from the Flexible Power Module through the designated Cut Out locations in the stage structure to allow for maximum user adjustment. If the Power Harness cable is routed through the open channel not in the designed location of in the stage structure then the placement range of the Flexible Power Module will be limited to individual metal Cut Out locations instead of the complete Stage.

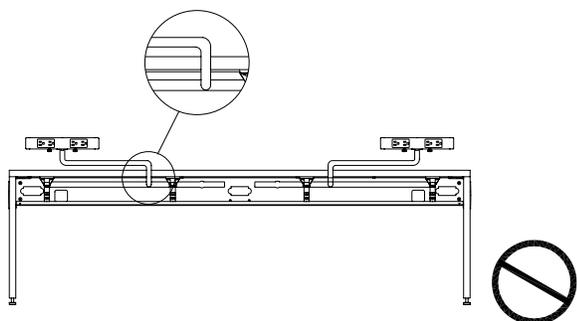

If the Power Harness cable is routed through the open channel not in the designed location of in the stage structure then the placement range of the Flexible Power Module will be limited to individual metal Cut Out locations instead of the complete Stage.

## standard stage power distribution basics

Power is distributed through the Stage with Power Harnesses and accessed with Flexible Power Modules.



Flexible Power Module



### Power Harness (HTEBH)

- Routes power through the stage by connecting to a Four-Way Splitter or I-Connector
- Wire system available:
  - 8-Wire Isolated Ground (8T)
  - 8-Wire Dual Isolated (8K)
- Lengths: 24" - 144" in 12" increments



### Chicago Power Module (HTEFC)

- Mounts anywhere along the stage to provide power for Chicago applications
- Cable length is 24", 36" and 48" and specified half the width of the stage for maximizing flexibility
- Standard 15 Amp and T-Slot 20 Amp available
- Includes one Power Module and two Data openings
- Data covers will always be Platinum (receptacles will have to be specified separately)
- Finishes: Gris and Very White



### I-Connector (HTEJIC)

- Used to join two harnesses when a single harness is not long enough



### Four-Way Splitter (HTEJDB)

- Mounts to the stage and connects to a power harness, ceiling feed and splits power in four directions
- Are typically mounted to the center of each Stage



### Flexible Power Module (HTEFP)

- Mounts any along the stage to provide Power
- Cable Lengths:
  - 24", 36" and 48"
  - Specified half the width of the stage for maximum flexibility
- Outlet Configurations
  - Circuit 1
  - Circuit 1 and 2
  - Circuit 1 and 3 (use 8T only)
  - Circuit 1 and 5
  - Circuit 1 and 6 (use 8K only)
  - Circuit 2 and 2
  - Circuit 2 and 3 (use 8T only)
  - Circuit 2 and 5
  - Circuit 2 and 6 (use with 8K only)
  - Circuit 3 and 3 (use 8T only)
  - Circuit 3 and 5 (use 8T only)
  - Circuit 5 and 5
  - Circuit 5 and 6 (use 8K only)
  - Circuit 6 and 6 (use 8K only)
  - USB and Circuit 1
  - Circuit 2 and 5 (use 7T and 7K only)
  - Circuit 1 and 6 (use with 7K only)
  - Circuit 2 and 2 (use 7T and 7K only)
  - Circuit 2 and 3 (use with 7K only)
  - Circuit 2 and 5 (use with 7K only)
  - Circuit 2 and 6 (use 7T and 7K only)
  - Circuit 3 and 3 (use with 7K only)
  - Circuit 3 and 5 (use with 7K only)
- Wiring Systems:
  - 8-Wire Isolated (8T)
  - 8-Wire Dual Isolated (8K)
  - 7-Wire Non-Isolated (7T)
  - 7-Wire Non-Dual Isolated (7K)

- Finishes:
  - Soft Gris
  - Very White
- Receptacles will automatically match the finish option selected



### Chicago Junction Box (HTEX)

- Used in place of the Four-Way Splitter in Chicago applications



### upStage CALA Power Module (VBCU)

- Mounts anywhere along the stage to provide power for CALA applications
- **Application:**
  - Single Sided, Single and Double Duplexes
- **Outlet Configurations:**
  - One Single Duplex
  - Two Power
  - One Power and One USB
  - Two Double Duplex
  - Four Power
  - Three Power and One USB
- **Country of Installation:**
  - Argentina
  - Brazil
  - Chile
- **Finishes:**
  - Ebony Coordinate
  - Very White Coordinate



### CALA Jumper Power Harness (VBPH)

- Routes power through the stage in CALA applications
- Connects to a Four-Way Splitter or I-Connector
- Length: 2000 mm
- Finish: Black

# planning with standard stage power distribution

The following should be considered when planning with Stage Power Distribution.

When power needs to pass through a Stage with no Flexible Power Modules, an I-Connector can be used between the two Harnesses, as only two connection points are required.

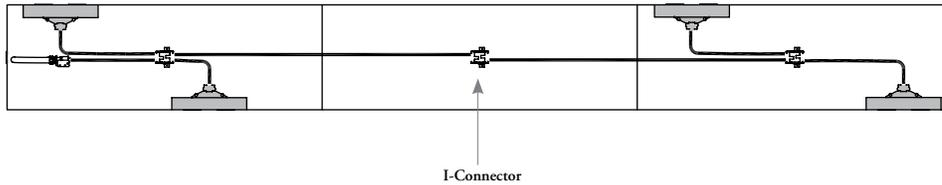

When more than one Flexible Power Module is required on the side of a Stage, an additional Four-Way Splitter can be used. The Harness length will be the distance between the two Four-Way Splitters.

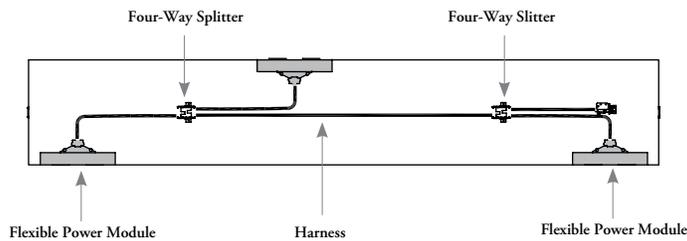

When two Stages of different widths are specified, the Four-Way Splitters center to center dimension is used to determine the harness length required.  
 Example: 72" Stage and a 48" Stage requires a 60" harness

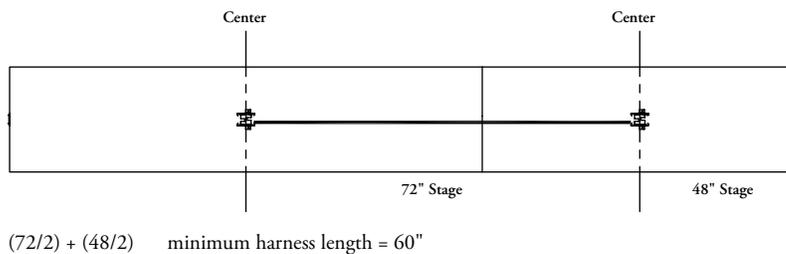

## power harness lengths

The following chart demonstrates the nominal vs. actually lengths of Power Harnesses:

Nominal	Actual
24"	24"
36"	48"
48"	48"
60"	72"
72"	72"
84"	96"
96"	96"
108"	120"
120"	120"
144"	144"

## simple stage basics

Beginning Simple Stage, Middle Simple Stage and Finish Simple Stages are combined to create workstation spines. Complete Simple Stages are used for single stage applications.

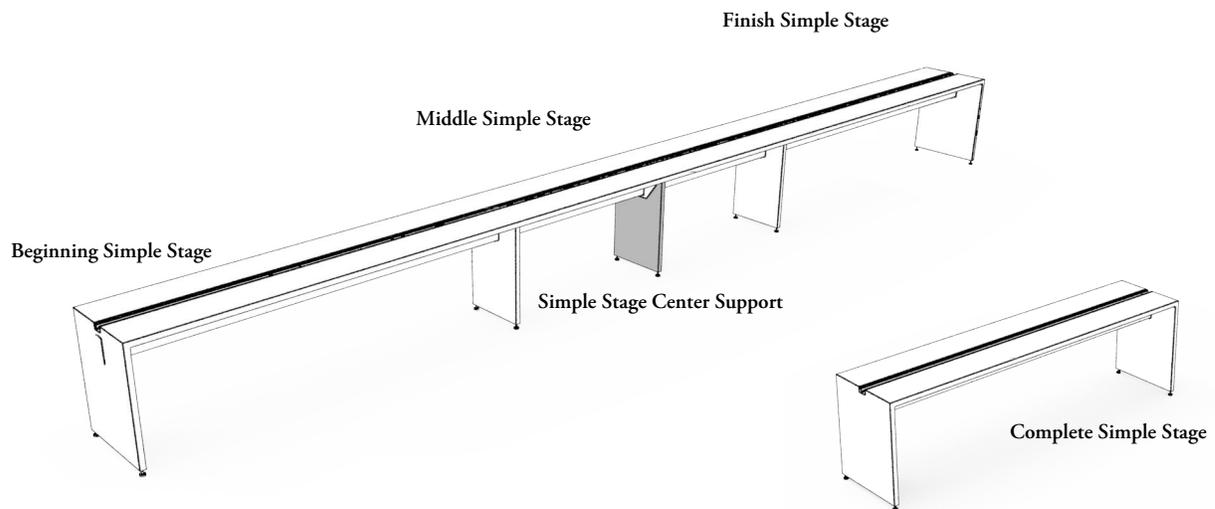

- Provides a simpler base structure to support worksurfaces, storage and screens and to route power and data
- Widths: 30" - 96" in 6" increments
- Available 21" high and 16" deep
- Optional Accessory Beam available
- Electrics are available as fixed or double sided on Simple Stages 72" - 96" wide

**Stage Finishes:**  
Source Laminate, Flintwood and Natural Veneer  
**Metal Finishes:**  
Foundation, Mica and Accent colors

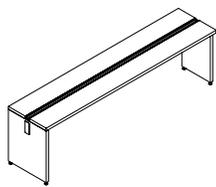

### Beginning Simple Stage (HTDB)

- Includes one End Gable and one Mid Gable
- Infeed Grommet available for exterior base feed or power pole entrance

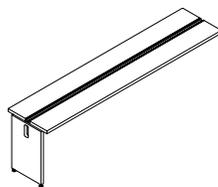

### Middle Simple Stage (HTDM)

- Includes one Mid Gable

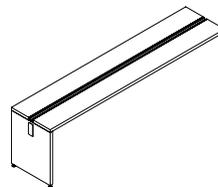

### Finish Simple Stage (HTDF)

- Includes one End Gable
- Infeed Grommet available for exterior base feed or power pole entrance

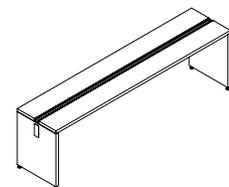

### Complete Simple Stage (HTDC)

- Includes two End Gables
- Infeed Grommet available on one or both sides for exterior base feed or power pole entrance



### Simple Stage - Center Support (HTDS)

- Used for additional support on Stages wider than 72"
- Must be mounted in the center location



### Stage Accessory Beam Cover (HTBR)

- Used to conceal the exposed portion of the optional Accessory Beam when screens are not being used
- Available in widths of 48" - 96" in 6" increments
- Can be cut on site



### Stage Connector (HTBA)

- Used to connect two Complete Stage End Gables together if Stages are reconfigured



### Stage Grommet (HTBG)

- Stages are available with an option for a Grommet and Cover at time of order. The Grommet Cover is only ordered when an additional infeed is required on site
- Specified on Beginning, End and Complete Stages



# planning with simple stages

The following should be considered when planning with Simple Stages.

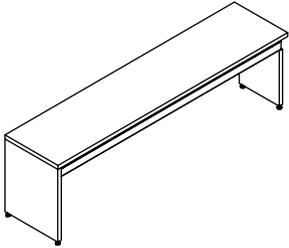

### Beginning Simple Stage

Used only at the beginning of a base structure and must be connected to a Middle Simple Stage or a Finish Simple Stage. Beginning Simple Stage or Beginning Standard Stage is required on all configurations.

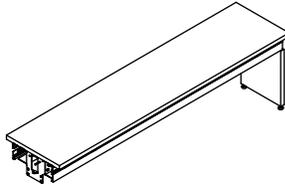

### Middle Simple Stage

Used only in the middle of a base structure and must be connected to a Beginning Simple Stage on one side and either a second Middle Simple Stage or a Finish Simple Stage on the other. It is recommended that maximum length of a Simple Stage run should not exceed 32'-0" (For example, four stages at 96" long) due to leveling ranges of the stage.

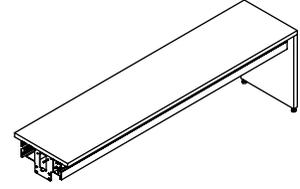

### Finish Simple Stage

Used only at the end of a base structure and must be connected to a Beginning Simple Stage or a Middle Simple Stage. One Finish frame is required on all configurations.

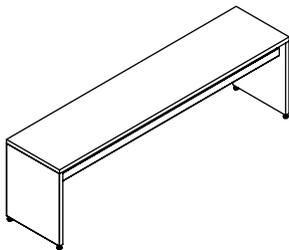

### Complete Simple Stage

Complete Simple Stages do not attach to Beginning, Middle or Finish Stages. They are intended to be used as single units only or attached to simple stage modules for height-adjustable tables. If reconfigured and two Complete Simple Stages need to be attached to each other, the Stage Connector (HTBA) must be specified.

## simple stage support

Stages greater than 72" wide or wider require additional support. Support is provided by the Simple Stage Center Support (HTDS).

On 72" wide Stages that support large amounts of storage and there is no Stage Credenzas underneath, it is recommended that the Stage Center Support (HTDS) be specified for additional support.

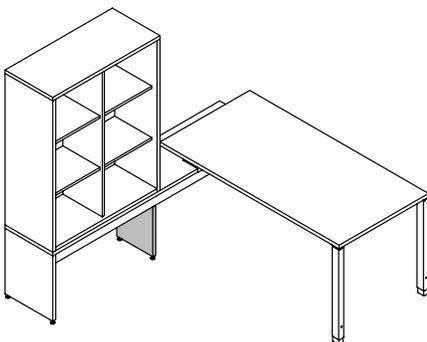

The Simple Stage Center Support is installed in the middle of the stage to provide necessary support.

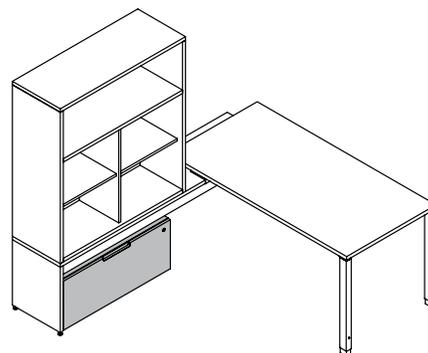

Stage Credenzas cannot be substituted for a center support, unless a Simple Stage Center Support (HTDS) is also specified.

## planning with simple stages (continued)

### accessory beam

An optional 1-3/4" wide Accessory Beam can be specified on the Simple Stage for mounting Screens.

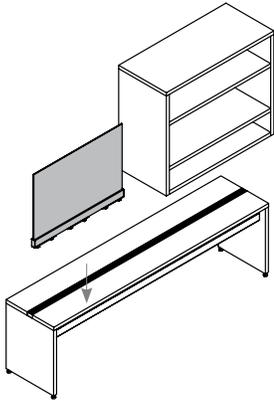

Screens must mount onto an Accessory Beam. Storage can be used on a Simple Stage with an Accessory Beam, the beam will not obstruct the storage.

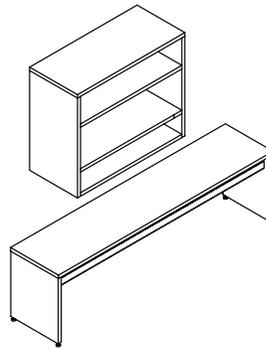

When specifying Stack on Storage only, no Accessory Beam is required.

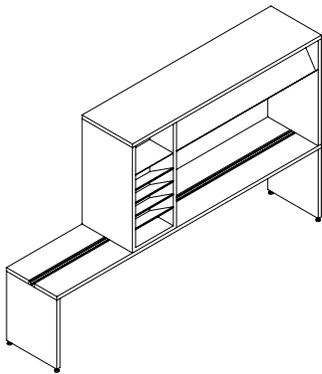

Elevated Hutches and Lateral Towers must mount onto an Accessory Beam.

### grain direction

The grain direction will always run the length of the Simple Stage.

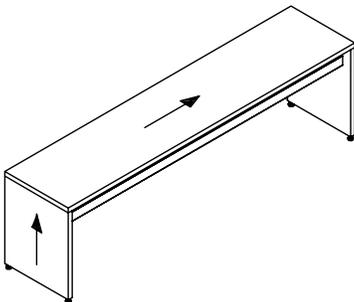

### leveling

To ensure a level Stage, the maximum number of suggested spine structures should not exceed four. Maximum leveling capabilities for each Stage are +2" and -1".

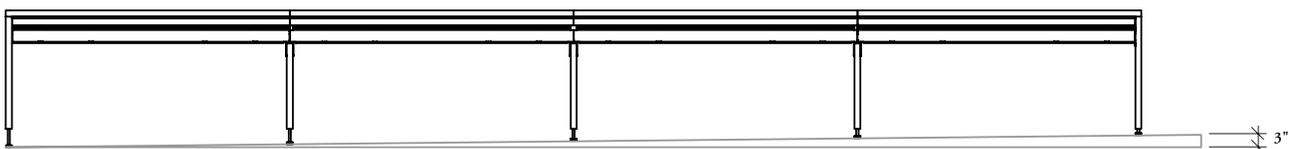

# planning with simple stages (continued)

## connecting simple stages with standard stages

Simple Stages can be connected with Standard Stages with the use of a Stage Connector (HTBA). Only Finish stages at their finished ends or Complete stages can be connected with this connector.

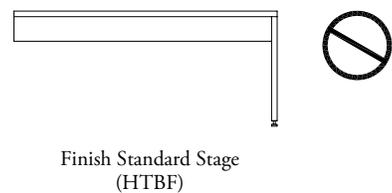
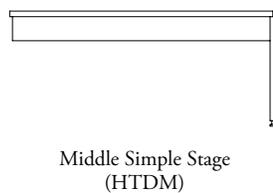
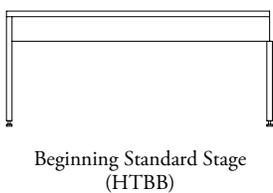
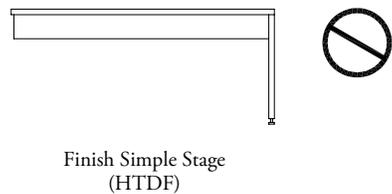
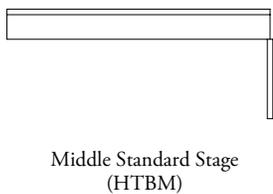
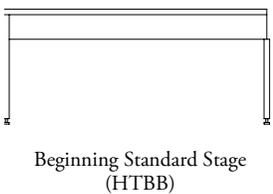
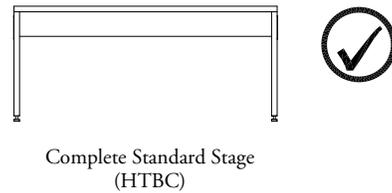
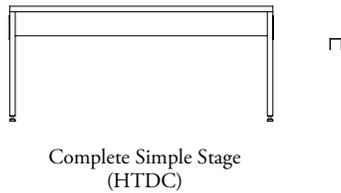
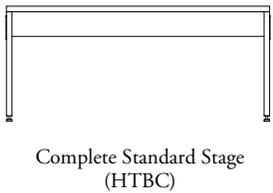
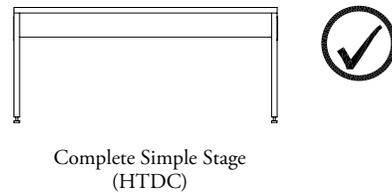
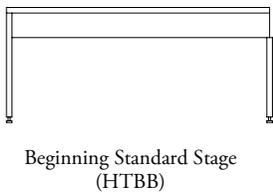
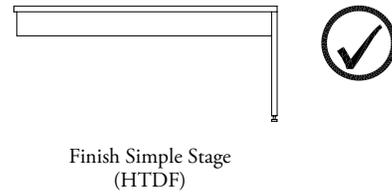
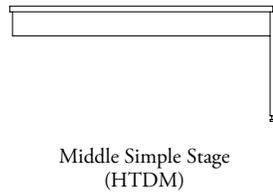
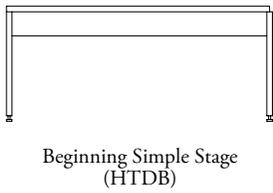
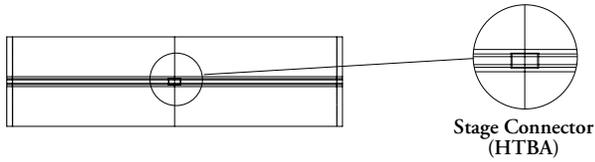

## understanding simple stage electrics

upStage power is distributed through the Simple Stage using a Power Harness and is accessed from both sides in the end or center position.

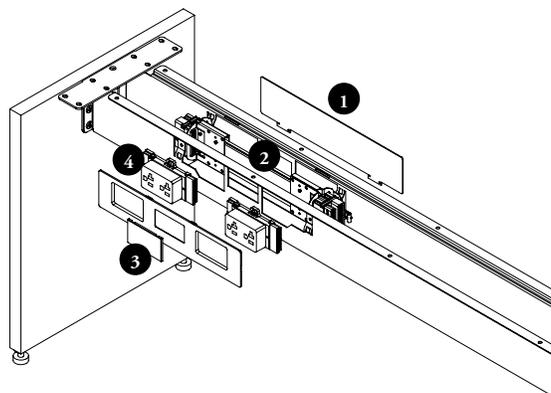

- 1 Simple Stage Blank (HTEK)
- 2 Simple Stage Power Box (HTEFS)
- 3 Standard Data Plate
- 4 Receptacle Outlet (HTERO)

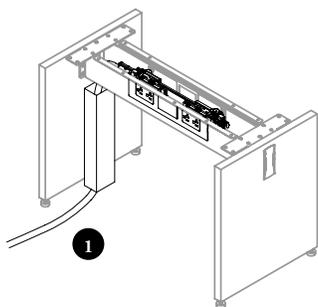

- 1 Base Feed power enters the stage through a Base Feed cover (HTEFB) at the End Gable.

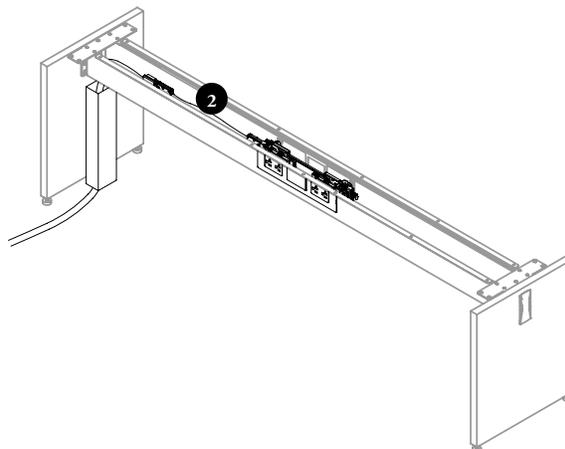

- 2 Power Harnesses routes power to connecting Stages The structure of the Simple Stage allows for cable management for the linking of harnesses, as well as provide a data trough to route data cables. The correct harness lengths must be specified.

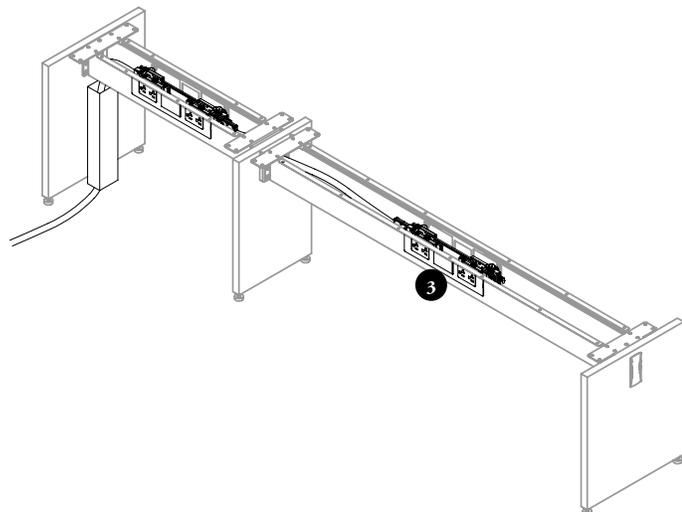

- 3 The simple stage doesn't have a flexible power module, it has a fixed power box.

# simple stage power entry basics

Power can enter a Simple Stage through either a Base Feed or a Ceiling Feed.

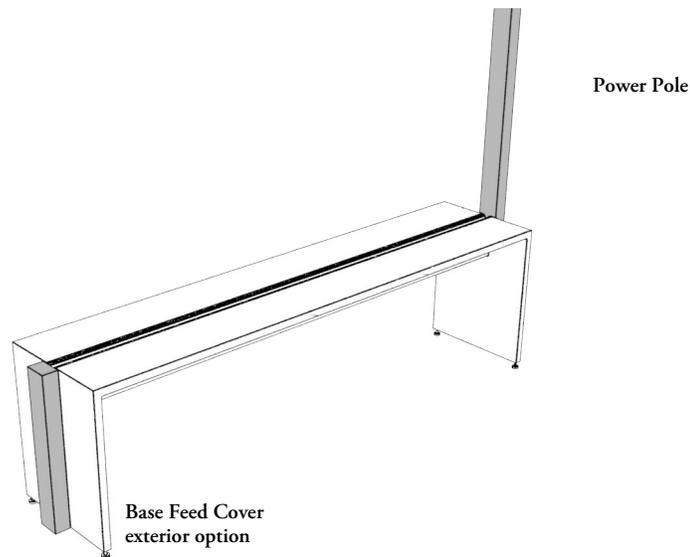

### Ceiling Feed (HTECF)

- Routes power from the ceiling to the workstation
- Wire systems:
  - 8-Wire Isolated Ground (8T)
  - 7-Wire Non Isolated Ground (7T)
  - 8-Wire Dual Isolated (8K)
  - 7-Wire Dual Non Isolated (7K)
- Used with the Power Pole (HTEL)
- Available 120" and 144" long



### Chicago Ceiling Feed (HTECC)

- Required for the city of Chicago electrical code requirements
- Used with the Power Pole (HTEL)
- Available 120" and 144" long



### Power Pole (HTEL)

- Routes a Ceiling Feed and Data Cables from the ceiling to the workstation
- Available in 96", 120" and 144" high
- Finishes available are Foundation, Mica and Accent colors



### Base Feed (HTEBF)

- Routes power from the floor into the stage, then on a Four-Way Splitter
- Wire systems:
  - 8-Wire Isolated Ground (8T)
  - 7-Wire Non Isolated Ground (7T)
  - 8-Wire Dual Isolated (8K)
  - 7-Wire Dual Non Isolated (7K)
- Available (For Stage modules less than 60" or 66" or more)
- When For Stage Module 66" or more option is selected, base feed will come with additional I-Connector and Short Harness to reach the required length



### Split Base Feed (HTEBS)

- Routes power from the floor into the stage, then to a Four-Way Splitter and is wired into the building power source in two locations for New York City wiring restrictions
- Wire systems:
  - 8-Wire Isolated Ground (8T)
  - 7-Wire Non Isolated Ground (7T)
  - 8-Wire Dual Isolated (8K)
  - 7-Wire Dual Non Isolated (7K)
- Available 72" long



### Chicago Base Feed (HTEBC)

- Required for the city of Chicago electrical code requirements
- Available 72" long



### Base Feed Cover (HTEFB)

- Used to route Base Feed and Data Cables into a workstation from the floor
- Applications available are Interior, Mid or Exterior of Stage
- Finishes available are Foundation, Mica and Accent colors

# planning with simple stage power entry

The following should be considered when planning with upStage power entry.

## power poles

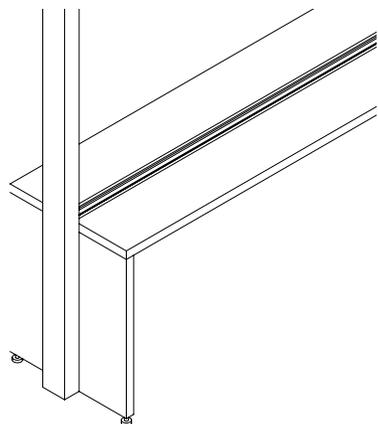

Power Poles mount to the outside of the Simple Stage End Gable only in order to route power and data from the ceiling.

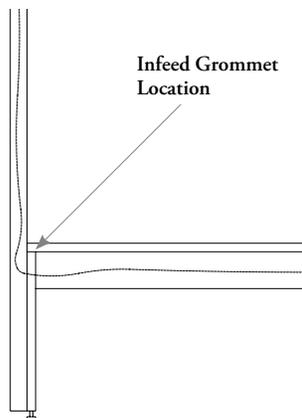

When using a Power Pole, the Simple Stage with an Infeed Grommet must be specified to allow power to enter the stage.

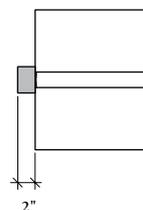

The Power Pole protrudes 2" beyond the Simple Stage gable.

## base feed cover

Mounts to either the outside of an End Gable or the inside of a Mid or End Gable.

### Interior and Mid application

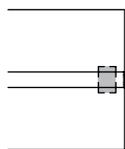
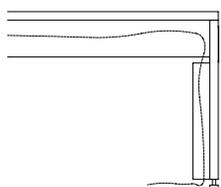

### Outside application

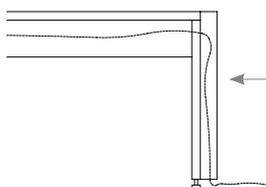

If mounting to the outside of the Simple Stage the Infeed Grommet must be specified.

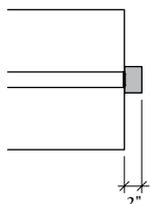

The Base Feed cover will protrude 2" beyond the base.

# planning with simple stage power entry (continued)

## base feed connection

If the Simple Stage is 30" wide, 36" wide or between 72"-96" wide and has "end" electrics, the base feed can connect directly to the Simple Stage Power Box (HTEFS) which is fixed and shared along the spine of the Simple Stage.

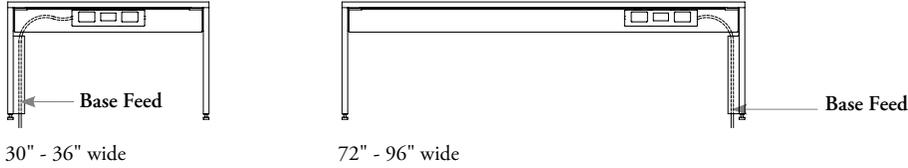

If the Simple Stage is 42"-66" wide, the Base Feed must connect to a Flexible Harness (HTEBH) before connecting to the Simple Stage Power Box (HTEFS).

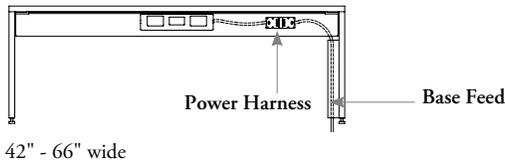

Additional Power Harnesses (HTEB) routes power to connecting stages. The correct length of Power Harness (HTEB) must be specified. See *planning with simple stage power distribution* for more information on specifying harnesses.

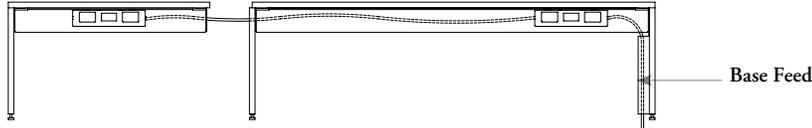

## power box locations

Simple Stage electrics are fixed and double sided which allows for optimization of symmetrical planning.

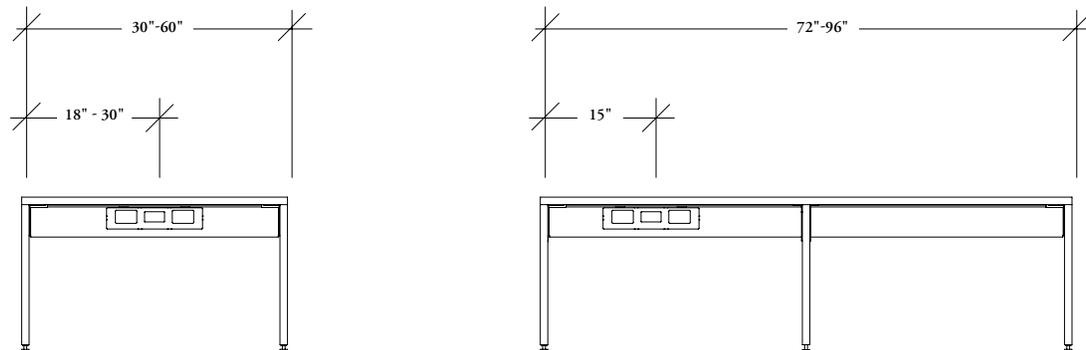

- Centered electrics are only available for Simple Stages 30" - 66" wide
- Electrics are non-handed as they are double sided
- No mid-gable is required

- End electrics only are available for Simple Stages 72" - 96" wide
- Electrics are non-handed as they are double sided
- End electrics can be set at either end by flipping the structure on site, no specification needed
- Center Support is required for simple stages larger than 72". On 72" wide Simple
- Stages that support large amounts of storage, it is recommended that the Stage Center Support be specified for additional support

## understanding simple stage data/communications

The Simple Stage provides various locations for both the Power Harness cable and data cables to be routed within the interior of the Simple Stage.

### stage vs. simple stage data cables capacity

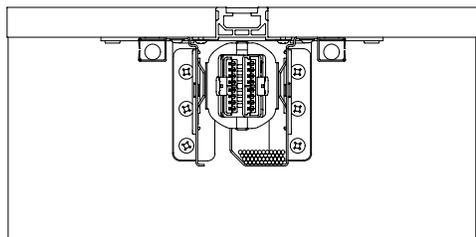

Simple Stage allows for 36 cat 5 data cables (centered).

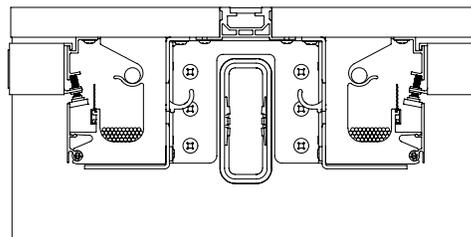

Stage allows for 42 cat 5 data cables (21 per side).



# simple stage power distribution basics

Power is distributed through the Simple Stage with Power Harnesses and accessed with Power Boxes.



Simple Stage Power Box



### Power Harness (HTEBH)

- Routes power through the stage by connecting to a Four-Way Splitter or I-Connector, Simple Power Box
- Wire system:
  - 8-Wire Isolated Ground (8T)
  - 8-Wire Dual Isolated (8K)
- Lengths: 18" - 144" in 6" increments



### Receptacle Outlet (HTERO)

- Mounts onto the Simple Stage Power Box to provide access to power
- Outlet Configurations
  - Circuit 1
  - Circuit 1 and 2
  - Circuit 1 and 3 (use 8T only)
  - Circuit 1 and 5
  - Circuit 1 and 6 (use 8K only)
  - Circuit 2 and 2
  - Circuit 2 and 3 (use 8T only)
  - Circuit 2 and 5
  - Circuit 2 and 6 (use with 8K only)
  - Circuit 3 and 3 (use 8T only)
  - Circuit 3 and 5 (use 8T only)
  - Circuit 5 and 5
  - Circuit 5 and 6 (use 8K only)
  - Circuit 6 and 6 (use 8K only)



### Simple Stage Power Cover (HTEK)

- A blank plate to cover unused opening in power ports



### Simple Stage Power Box (HTEFS)

- Compatible Wiring Systems:
  - 8-Wire Isolated (8T)
  - 8-Wire Dual Isolated (8K)
  - 7-Wire Non-Isolated (7T)
  - 7-Wire Non-Dual Isolated (7K)
- Finishes:
  - Soft Gris
  - Very White
- Receptacle Outlet (HTERO) must be specified separately



### Data Extender Plate (HTEEE)

- Placed over a communication opening to provide extended depth for data jack



### Simple Stage Data Cover (HTEZ)

- A blank plate to cover unused opening in data ports

# planning with simple stage power distribution

## power harness lengths

When specifying the harnesses for Simple Stages, the correct length must always be calculated. Power Harness calculations must account for the length of the Power Module which is 12" wide. For Stages 72" or wider, the distance of the center of the Power Module to the end of the stage is 15". For Stages 30"-60" the Power Module is centered. For example, in the following example a 72" beginning stage, a 60" middle stage and a 60" finish stage has been specified. The length of the Harness is calculated as followed:

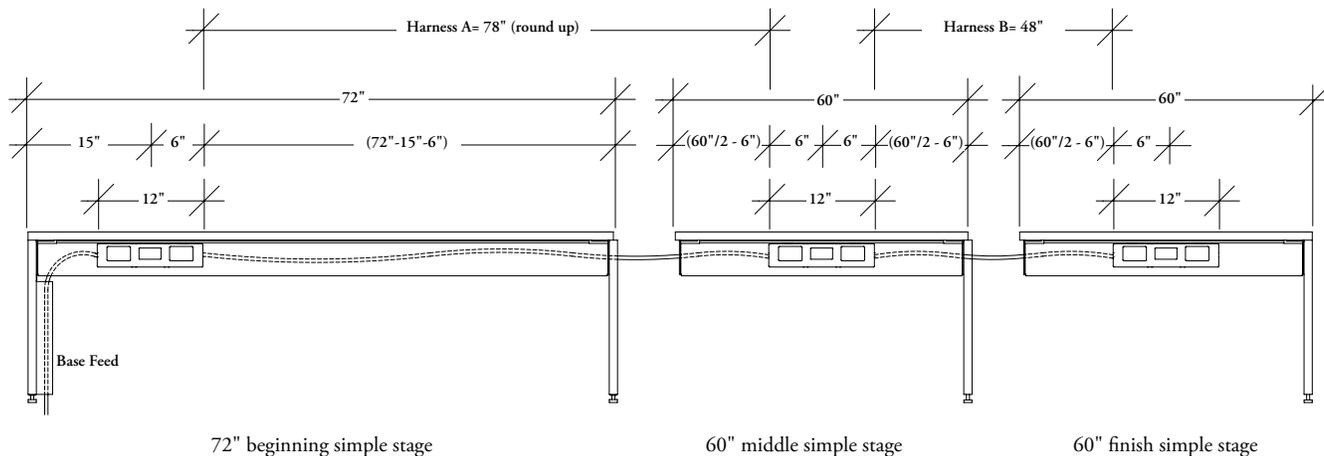

$$\text{Harness A} = (\text{Beginning stage dimension} - 15" - 6") + (\text{stage dimension} / 2 - 6")$$

$$\text{Harness B} = (\text{Middle stage dimension} / 2 - 6") + (\text{End stage dimension} / 2 - 6")$$

# power conservation system basics

Furniture based solution for the controlling function that addresses the ASHRAE/Title 24 electrical requirements.

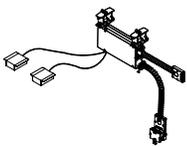
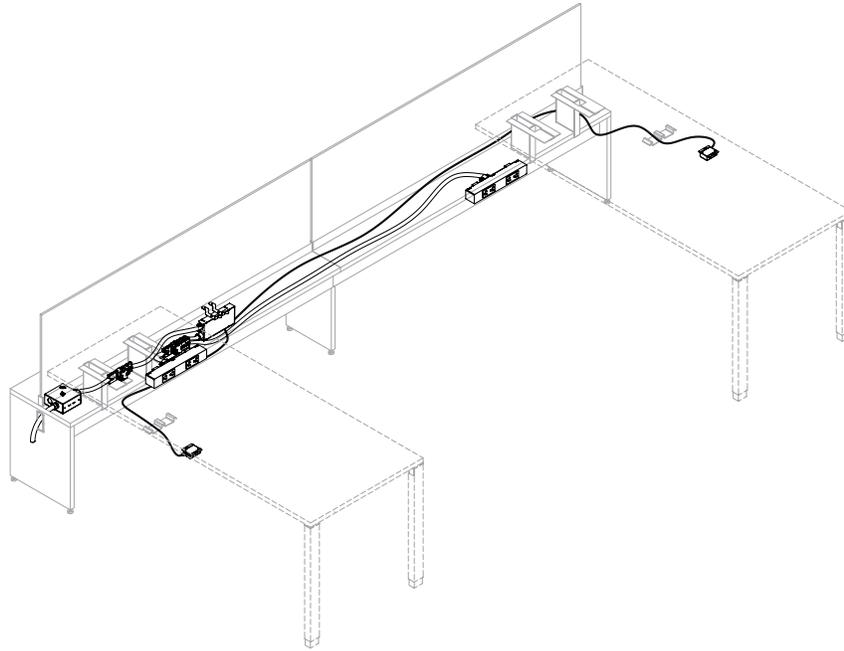

## Power Conservation System (HTEPC)

- Up to two circuits can be controlled by occupancy sensors (included)
- Maximum of 4 sensors can be connected to each individual controlled circuit
- When using the Power Conservation System, circuits 3, 5, 6, A and B will always stay powered on (uncontrolled)
- To get individually controlled stations, specify the Power Conservation System with 2 sensors
- Available with option of 2, 4 or 8 sensors (Maximum of 4 sensors per run)
- Sensors mount to the underside of the worksurface
- A hard wired connection supplies power into a stage from the building power source

## planning with power conservation system

The following should be considered when planning with the Power Conservation System.

The following are two ways of planning with the Power Conservation System.

### scenario A: multiple sensor planning

The connection between two power modules only applies on the installation for 4 sensors and 8 sensors.

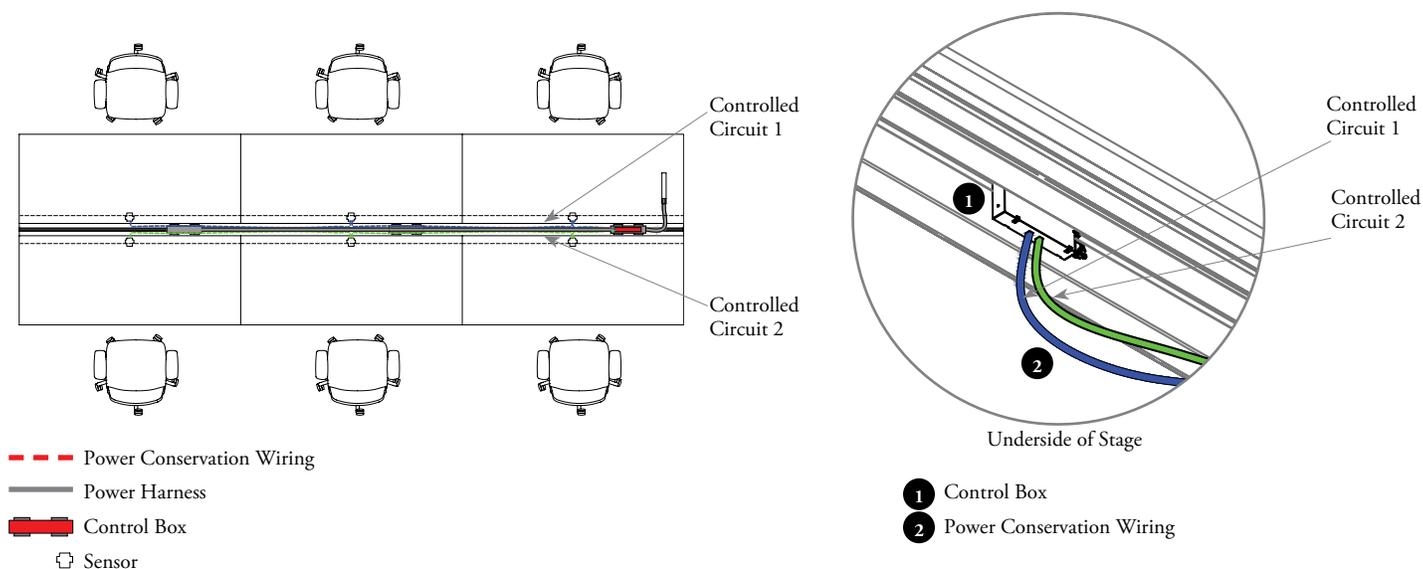

### scenario B: single sensor planning

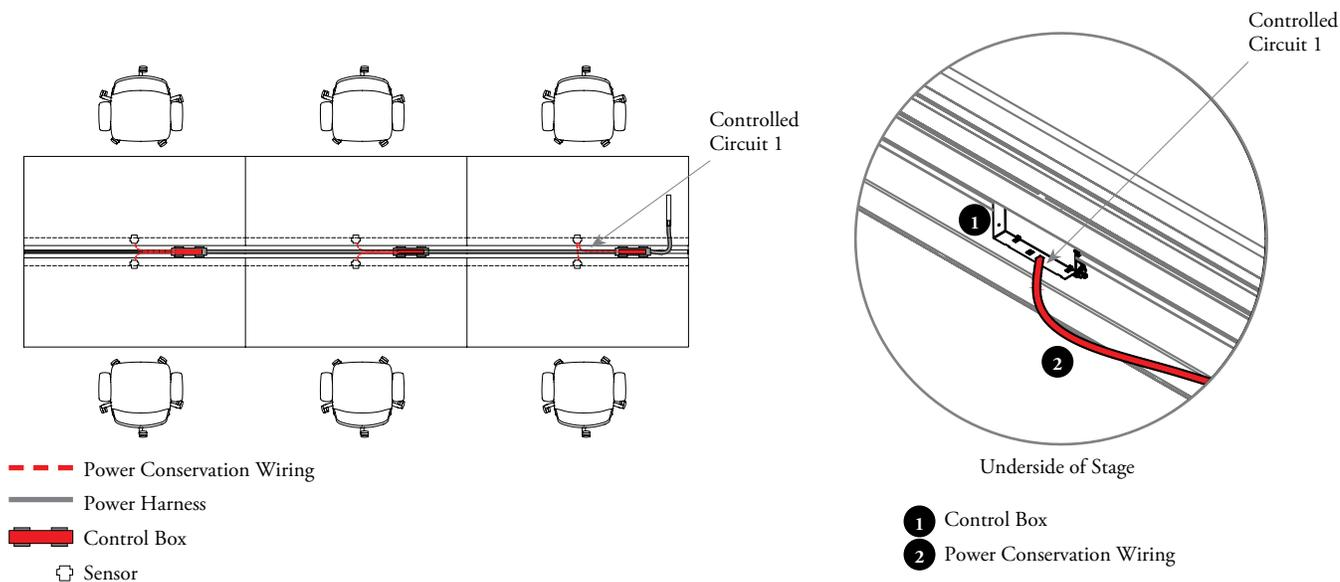

- Always specify one sensor per workstation.
- Only one controlled circuit per workstation (do not specify two controlled circuits in one single workstation)
- Do not specify mix receptacles for both circuit 1 and 2 in a single workstation



worksurfaces &  
supports

# worksurfaces & supports

UNDERSTANDING WORKSURFACES . . . . .	56
WORKSURFACE BASICS . . . . .	58
TABLE BASICS . . . . .	59
PLANNING WITH WORKSURFACES . . . . .	60
WORKSURFACE POWER ACCESS BASICS . . . . .	65
WIRE MANAGEMENT BASICS . . . . .	66
PLANNING WITH WORKSURFACE POWER ACCESS . . . . .	67
WIRING SYSTEMS . . . . .	70
WORKSURFACE GRAIN/PATTERN DIRECTION . . . . .	71
WORKSURFACE SUPPORTS & ACCESSORY BASICS . . . . .	72
PLANNING WITH WORKSURFACE SUPPORTS . . . . .	73

## understanding worksurfaces

upStage offers a variety of workstations for parallel and perpendicular applications. They can be mounted directly to the Stage, storage units or hutch stackers in a semi-suspended application or specified with legs to create freestanding tables. Navigate + hiSpace can also be integrated with upStage.

### parallel and perpendicular worksurfaces

When no hutches or stacked storage are used worksurfaces are typically mounted 2" from the centerline of the stage. The gap is required to allow for the placement of screens on the stage and for cable management.

#### Parallel

Worksurfaces face the Stage



Standard Parallel Planning

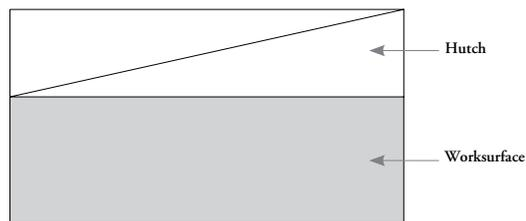

Parallel Planning with Hutches

(When mounting parallel to a Hutch, there is no gap)



Back to Back Parallel Planning

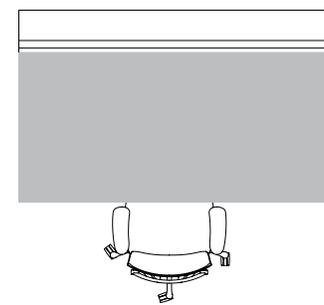

Single Sided Planning

#### Perpendicular

Worksurfaces run perpendicular to the Stage

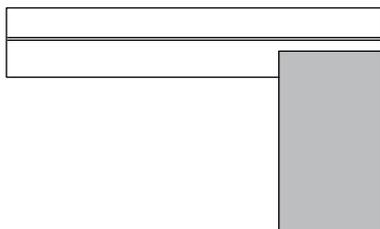

Standard Perpendicular Planning

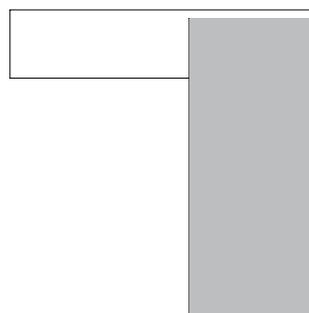

Single Sided Perpendicular Planning

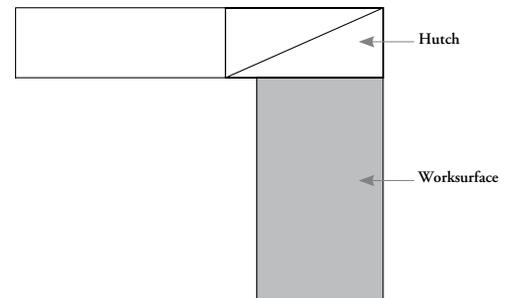

Perpendicular Planning with Hutches

(When mounting perpendicular to a Hutch, there is no gap)



# understanding worksurfaces (continued)

## navigate and hispace table integration

Navigate and hiSpace Tables are available with an upStage leg option.

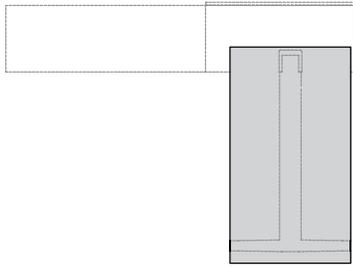

### Navigate and hiSpace Tables Integrated with stages

- The leg fits into the Stage Module for Height-Adjustable Table to conceal the leg

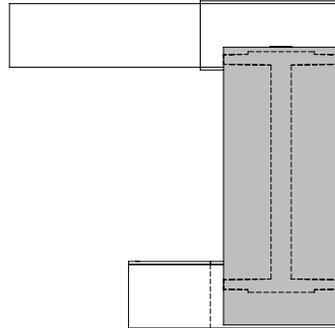

### Navigate Tables Integrated with Credenzas

- The leg fits into the credenza for Height-Adjustable Table to conceal the leg

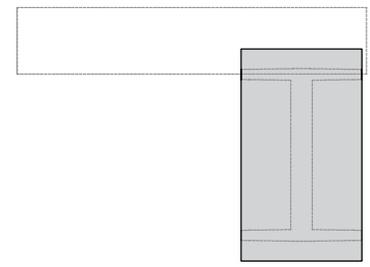

### Navigate and hiSpace Freestanding

- Designed to sit the leg against the stage in freestanding applications

## freestanding tables

Freestanding tables are available with Interpret legs or Y-legs.

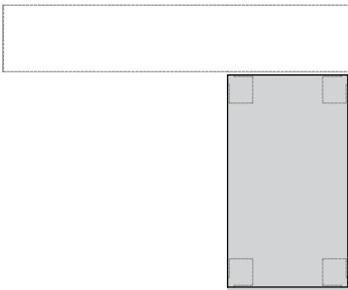

### Freestanding Table

- The table sits beside the stage

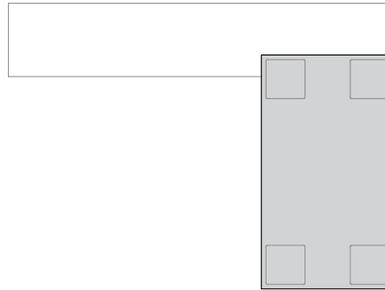

### Y-table

- The shape of the leg allows the table to overlap the stage



Worksurfaces can be mounted perpendicular or parallel over the stage with no gap in between to create a large shared worksurface .

Perpendicular

Parallel

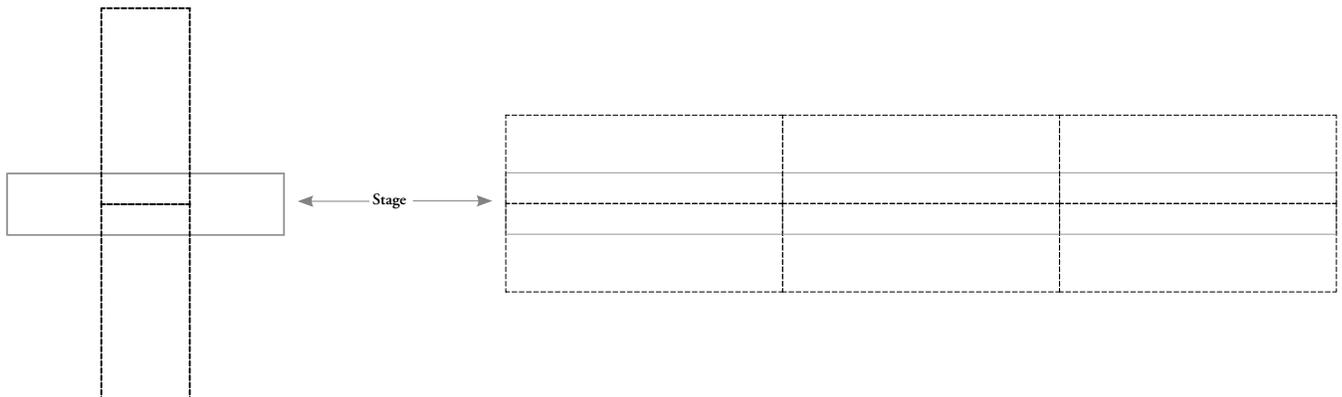

## worksurface basics

upStage worksurfaces are available for parallel and perpendicular applications to optimize “zero footprint” planning.

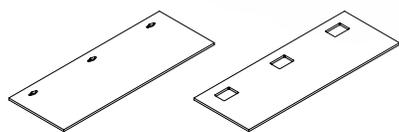
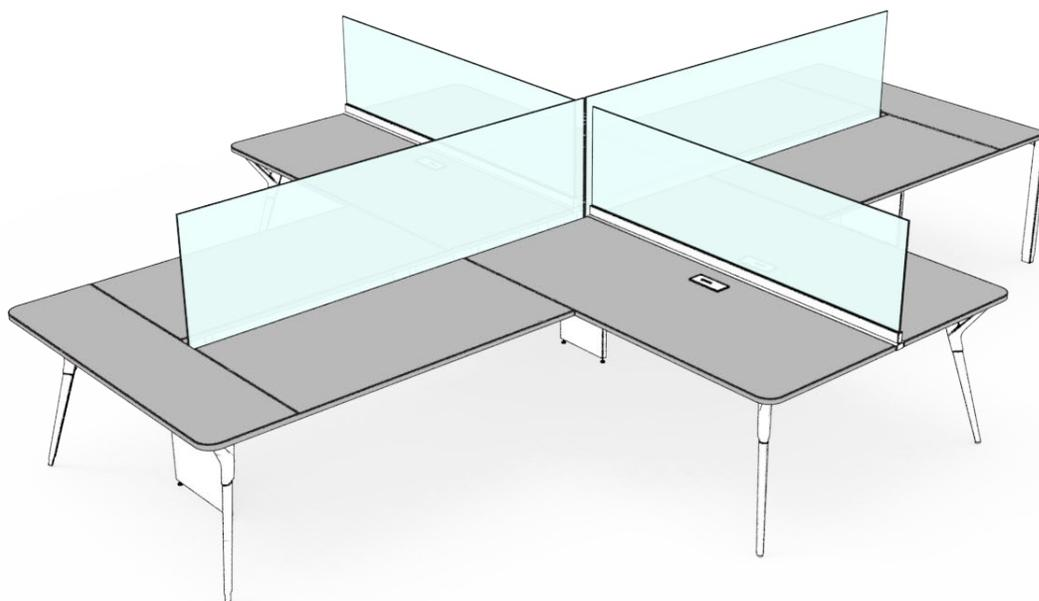

### Parallel Worksurface (HTWR)

- Runs parallel to the stage or can be used freestanding when configured with legs (see *Supports* section for details)
- Depths: 23", 29" and 35"
- Widths: 30", 36" and 42" to 96" in 1" increments
- All dimensions are actual
- Available with Access Door or Rectangular Cut Outs
- Access door Cut Out options are not available for 23" depth worksurface

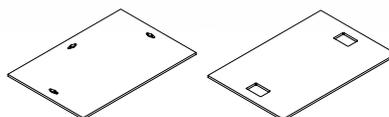

### Perpendicular Worksurface (HTWP)

- Runs perpendicular from the stage or can be used freestanding when configured with legs (see *Supports* section for details)
- Depths: 24" - 48" in 6" increments
- Widths: 46" - 71" in 1" increments
- All dimensions are actual
- Available with Access Door or Rectangular Cut Outs

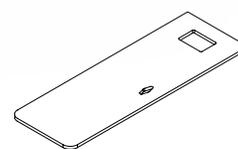

### Perpendicular with Radius Corner Worksurface (HTWH)

- Runs perpendicular from the stage
- Depths: 24" - 48" in 6" increments
- Widths: 46" - 71" in 1" increments
- All dimensions are actual
- Available with Access Door or Rectangular Cut Outs
- Available with two or four radiused corners

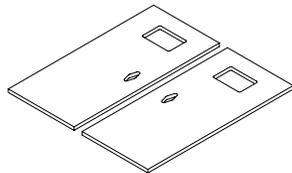

### Dual Perpendicular Worksurface (HTWV)

- Two face to face worksurfaces
- Wire gap and flush profiles available
- Depths: 48", 60" and 72"
- Widths: 46" to 71" in 1" increments
- All dimensions are actual
- Available with Access Door or Rectangular cut outs
- Access door cut out options are not available for 23" depth worksurface
- Round 3" radius corner profile

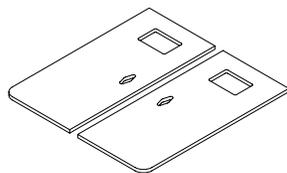

### Dual Perpendicular with Radius Corner Worksurface (HTWW)

- Two face to face worksurfaces
- Wire gap and flush profiles available
- Depths: 48", 60" and 72"
- Widths: 46" - 71" in 1" increments
- All dimensions are actual
- Available with Access Door or Rectangular cut outs
- Access door cut out options are not available for 23" depth worksurface
- Available with two or four radius corners

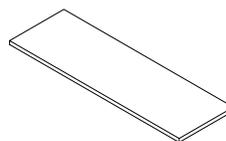

### End Worksurface (HTWG)

- Two face to face worksurfaces
- Wire gap and flush profiles available
- Depths: 16"
- Widths: 50", 62" and 74"
- All dimensions are actual

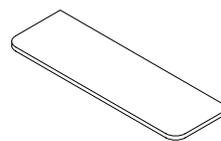

### End with Radius Corners Worksurface (HTWZ)

- Provides an end worksurface to a dual perpendicular worksurface
- Depths: 16"
- Widths: 50", 62" and 74"
- All dimensions are actual
- Round 3" radius corner profile

# table basics

upStage workspaces are available for parallel and perpendicular applications to optimize “zero footprint” planning.

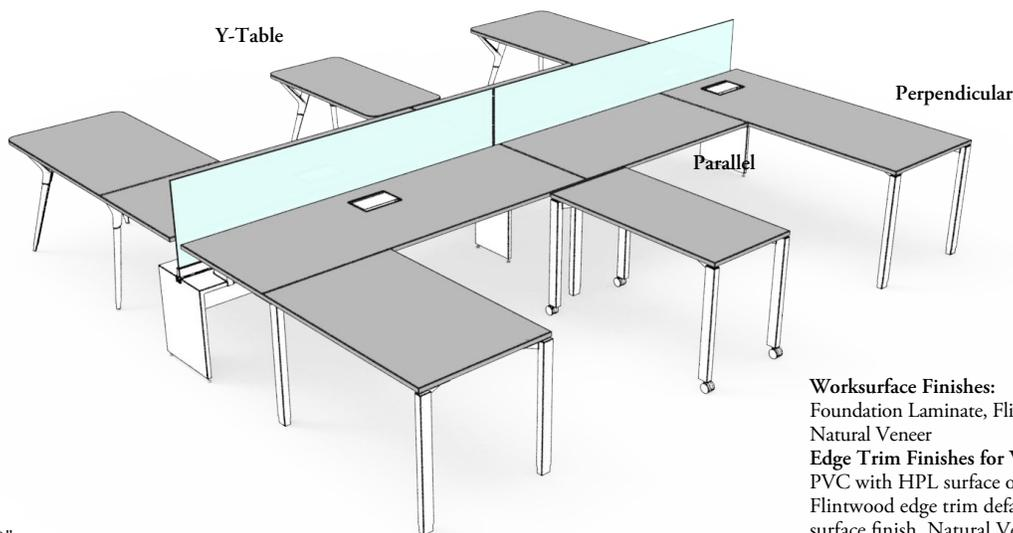

**Worksurface Finishes:**  
Foundation Laminate, Flintwood and Natural Veneer  
**Edge Trim Finishes for Worksurface:**  
PVC with HPL surface only, Acrylic with HPL, Flintwood edge trim defaults to Flintwood surface finish, Natural Veneer edge trim defaults to Natural Veneer surface finish

- Widths: 46" - 70"
- Depths: 23", 29" and 35"
- Available with Access Door option or Rectangular Cut Outs option
- Worksurface finishes: Foundation Laminate, Flintwood and Natural Veneer
- 23" deep tables are not available in 70" wide
- 29" and 35" deep tables are not available in 46" wide
- Rectangular Grommet Cut Outs and Access Door for Multi-Circuit Desk Cut Outs have size restrictions:
  - On Parallel worksurface widths less than 42" and specified with the Access Door, only the center location is available.
  - Access Door **cannot** be specified on the Y-Table (HTWE)
  - Access Door **cannot** be specified on parallel worksurfaces if the depth is less than 29".
  - Access Door Cut Out options Left and Right and the Rectangle Cut Out options Left and Right are not available on 30" and 36" wide parallel worksurfaces

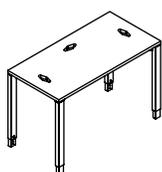

**Interpret Style Table (HTWT)**

- A freestanding table with Interpret legs
- Fixed Height has a leveling range of +1 and -1
- Height-Adjustable available with a (+3" and -3" range)
- All dimensions are actual
- Available with or without casters
- Leg finishes: Foundation, Mica and Accent colors

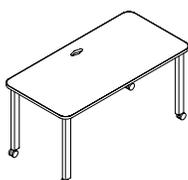

**Interpret Table Radius Corner Table (HTWU)**

- A freestanding table with Interpret legs
- Round 3" Radius corner profile
- Fixed Height has a leveling range of +1 and -1
- Height-Adjustable available with a (+3" and -3" range)
- All dimensions are actual
- Available with or without casters
- Leg finishes: Foundation, Mica and Accent colors



**Y Table (HTWE)**

- A freestanding table featuring Y-Legs
- Y-Legs are available in two finish options
  - Wood & Metal (Upper support metal and lower support wood)
  - Metal & Metal (Upper and lower supports metal, can specify different metal finishes)
- Wood & Metal option offers an adjustment range of + 1/2" and - 1/2"
- Metal & Metal option offers an adjustment range of + 2" and - 1"
- Available without casters only
- Metal finishes: Foundation, Mica and Accent colors
- Wood support finishes are Flintwood and select Natural Veneer coordinate



**Y Table with Radius Corner (HTWX)**

- A freestanding table featuring Y-Legs
- Round 3" Radius corner profile
- Y-Legs are available in two finish options
  - Wood & Metal (Upper support metal and lower support wood)
  - Metal & Metal (Upper and lower supports metal, can specify different metal finishes)
- Wood & Metal option offers an adjustment range of + 1/2" and - 1/2"
- Metal & Metal option offers an adjustment range of + 2" and - 1"
- Available without casters only
- Metal finishes: Foundation, Mica and Accent colors
- Wood support finishes: Flintwood and select Natural Veneer coordinate

## planning with worksurfaces

The following should be considered when planning with upStage worksurfaces mounted to the Stage.

### parallel worksurfaces

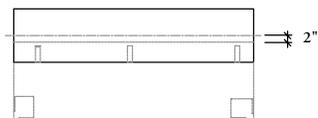

When specifying parallel work surfaces, it is recommended that all work surfaces be mounted 2" from the centerline of the stage, which allows for a 6" overhang over the stage.

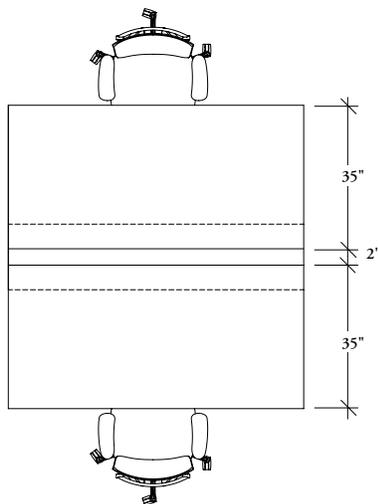

2" wire gap required when planning single sided.

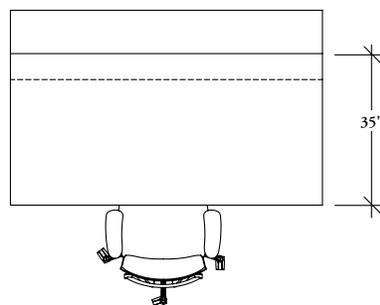
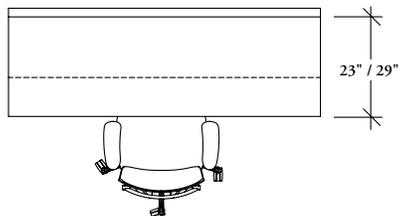

### perpendicular worksurfaces

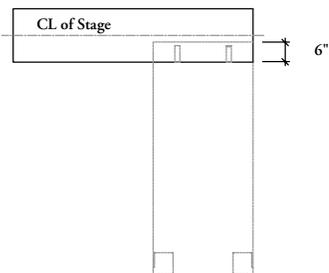

When specifying Perpendicular worksurfaces, it is recommended that all worksurfaces be mounted 2" from the centerline of the stage, which allows for a 6" overhang over the stage.

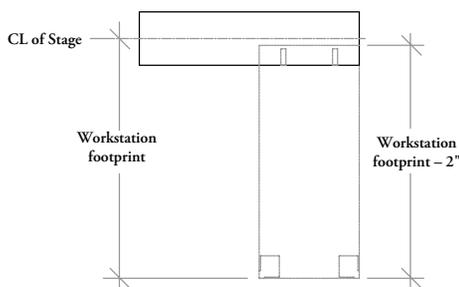

To allow for "zero footprint" planning, perpendicular worksurfaces should be planned 2" less than the desired footprint.

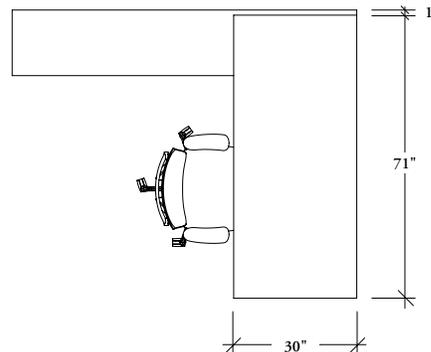

1" wire gap required when planning perpendicular worksurfaces.

# planning with worksurfaces (continued)

The following should be considered when planning with upStage worksurfaces mounted to the Stage.



If a common kit of parts is desired, "zero footprint" planning can still be achieved, however there will be minor variances between widths and depths of worksurface.

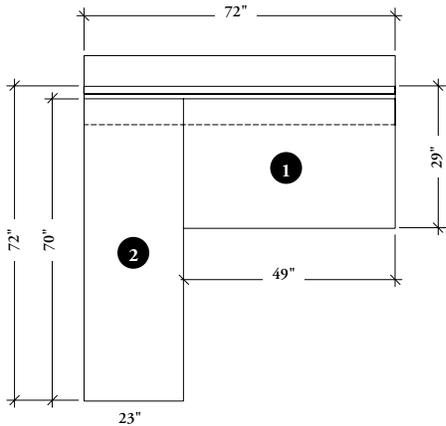

parallel worksurfaces

- 1 49" wide x 29" deep
- 2 70" wide x 23" deep

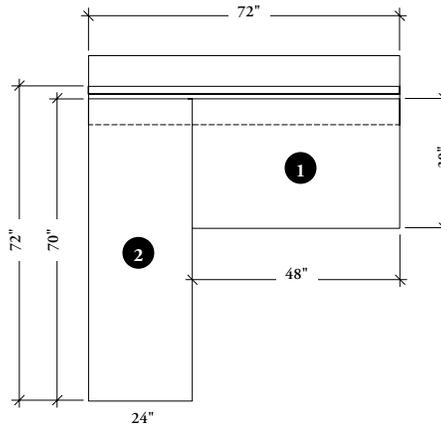

perpendicular worksurface

- 1 48" wide x 30" deep
- 2 70" wide x 24" deep

When combining parallel and perpendicular worksurfaces, both worksurfaces must be mounted to the stage, a perpendicular worksurface **cannot** be mounted to a parallel worksurface.

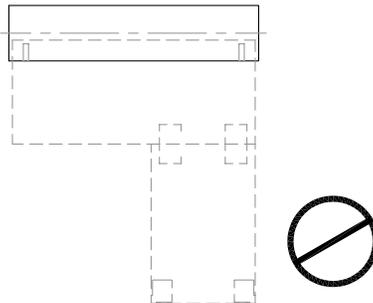
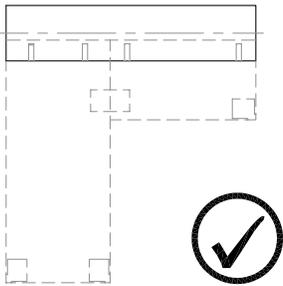

# planning with worksurfaces (continued)

## freestanding tables

The Interpret table is available with Flat and Knife edges. Y Table is only available with Flat edges.

### Flat Edge

On Flat Edge worksurfaces, the legs are flush to the worksurface edge.

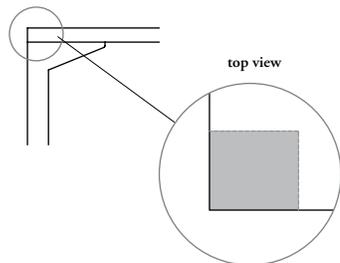

### Knife Edge

On Knife Edge worksurfaces, the legs are inset by 1".

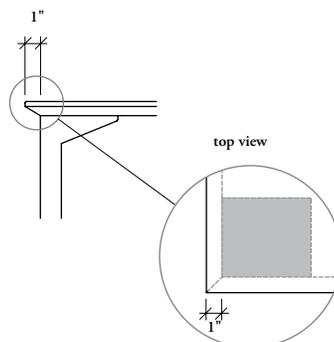

## planning with worksurfaces mounted to hutch stackers or storage

Worksurfaces can be mounted to hutches or storage on the stage (see Storage section for more details). When mounting a perpendicular worksurface to a hutch, the hutch depth must be taken into consideration when determining the width of the surface.

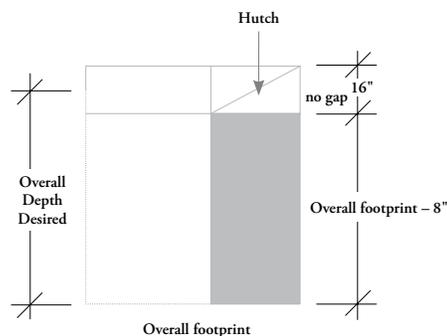

When a worksurface is specified against hutch storage there will be no gap the worksurface must be specified 8" less then the desired footprint size.

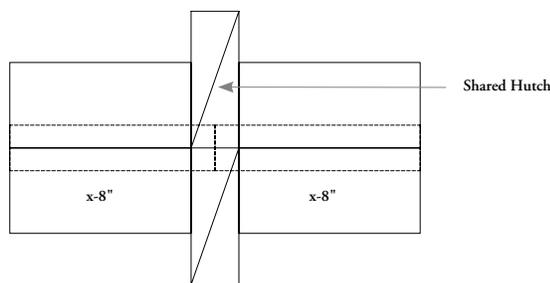

When planning parallel worksurfaces with a shared Hutch each the worksurface will have to be 8" less then the stage width to accommodate the Shared Hutch Stacker.

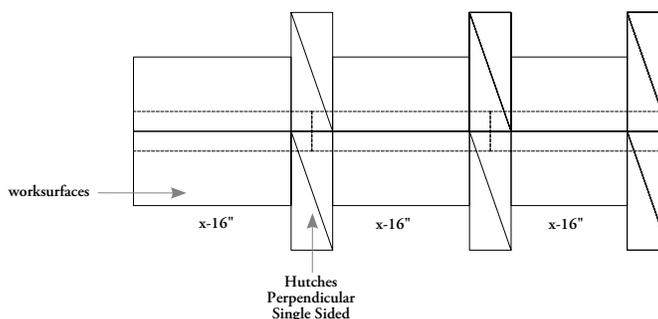

When planning parallel worksurfaces with Hutches note your worksurface will have to be 16" less then the stage width to accommodate the Hutch Stackers.

# planning with worksurfaces (continued)

## planning with lateral screens

upStage parallel worksurfaces are available in 1" widths to allow for the placement of lateral screens between worksurfaces. Lateral Screens are offset to the left or right, they are not centered between two Stages.

When a lateral Screen is not required on either end of a worksurface, the worksurface is specified the same width as the stage.

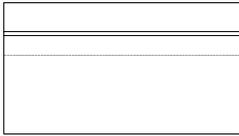

When a Lateral Screen is not required between two worksurfaces, the worksurfaces are specified the same widths as the stages.

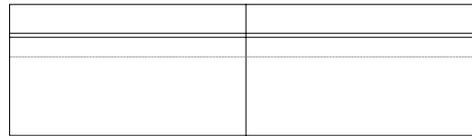

When a lateral screen is being specified between two worksurfaces allow 1" for the thickness of the screen and a additional 1" gap on either side.

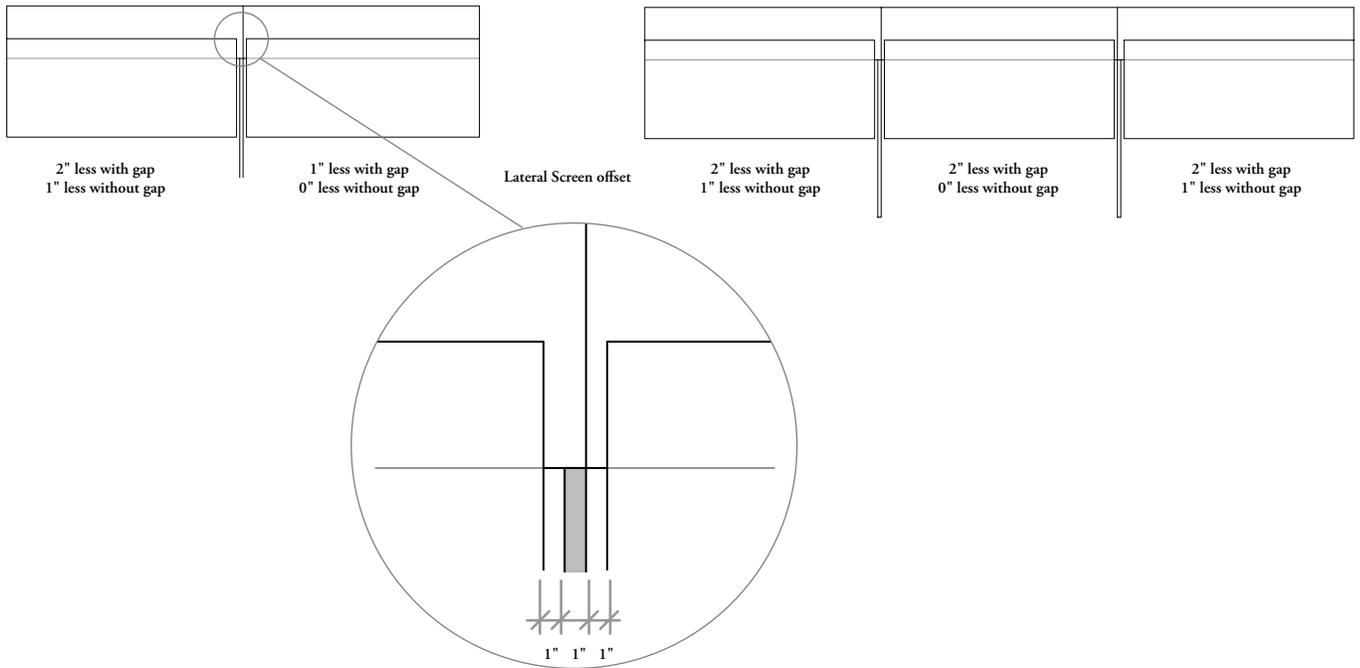

## planning with worksurfaces (continued)

### planning with dual perpendicular worksurfaces and elevated hutches

When planning with the Dual Perpendicular Worksurface and Elevated Hutch, the Support Kit can accommodate the Elevated Hutch gables.

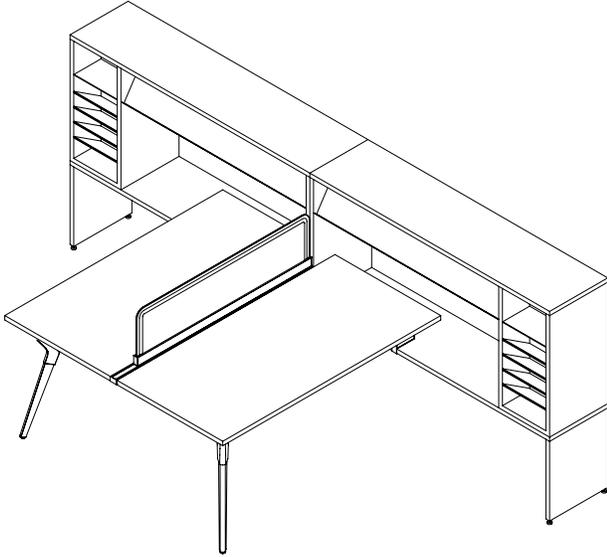

The accessory rail between the two worksurfaces will be shorter to allow for the gables of the elevated hutch.

### planning with worksurfaces with radius corners

Worksurfaces with radiused corners allow for planning with the Infinity Desk Edge Screen to offer a softer aesthetic

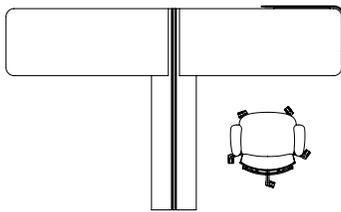

#### Side by Side Planning

- Worksurfaces have two curved corners and two straight corners

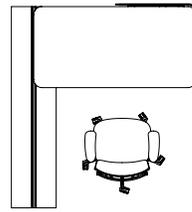

#### Single Side Planning'

- Worksurfaces have two curved corners



# workspace power access basics

Multi-Circuit power is available for semi-suspended worksurface applications. Worksurfaces must be specified with Access Door Cut Out to access the power.

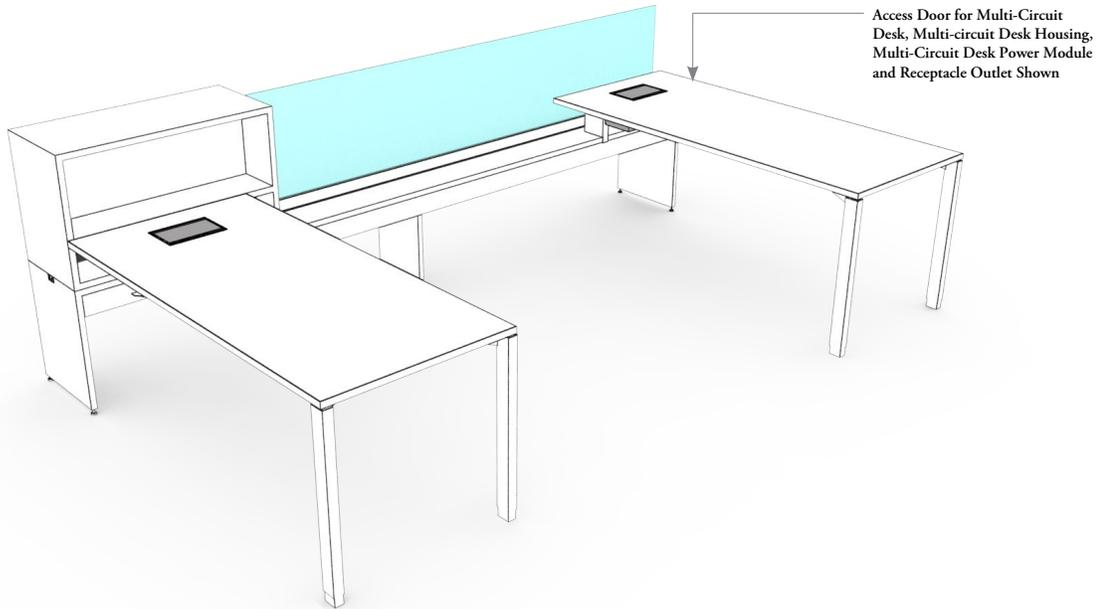

### Multi-Circuit Desk Power Module (HTEM)

- Mounts inside of a multi-circuit desk housing to provides access to power on semi-suspended worksurfaces
- Wire system:
  - 8-Wire Isolated Ground (8T)
  - 8-Wire Dual Isolated (8K)



### Chicago Desk Power Module (HTEMC)

- Provides access to power on semi-suspended worksurfaces in Chicago applications

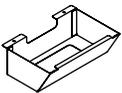

### Multi-Circuit Desk Housing (HTEN)

- Provides the housing required to support the Multi-Circuit Desk Module
- Finishes: Foundation, Mica and Accent colors



### CALA Power Station (VBWB)

Mounts to a worksurface to provide power

#### Outlet Configurations:

- Double duplex
  - Two Power & Two Data
  - Four Power
  - Three Power & One USB

#### Country of Installation:

- R Argentina
- N Brazil
- L Chile

**Cord Length:**  
1800 mm

#### Finishes

**Receptacle Finish:**  
Ebony Coordinate  
Very White Coordinate

**Clamp Finish:**  
Clear Anodized Aluminum



### Receptacle Outlet (HTERO)

- Mounts onto the Power Module or in the Multi-Circuit Desk Module or to the Power Module in a Height-Adjustable Module
- Styles: Standard 15 amp, T-Slot 20 amp, Controlled 15 and 20 amp
- Outlet configurations consist of Circuit 1, Circuit 2, Circuit 3 (use 7T & 8T only), Circuit 5 (8T and 8K only), Circuit 6 (use 8K only), Circuit A (7T and 7K only) and Circuit B (7K only)
- Receptacle style D and E include a marking indicating it is connected to a control system.
- Finishes: Platinum, Ebony, Storm White and Very White



### Access Door for Multi-Circuit Desk (HTEA)

- Provides the above worksurface access to the outlets on the Multi-Circuit Desk Module
- Finishes: Foundation, Mica and Accent colors

## wire management basics

Wire management components are specified to route and manage cables below the worksurface.

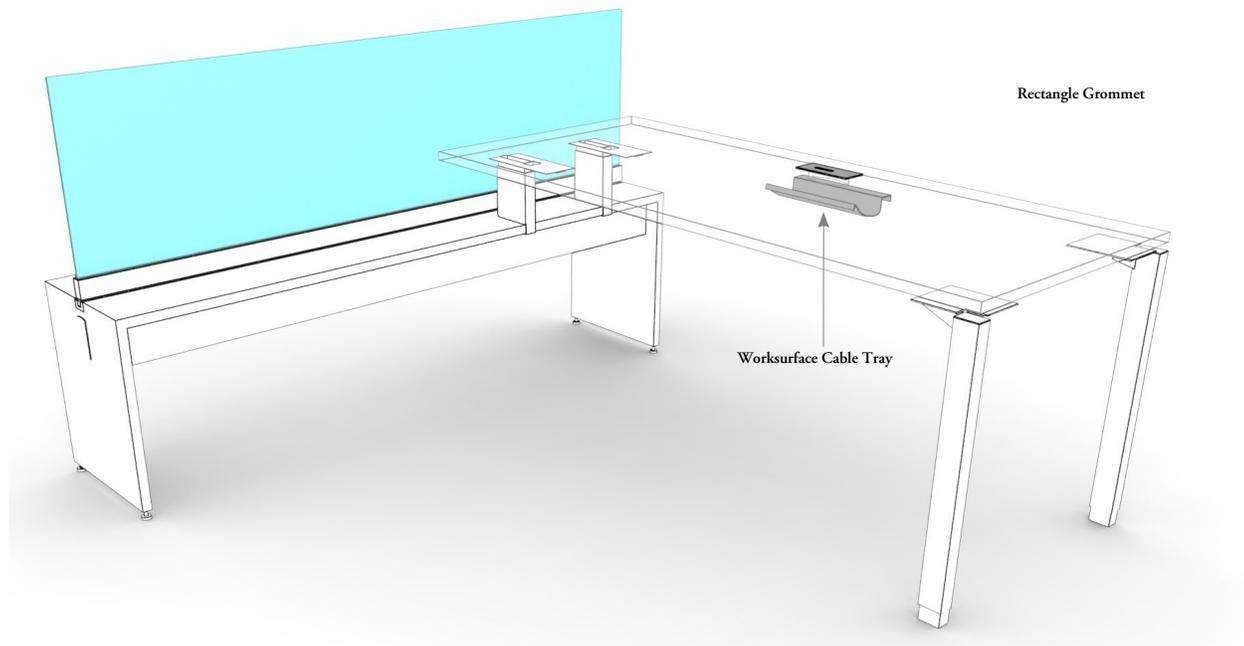

### Rectangle Grommet (HTEG)

- Provides worksurface pass through wire management
- Finishes: Clear Anodized Coordinate, Graphic Steel, Storm White, Very White and Platinum



### Worksurface Cable Tray (HTET)

- Provides wire management below worksurface
- Length: 12"
- Available in Black only



### Wire Clips (HTEW)

- Provides management below the worksurface
- Package includes six clips
- Available in Black only



### International Stage Mount Kit (VES)

A bracket that holds International electrics to the stage

#### Mounting styles:

- Power Logic
- CALA

#### Bracket Packages:

- For Two Outlet Box
- For Four Outlet Box

# planning with worksurface power access

The following should be considered when planning with Worksurface Power Access.

## worksurface power and data management

Worksurfaces can be specified with a Rectangle Cut Out or an Access Door Cut Out. Two options are available for accessing power at desk level.

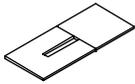

### Rectangle Grommet

The Rectangle Grommet (HTEG) routes power through the worksurface to the Flexible Power Module specified on the stage and must be ordered separately.

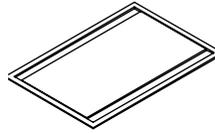

### Access Door for Multi-Circuit Desk

The Access Door for Multi-Circuit Desk (HTEA) is used with the Multi-Circuit Desk Module (HTEM) and housing to provide multi-circuit power from the worksurface. A worksurface with Access Door Cut Out must be specified. All components need to be specified separately.

## multi-circuit desk power

The Multi-Circuit Desk Housing (HTEN), Multi-Circuit Desk Power Module (HTEM), Receptacle Outlet (HTERO) and Access Door for Multi-Circuit Desk (HTEA) are all specified separately. Multi-Circuit Desk Power is only available with Standard Stages and cannot be specified with Simple Stages.

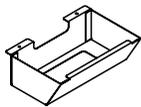

Multi-Circuit Desk Housing (HTEN)

+



Multi-Circuit Desk Power Module (HTEM)

+



Receptacle Outlet (HTERO)

+



Access Door for Multi-Circuit Desk (HTEA)

=

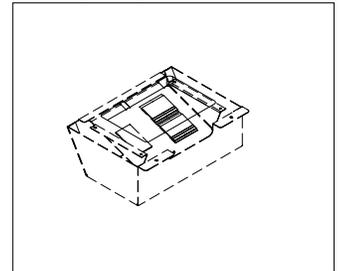

## perpendicular worksurfaces

Rectangular Grommet Cut Out are available left, right and center.

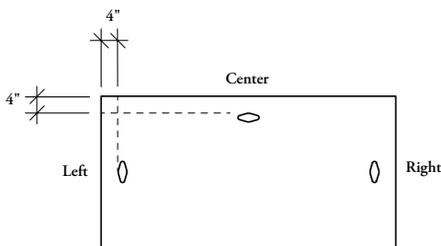

Rectangle Cut Out is inset 4" from the edge of the worksurface.

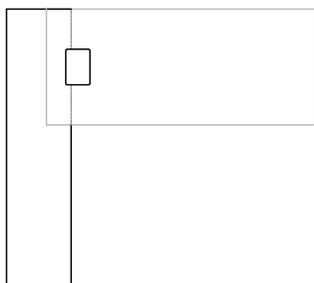

Access Door for Multi-Circuit Desk can be specified on worksurfaces that are semi-suspended from the stage.

Access Door for Multi-Circuit Desks are available left and right.

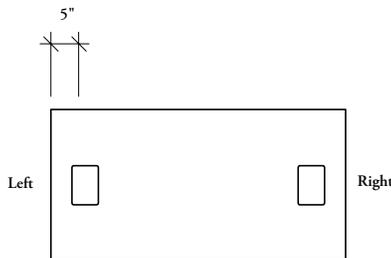

Access Door Cut Outs are inset 5" from the edge of the worksurface.

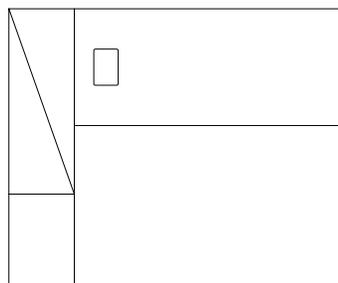

Access Door for Multi-Circuit Desk can be specified on worksurfaces that are attached to a Hutch Stacker.

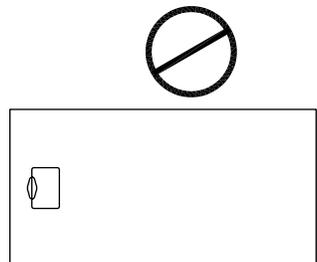

\*If an Access Door Cut Out is specified, a left or right Rectangular Cut Out **cannot** be specified in the same location

# planning with worksurface power access (continued)

The Multi-Circuit Desk Module must be used in a semi-suspended application. The following examples demonstrate how power routes to the module.

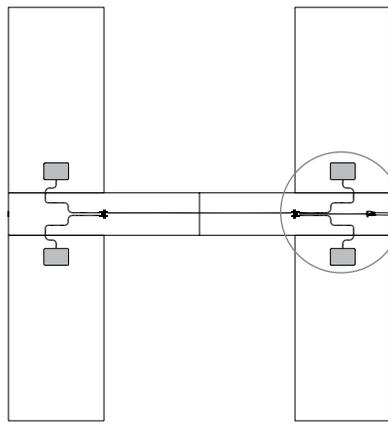

### Standard Application

- Half the width of the stage power is required at desk level only, two harnesses extend from the Four-way Splitter to connect to the Multi-Circuit Desk Power Module

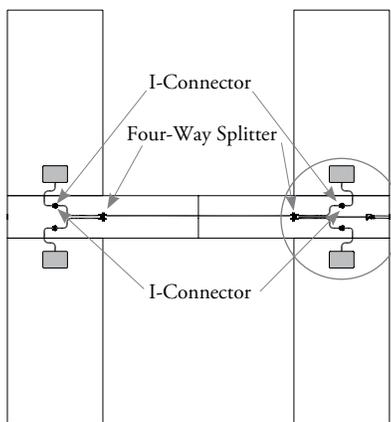
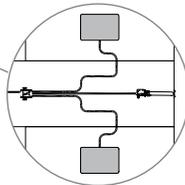

### Alternate Aesthetic Application

- When power is required at desk level only, two Harnesses extend from the Four-Way Splitter to two I-Connectors, (or an additional Four-Way Splitter) and a 24" Harness from each I-Connector to the Multi-Circuit Desk Power Module
- It is recommended that a 24" flexible harness be used to go from the stage to the bottom of the worksurface as it provides a better aesthetic

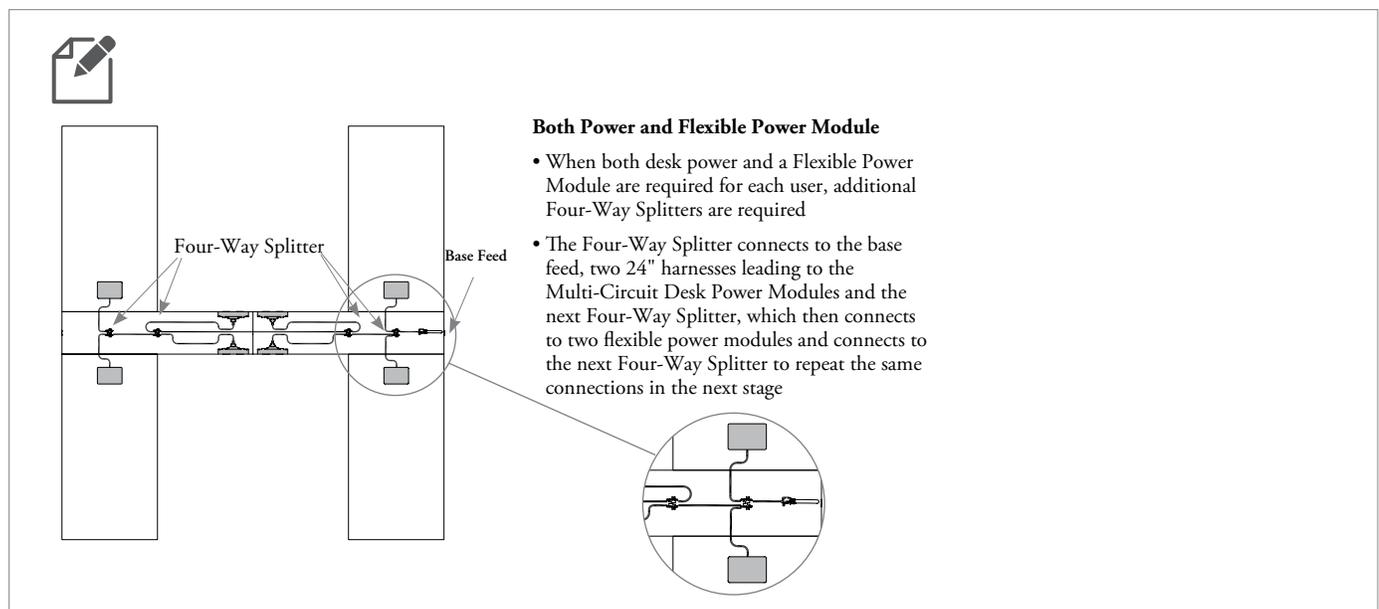
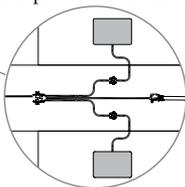

### Both Power and Flexible Power Module

- When both desk power and a Flexible Power Module are required for each user, additional Four-Way Splitters are required
- The Four-Way Splitter connects to the base feed, two 24" harnesses leading to the Multi-Circuit Desk Power Modules and the next Four-Way Splitter, which then connects to two flexible power modules and connects to the next Four-Way Splitter to repeat the same connections in the next stage

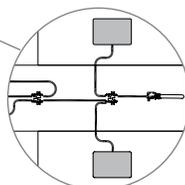

# planning with worksurface power access (continued)

## parallel worksurfaces

Rectangular Cut Out are available left, right and center.

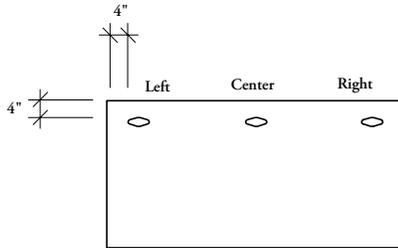

Rectangular Cut Out is inset 4" from the edge of the worksurface.

Access Door Cut Outs are available left, right and center.

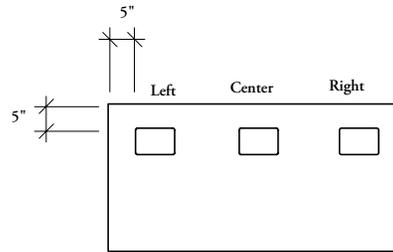

Access Door Cut Outs are inset 5" from the edge of the worksurface and can only be specified over the stage.

Access Door Cut Out can only be specified to be centered when planning with the Y-Leg in parallel applications.

Parallel and Perpendicular worksurfaces can be interchanged but electrical cut outs will not be in their correct positions. Also, the depths are not consistent so some gaps may appear.

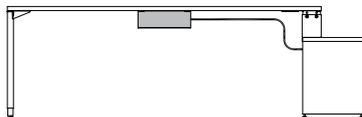
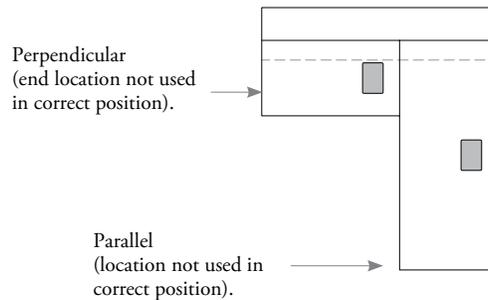
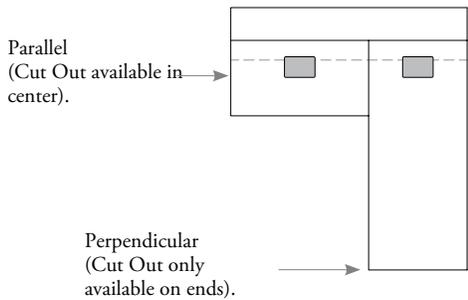

The Access Door for Multi-Circuit Desk can be specified centered on a parallel worksurface that has been mounted perpendicularly application, however the housing and cables will be visible. Longer harness will be required.

## wiring systems

Four wiring systems are available for Interpret 8-Wire Isolated (8T), 7-Wire Non Isolated (7T), 8-Wire Dual Isolated (8K) and 7-Wire Dual Non Isolated (7K). Most common Teknion wiring configurations are achieved with these wiring systems.

For sites where Isolated Ground is not available, Teknion offers Non-Isolated Ground options for furniture wiring. The site electrician or electrical contractor/consultant can identify sites where Isolated Ground is not available. For those sites, specify Teknion 7T or 7K wiring systems.

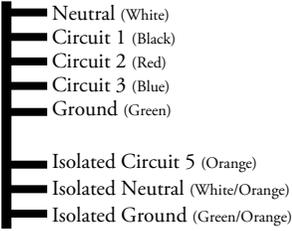
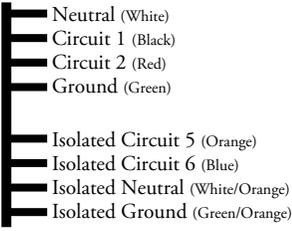
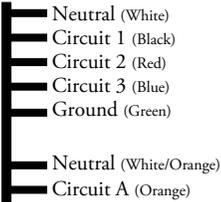
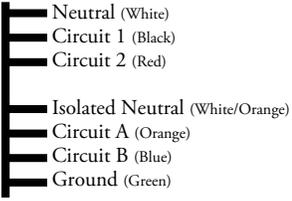
	No. Regular Circuits	No. Isolated Circuits
<b>8-Wire Isolated (8T) (3+1)</b> 	3	1
<b>8-Wire Dual Isolated (8K) (2+2)</b> 	2	2
<b>7-Wire Non Isolated (7T) (3+1)</b> 	4	0
<b>7-Wire Dual Non Isolated (7K) (2+2)</b> 	4	0

### wiring system/receptacles

	Wiring System			
	8T	8K	7T	7K
Regular Ground Receptacles	1, 2, 3	1, 2	1, 2, 3, A	1, 2, A, B
Isolated Ground Receptacles	5	5, 6	n/a	n/a

### wiring system/related circuit

	Wiring System			
	8T	8K	7T	7K
Regular Circuit 1 Receptacle	✓	✓	✓	✓
Regular Circuit 2 Receptacle	✓	✓	✓	✓
Regular Circuit 3 Receptacle	✓		✓	
Isolated Circuit 5 IG Receptacle	✓	✓		
Isolated Circuit 6 IG Receptacle		✓		
Regular Circuit A Receptacle			✓	✓
Regular Circuit B Receptacle				✓

✓ Applicable

#### 15 Amp

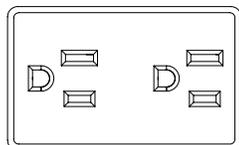

#### 20 Amp

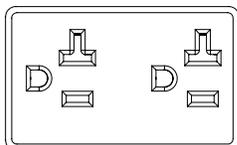

#### USB

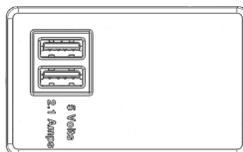

- Outlets are available 15, 20 amp or USB
- The 20 Amp is only available in Black
- USB is always on Circuit 1

# worksurface grain/pattern direction

Attention to grain/pattern direction is important when planning worksurfaces.

## grain direction

- There is no user edge so care must be taken during installation to match grain/pattern direction
- Grain/patterns are not “centered” on worksurfaces
- Applies to Foundation Laminate (Wood Grain patterns), Flintwood (Standard and Cathedral) and Natural Veneer

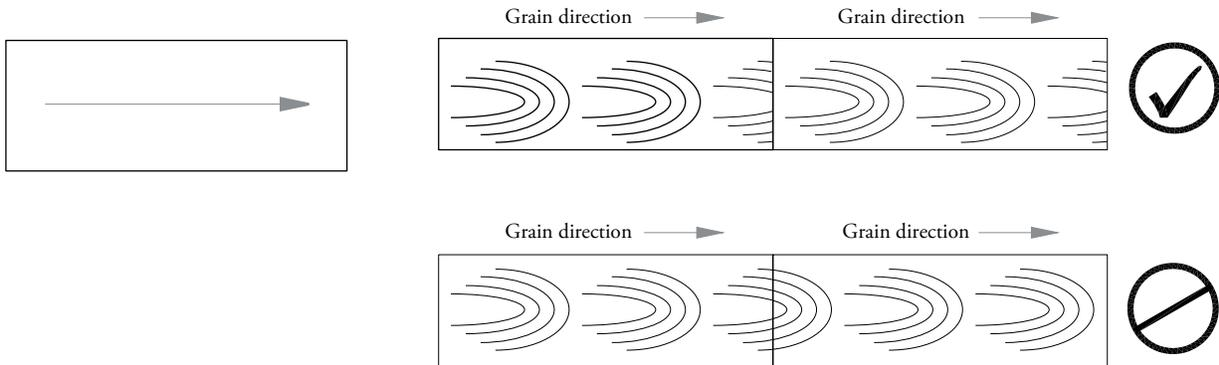

- Grain direction will appear in the same direction, from side to side
- For Cathedral Flintwoods and Natural Veneers the grain will run from left to right from the user's prospective

## edges

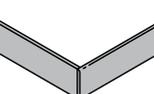
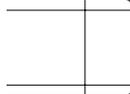
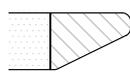
	Foundation Laminate Worksurface	Flintwood Worksurface	Natural Veneer Worksurface
<b>Flat (8)</b> All Edges 		n/a	n/a
<b>Flintwood Flat (9)</b> All Edges 	n/a		
<b>Flat (G)</b> All Edges 	n/a	n/a	n/a
<b>Full Knife (H)</b> User Edge 			
<b>Full Knife (X)</b> User Edge 	n/a	n/a	n/a

## worksurface supports & accessory basics

upStage supports worksurfaces and are used to mount to Stage or to make freestanding tables.

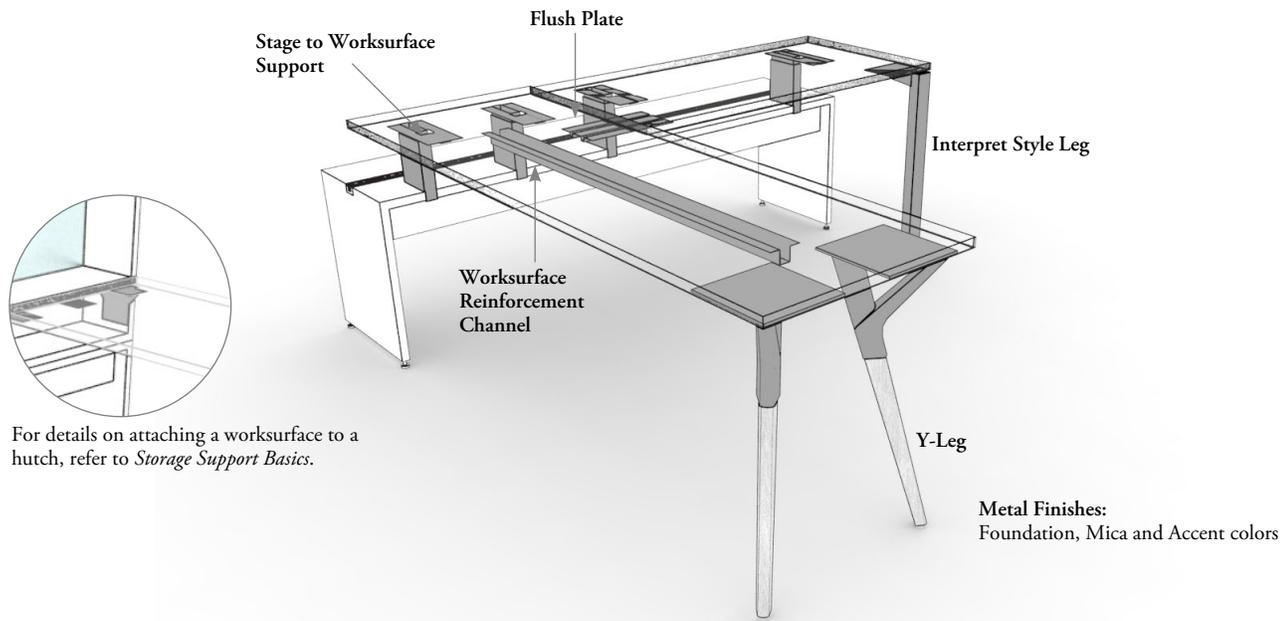

For details on attaching a worksurface to a hutch, refer to *Storage Support Basics*.

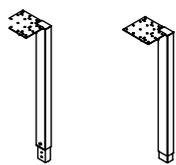

### Interpret Style Leg (HTWN)

- Used in freestanding and/or semi-suspended applications
- Available in pairs and singles (left and right), standard or height-adjustable
- Height-adjustable leg has range of 6" (3" above and 3" below)
- Standard leg has leveling range of 2" (1" above and 1" below)

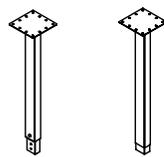

### Interpret Style Mono Leg (HTWM)

- Installed between two semi-supported worksurfaces to provide support
- Available fixed or height-adjustable
- Height-adjustable leg has range of 6" (3" above and 3" below)



### Y-Leg (HTWD)

- Y-Legs are available in two finish options
  - Wood & Metal (Upper support metal and lower support wood)
  - Metal & Metal (Upper and lower supports metal, can specify different metal finishes)
- Wood & Metal option offers an adjustment range of +1/2" and -1/2"
- Metal & Metal option offers an adjustment range of +2" and -1"
- Metal finishes: Foundation, Mica and Accent colors
- Wood support finishes: Flintwood and select Natural Veneer coordinate

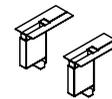

### Stage to Worksurface Support (HTWQ)

- Mounts to the underside of a worksurface and to the top of the stage to provide support to the worksurface
- Available fixed or height-adjustable
- Height-Adjustable ranges include +3" and -1"

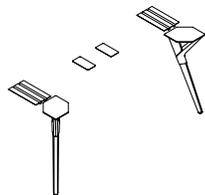

### End Worksurface Support Kit (HTWJ)

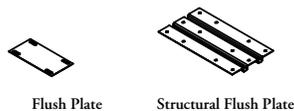

### Flush Plate (HTWA)

- Used in conjunction with other supports to maintain alignment of worksurfaces
- Available as Flush Plate or Structural Flush Plate
- Available in Black only



### Worksurface Support Wire Manager (HTWY)

- The HTWY cable router is used to guide power and data cables from the stage to the worksurface
- It is installed on top of the Stage to Worksurface Support (HTWQ) as an add-on piece

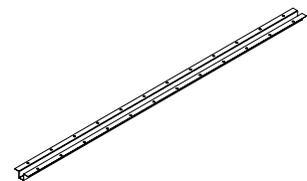

### Worksurface Reinforcement Channel (UNRC)

- Adds rigidity to worksurfaces to reduce deflection
- Must be used on all unsupported worksurface spans over 48"



# planning with worksurface supports

The following should be considered when planning with upStage worksurface Supports.

Worksurfaces must be supported on all corners, they cannot be cantilevered.

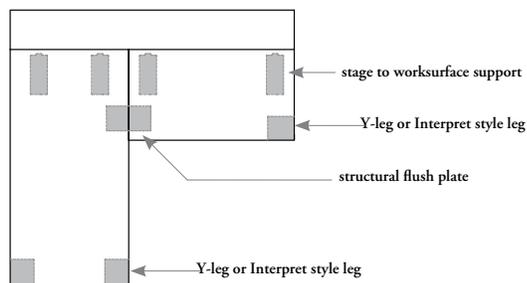

## flush plates

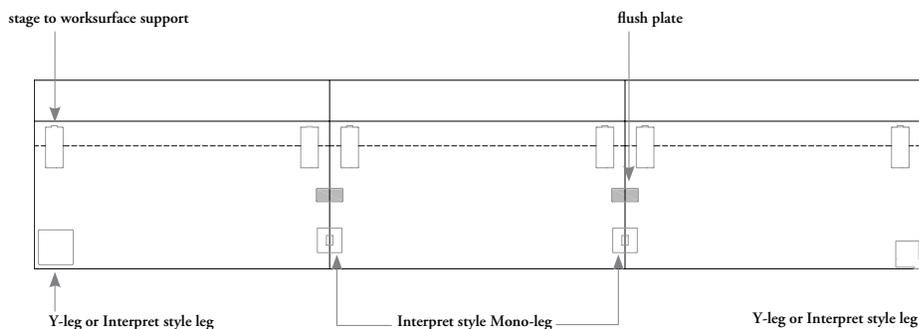
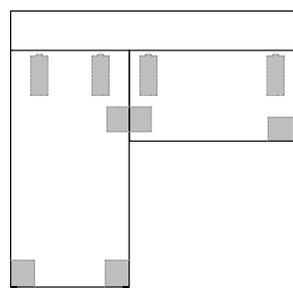

### Structural Flush Plate

Used with legs and brackets to provide required stability with worksurface returns.

### Flush Plate

Used in conjunction with other supports to maintain alignment of worksurfaces.

## stage to worksurface supports

Brackets mount to the underside of the stage to prevent damage when repositioning.

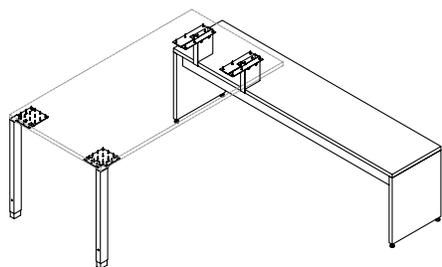

## worksurface support wire manager

Bracket can be installed right on top of the worksurface support (HTWQ) as an add-on piece.

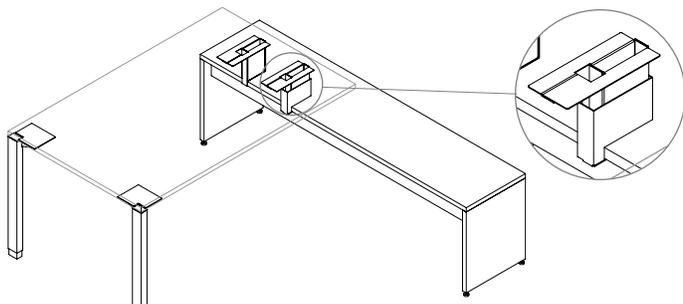

## planning with worksurface supports (continued)

### stage to worksurface supports (continued)

- Supports connect worksurfaces to Stages and can be installed anywhere along the length of the stage
- When no Access Door Cut Out, are required inset brackets 6" from the edge of worksurface

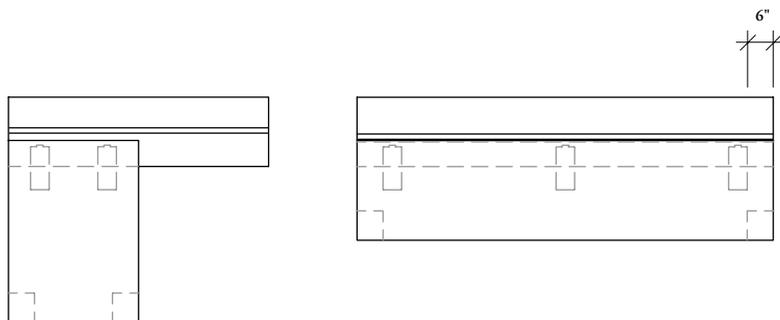

- Spacing from the edge of the worksurface is dependent on whether worksurface has Access Door Cut Out
- At least one Stage to Worksurface (HTWQ) support must be specified on each end of the worksurface and at least one every 72".
- Spacing location of the stage to worksurface Brackets are dependent on the location of the Multi-Circuit Module when specified

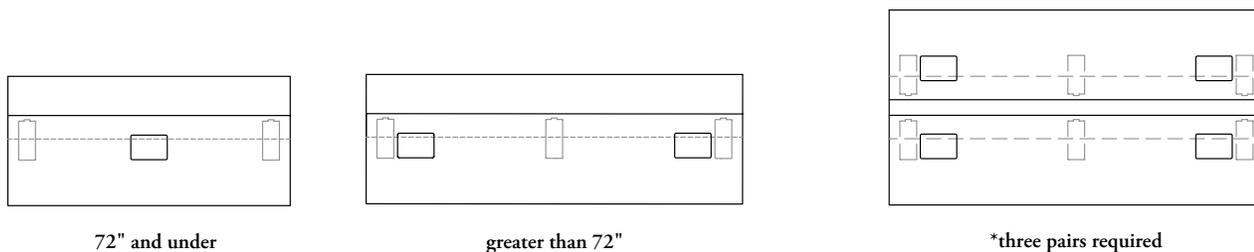

When the stage to Worksurface support is being planned in a perpendicular application with Access Door Cut Outs, the support locations are based on worksurface depths.

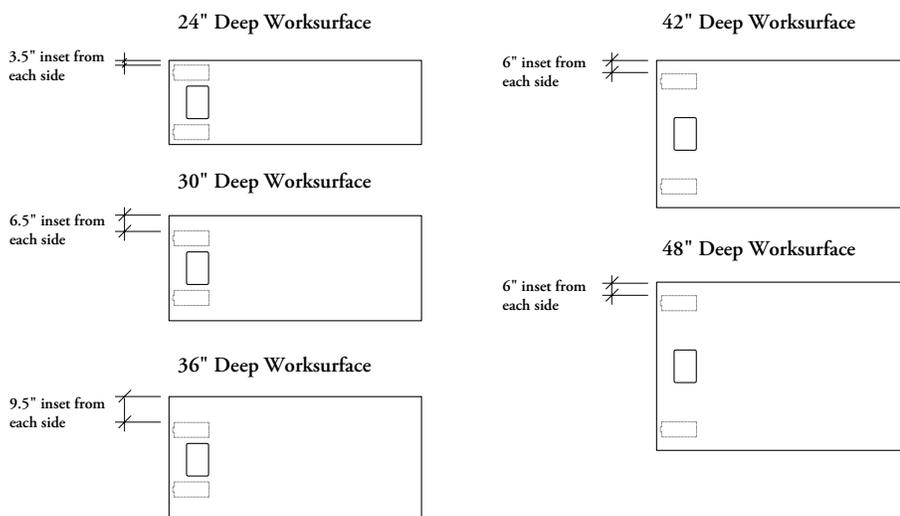

# planning with worksurface supports (continued)

## y-leg

In freestanding applications the Y-Leg enables worksurfaces to bridge over the stage to provide the necessary 2" gapping or it can be used to create freestanding tables.

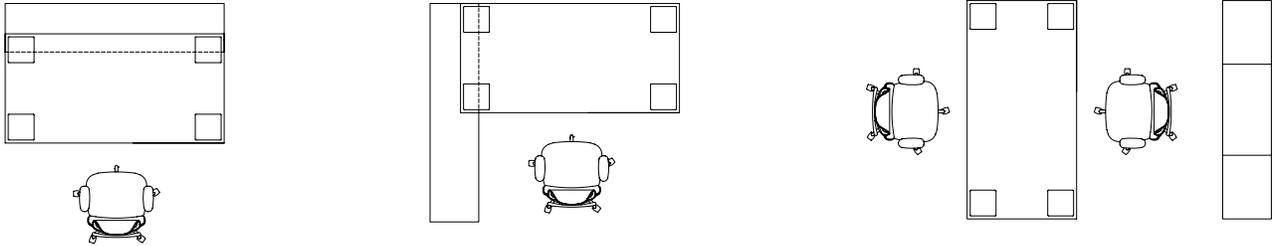

Parallel



Perpendicular

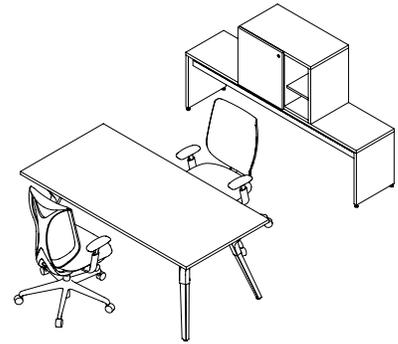

Freestanding

## edges

### Flat Edge

On worksurfaces with Flat Edges, the Interpret Post or Y-Legs is installed flush to the edge.

### Knife Edge

On worksurfaces with Knife Edges, the Interpret or Y-Legs are installed 1" inset from the edge.

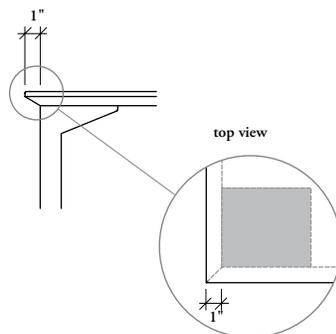
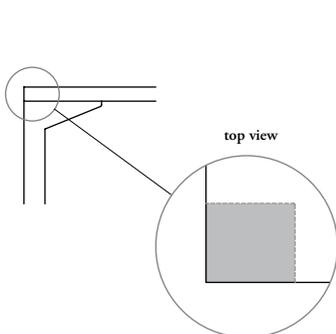

## planning with worksurface supports (continued)

### worksurface mounting

Y-Leg with wood finish and the Interpret Style Leg, fixed height leg **should not** be used when mounting a worksurface to a hutch stacker as it could cause leveling issues.

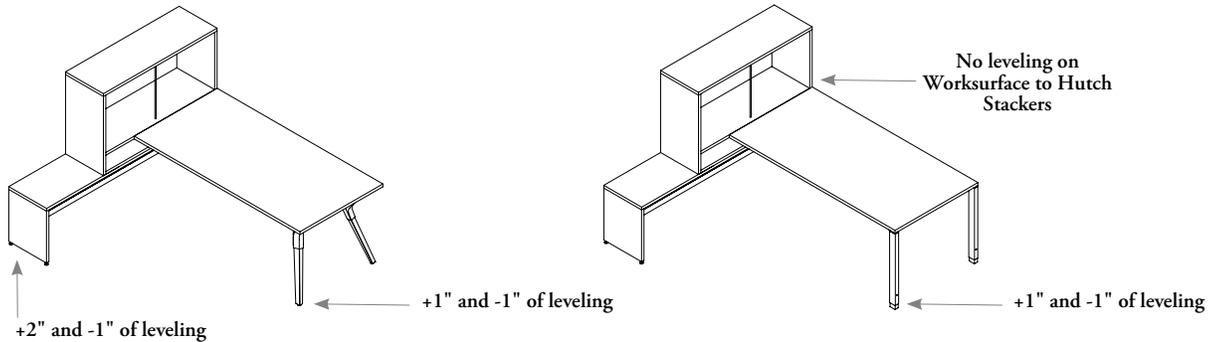

### Semi-Suspended

When planning with Y-Legs in a semi-suspended application, the metal finish should be specified as it allows for the height-adjustment range needed for leveling on uneven floors.

### interpret style post leg

Handedness is determined by the location of the leg from the users perspective.

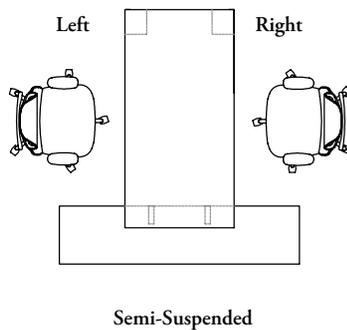
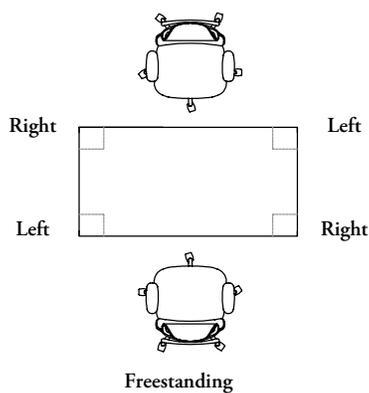

# planning with worksurface supports (continued)

## planning with end worksurfaces

End Worksurfaces are used to complete the ends of parallel planning applications. They function as shared collaborative surface on the end of runs and visually complete the end of the configuration.

End worksurfaces are offered in standard square corners (HTWG) or with a 3" radius (HTWZ).

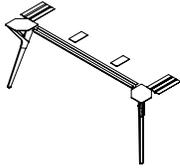

End Worksurface Support Kit (HTWJ)

+

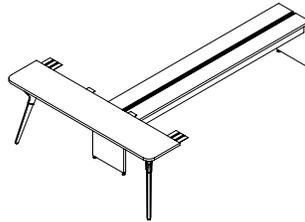

End Worksurface (HTWG)  
End with Radius Corners Worksurface (HTWZ)

=

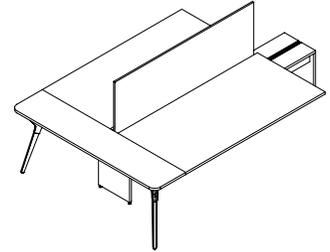

Complete Solution with End Worksurface

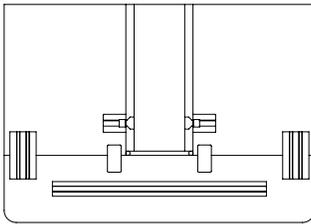

End Worksurface Support Kit (HTWJ) includes all required flush plates, reinforcement channels and an option of leg styles.

End Worksurfaces are sized to accommodate the 2" gap between the two parallel worksurfaces.

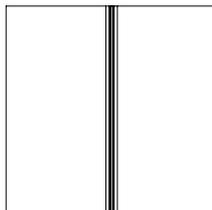
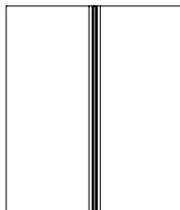
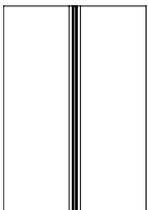

23" deep worksurfaces

29" deep worksurfaces

35" deep worksurfaces

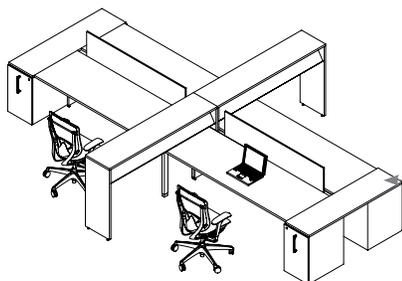

End Worksurface (HTWG)

The 16" deep End Worksurface can be used with 16" wide storage.

# planning with worksurface supports (continued)

## planning with dual perpendicular workspaces

The Dual Perpendicular Worksurface combines two workspaces, face to face, removing the cost of unnecessary middle legs. It also adds an accessory beam down the middle for the attachment of Interpret screens.

Dual Perpendicular Worksurfaces are offered with standard square corners or with a 2" radius.

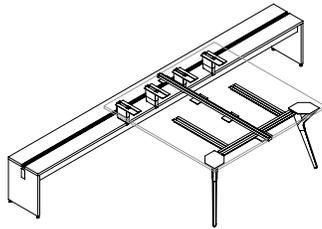

Stage to Dual Worksurface Support Kit (HTWB)

+

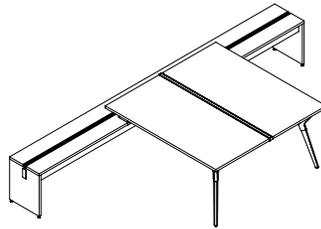

Dual Perpendicular Worksurface (HTWV)  
Dual Perpendicular with Radius Corner Worksurface (HTWW)

=

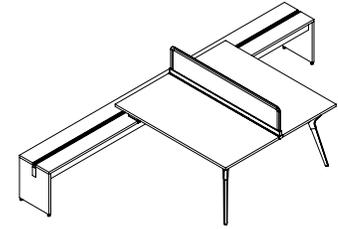

Complete solution with Dual Perpendicular Worksurface

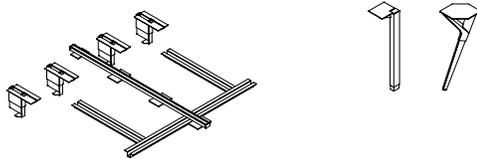

Stage to Dual Worksurface Support Kit (HTWB) includes all required flush plates, reinforcement channels and option of leg styles.

Two options are available for wire management:

- Grommet cut outs
- 1/2" wire gap between the worksurface and the accessory rail

If the wire gap option is not desired, the worksurface is available with no gap

A wire gap enables the mounting of desk edge accessories such as edge mounted power bars and monitor arms

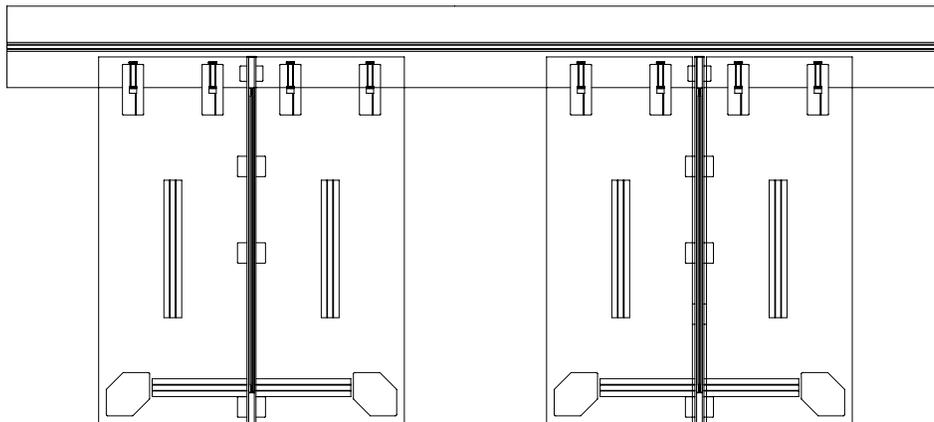

**Standard Dual worksurface with no Wire Gap**

- The worksurface will mount flush to the accessory beam
- Grommet cut-outs are recommended in this application

**Standard Dual worksurface with Wire Gap**

- The worksurface will have a 1/2" gap for wire management



height-adjustability



# height-adjustability

UNDERSTANDING HEIGHT-ADJUSTABLE TABLES . . . . .	82
UPSTAGE NAVIGATE HEIGHT-ADJUSTABLE TABLE BASICS . . . . .	84
UPSTAGE HISPACE HEIGHT-ADJUSTABLE TABLE BASICS . . . . .	86
PLANNING WITH UPSTAGE HEIGHT-ADJUSTABLE TABLES . . . . .	88
STAGE MODULE FOR HEIGHT-ADJUSTABLE TABLE BASICS . . . . .	93
PLANNING WITH STAGE MODULE FOR HEIGHT-ADJUSTABLE TABLES . . . . .	94
STAGE MODULE FOR HEIGHT-ADJUSTABLE TABLE POWER DISTRIBUTION BASICS . . . . .	97
PLANNING WITH STAGE MODULE FOR HEIGHT-ADJUSTABLE TABLE POWER ACCESS . . . . .	98
CREDENZA FOR HEIGHT-ADJUSTABLE TABLE BASICS . . . . .	100
PLANNING WITH CREDENZAS FOR HEIGHT-ADJUSTABLE TABLES . . . . .	101

## understanding height-adjustable tables

Height adjustable tables can be integrated into upStage in a variety of ways. The follow provides a step by step understanding of the options available.

### 1 Choose your application:

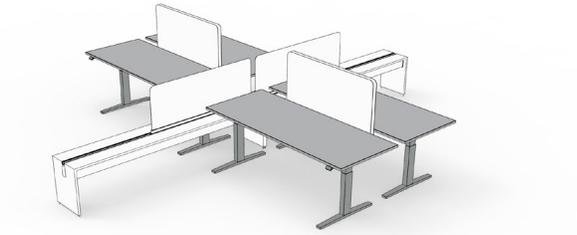

#### freestanding

- Both legs of height-adjustable table are exposed
- Allows for ease of reconfiguration

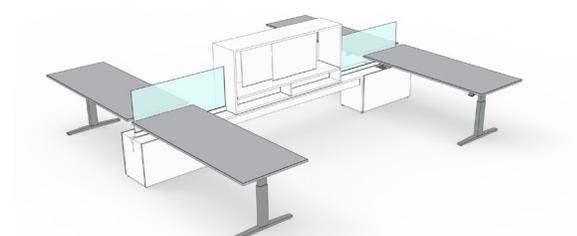

#### integrated with stage module

- One height-adjustable table leg is concealed in a stage module
- Ease of planning with smaller footprints

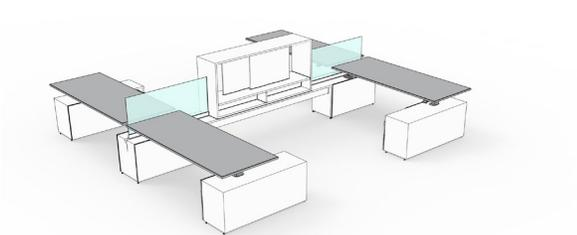

#### integrated with stage module and credenza

- One height-adjustable table leg is concealed in the stage module
- One height-adjustable table leg is concealed in a credenza
- Maximizes use of space with extra storage capabilities

# understanding height-adjustable tables (continued)

There are two options in upStage height-adjustable tables:

- Navigate
- hiSpace

## 2 Choose your height-adjustable table type:

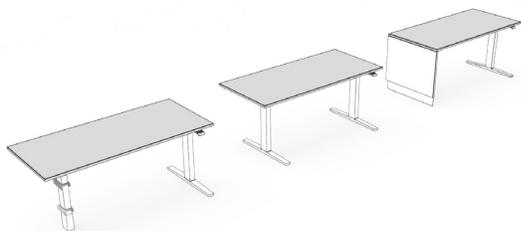

### navigate height-adjustable built-in tables

- Option of two types of base mechanisms:
  - Standard Range Electric
  - Extended-Electric-Restricted
- Leg styles:
  - Post Leg and T-Leg
  - T-Legs
  - T-Leg and Gable Leg
- Two worksurface styles:
  - Rectangular
  - Rectangular worksurface with Radius Corners
- Worksurface finishes:
  - Foundation Laminate, Flintwood and Natural Veneer
- Power and undersurface cable management options available



### hiSpace height-adjustable built-in quickconnect tables

- Option of one type of base mechanism:
  - Extended Electric with Riser
- Leg styles:
  - T-Legs
- Two worksurface styles:
  - Rectangular
  - Rectangular worksurface with Radius Corners
- Worksurface finishes:
  - Foundation Laminate
- Power and undersurface cable management options available

## upstage navigate height-adjustable table basics

upStage Navigate tables are available with a square or radius corner profile.

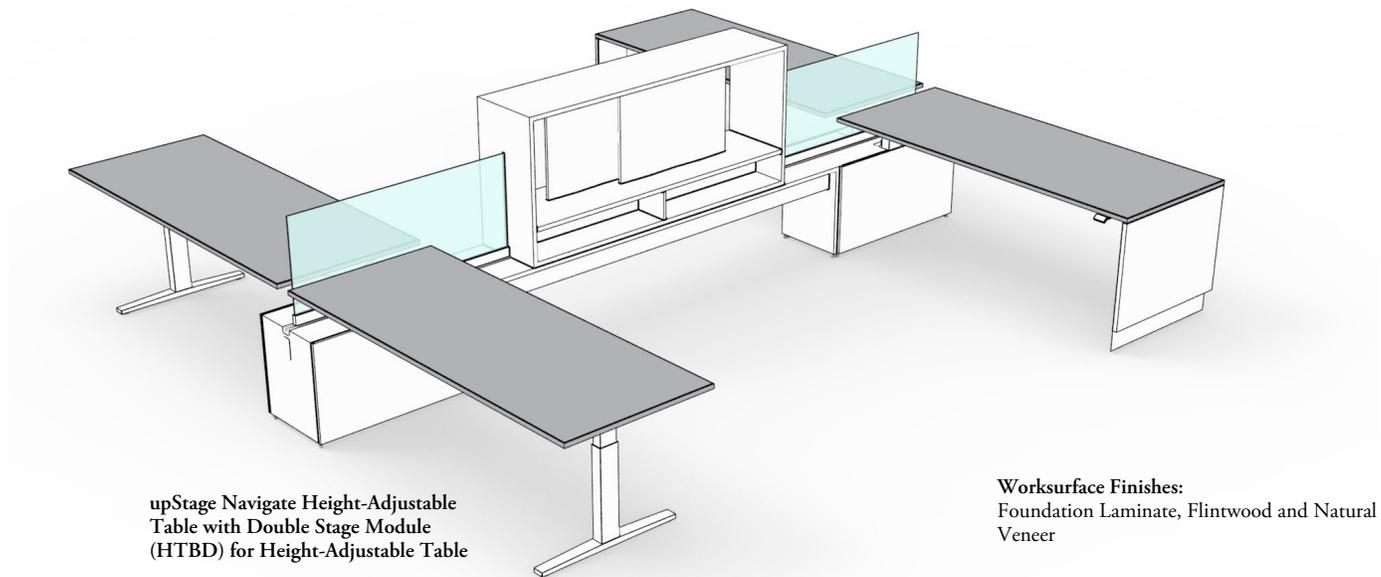

upStage Navigate Height-Adjustable Table with Double Stage Module (HTBD) for Height-Adjustable Table

**Worksurface Finishes:**  
Foundation Laminate, Flintwood and Natural Veneer

Navigate worksurfaces are used with a coordinating Navigate height-adjustable base to create a complete table.

- Widths: 53", 59", 65", 71", 77" and 83" (actual)
- Depths: 25" and 30" (actual)
- Cut Out Styles:
  - None (no cut outs)
  - Rectangular (Diamond Shaped cut outs)

For more information about planning with IEC connection and height-adjustability, refer to Complements: *Teknion's Ergonomics & Accessories Program*.

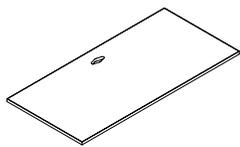

### Rectangular Height-Adjustable Worksurface (WBU)

- A height-adjustable worksurface with a rectangular corner profile
- Available in three different leg applications:

#### Two T-Leg

- Two T-Leg (Left Leg in Corridor, Right Leg in Stage Module) (TML)
- Two T-Leg (Right Leg in Corridor, Left Leg in Stage Module) (TMR)
- Two T-Leg (Left Leg in Credenza, Right Leg in Stage Module) (TCL)
- Two T-Leg (Right Leg in Credenza, Left Leg in Stage Module) (TCR)

#### T-Leg and Post Leg

- T-Leg and Post Leg (Left Post in Credenza, Right Leg in Stage Module) (PTL)
- T-Leg and Post Leg (Right Post in Credenza, Left Leg in Stage Module) (PTR)

#### Gable and T-Leg

- Gable and T-Leg (Left Gable in Corridor, Right Leg in Stage Module) (GTL)
- Gable and T-Leg (Right Gable in Corridor, Left Leg in Stage Module) (GTR)



### Rectangular Height-Adjustable Worksurface with Radius Corners (WJU)

- A height-adjustable worksurface that have radius corner profile
- Available in two different leg applications:

#### Two T-Leg

- Two T-Leg (Left Leg in Corridor, Right Leg in Stage Module) (TML)
- Two T-Leg (Right Leg in Corridor, Left Leg in Stage Module) (TMR)
- Two T-Leg (Left Leg in Credenza, Right Leg in Stage Module) (TCL)
- Two T-Leg (Right Leg in Credenza, Left Leg in Stage Module) (TCR)

#### T-Leg and Post Leg

- T-Leg and Post Leg (Left Post in Credenza, Right Leg in Stage Module) (TTL)
- T-Leg and Post Leg (Right Post in Credenza, Left Leg in Stage Module) (TTR)

# upstage navigate height-adjustable table basics (continued)

upStage Navigate tables are available with a square or radius corner profile.

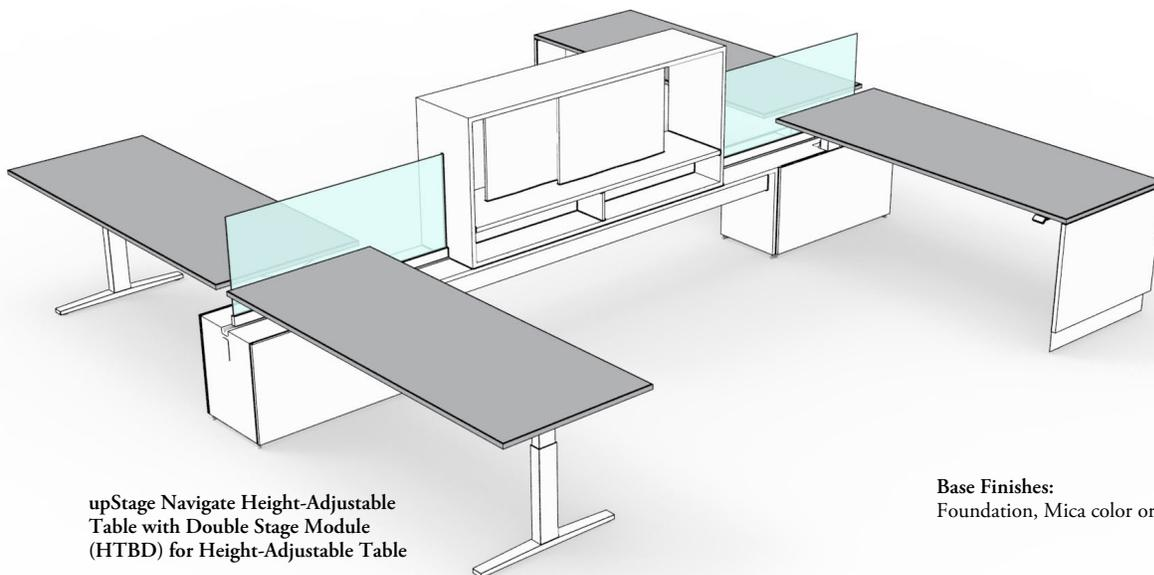

**upStage Navigate Height-Adjustable Table with Double Stage Module (HTBD) for Height-Adjustable Table**

**Base Finishes:**  
Foundation, Mica color or Accent

Navigate bases are used with a corresponding Navigate height-adjustable worksurface to create a complete table.

**Base Mechanisms:**

- Standard Range Electric (27" to 43")
- Extended Range Electric-Restrict Height (25" to 48.7")

**Switch Styles:**

- Standard Up/Down
- Display with Up/Down Memory
- Toggle Up/Down
- Display Toggle with Memory and Navigate GPS

**Optional Under Surface Cable Manager**

- Cable Organizer with or without felt cover
- Dual Plastic Tray with or without Power Bar

**Optional Vertical Wire Carrier**

- Optional Cross Chanel Integrated Powerbar

For more information about planning with IEC connection and height-adjustability, refer to Complements: *Teknion's Ergonomics & Accessories Program*. Bases are handed, the handedness is determined by the location of the corridor, stage module, or credenza.

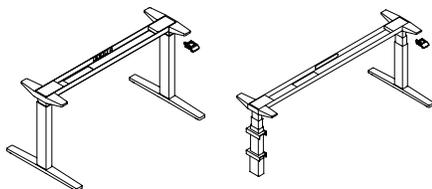

**upStage Height-Adjustable Built-In Base (YGU)**

- The Built-in Table Base size is determined by the size of the worksurface it is used with
- Widths: 53", 59", 65", 71", 77", 83" (actual)
- Depths: 25" and 30" (actual)
- Leg style:
  - Standard T-Leg (30" deep)
  - Standard T-Leg and Post Leg
- Available for following Leg Applications:
  - Two T-Leg (Left Leg in Corridor, Right Leg in Stage Module)
  - Two T-Leg (Right Leg in Corridor, Left Leg in Stage Module)
  - Two T-Leg (Left Leg in Credenza, Right Leg in Stage Module)
  - Two T-Leg (Right Leg in Credenza, Left Leg in Stage Module)
  - T-Leg and Post Leg (Left Post in Credenza, Right Leg in Stage Module)
  - T-Leg and Post Leg (Right Post in Credenza, Left Leg in Stage Module)

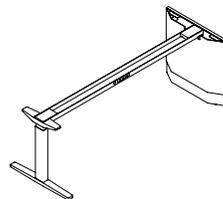

**upStage Height-Adjustable Built-In Gable Base (YVU)**

- The Built-in Base size is determined by the size of the worksurface it is used with
- Widths: 47", 53", 59", 65", 71" 77", 83" (actual)
- Depths: 30" (actual)
- Available for following Leg Applications:
  - Gable and T-Leg (Left Gable in the Corridor, Right Leg in the Stage Module)
  - Gable and T-Leg (Right Gable in the Corridor, Left Leg in the Stage Module)

# upstage hispace height-adjustable table basics

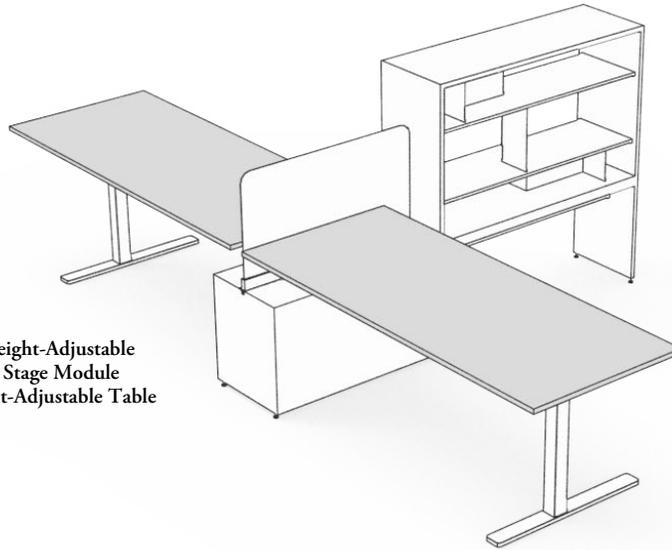

upStage hiSpace Height-Adjustable Table with Double Stage Module (HTBD) for Height-Adjustable Table

**Worksurface Finishes:**  
- Foundation Laminate

hiSpace worksurfaces are used with a coordinating hiSpace height-adjustable base to create a complete table.

- Widths: 53", 59", 65", and 71" (actual)
- Depths: 25" and 30" (actual)
- Cut Out Styles
  - None (no cut outs)
  - Rectangular (Diamond Shaped cut outs)
- Cut Out Styles:
  - None (no cut outs)
  - Center
  - Left
  - Right

For more information about planning with IEC connection and height-adjustability, refer to Complements: *Teknion's Ergonomics & Accessories Program*.

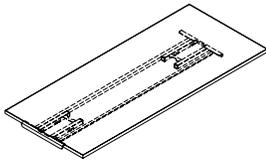

### Rectangular Height-Adjustable Worksurface (WBA)

- A height-adjustable worksurface with a rectangular corner profile
- Available in four different T-leg applications:
  - Two T-Leg (Left Leg in Corridor, Right Leg in Stage Module) (TML)
- Two T-Leg (Right Leg in Corridor, Left Leg in Stage Module) (TMR)
  - Two T-Leg (Left Leg in Credenza, Right Leg in Stage Module) (TCL)
  - Two T-Leg (Right Leg in Credenza, Left Leg in Stage Module) (TCR)

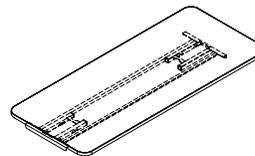

### Rectangular Height-Adjustable Worksurface with Radius Corners (WJB)

- A height-adjustable worksurface that have radius corner profile
- Available in four different T-leg applications:
  - Two T-Leg (Left Leg in Corridor, Right Leg in Stage Module) (TML)
- Two T-Leg (Right Leg in Corridor, Left Leg in Stage Module) (TMR)
  - Two T-Leg (Left Leg in Credenza, Right Leg in Stage Module) (TCL)
  - Two T-Leg (Right Leg in Credenza, Left Leg in Stage Module) (TCR)

# upstage hispace height-adjustable table basics (continued)

upStage hiSpace Height-Adjustable Table with Double Stage Module (HTBD) for Height-Adjustable Table

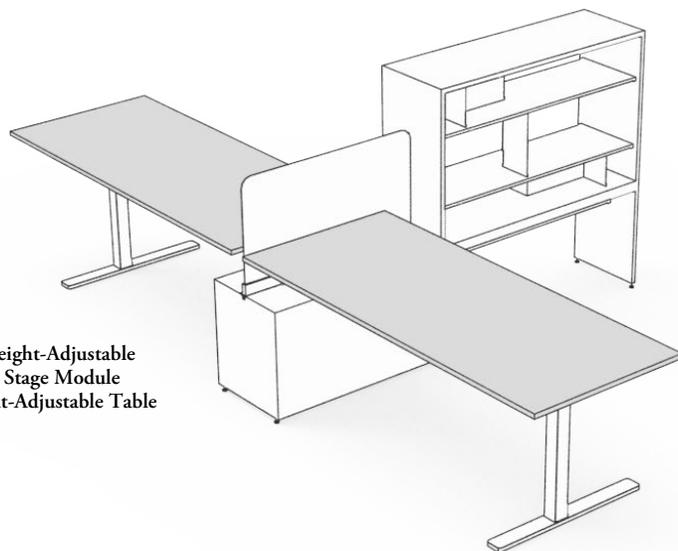

**Base Finishes:**  
 - Platinum  
 - Very White  
 - Ebony

hiSpace bases are used with a corresponding hiSpace height-adjustable worksurface to create a complete table.

Base Mechanisms:

- Extended Electric with Riser (25" to 51.1")
- Display with Up/Down Memory

Optional Undersurface Cable Management:

- Cable Organizer with Felt Cover
- None
- Optional Cross Chanel Integrated Powerbar

For more information about planning with IEC connection and height-adjustability, refer to Complements: *Teknion's Ergonomics & Accessories Program*. Bases are handed, the handedness is determined by the location of the corridor, stage module, or credenza.

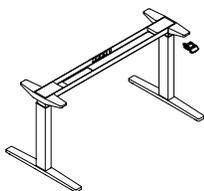

## upStage Height-Adjustable Built-In Base (YGU)

- The Built-in Table Base size is determined by the size of the worksurface it is used with
- Widths: 53", 59", 65", and 71" (actual)
- Depths: 25" and 30" (actual)
- Leg style: Standard T-Leg
- Available for following Leg Applications:
  - Two T-Leg (Left Leg in Corridor, Right Leg in Stage Module (TML)
  - Two T-Leg (Right Leg in Corridor, Left Leg in Stage Module (TMR)
  - Two T-Leg (Left Leg in Credenza, Right Leg in Stage Module (TCL)
  - Two T-Leg (Right Leg in Credenza, Left Leg in Stage Module (TCR)

## planning with upstage height-adjustable tables

The following should be considered when planning with upStage Navigate and hiSpace Height-Adjustable tables.

### cut outs and grommets

Grommets are used to direct wires to the underside of the desk so they can be plugged into an under worksurface power bar or directed to the Vertical Wire Carrier (YEEE) for plugging into a monument or power bar that is not on the desk.

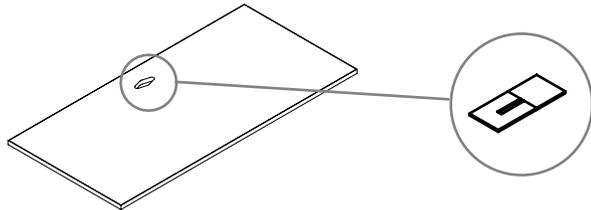

Cut out locations:

- None
- Rectangular Center
- Rectangular Right
- Rectangular Left

Rectangle Grommet (HTEG) routes power through the worksurface to the Flexible Power Module specified on the stage and is ordered separately.

### grommet options

Left, right and center cut out positions are available. Cut outs **cannot** be specified in the corridor side if credenzas are specified, to avoid wires or components interference. The following are cut out locations:

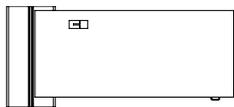

Rectangular Left Cut Out Location

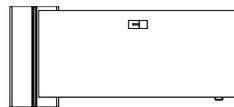

Rectangular Center Cut Out Location



Rectangular Right Cut Out Location

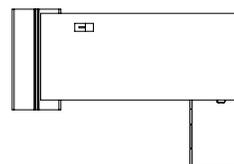

Rectangular Left Cut Out Location

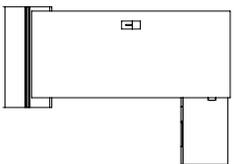

Rectangular Center Cut Out Location

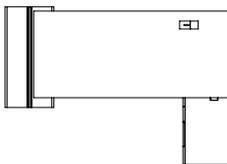

Rectangular Right Cut Out Location





# planning with upstage height-adjustable tables (continued)

## height-adjustment range

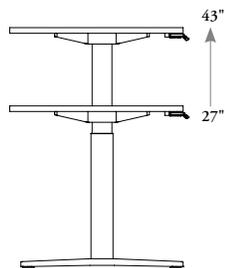

### Standard Electric

- Minimum Height: 27"
- Maximum Height: 43"

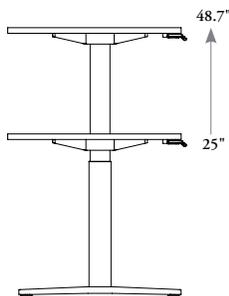

### Extended Electric - Restricted

- Minimum Height: 25"
- Maximum Height: 48.7"
- Minimum height is restricted so it does not interfere with a credenza or stage module

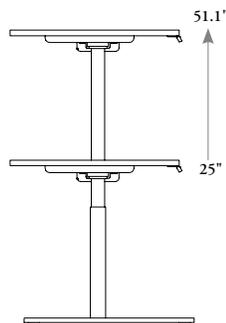

### hiSpace Extended Electric - Riser

- Minimum Height: 25"
- Maximum Height: 51.1"

## upstage height-adjustable table leg integration

upStage Height Adjustable tables must always have one leg integrated into a stage module with the other leg integrated into the credenza or on the corridor. There are four options for upstage height-adjustable leg integration:

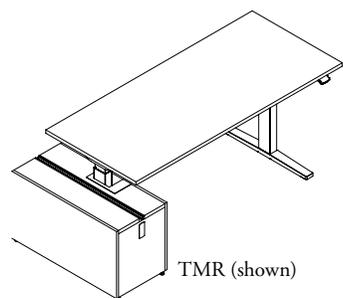

### T-Leg and Corridor (TMR/TML)

- Two T-Legs
- One Leg is integrated into the stage module and the other leg exposed
- Accommodates worksurface depths of 25" and 30"

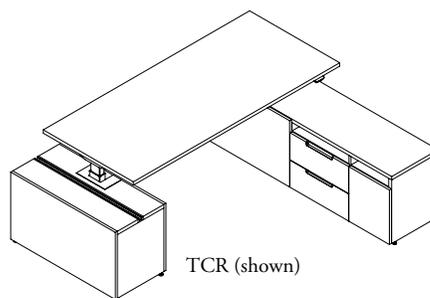

### T-Leg and Credenza (TCR/TCL)

- Two T-Legs
- One Leg is integrated into the stage module and the other leg is integrated into one of the following credenzas:
  - Double Credenza for HA Table (HTSCC)
  - Triple Credenza for HA Table (HTSCT)
- Accommodates worksurface depths of 30" only

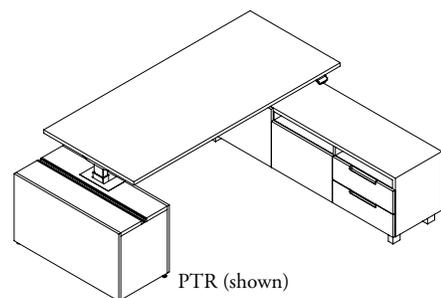

### Post and T-Leg (PTR/PTL)

- One T-Leg and one Post Leg
- The T-Leg is integrated into the stage module and the Post leg is integrated into one of the following Elevated Credenzas:
  - Height-Adjustable Integrated Double Credenza (HTSCD) or,
  - Height-Adjustable Integrated Triple Credenza (HTSCP)
- Accommodates worksurface depths of 30" only

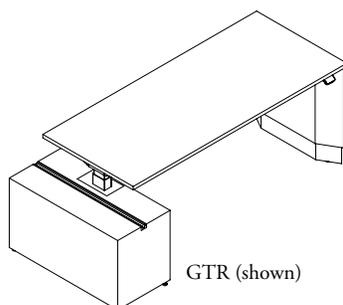

### Gable and T-Leg (GTR/GTL)

- This application is only available on Navigate Height-adjustable built-in tables
- One Gable and one T-Leg
- The T-Leg is integrated into the stage module and the gable is exposed on the corridor side
- Accommodates worksurface depths of 30" only

## planning with upstage height-adjustable tables (continued)

### handedness

upstage Height-Adjustable worksurfaces are specified right or left handed. Handedness is determined by the user's point of view, sitting at the desk. The worksurface has an overhang which is always on the corridor side and determines the handedness of the worksurface.

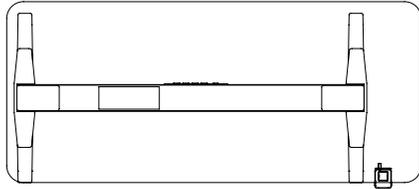

Right handed worksurface, overhang to the corridor side on right

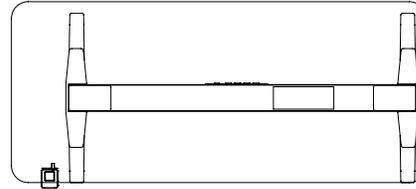

Left handed worksurface, overhang to the corridor side on left

To plan a right handed layout; Worksurface, Base, Stage Module, Credenza and Screens - all have to be specified right handed.

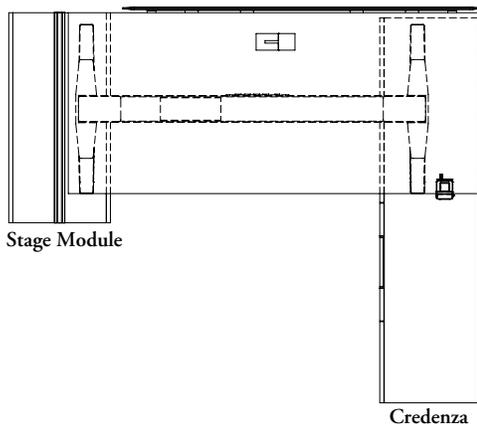

### right handed workstation layout

#### Right handed

- upStage Height-Adjustable Table - Right Handed
- Single Stage Module for Height-Adjustable Table - Right Handed
- upStage Credenza for Height-Adjustable Table - Right Handed

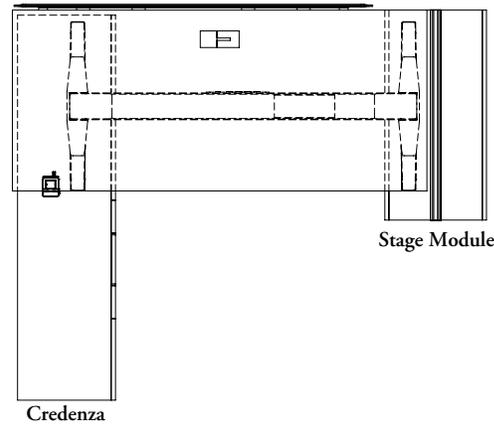

### left handed workstation layout

#### Left handed

- upStage Height-Adjustable Table - Left Handed
- Stage Module for Height-Adjustable Table - Left Handed
- upStage Credenza for Height-Adjustable Table - Left Handed

# planning with upstage height-adjustable tables (continued)

## switches

There are four switches available when specifying the upStage Navigate Height-Adjustable Built-In Base.

- Navigate
  - Standard Up/Down
  - Display with Up/Down Memory
  - Toggle Up/Down
  - Display Toggle w/ Memory & Navigate GPS
- hiSpace
  - Display with Up/Down Memory
  - Toggle with Display Memory

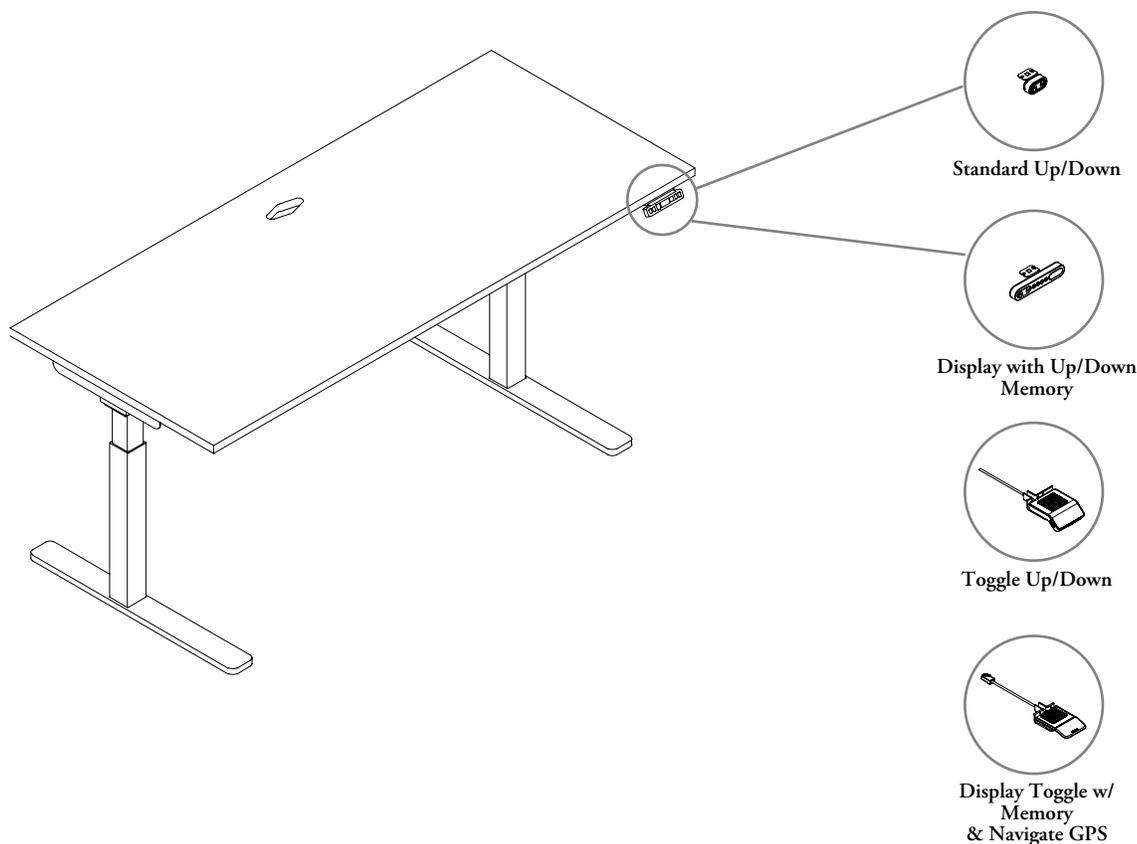

## wire management

### power bars

There is an optional Cross Channel Integrated Power Bar which is mounted under the worksurface in the cross channel.

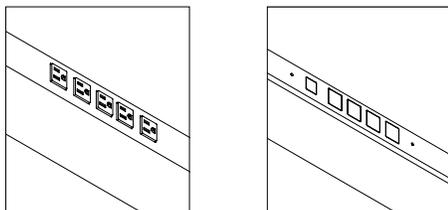

- Available on worksurfaces with 53" - 83" widths
  - Includes four outlets and one internal cord to provide power both the table controls and the power bar
- If no Cross Channel Integrated Power Bar is specified, a cover plate will be provided.

### power pack on hiSpace

There is an optional power pack integrated with Cable Organizer with felt cover.

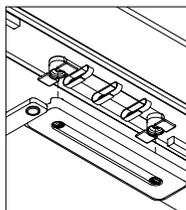

- Available on worksurfaces 53" - 71"

## planning with upstage height-adjustable tables (continued)

### under surface cable manager

The following under surface are available for upStage Navigate and hiSpace Height-Adjustable Built-In bases:

- Navigate
  - None
  - Cable organization with felt cover (Only available on worksurface depths 30')
  - Cable organization with no cover
  - Dual Plastic Trays & Power Bar
  - Dual Plastic Trays
- hiSpace
  - None
  - Dual Plastic Trays & Power Bar
  - Dual Plastic Trays

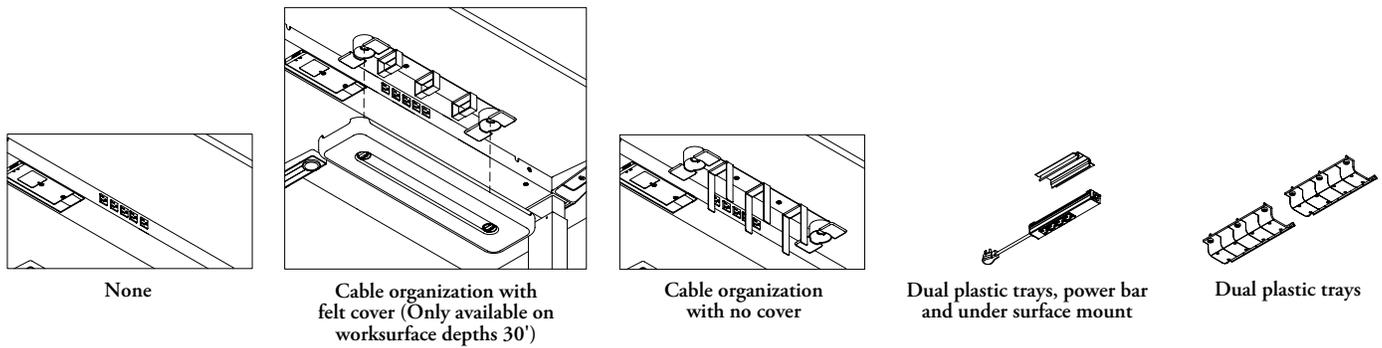

### vertical wire carrier

Vertical Wire Carriers are an option on upStage Navigate and hiSpace Height-Adjustable Built-In Bases:

- None
- Vertical Wire Carrier

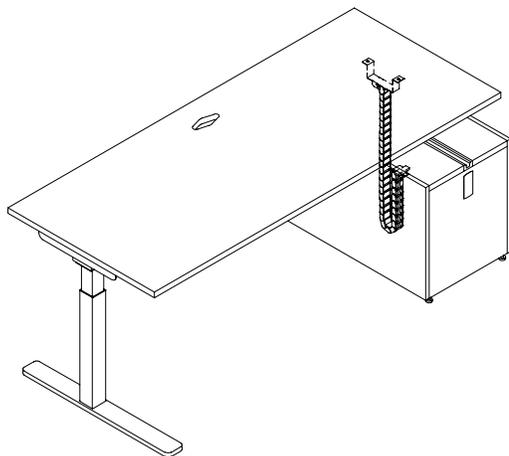

# stage module for height-adjustable table basics

The Stage Module for Height-Adjustable Table provides built-in single- or double-sided height-adjustable tables.

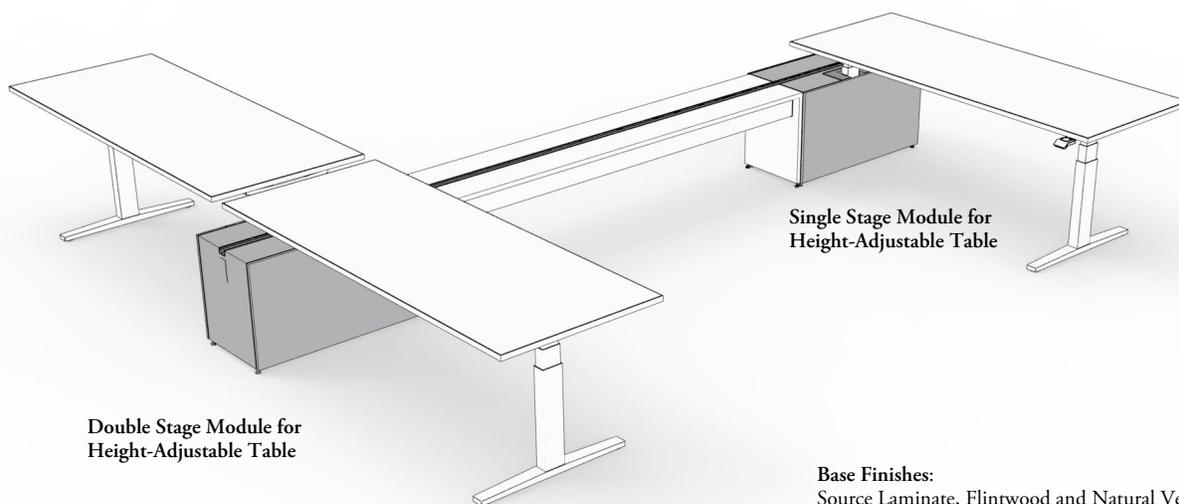

Double Stage Module for Height-Adjustable Table

Single Stage Module for Height-Adjustable Table

**Base Finishes:**  
Source Laminate, Flintwood and Natural Veneer  
**Front Finishes:**  
Source Laminate, Flintwood and Natural Veneer  
**Metal Finishes:**  
Foundation, Mica and Accent colors

- Connects to any Beginning, End or Complete Stage for integration of Height-Adjustable Tables
- An integrated option is available on Navigate tables that allows the leg to be concealed into the Stage Module
- Widths: 30", 36" and 42"
- Height: 21"
- Depth: 16"
- Available with an optional Accessory Beam to maintain a continuous look and functionality with other Stages
- Available with Infeed Grommet options. Options:
  - One Grommet
  - Two Grommets
  - No Grommets
- Stage connectors are provided with Stage Modules in order to connect them to the End Gables on the Stage.

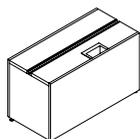

Single Stage Module for Height-Adjustable Table (HTBH)

- Used when a Height-Adjustable Table is used on one side only
- Handedness is determined by the location of the table

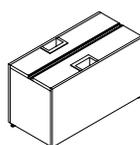

Double Stage Module for Height-Adjustable Table (HTBD)

- Used when a Height-Adjustable Table is used on both sides of the Module
- Is not handed

## planning with stage module for height-adjustable tables

The following should be considered when planning with Stage Modules for Height-Adjustable tables.

### handedness

Handedness, when applicable, is determined by the worksurface overhang which will always be on the corridor side

Single stage modules for Height-Adjustable Tables are handed, The handedness is determined by the location of the cut out on the module from the users perspective

Single-sided modules must be specified left or right and cannot be rotated

#### Right handed

- upStage Height-Adjustable Navigate Table - Right Handed
- Single Stage Module for Height-Adjustable Table - Right Handed
- upStage Credenza for Height-Adjustable Table - Right Handed

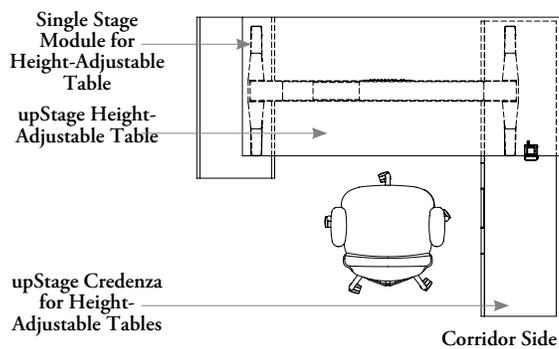

#### Left handed

- upStage Height-Adjustable Navigate Table - Left Handed
- Stage Module for Height-Adjustable Table - Left Handed
- upStage Credenza for Height-Adjustable Table - Left Handed

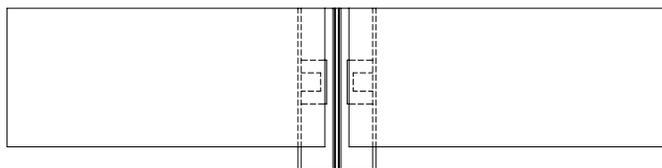
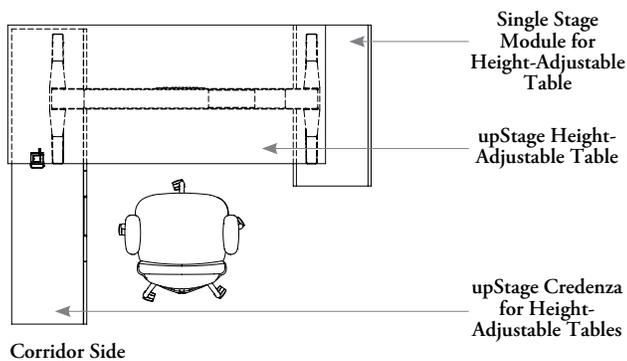

Double-sided stage modules for Height-Adjustable Tables are non-handed

Since the product is shipped unassembled, handedness is determined during assembly for double-sided modules

# planning with stage module for height-adjustable tables (continued)

## leg grommet

The movable leg grommet accommodates multiple positions of the upStage Navigate or hiSpace height-adjustable table leg within the module based on screen type and planning application.

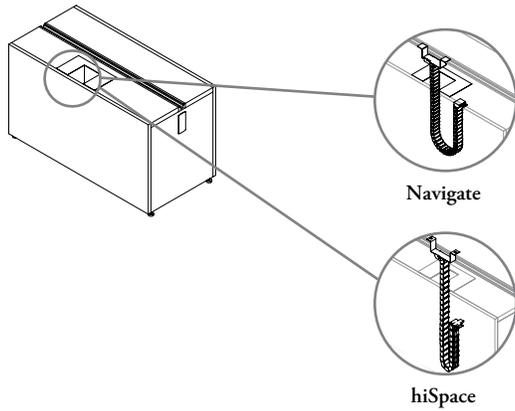

When planning back-to-back with height-adjustable tables and credenza, the leg cut out allows screens to be added in the future without disassembling the whole layout.

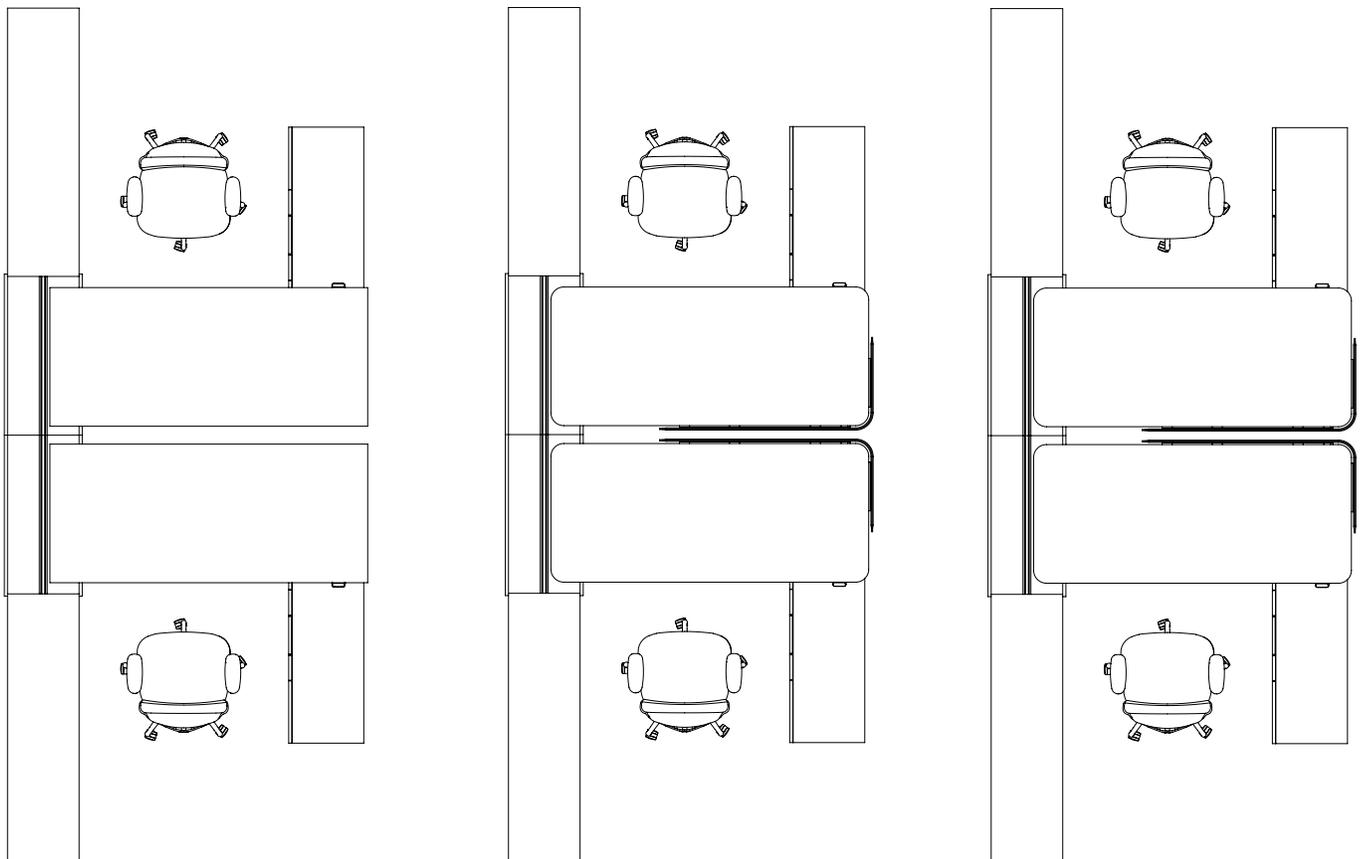

## planning with stage module for height-adjustable tables (continued)

### stage modules with leg integration and vertical wire carrier

The Stage Module for Height-Adjustable Table is complete with an offset cut out for the upStage height adjustable table leg to be recessed into the module. When the unit is closed, the leg and Vertical Wire Carrier will be concealed.

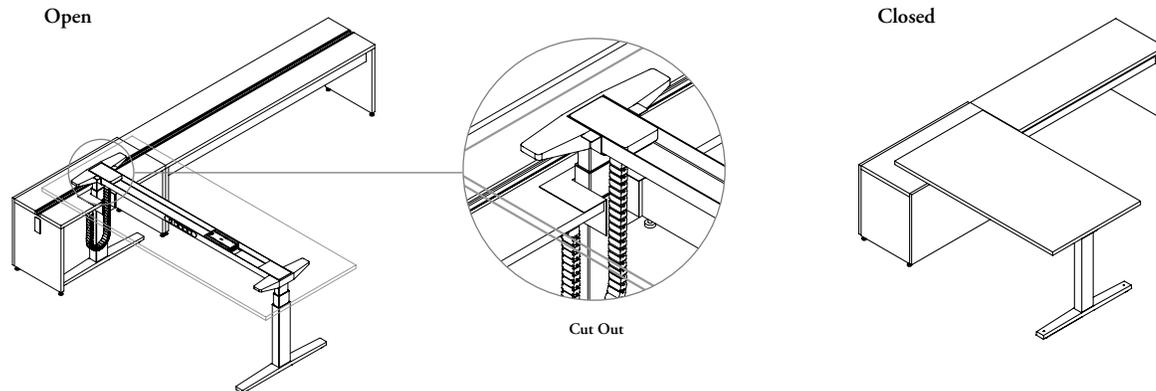

### stage modules with wire management

The above worksurface power for monitors, lights etc. should be routed through a cut out with Grommet (HTEG) and plugged into an under worksurface Power Bar (see Complements: *Teknion's Ergonomics & Accessories Program*). It is routed through a cable tray and then to the Vertical Wire Carrier Vertical Cable Manager, Navigate for upStage Built-In Stage (YEEE11) to the interior of the module, so that no cables are visible.

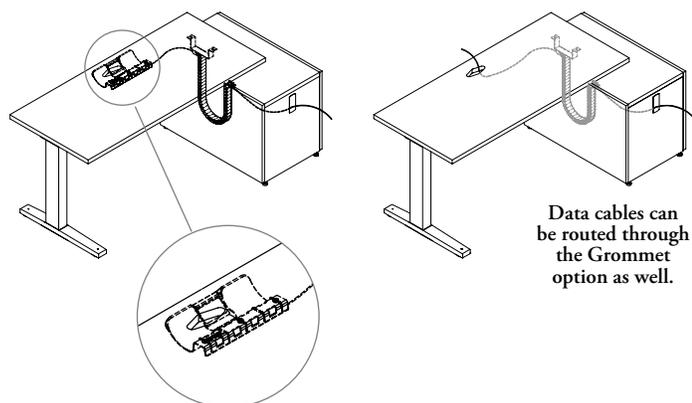

### connecting stage modules for height-adjustable tables to stage modules with stage connectors

- The Stage Module for Height-Adjustable Table connects to the End Gables on the stage using the Stage Connector that is included. It cannot be mounted to a Mid Gable
- The Infeed Grommet option allows electrics to pass through to the stage. The Infeed Grommet option must be selected on the adjacent Stage if power routing is required through to the Module
- When one Infeed Grommet is specified, Stage module will include one Stage Connector. When two, Infeed Grommets are specified, it will include two Stage Connectors

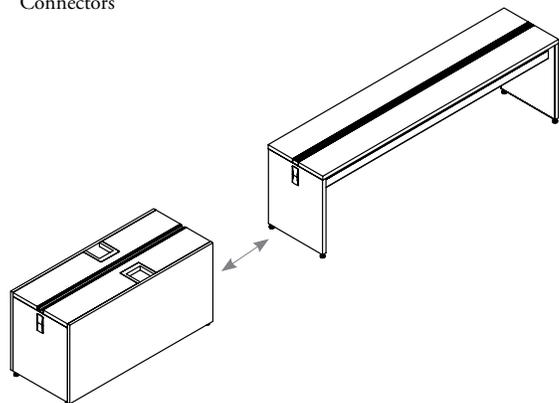



# stage module for height-adjustable table power distribution basics

Power & Data are distributed through the Stage Module for Height-Adjustable Table with Power Modules and Communication Boxes.

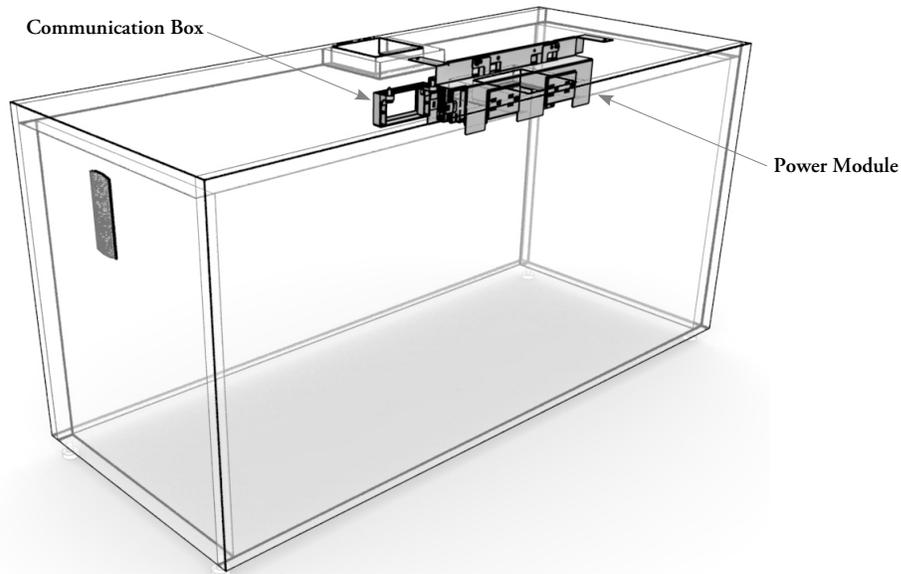

### Power Module for Height-Adjustable Stage (HTEPM)

- Mounts inside of the Stage Module for Height-Adjustable Table to accommodate the mounting of receptacles
- Wire system available:
  - 8-Wire Isolated Ground (8T)
  - 8-Wire Dual Isolated (8K)
- Mounting brackets included and available in Black only
- Outlets must be ordered separately and can be mounted to one or both sides of the Power Module for Single or Double Sided application
- See *Power Access Basics* page for Outlet details



### Communication Box (HTECB)

- The Communication Box is used on the Stage Module for Height-Adjustable Tables to accommodate data modules
- Opening measures 2.71" x 1.38" to accommodate Voice/Data jacks and faceplates (not included)
- Finished in Platinum



### Chicago Power Box for Height-Adjustable Stage Module (HTEPMC)

- Mounts inside of the Stage Module for Height-Adjustable Table to accommodate the mounting of receptacles in Chicago applications
- Available Single or Double Sided

# planning with stage module for height-adjustable table power access

The following should be considered when planning with Stage Module for Height-Adjustable Table Power Access.

## power routing to module for height-adjustable table

The Power Module for Height-Adjustable Stage mounts 6" off center and mounts to the underside of the Stage Module for Height-Adjustable Table Surface. The harness attaching to the module must be a minimum of half the length of the connecting Stage plus the remaining length determined by size and direction of the Module.

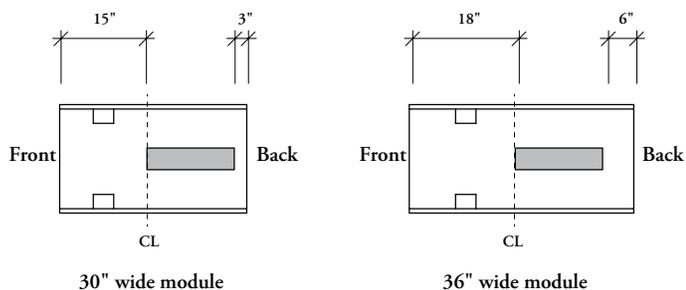

### Example 1

15" from left side of the Power Module for Height-Adjustable Stage + half the length of the connecting Stage (42") = 57" length (round up to 60" harness).

**60" long harness required**

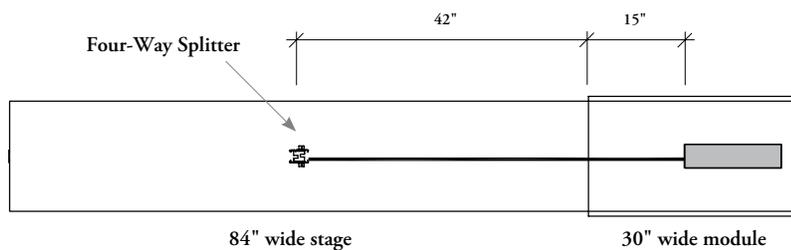

# planning with stage module for height-adjustable table power access (continued)

## power routing to module for height-adjustable table

The Power Module for Height-Adjustable Stage mounts 6" off center and mounts to the underside of the Stage Module for Height-Adjustable Table Surface. The harness attaching to the module must be a minimum of half the length of the connecting Stage plus the remaining length determined by size and direction of the Module.

### Example 2

3" from right side of the Height-Adjustable Power Module + half the length of the connecting Stage (42") = 45" length (round up to 48" harness).

#### 48" long harness required

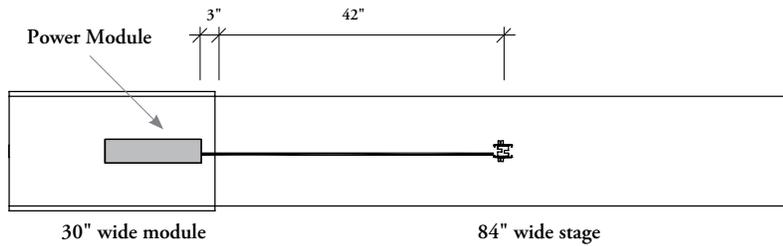

I-Connectors and Four-Way Splitters are not required when planning with the Power Module for Height-Adjustable Stage.

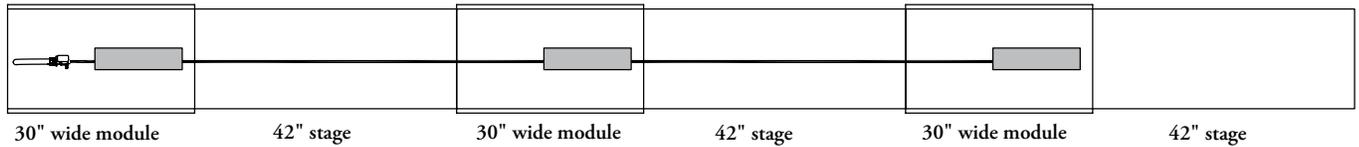

Each power module has two ins and two outs and can be used in combination with Flexible Power Module.

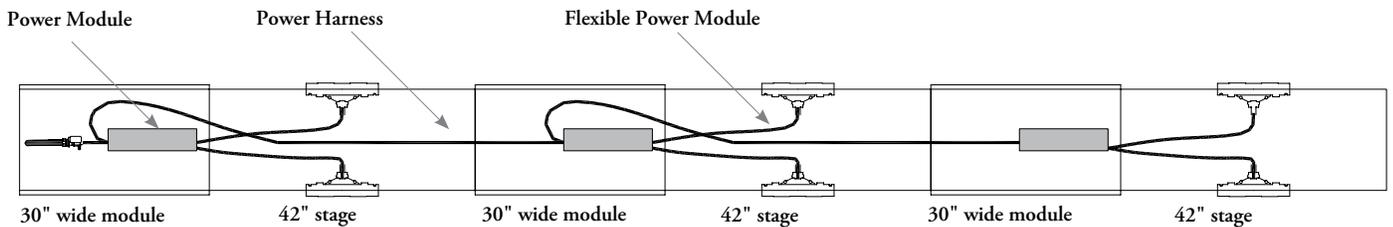

When connecting the Simple Stage to a Height-Adjustable Module, ensure 3" of harness can reach into the Height-Adjustable Module.

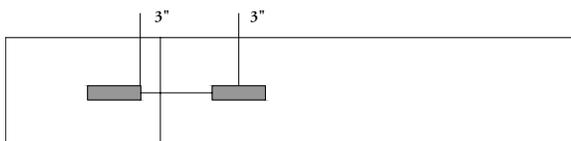
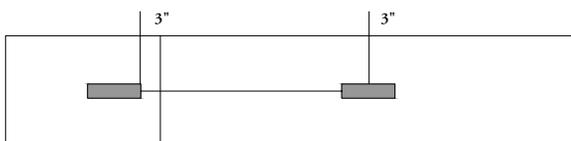

# credenza for height-adjustable table basics

Credenzas for Height-Adjustable Tables are available in a double and triple configuration and accommodate the leg of upStage Height-Adjustable Tables.

Triple Credenza for Height-Adjustable Table

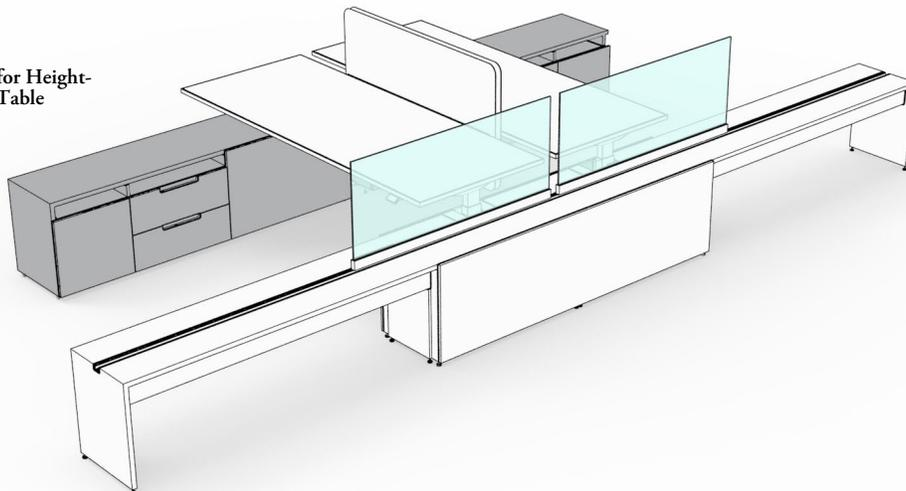

- Height is 21" high and depth is 16"
- Power and Data cannot be passed through Credenzas, it must route to Stage side
- upStage Navigate and hiSpace Height-Adjustable Tables can be used with these credenzas
- Orientation is determined from users perspective, sitting at the desk

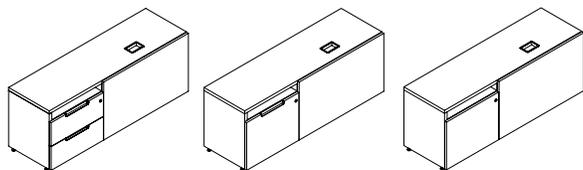

Double Credenza for Height-Adjustable Table (HTSCC)

- Widths: 48", 54" and 60"
- Configurations:
  - Box/Box
  - File
  - Hinged door
- Do **not** require counterweights

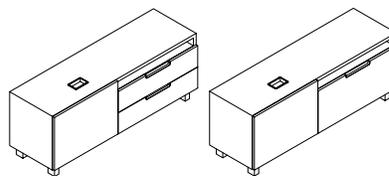

Height-Adjustable Integrated Double Credenza (HTSCD)

- Widths: 48" and 54"
- Configurations are specified left to right:
  - Box/Box
  - File
- Do **not** require counterweights

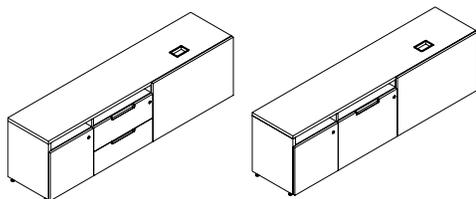

Triple Credenza for Height-Adjustable Table (HTSCT)

- Widths: 66" and 72"
- Hinged Door is always positioned at the outer end of the credenza with drawers being placed in the middle section
- Do **not** require counterweights

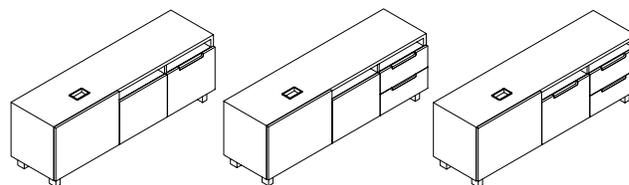

Height-Adjustable Integrated Triple Credenza (HTSCP)

- Widths: 54", 60", 66" and 72"
- Configurations are specified left to right:
  - Hinged Door/File (HF)
  - Hinged Door, Box/Box (HB)
  - File, Box/Box (FB)
- Do **not** require counterweights

# planning with credenzas for height-adjustable tables

## The following should be considered when planning with Credenzas for Height-Adjustable Tables.

Credenzas for height-adjustable tables have cut-outs and metal grommets to match upStage Navigate and hiSpace height-adjustable tables.

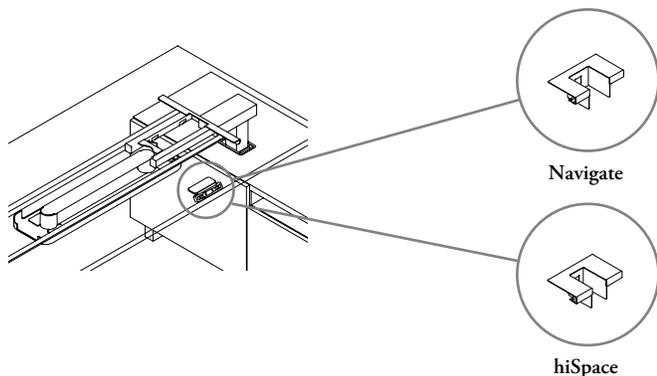

If an upStage Navigate or hiSpace Height-Adjustable Table is specified with T-Legs and Credenza (TCR/TCL), you can choose between the Double Credenza for Height-Adjustable Table (HTSCC) and the Triple Credenza for Height-Adjustable Table (HTSCT).

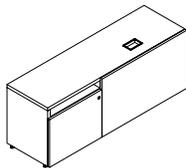

Double Credenza for Height-Adjustable Table (HTSCC)

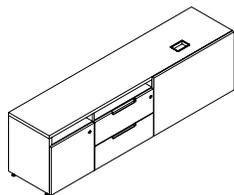

Triple Credenza for Height-Adjustable Table (HTSCT)

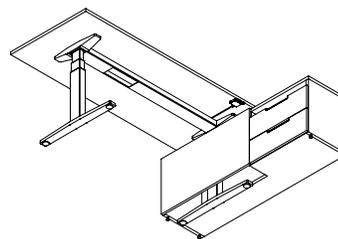

These two non-elevated credenzas hide a T-Leg foot. The storage starts right after the worksurface.

If the upStage Navigate Height-Adjustable Table is specified with Post and T-Legs (PTR/PTL), you can choose between the Height-Adjustable Integrated Double Credenza (HTSCD) and the Height-Adjustable Integrated Triple Credenza (HTSCP).

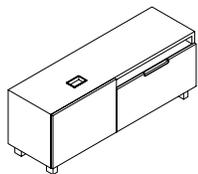

Height-Adjustable Integrated Double Credenza (HTSCD)

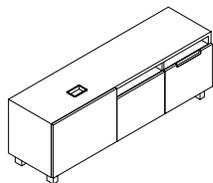

Height-Adjustable Integrated Triple Credenza (HTSCP)

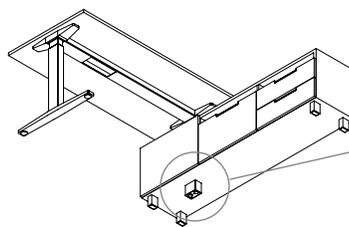

These two elevated credenzas hide a Post Leg. The storage tucks under the worksurface.

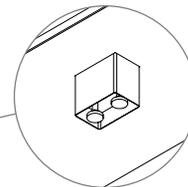

The Post Leg can be leveled through two standard levelers which work independently from the credenza

Height-Adjustable Integrated Double Credenza (HTSCD) and the Height-Adjustable Integrated Triple Credenza (HTSCP) are compatible with 30" deep upStage worksurfaces only.

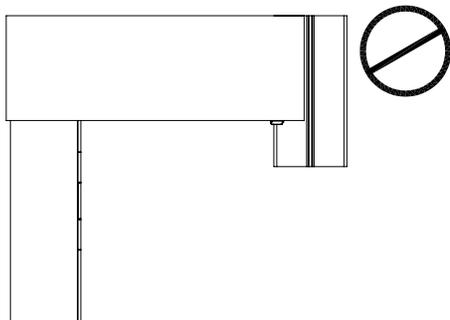

25" upStage Navigate worksurface.

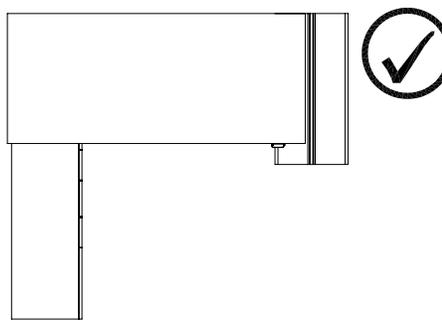

30" upStage Navigate worksurface.

# planning with credenzas for height-adjustable tables (continued)

It is recommended that 65", 71", 77" and 83" wide Rectangular Height-Adjustable Worksurface for upStage Navigate (WBU or WJU) be specified for enough clearance between credenza and stage.

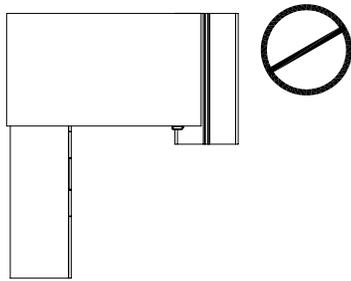

53" worksurface

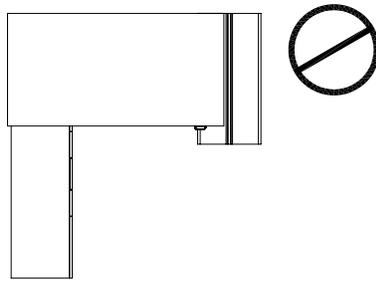

59" worksurface

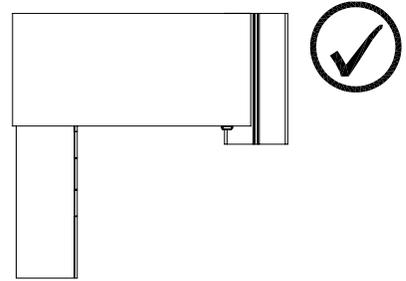

65" worksurface

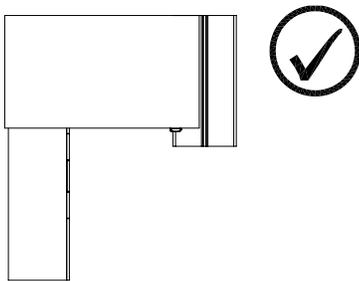

71" worksurface

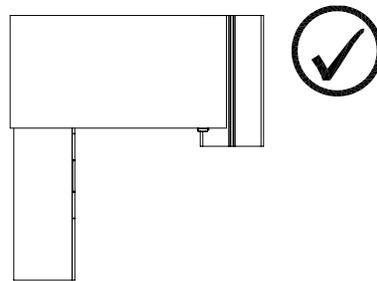

77" worksurface

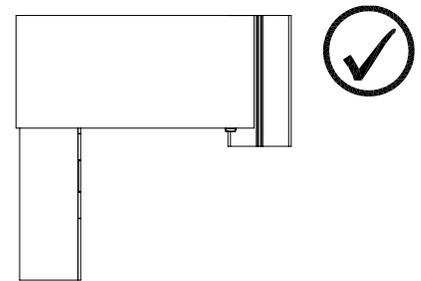

83" worksurface

It is recommended to plan with a grommet over the non-credenza side of a worksurface to avoid pinching wires and component interference.

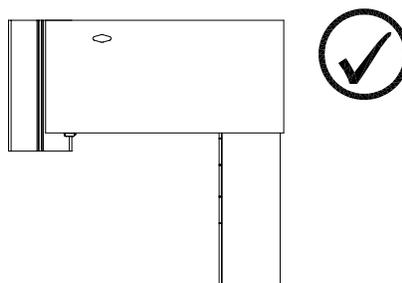
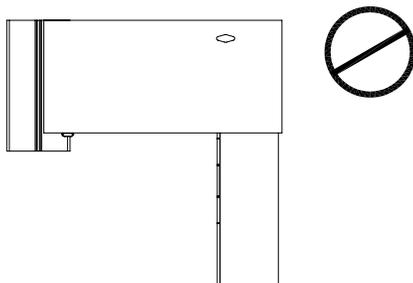

# planning with credenzas for height-adjustable tables (continued)

Power and data should always be routed through the stage side, not through the credenza side. If an Vertical Wire Carrier is specified, it must be specified to the non-credenza side.

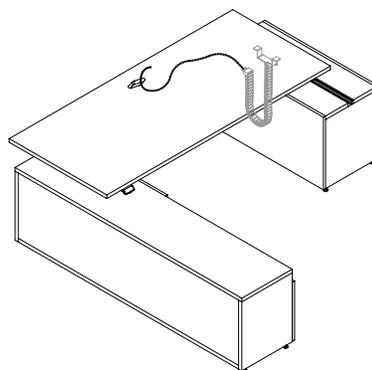
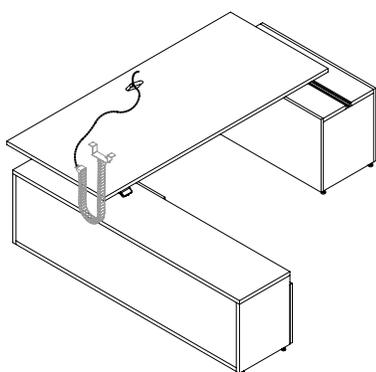

Credenza will not fit under the stage. Height-Adjustable worksurface cannot overlap edge.

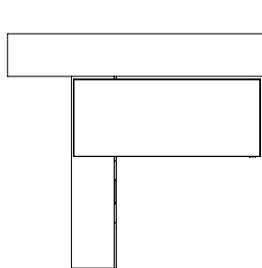

# planning with credenzas for height-adjustable tables (continued)

## hutches and stackers

Hutches and stackers must be 6" shorter than available space to provide adequate clearance between height adjustable worksurface and stationary hutch or stacker.

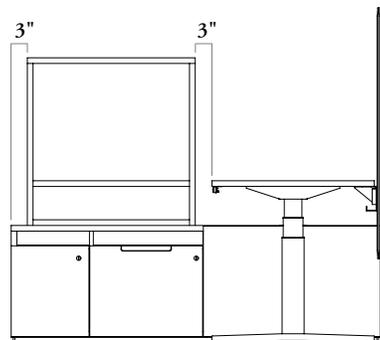

## workstation footprint

Workstations planned with stage and credenza are 1" wider and 1" - 3" deeper than standard footprint. For example, a 6'x6' workstation planned with a credenza will have a width of 73" and a depth of 73" - 75".

When planning face to face workstations with credenzas additional space is required between desks for screens and pinch gap (minimum 1")

Credenzas are not recommended for parallel planning as there are not enough space for circulation path.

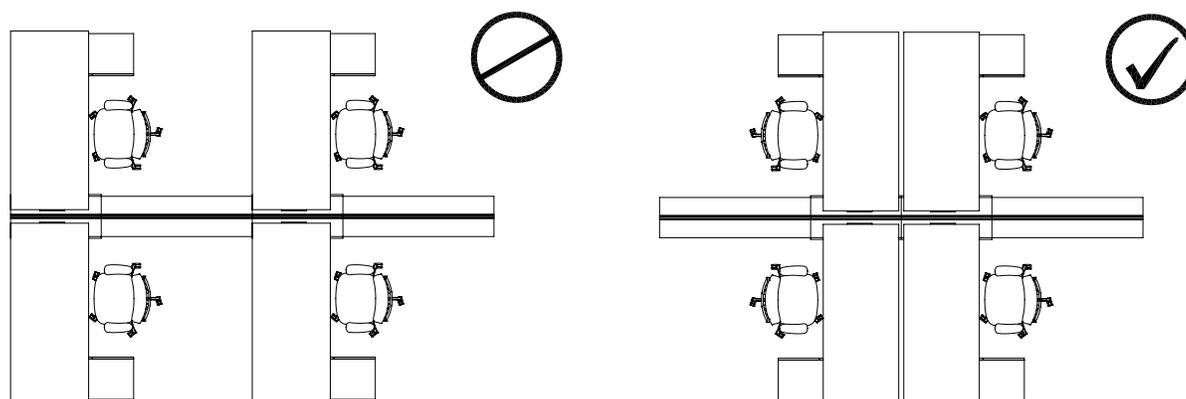

The overhang of the worksurface is 1" after the credenza edge. Worksurface edge will always be 2" offset inside from the center of the stage when leg is installed in stage module.

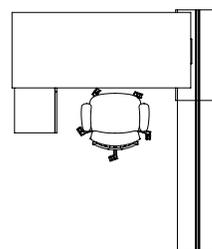
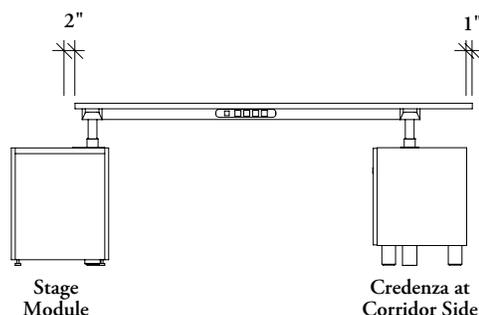

The width will be determined by the worksurface.

Depth of the worksurface is determined by screens used and the pinch gap required. The minimum 1" pinch point clearance is provided between screens to avoid pinch and accommodating cable routing. The gap between worksurface and screen will be 1/2".



# planning with credenzas for height-adjustable tables (continued)

## handedness

Handedness is determined from users point of view, in which side they are sitting at the desk.  
All credenzas for upStage Height-Adjustable Tables are available with right to left handedness.  
Credenza configuration must be specified left to right.

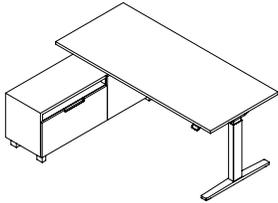

Left handed Height-Adjustable Integrated Double Credenzas (HTSCD)

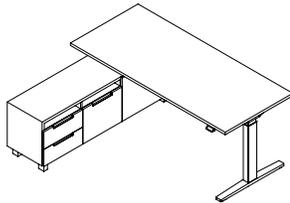

Left handed Height-Adjustable Integrated Triple Credenza (HTSCP)

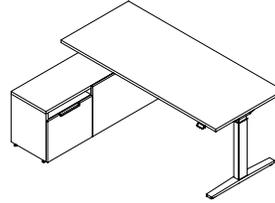

Left handed Double Credenza for Height-Adjustable Table (HTSCC)

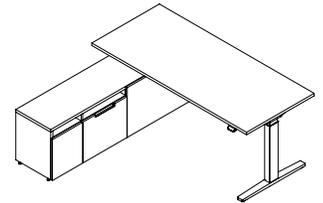

Left handed Triple Credenza for Height-Adjustable Table (HTSCD)

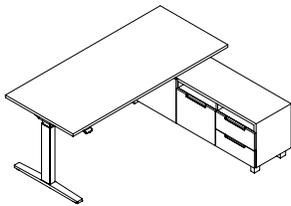

Right handed Height-Adjustable Integrated Double Credenzas (HTSCD)

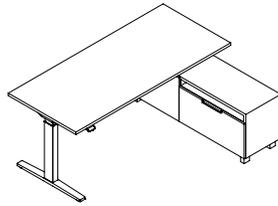

Right handed Height-Adjustable Integrated Triple Credenza (HTSCP)

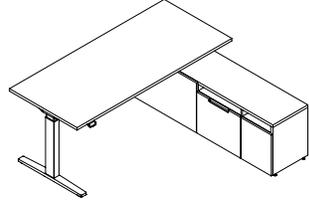

Right handed Double Credenza for Height-Adjustable Table (HTSCC)

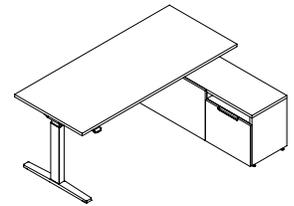

Right handed Triple Credenza for Height-Adjustable Table (HTSCD)

## planning with height-adjustable tables, credenzas and screens

upStage height adjustable worksurfaces and credenzas provide sufficient clearance for screens applications.

upStage hiSpace and Navigate Rectangular Height-Adjustable Worksurfaces for will have 2" overhang on the non-user side and 1" overhang on the corridor side.  
After integrating the upStage credenza, upStage hiSpace and Navigate Rectangular Height-Adjustable Worksurfaces will have 1" overhang on front and side, which avoids the conflict between credenza and screen.

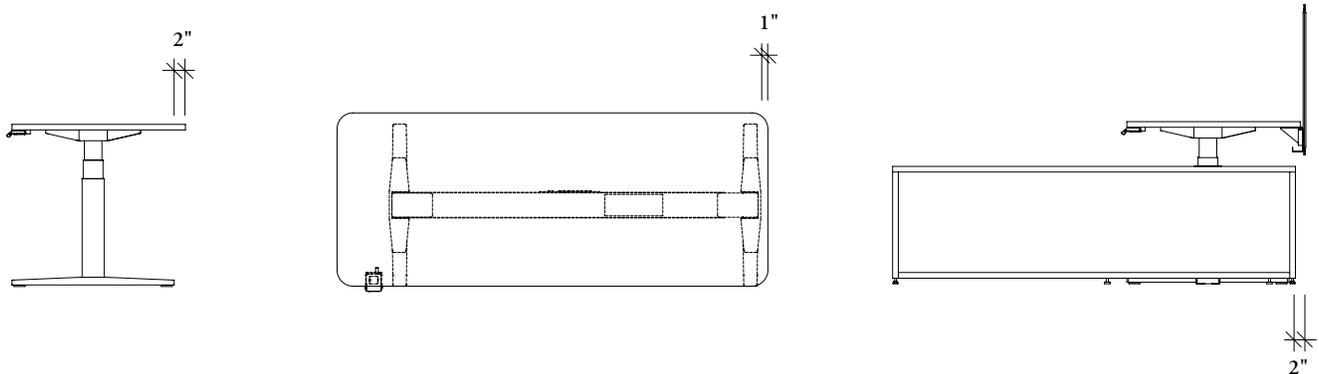

# planning with credenzas for height-adjustable tables (continued)

## maximum width of screen

There should be a 1" pinch gap between the stage module and a screen used with a height-adjustable work surface. The illustrations below show the maximum width of the screens that can be used with a height-adjustable work surface.

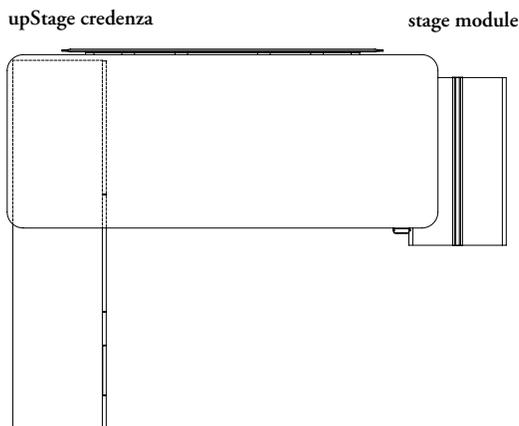

### Centered Screens

- 83" wide height-adjustable table = maximum screen width is 66"
- 77" wide height-adjustable table = maximum screen width is 60"
- 71" wide height-adjustable table = maximum screen width is 54"
- 65" wide height-adjustable table = maximum screen width is 48"
- 59" wide height-adjustable table = maximum screen width is 42" (credenzas not recommended with 59" worksurface)
- 53" wide height-adjustable table = maximum screen width is 36" (credenzas not recommended with 53" worksurface)

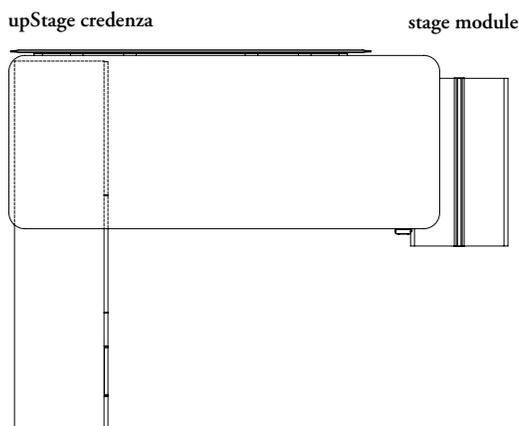

### Corridor Justified Screens

- 83" wide height-adjustable table = maximum screen width is 72"
- 77" wide height-adjustable table = maximum screen width is 68"
- 71" wide height-adjustable table = maximum screen width is 62"
- 65" wide height-adjustable table = maximum screen width is 56"
- 59" wide height-adjustable table = maximum screen width is 50" (credenzas not recommended with 59" worksurface)
- 53" wide height-adjustable table = maximum screen width is 44" (credenzas not recommended with 53" worksurface)

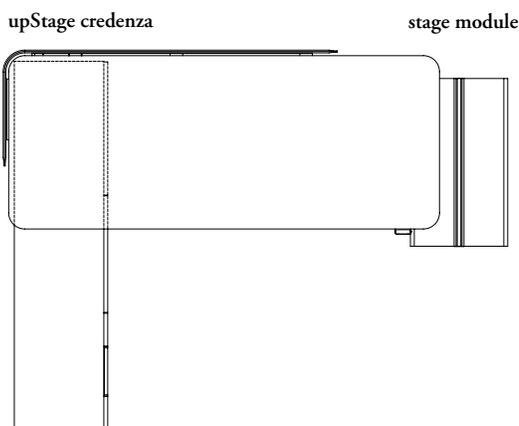

### Infinity Curved Screens

- 83" wide height-adjustable table = maximum screen width is 59"
- 77" wide height-adjustable table = maximum screen width is 59"
- 71" wide height-adjustable table = maximum screen width is 59"
- 65" wide height-adjustable table = maximum screen width is 53"
- 59" wide height-adjustable table = maximum screen width is 47" (credenzas not recommended with 59" worksurface)
- 53" wide height-adjustable table = maximum screen width is 41" (credenzas not recommended with 53" worksurface)



screens

# screens

UNDERSTANDING SCREENS . . . . .	110
CASUAL SCREEN BASICS . . . . .	112
PLANNING WITH CASUAL SCREENS . . . . .	113
DESK EDGE SCREEN BASICS . . . . .	115
PLANNING WITH DESK EDGE SCREENS . . . . .	119
DESK EDGE FLOOR SCREEN BASICS . . . . .	126
PLANNING WITH DESK EDGE FLOOR SCREENS . . . . .	127
DESK EDGE SCREENS WITH GLASS BASICS . . . . .	128
PLANNING WITH DESK EDGE SCREENS WITH GLASS . . . . .	129
MODESTY SCREEN BASICS . . . . .	130
SOLID LATERAL SCREEN BASICS . . . . .	131
PLANNING WITH SOLID LATERAL SCREENS . . . . .	132
SOLID CORRIDOR SCREEN BASICS . . . . .	134
PLANNING WITH SOLID CORRIDOR SCREENS . . . . .	135
LATERAL SCREEN BASICS . . . . .	138
FUNCTIONAL SCREEN BASICS . . . . .	139
PLANNING WITH FUNCTIONAL SCREENS . . . . .	141

## understanding screens

upStage offers a variety of screens at varying heights and available in multiple materials. The screens provide various levels of casual privacy and functionality.

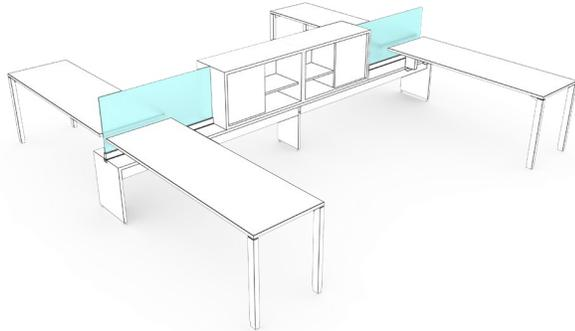

### casual screens

- Casual Screens mount to the Accessory Beam on the Stage to provide space division
- Available in six styles:
  - Glass
  - Solid
  - Thick Solid
  - Solid with Glass
  - Infinity
  - Framed
- Solid and Thick Solid Screens with rail can accommodate hanging accessories

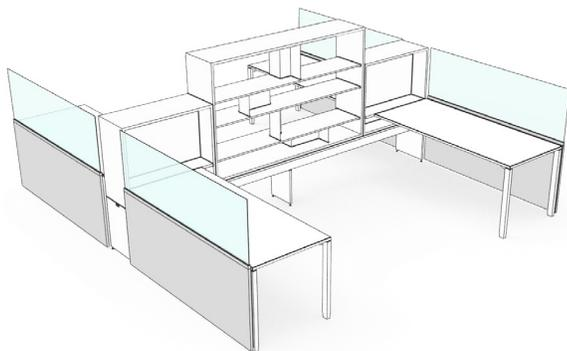

### desk edge screens

- Mounts on-or off-module to the edge of single return worksurfaces
- Creates space division and local desktop privacy at various heights
- Desk Edge Screens are available in six styles:
  - Glass
  - Solid
  - Solid with Glass
  - Infinity
  - Framed
  - Smooth Felt Desk Edge Screens
- Smooth Felt Screen with a lightweight aesthetic
  - Available in Complements: *Teknion's Ergonomics & Accessories Program*

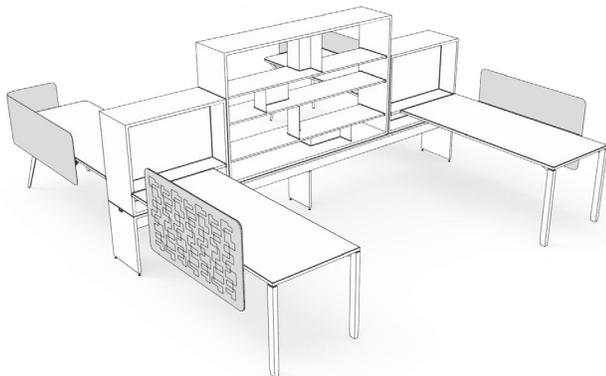

### infinity desk edge screens

- Attaches to worksurfaces to provide a lightweight, thin upholstered fabric screen
- Provides privacy at 42"h, 51"h and 57"h
- Provides a softer curvilinear aesthetic
- Creates space division and local desktop privacy at various heights
- Available in four styles:
  - Curved
  - Desk Edge
  - Quilted
  - Side Desk Edge

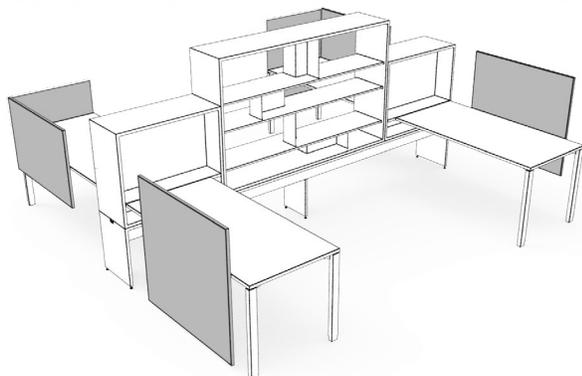

### framed fabric desk edge screens

- Attaches to worksurfaces to provide an upholstered fabric screen
- Provides privacy at 42"h, 51"h and 57"h
- Is outlined by a frame
- Creates space division and local desktop privacy at various heights
- Above and below the worksurface
- Available in two styles:
  - Desk Edge
  - Side Desk Edge

## understanding screens (continued)

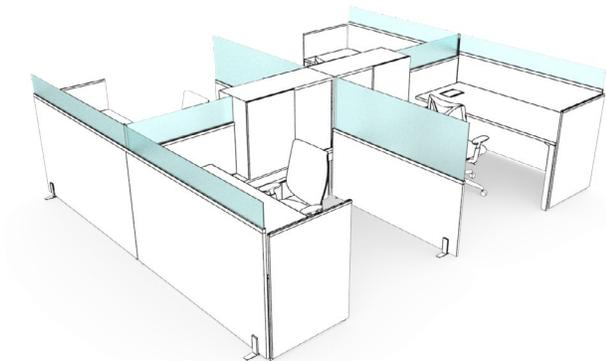

### solid lateral screens

- Solid Lateral Screens mount perpendicular to the spine to provide space division
- Available in two styles:
  - Solid
  - Solid with Glass
- Various heights available to match datum heights along screens and storage on the stage

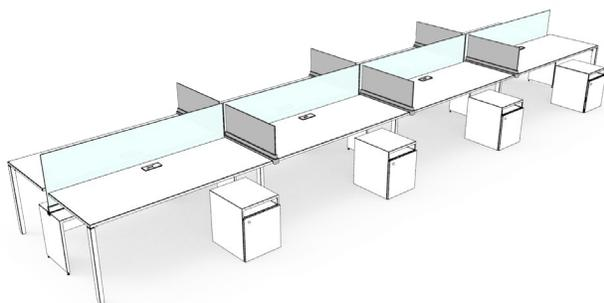

### lateral screens

- Lateral Screens attach to the worksurface to provide lateral space division
- Available with a straight/curved profile
- Five different finishes available:
  - Glass
  - Writable solid surface
  - Smooth Felt
  - Fabric
  - Metal

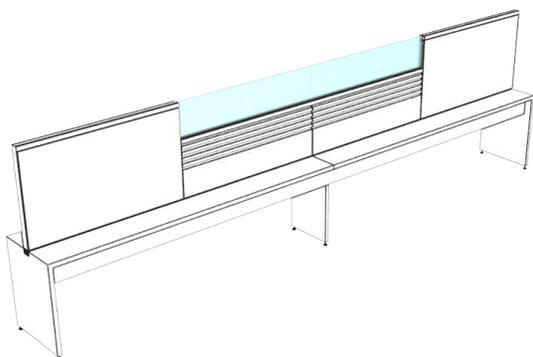

### functional screens

- Functional Screens are a panel like structure with fascias that provide privacy and functionality
- Functional Screen fascia finishes available:
  - Fabric
  - Whiteboard
  - Accessory Fascias
  - Glass Add-ons

## casual screen basics

Casual Screens mount to the Accessory Beam on the Stage to provide space division.

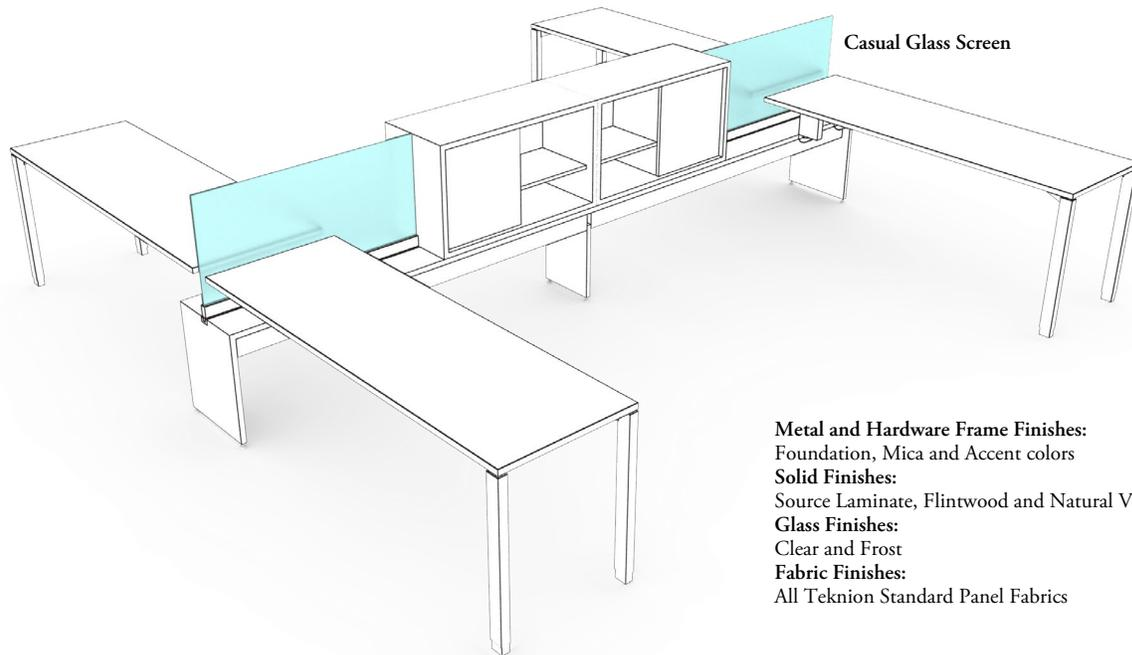

**Metal and Hardware Frame Finishes:**  
Foundation, Mica and Accent colors  
**Solid Finishes:**  
Source Laminate, Flintwood and Natural Veneer  
**Glass Finishes:**  
Clear and Frost  
**Fabric Finishes:**  
All Teknion Standard Panel Fabrics

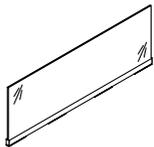

### Casual Glass Screen (HTNX)

- Provides glass space division along the Accessory Beam of the stage
- Heights:
  - 21" high for a 42" high datum
  - 30" high for a 51" high datum
- Widths: 24" - 96" in 6" increments
- Available in 6mm or 10mm
- 6mm is not available on 30" high Screen



### Casual Solid Screen (HTND)

- Provides solid space division along the Accessory Beam of the stage
- Available with or without Accessory Rail at the top
- Heights:
  - 21" high for a 42" high datum
  - 30" high for a 51" high datum
- Widths: 24"-96" in 6" increments

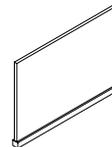

### Casual Thick Solid Screen (HTNJ)

- Provides solid space division along the Accessory Beam of the stage
- Available with or without Accessory Rail at the top
- Heights:
  - 21" high for a 42" high datum
  - 30" high for a 51" high datum
  - 36" high for a 57" high datum
- Widths: 24" - 96" in 6" increments
- Available with three alignment options:
  - Without Alignment
  - With In-Line Alignment
  - End Alignment



### Casual Thick Solid Screen with Glass (HTNK)

- Provides solid space division along the Accessory Beam of the stage
- Heights:
  - 51" (42" plus 9" glass)
  - 57" (48" plus 9" glass)
- Widths: 24"-96" in 6" increments
- Available with three alignment options:
  - Without Alignment
  - With In-Line Alignment
  - End Alignment



### Casual Infinity Screen (GXAU)

- Provides solid space division along the Accessory Beam of the stage or on worksurface
- Heights:
  - 21" high for a 42" high datum
  - 30" high for a 51" high datum
- Widths: 24"-72" in 6" increments
- Applications:
  - Stage Mount
  - Worksurface Mount

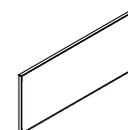

### Casual Framed Fabric Screen (HTNB)

- Provides tackable fabric space division along Accessory Beam of the stage
- Heights:
  - 13" high for a 42" high datum Worksurface Mount
  - 21" high for 42" high datum Stage Mount
  - 22" high for 51" high datum Worksurface Mount
- Widths: 24" - 72" in 6" increments
- Applications:
  - Stage Mount
  - Worksurface Mount



# planning with casual screens

The following should be considered when planning with Casual Screens.

## casual screen datum heights

- Casual Screens match standard Teknion datum heights of 42", 51" and 57" when mounted on the stage
- Alignment clips are provided

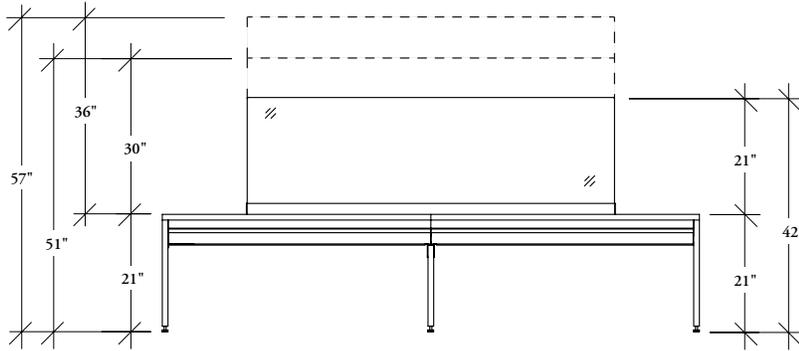

## casual thick solid screens

- Casual Thick Solid Screens can be specified with or without alignment holes for added stability for longer runs
- When multiple screens are ganged together, alignment kits are supplied

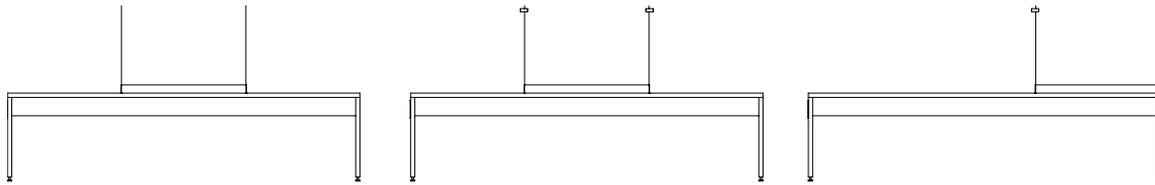

- No Alignment
  - No Alignment holes
  - Two end caps
- With In-Line Alignment
  - Alignment holes both sides
  - No End Caps
- End Alignment, holes one side, one end cap
  - Alignment holes one side
  - No End Caps

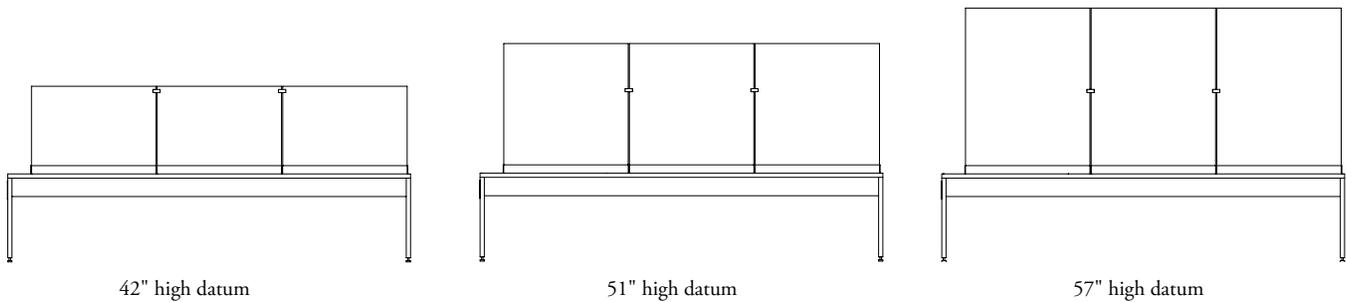

Casual Thick Solid Screens, 42", 51" and 57" datum heights can be placed along the stage side by side.

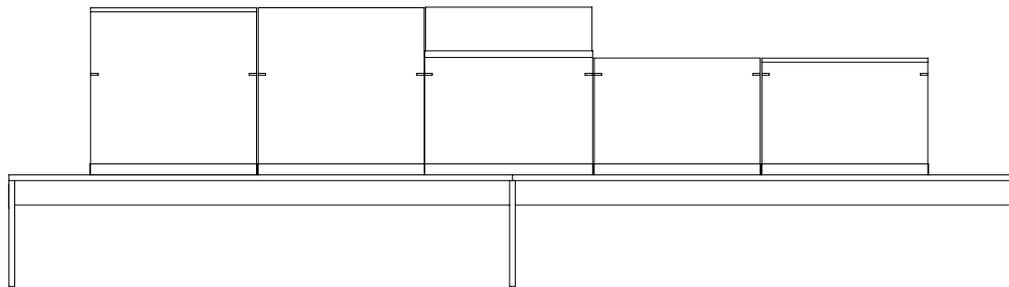

## planning with casual screens (continued)

### casual thick solid screens with accessories

- Sit and Slide Screens with Accessories (JNSSE) can be used on a casual thick solid screen without a accessory rail
- The datum heights are 44" and 53" and cannot be used on any other screen type
- Casual Solid Screens and Casual Thick Solid Screens with an accessory rail can accommodate
  - Personal Organizers (PAX)
  - fx Accessories (with the exception of the fx Letter Tray (YFGY))
- The accessory rail can accept up to a 5 lb load

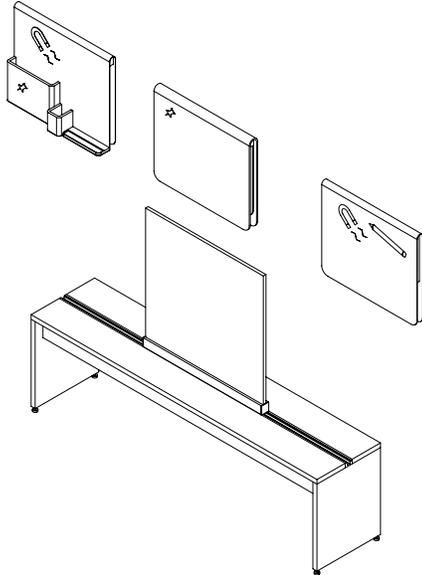

Sit and Slide Screens with Accessories (JNSSE)

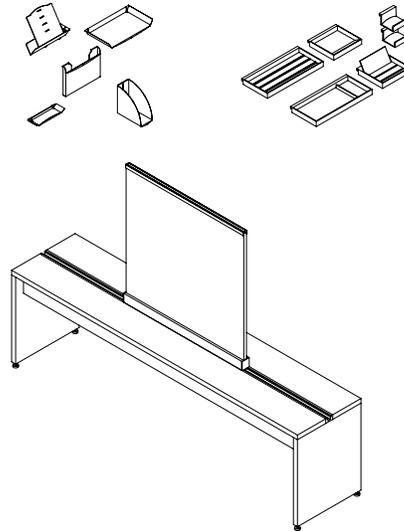

Personal Organizers (PAX) and fx Accessories

### casual infinity and framed screens

- Casual Infinity and Casual Framed Screens can be specified side by side on a stage
- When Casual Infinity Screens are ganged together, Infinity Screen Alignment Clip (GXCC) must be specified separately

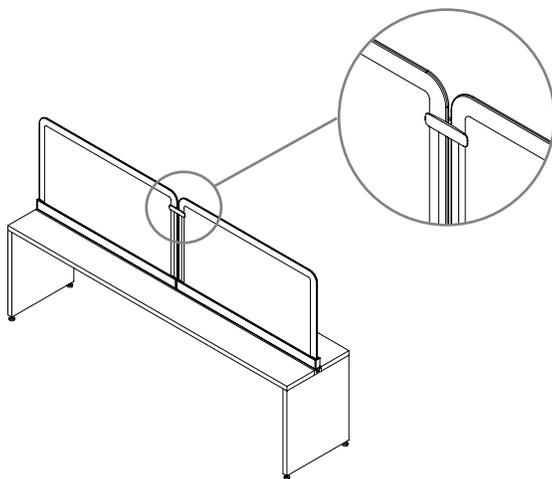

Casual Infinity Screens (GXAU)

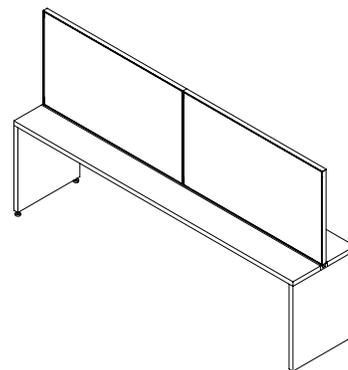

Casual Framed Fabric Screens (HTNB)

# desk edge screen basics

Desk Edge Screens mount to worksurfaces on- and off-module to provide privacy.

## glass and solid desk edge screens

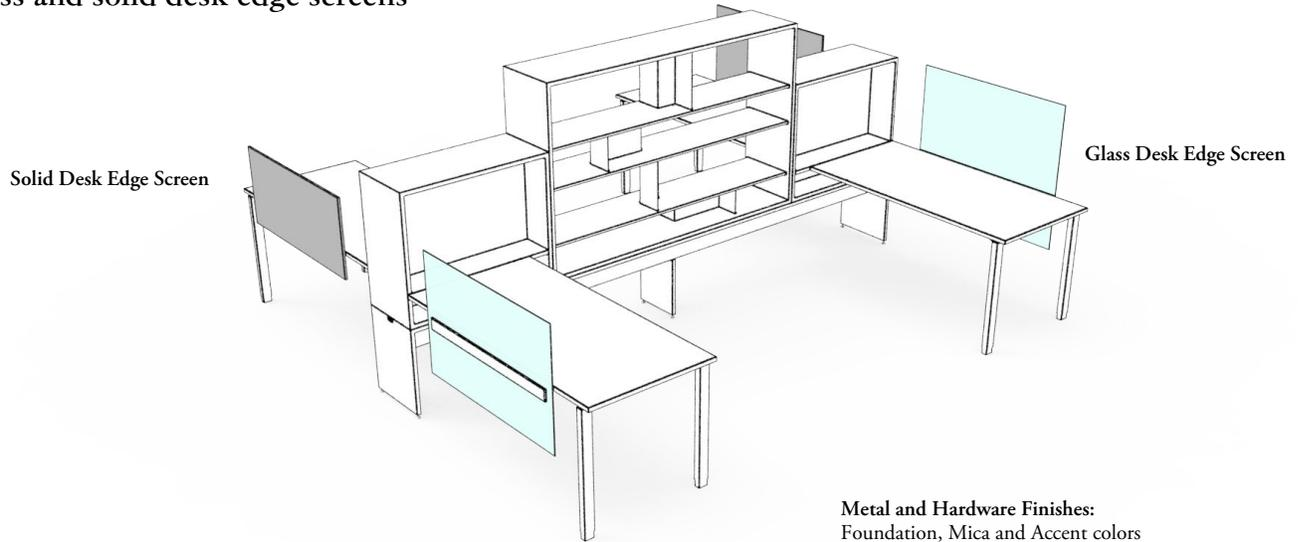

- Metal and Hardware Finishes:**  
Foundation, Mica and Accent colors
- Solid Finishes:**  
Source Laminate, Flintwood and Natural Veneer
- Glass Finishes:**  
Clear and Frost
- Fabric Finishes:**  
All Teknion Standard Panel Fabrics

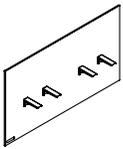

### Glass Desk Edge Screen (HTNG)

- Heights above worksurface:
  - 13" for a 42" high datum
  - 22" for a 51" high datum
  - 28" for a 57" high datum
- Modesty Base Heights:
  - Modesty Height (15")
- Widths:
  - 30" - 66" in 6" increments
- Glass thickness is 6mm or 10mm
- Provides privacy at 42", 51 & 57" height

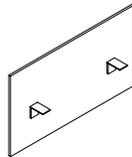

### Solid Desk Edge Screen (HTNS)

- Heights above worksurface:
  - 0" for a 29" high datum
  - 13" for a 42" high datum
  - 22" for a 51" high datum
  - 28" for a 57" high datum
- Modesty Base Heights:
  - Partial Modesty Height (23")
  - Modesty Height (15")
  - Elevated Height (6")
  - Floor Height (1")
- Available widths:
  - 30" - 66" in 6" increments
- Available with or without an Accessory Rail along the top
- If 0" (29" high) is specified the Accessory Rail is not available
- Provides privacy at 42", 51 & 57" height

## desk edge screen basics (continued)

### infinity desk edge screens

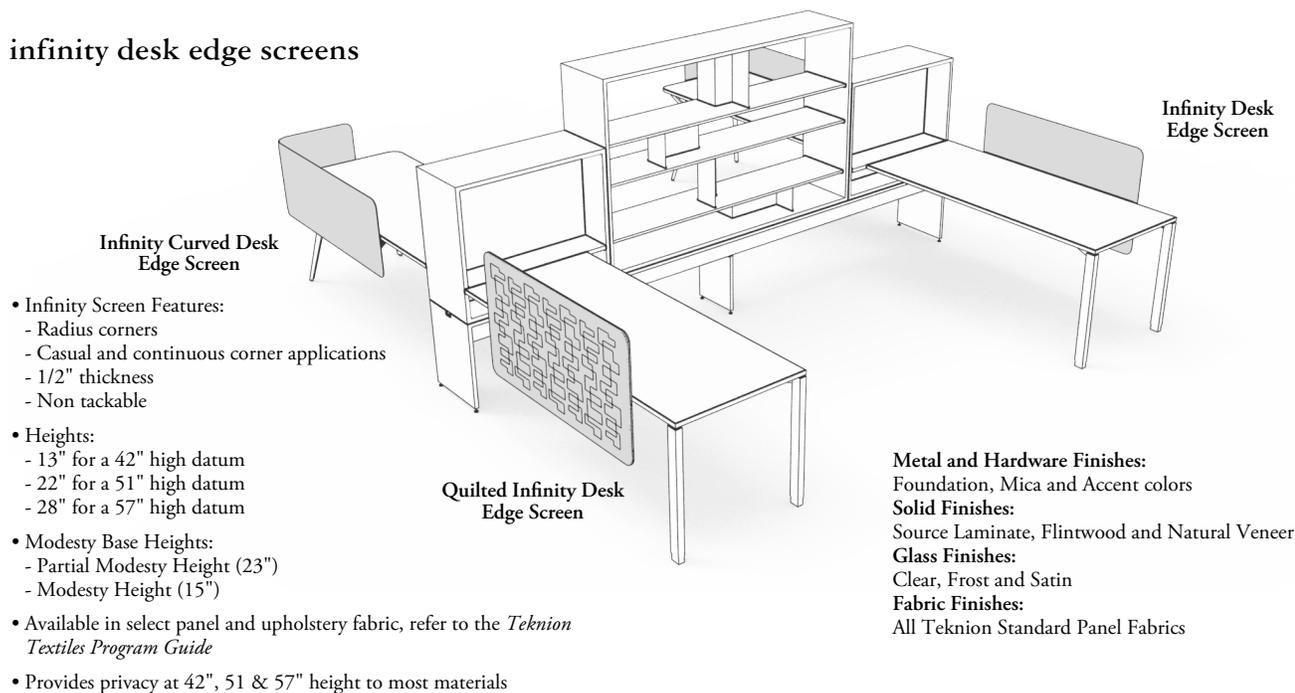

**Infinity Curved Desk Edge Screen**

- Infinity Screen Features:
  - Radius corners
  - Casual and continuous corner applications
  - 1/2" thickness
  - Non tackable

- Heights:
  - 13" for a 42" high datum
  - 22" for a 51" high datum
  - 28" for a 57" high datum

- Modesty Base Heights:
  - Partial Modesty Height (23")
  - Modesty Height (15")

- Available in select panel and upholstery fabric, refer to the *Teknion Textiles Program Guide*

- Provides privacy at 42", 51" & 57" height to most materials

**Quilted Infinity Desk Edge Screen**

**Metal and Hardware Finishes:**

Foundation, Mica and Accent colors

**Solid Finishes:**

Source Laminate, Flintwood and Natural Veneer

**Glass Finishes:**

Clear, Frost and Satin

**Fabric Finishes:**

All Teknion Standard Panel Fabrics

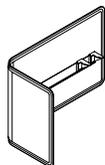

**Infinity Curved Desk Edge Screen (GXCU)**

- A curved fabric screen that mounts to a radiused corner worksurface
- Depths: 20"
- Widths:
  - 23", 29", 35", 41", 47", 53" and 59"
- Optional wire manager

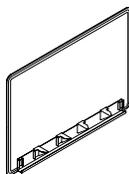

**Infinity Desk Edge Screen (GXDU)**

- A fabric screen that mounts to the edge of a worksurface
- Widths:
  - 36" to 71" in 1" increments
- Optional wire manager

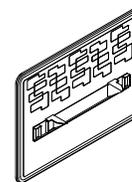

**Quilted Infinity Desk Edge Screen (GQDU)**

- A quilted fabric screen that mounts to the edge of a worksurface
- Widths:
  - 36" to 66" in 1" increment and 71"
- Optional wire manager

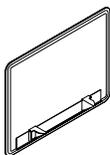

**Infinity Side Desk Edge Screen (GXSU)**

- A fabric screen that mounts to the side edge of a worksurface
- Widths:
  - 17", 18", 23", 24", 29", 30", 31", 35", 36", 42", 48", 60" and 72"



**Infinity Screen Alignment Clip (GXCC)**

- Used to clip Infinity screens together in side-by-side applications

# desk edge screen basics (continued)

## framed desk edge screens

**Framed Side Desk Edge Screen**

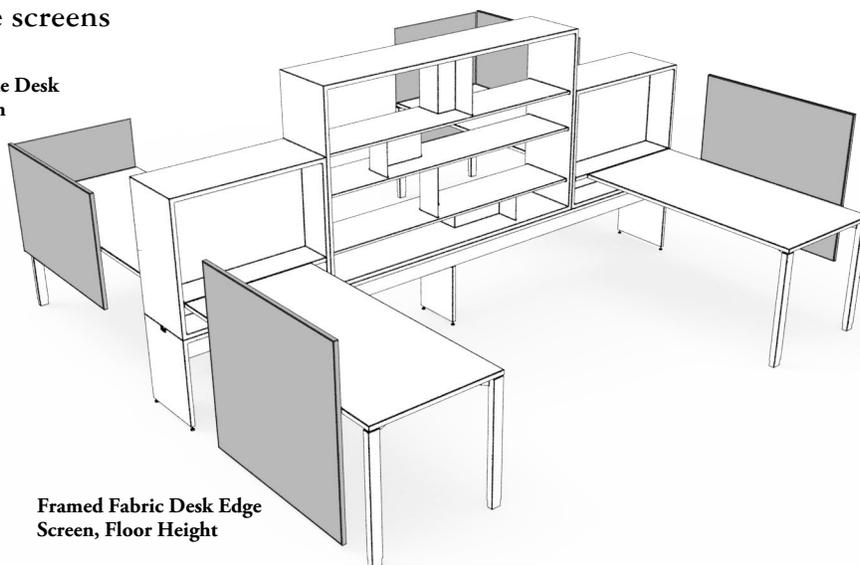

**Framed Fabric Desk Edge Screen**

**Framed Fabric Desk Edge Screen, Floor Height**

- Square Corners
- Tackable
- 1" Thickness
- Tight fit corner application
- Select Panel Fabric and Upholstery Fabric available for application. See *Teknion's Fabrics & Finishes Program* for more information

**Metal and Hardware Finishes:**

Foundation, Mica and Accent colors

**Solid Finishes:**

Source Laminate, Flintwood and Natural Veneer

**Glass Finishes:**

Clear, Frost and Satin

**Fabric Finishes:**

All Teknion Standard Panel Fabrics

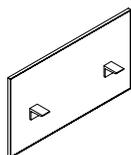

**Framed Fabric Desk Edge Screen (HTNF)**

- Heights above worksurface:
  - 13" for a 42" high datum
  - 22" for a 51" high datum
  - 28" for a 57" high datum
- Modesty Base Heights:
  - Modesty Height (15")
  - Elevated Height (6")
  - Floor Height (1")
- Widths:
  - 36" to 72" in 1" increments
- If Floor Modesty Base Height is specified, 22" high for a 51" datum is not available
- Provides privacy at 42", 51 & 57" height

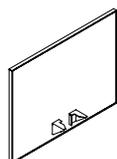

**Framed Side Desk Edge Screen (GYSU)**

- Heights above worksurface:
  - 13" for a 42" high datum
  - 22" for a 51" high datum
- Modesty Base Heights: Modesty Height (15")
- Depths: 20"
- Widths:
  - 23", 29", 35", 41", 47", 53" and 59"
- Provides privacy at 42", 51 & 57" height

# desk edge screen basics (continued)

## smooth felt desk edge screens

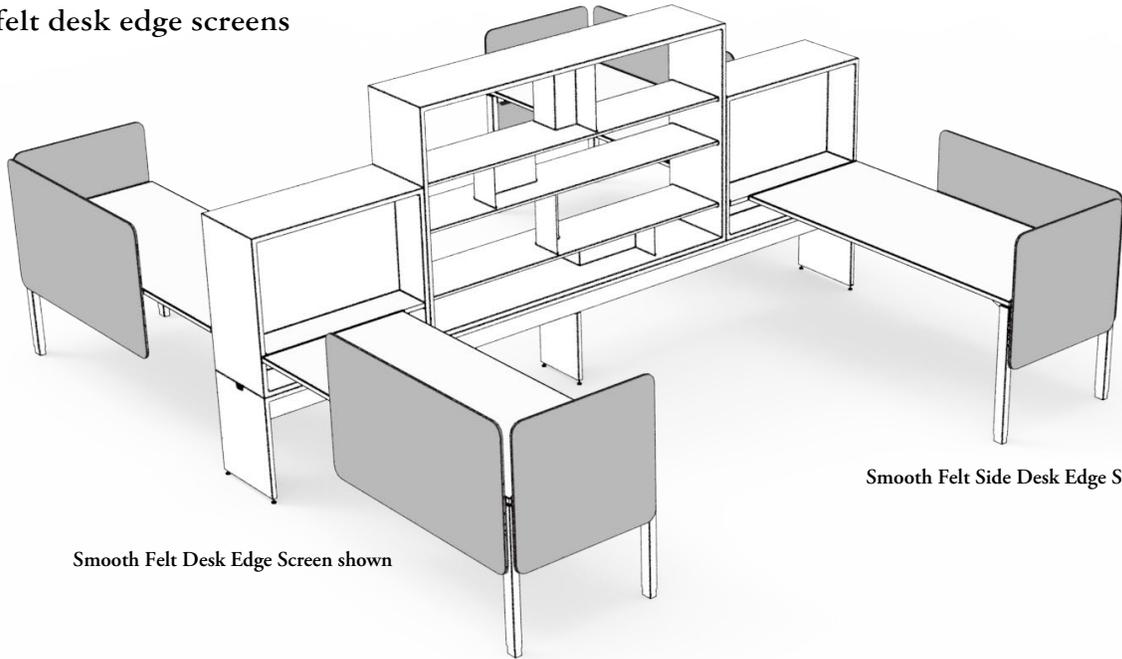

Smooth Felt Desk Edge Screen shown

Smooth Felt Side Desk Edge Screen shown

The Smooth Felt Screens can be used on upStage worksurfaces.  
They are available in Complements: *Teknion's Ergonomics & Accessories Program*

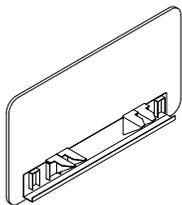

Smooth Felt Desk Edge Screen (GZDH)

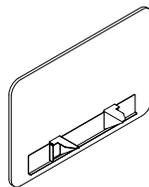

Smooth Felt Side Desk Edge Screen (GZSH)

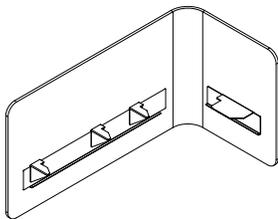

Smooth Felt Curved Radius  
Desk Edge Screen (GZCH)

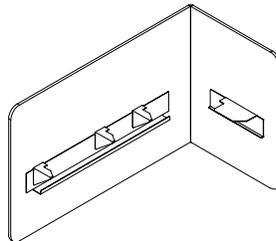

Smooth Felt Square Corner  
Desk Edge Screen (GZBH)

# planning with desk edge screens

The following should be considered when planning with upStage Desk Edge Screens.

The following are all of the possible datum and modesty heights for Desk Edge Screens.  
Refer to each individual screen for the list of specific heights available for that screen.

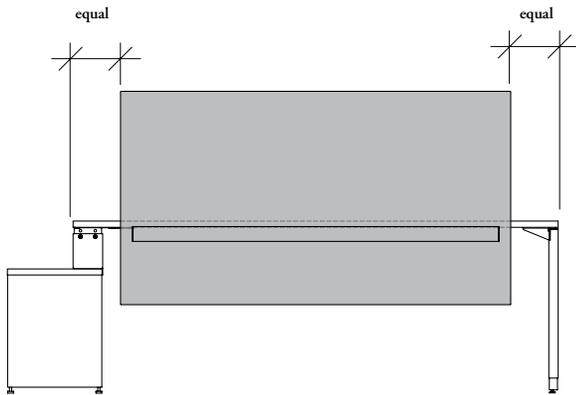
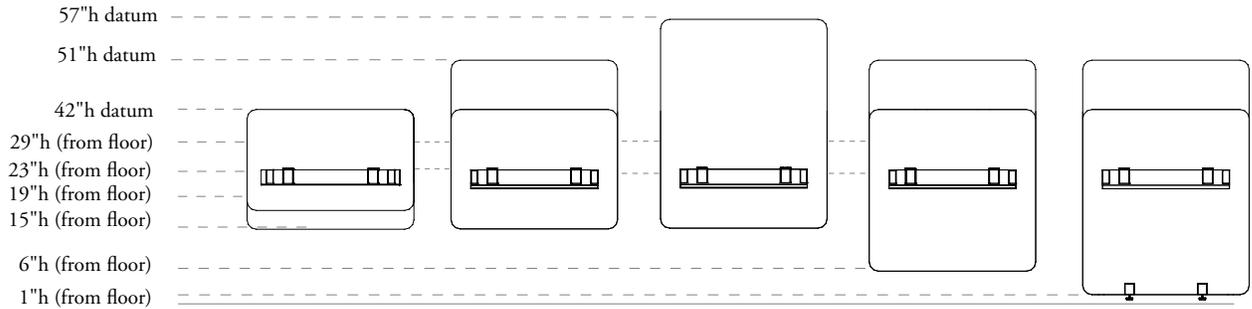

For 15" high Desk Edge Screens on worksurfaces semi-suspended from the stage or freestanding, it is recommended that the Screens be centered and be minimally 16" smaller than the worksurface to avoid interference with the stage.

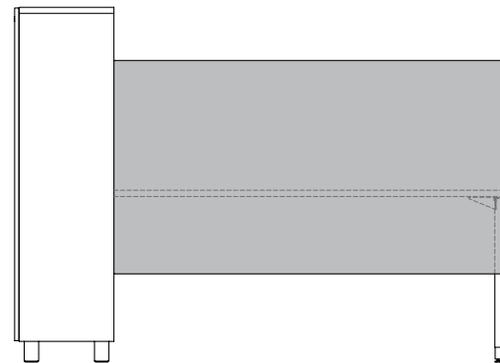

For Desk Edge Screens for worksurfaces semi-suspended from storage or a hutch, screens can be flush with the worksurface edge. If the width is shorter than the worksurface width, it is recommended that it be centered on the worksurface.

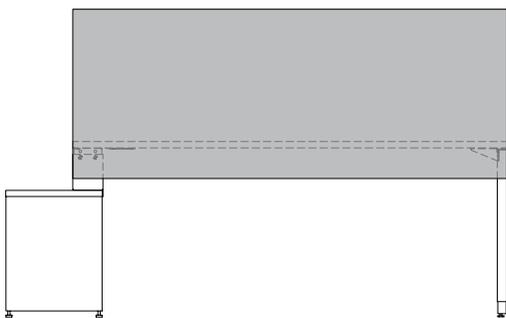

When Partial Modesty Height is specified, Solid Desk Edge Screens can be specified the full width of the worksurface as they will not interfere with the stage.

# planning with desk edge screens (continued)

## infinity screens

The following applications are available when planning with infinity screens.

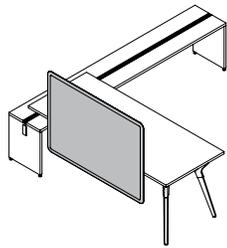

Desk Edge Screen

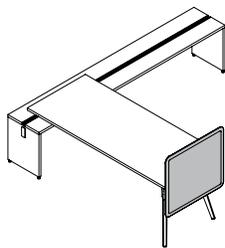

Side Desk Edge Screen

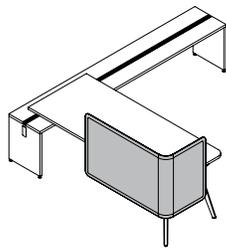

Curved Desk Edge Screen

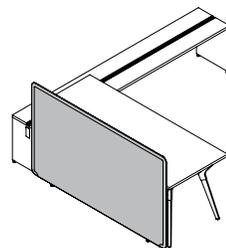

Desk Edge Floor Screen

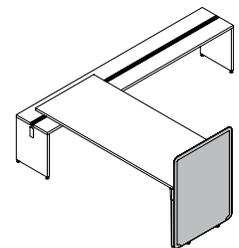

Side Desk Edge Floor Screen

Infinity Screen widths are nominal.  
 • The actual width is 1/4" less on each side

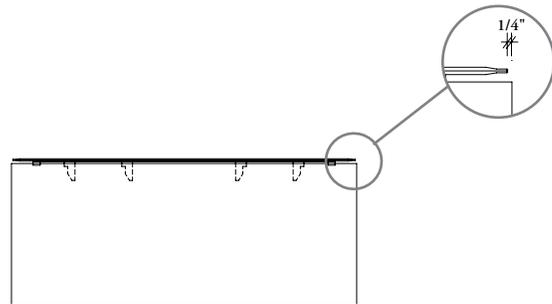

When two screens are planned side by side, there will be a 1/2" gap between the two screens.  
 • Screen Alignment Clips (GXCC) are used to align the two parallel screens

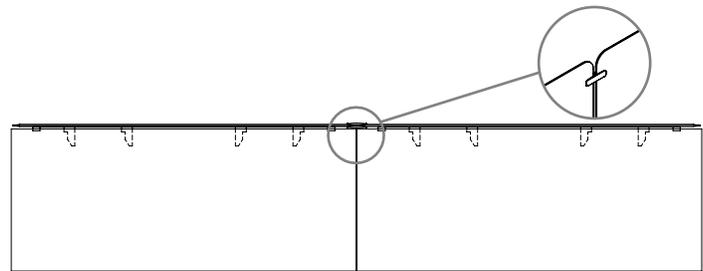

Infinity screens have no physical connection at corners. They are a casual fit.

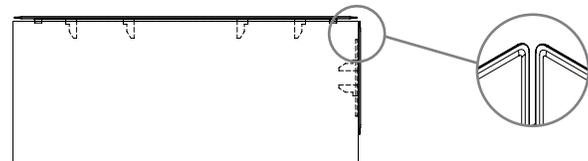

The brackets on infinity screens will always have a common bracket placement of 4 1/2" from either edge

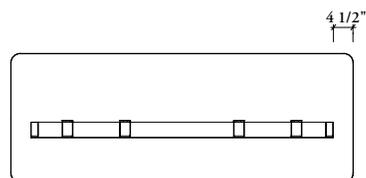

There are two types of patterns available when planning with the Quilted Infinity Desk Edge Screens:

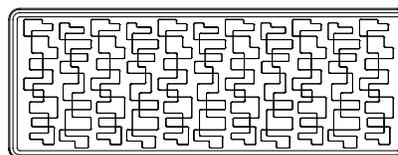

Diode

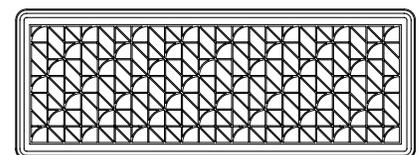

Pico



## planning with desk edge screens (continued)

Infinity Desk Edge Screens (GXDU) can be attached to worksurfaces in the following applications.

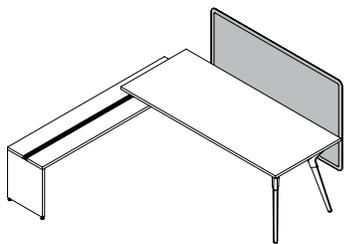

Worksurface with Stage Module or Credenza

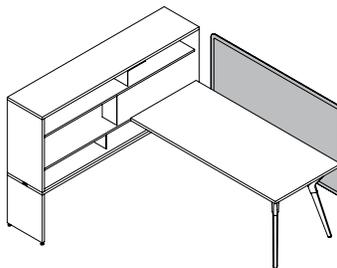

Worksurface with Hutch Stacker

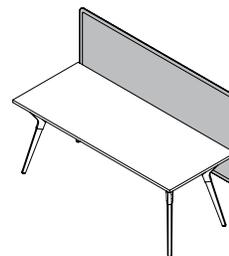

Freestanding Worksurface

Infinity Desk Edge Screens should only be placed on worksurfaces mounted perpendicular to the stage.

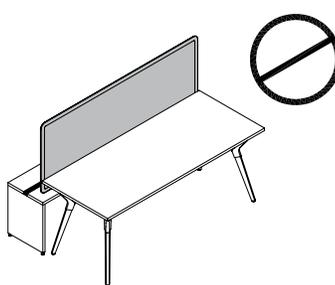
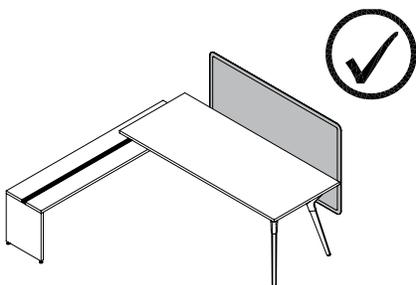

Two leg styles can be used with the Infinity Desk Edge Screen:

- Y-Leg (HTWD) (shown)
- Interpret Leg (HTWN)

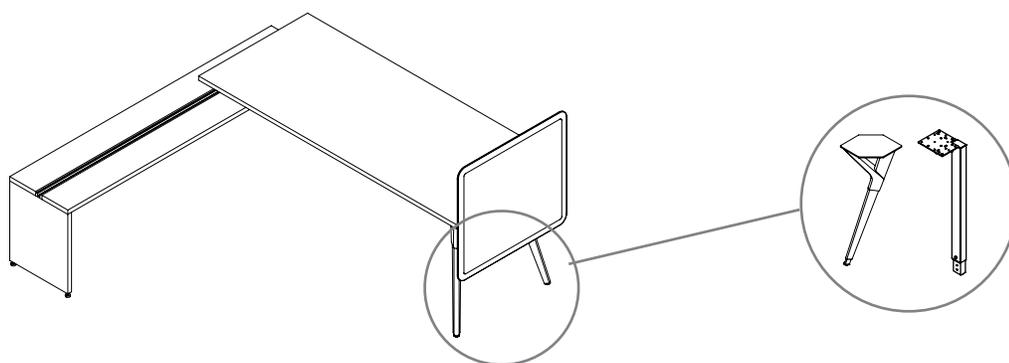

# planning with desk edge screens (continued)

The following should be considered when planning with Infinity Desk Edge Screens:

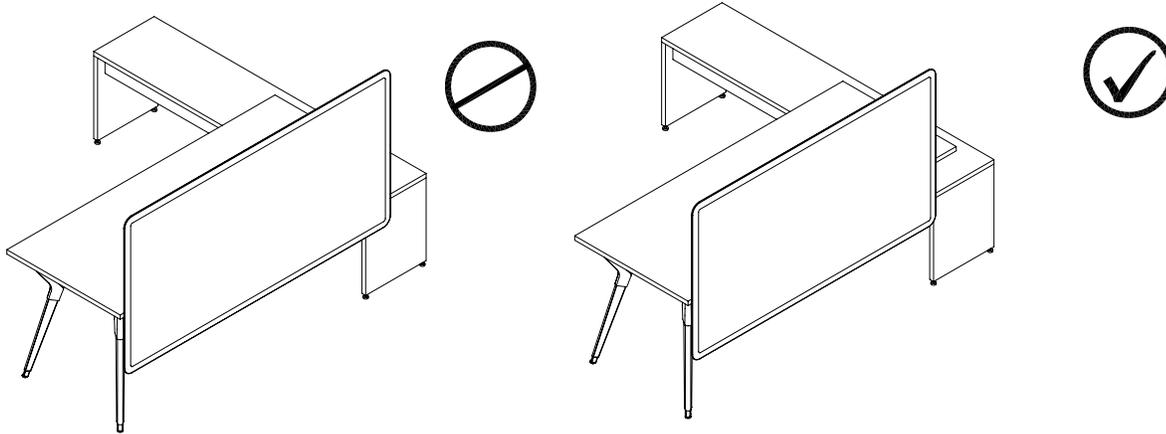

Perpendicular Worksurface (HTWP) with Infinity Desk Edge Screen (GXDU).

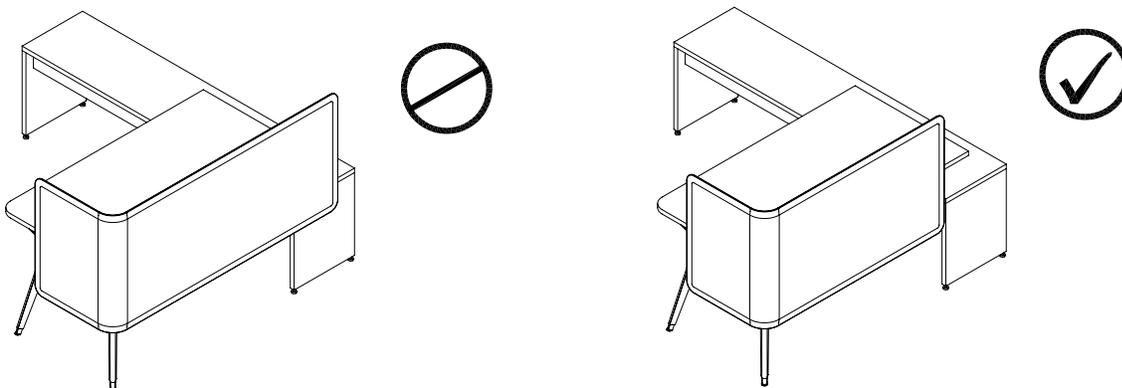

Perpendicular with Radius Corner Worksurface (HTWH) with Infinity Curved Desk Edge Screen (GXCU).

## planning with desk edge screens (continued)

Infinity Side Desk Edge Screens can be planned at both partial and full depth.



24" deep workspace with  
24" deep Infinity Side Desk Edge Screen (GXSU).



30" deep workspace with  
30" deep Infinity Side Desk Edge Screen (GXSU).



36" deep workspace with  
36" deep Infinity Side Desk Edge Screen (GXSU).



24" deep workspace with  
18" deep Infinity Side Desk Edge Screen (GXSU).



30" deep workspace with  
24" deep Infinity Side Desk Edge Screen (GXSU).



36" deep workspace with  
30" deep Infinity Side Desk Edge Screen (GXSU).

Infinity Desk Edge Screens offer an optional wire manager that accompanies the bracket connection

- The gap will always be 1/2"
- A continuous trough allows for cable management
- The trough can accommodate a Power Rod (YEPD) or Power Bar (YEPS). Available from Complements: *Teknion's Ergonomics & Accessories Program*

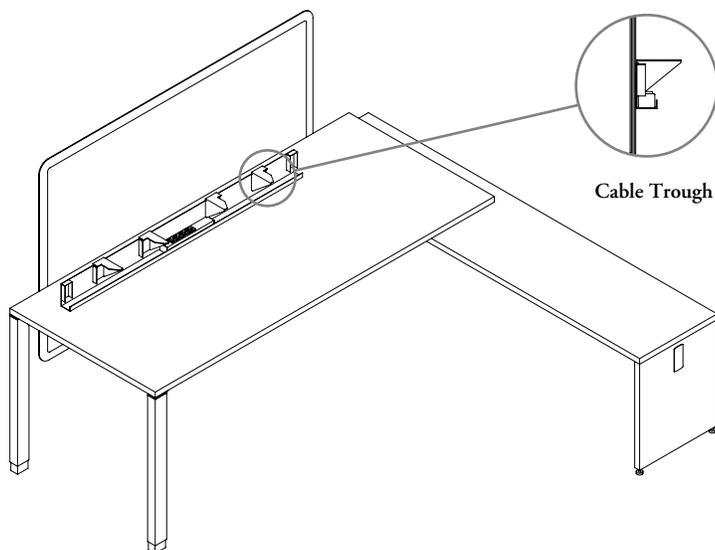

# planning with desk edge screens (continued)

## framed fabric screens

The following applications are available when planning with framed fabric screens.

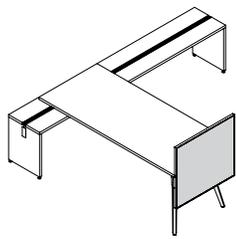

Side Desk Edge Screen

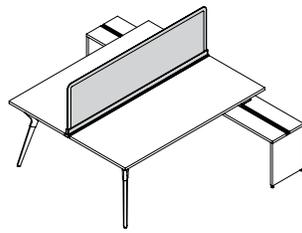

Accessory Beam Mount Screen

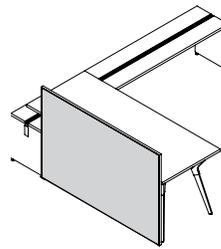

Desk Edge Floor Screen

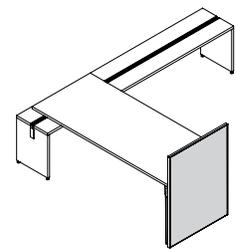

Side Desk Edge Floor Screen

Framed Fabric Screen widths are actual and will be same width as worksurface.



Framed Fabric Screens are always the width of the worksurface, there are no gaps. When planning in-line, no alignment clips are required. It will be a tight fit but not physically connected.

The screen mounts 1/2" from the worksurface.

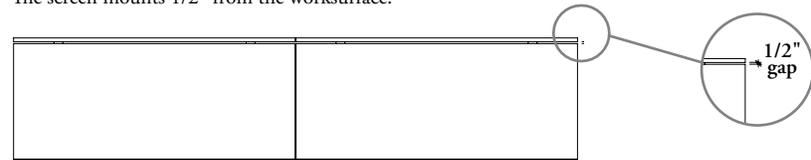

Framed Fabric Screens are physically connected at a corner. It is not a casual collection.

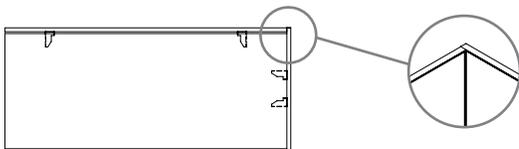

The brackets on framed fabric screens will always have a common bracket placement of 10 3/8" from either edge

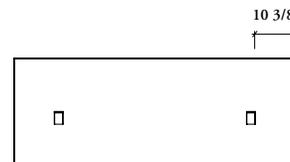

Framed Desk Edge Screens (GYSU) can be attached to worksurfaces in the following applications:

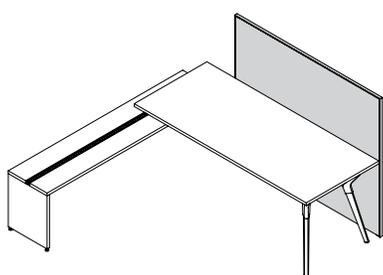

Worksurface with Stage Module or Credenza

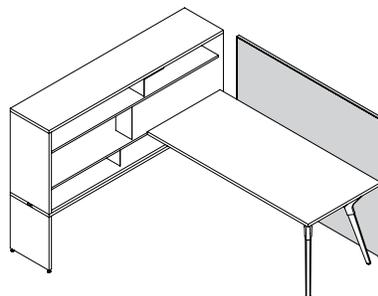

Worksurface with Hutch Stacker

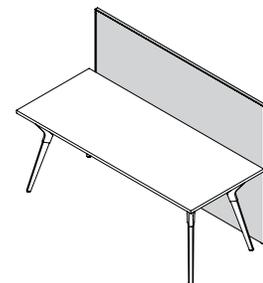

Freestanding Worksurface

## planning with desk edge screens (continued)

The following should be considered when planning with Framed Desk Edge Screens:

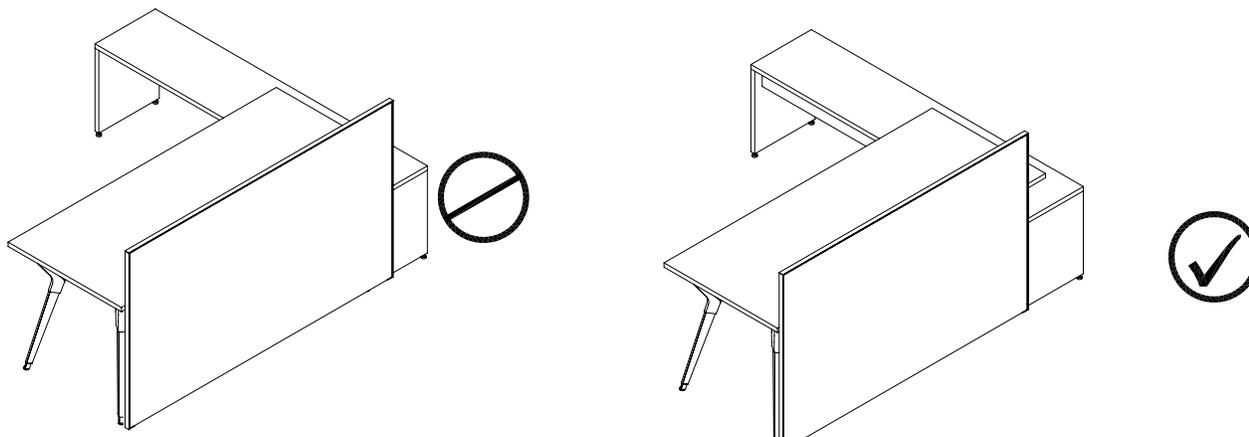

Perpendicular Worksurface (HTWP) with Framed Fabric Desk Edge Floor Screen (GYFU).

Two leg styles can be used with the Framed Side Desk Edge Screens:

- Y-Leg (HTWD) (shown)
- Interpret Leg (HTWN)

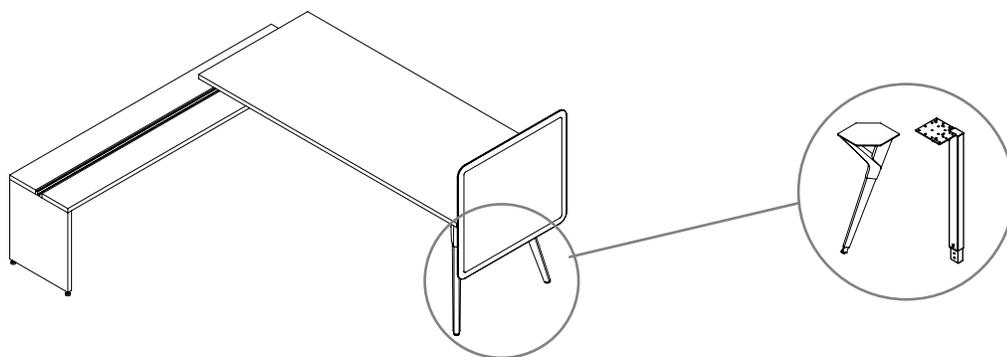

## desk edge floor screen basics

Desk Edge Floor Screens mount to worksurfaces and provide full-height privacy.

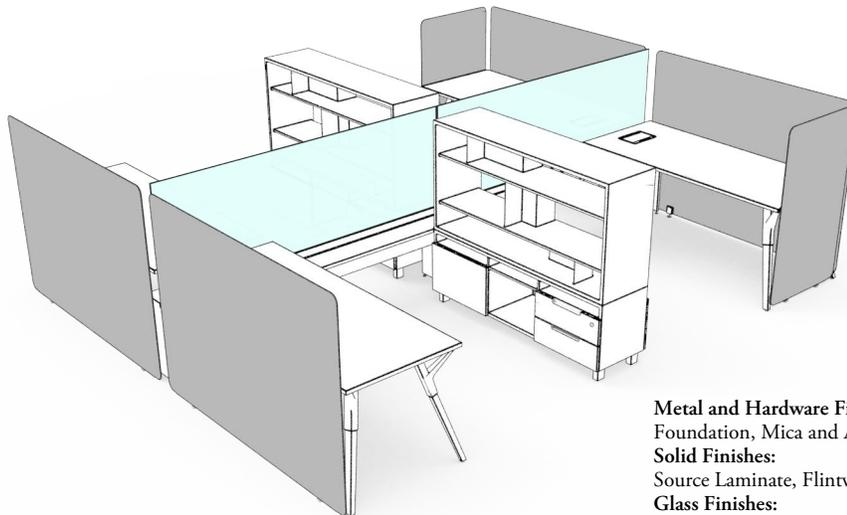

**Metal and Hardware Finishes:**  
Foundation, Mica and Accent colors  
**Solid Finishes:**  
Source Laminate, Flintwood and Natural Veneer  
**Glass Finishes:**  
Clear, Frost and Satin  
**Fabric Finishes:**  
All Teknion Standard Panel Fabrics

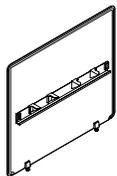

### Infinity Desk Edge Floor Screen (GXFU)

- Heights above worksurface:
  - 13" for a 42" high datum
  - 22" for a 51" high datum
- Modesty Base Heights: Floor Height (1")
- Widths: 36" - 70" in 1" increments



### Infinity Side Desk Edge Floor Screen (GXEU)

- Heights above worksurface:
  - 0" for a 29" high datum
  - 13" for a 42" high datum
  - 22" for a 51" high datum
- Modesty Base Heights:
  - Partial Modesty Height (23")
  - Modesty Height (15")
  - Elevated Height (6")
  - Floor Height (1")
- Widths: 30" - 66" in 6" increments
- Available with or without an Accessory Rail along the top



### Infinity Screen Alignment Clip (GXCC)

- Used to clip Infinity screens together in side-by-side applications

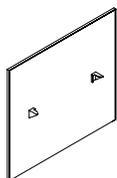

### Framed Fabric Desk Edge Floor Screen (GYFU)

- Heights above worksurface:
  - 13" for a 42" high datum
  - 22" for a 51" high datum
- Modesty Base Heights: Floor Height (1")
- Widths: 36" - 70" in 1" increments



### Framed Fabric Side Desk Edge Floor Screen (GYEU)

- Heights above worksurface:
  - 13" for a 42" high datum
  - 22" for a 51" high datum
- Modesty Base Heights: Floor Height (1")
- Widths: 36" - 70" in 1" increments
- Depths: 18" to 48" in 6" increments

# planning with desk edge floor screens

The following should be considered when planning with single-sided upStage Desk Edge Floor Screens.

When mounting a Desk Edge Floor Screen on a single sided upStage configuration, the screen must stop minimum 12" from the edge of Stage Module to avoid bracket interferences

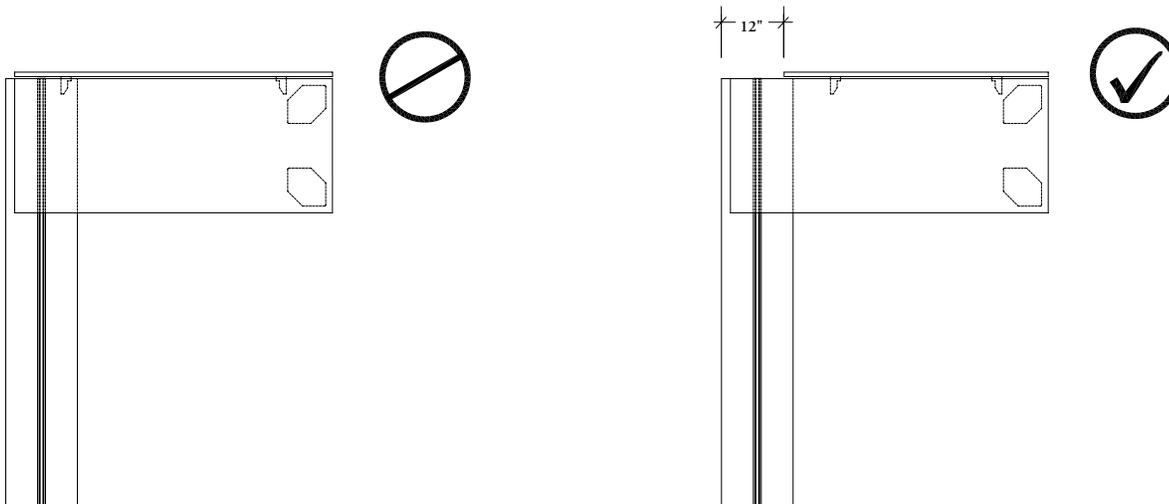

## desk edge screens with glass basics

Desk Edge Screens with Glass mount to worksurfaces on-module to provide privacy at 42", 51" and 57" heights.

### desk edge screens with glass

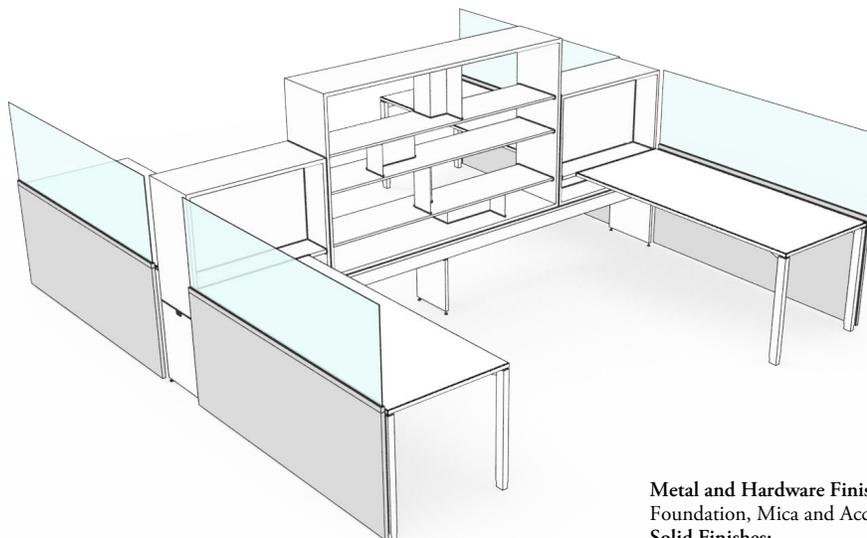

**Metal and Hardware Finishes:**  
Foundation, Mica and Accent colors  
**Solid Finishes:**  
Source Laminate, Flintwood and Natural Veneer  
(Horizontal Wood Grain)  
**Glass Finishes:**  
Clear, Frost and Satin

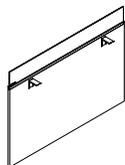

#### Desk Edge Screens with Glass (GVGU)

Mount to a worksurface to provide a solid modesty below and glass above at various heights.

- Widths: 46", 52", 58", 64", 70"
- Heights:
  - 29" Solid with 13" Glass to provide a 42"h datum
  - 42" Solid with 9" Glass to provide a 51"h datum
  - 29" Solid with 22" Glass to provide a 51"h datum
  - 42" Solid with 15" Glass to provide a 57"h datum
- Modesty Base Heights: Floor Height 1"



# planning with desk edge screens with glass

The following should be considered when planning with Desk Edge Screens with Glass.

## desk edge screens with glass

- Desk Edge Screens with Glass are available in three standard Teknion overall datum heights, 42", 51" and 57" high.

42" high datum

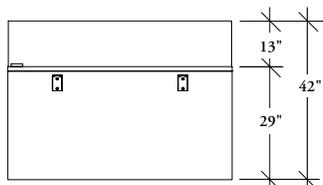

42" high Screen consists of a 29" high solid screen with 13" Glass above.

51" high datum

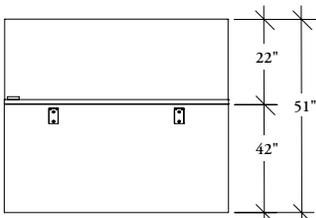

- The 51" high Screen is available in two options:
  - 42" high solid Screen with 9" Glass above
  - 29" high solid Screen with 22" Glass above

51" high datum

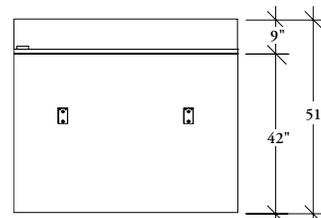

57" high datum

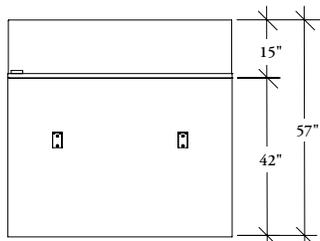

57" high Screen consists of a 42" high solid screen with 15" Glass above.

Desk Edge Screens with Glass can be attached to worksurfaces in the following applications.

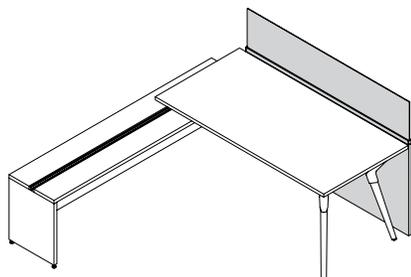

Worksurface with Stage Module or Credenza

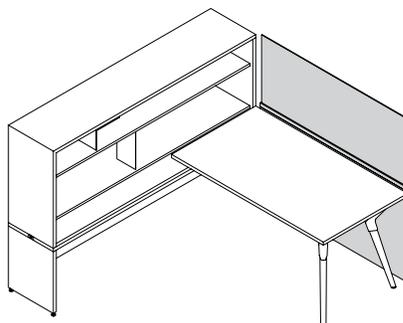

Worksurface with Hutch Stacker

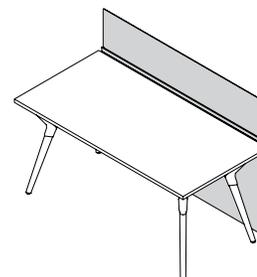

Freestanding Worksurface

# modesty screens basics

Modesty Screens mount below the worksurface to provide privacy.

## modesty screens

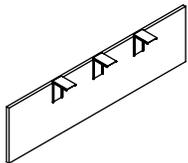
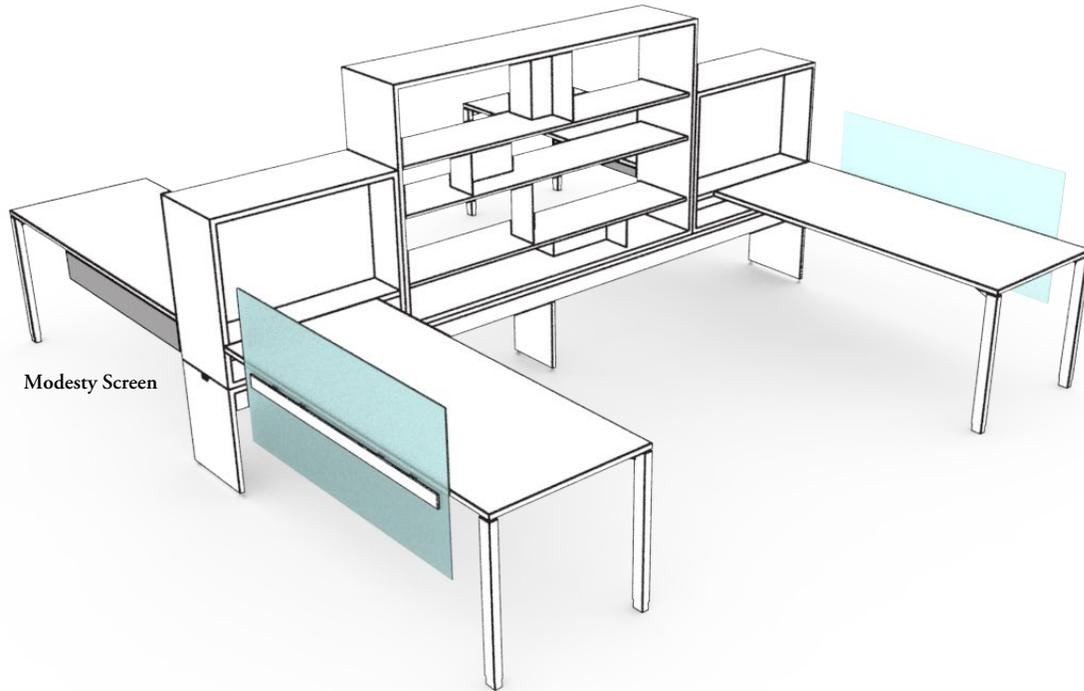

### Modesty Screen (HTNN)

- Modesty Height Below Worksurface: (13") for 29" high datum
- Widths: 24" - 54" in 6" increments
- Available in Solid only

Careful attention should be paid when planning Modesty Screens with the Y-Leg and Interpret Leg as brackets can interfere.

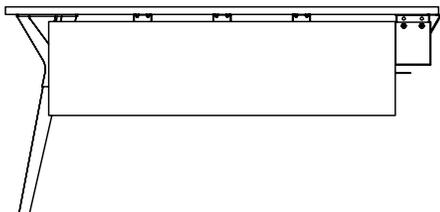

When specifying a Modesty Screen with the Y-leg it must be specified 22" narrower than the worksurface.

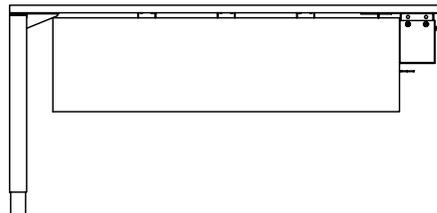

When specifying a Modesty Screen with the Interpret Leg it must be specified 16" narrower than the worksurface.

# solid lateral screen basics

Solid Lateral Screens mount perpendicular to the spine to provide space division.

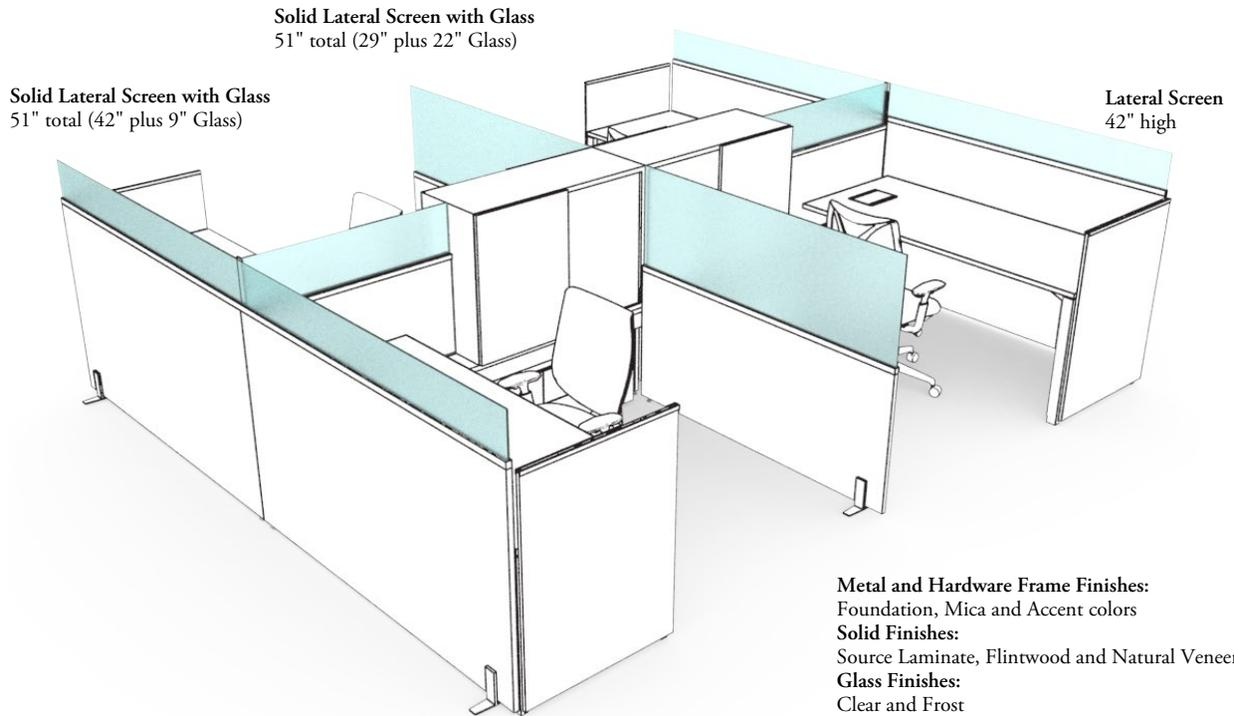

**Metal and Hardware Frame Finishes:**  
Foundation, Mica and Accent colors  
**Solid Finishes:**  
Source Laminate, Flintwood and Natural Veneer  
**Glass Finishes:**  
Clear and Frost  
\*Support Foot will match hardware color

- Options:
  - End Mounted Single
  - End Mounted Double
  - End Mounted Double (for HA module)
  - End Mounted Shared
  - End Mounted Shared (for HA module)
  - Flush Mid Gable
  - Flush End Gable
  - End Mounted Corner Connection
- Most screens are handed and are determined by the location of the bracket in relation to the screen
- All floor screen widths are actual
- Infeed Grommets **cannot** be accessed when End Mounted, Shared, Double and Single are used
- Power Pole or Exterior Base Feed **cannot** be used when Lateral Screens are covering both End Gables of a Stage

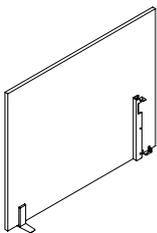

### Solid Lateral Floor Screen (HTNL)

- Heights: 42", 51" and 57"
- Depths: 24", 30", 36" and 42" - 84" in 1" increments

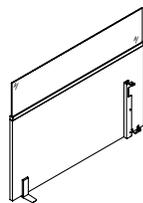

### Solid Lateral Screen with Glass (HTNA)

- Heights:
  - 42" total (29" plus 13" glass)
  - 51" total (42" plus 9" glass)
  - 51" total (29" plus 22" glass)
  - 57" total (42" plus 15" glass)
- Depths: 24" - 84" in 6" increments

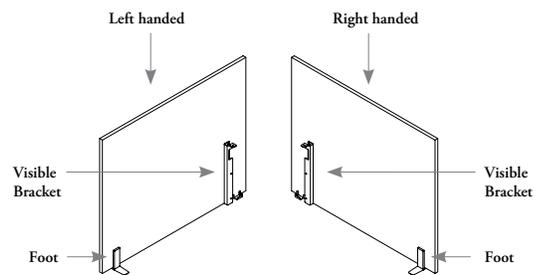

- The left handed orientation will have the visible mounting brackets on the right and the support foot (if required) will be on the left
- The right handed orientation will have the visible mounting brackets on the left and the support foot (if required) will be on the right

## planning with solid lateral screens

The following should be considered when planning with Solid Lateral Screens.

### solid lateral screens

When there is 36" of unsupported screen a Support Foot is required and will be included with screen.

The Lateral Screen can be mounted in nine locations:

#### End Mounted Corner Connection (handed)

- Mounts to the entire end of the Spine to provide Privacy in single sided applications
- Works in conjunction with HTNE Solid Corridor Screens and includes alignment pin hardware to ensure tight corners
- Widths: 24" - 84"
- To determine User Width, minus the full depth of the stage (16")

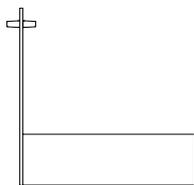

On widths 44" and above there will be a mandatory support foot

#### End Mounted Shared (not handed)

- Mounts on the outside of the stage to provide partial privacy on both sides
- Widths: 24" - 84"
- To determine User Width, use overall width of screen, minus the depth of the stage

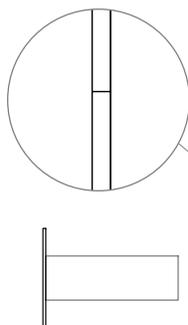

Will not have support foot

#### End Mounted Double (handed)

- Mounts to the midpoint of the outside of the stage to provide additional privacy
- Widths: 24" - 84"
- To determine User Width, use overall width of screen, minus half the depth of the stage (8")

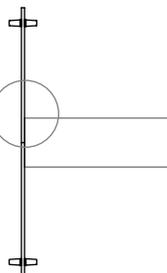

On widths 44" and above there will be a mandatory support foot

#### End Mounted Single (handed)

- Mounts to the entire end of the spine to provide privacy in single sided applications
- Widths: 24" - 84"
- To determine User Width, use overall width of screen, minus the full depth of the stage (16")

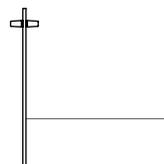

On widths 52" and above there will be a mandatory support foot

#### Flush Mid Gable (not handed)

- Mounts to the face of the stage to provide privacy between users
- Widths: 24" - 72"
- 73" - 84" is not available
- The User Width equals overall width of screen

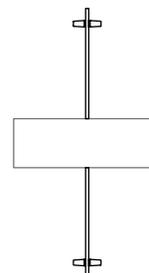

On widths 36" and above there will be a mandatory support foot

#### Flush End Gable (handed)

- Mounts to both faces of the stage to provide privacy between users
- Widths: 24" - 72"
- 73" - 84" is not available
- The User Width equals overall width of screen

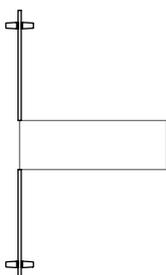

On widths 36" and above there will be a mandatory support foot

#### End Mounted Shared for HA Module (handed)

- Mounts on the outside of the stage to provide partial privacy on both sides
- Widths: 24" - 84"
- To determine User Width, use overall width of screen, minus the depth of the stage

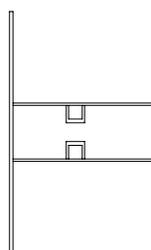

Will not have support foot

#### End Mounted Double for HA Module (handed)

- Mounts to the midpoint of the outside of the stage to provide additional privacy
- Widths: 24" - 84"
- To determine User Width, use overall width of screen, minus half the depth of the stage (8")



On widths 44" and above there will be a mandatory support foot

#### End Mounted Single for HA Module (handed)

- Mounts to the entire end of the spine to provide privacy in single sided applications
- Widths: 24" - 84"
- To determine User Width, use overall width of screen, minus the full depth of the stage (16")

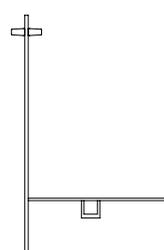

On widths 52" and above there will be a mandatory support foot

# planning with solid lateral screens (continued)

## solid lateral screens with glass

- Lateral Screens with Glass are available in two standard Teknion overall datum heights, 42", 51" and high.

42" Datum

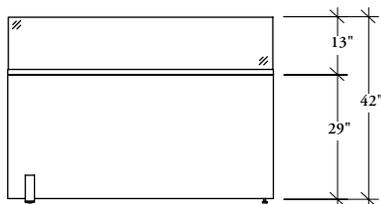

42" high Screen consists of a 29" high solid screen with 13" Glass above

51" Datum

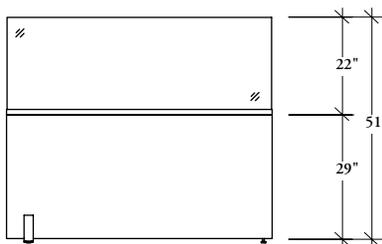

The 51" high Screen is available in two options:

- 29" high solid Screen with 22" Glass above
- 42" high solid Screen with 9" Glass above

51" Datum

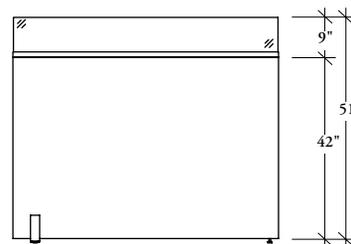

57" Datum

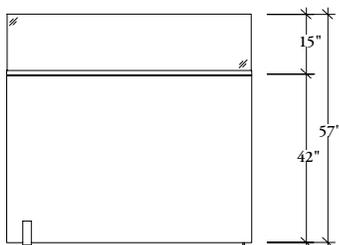

57" high Screen consists of a 42" high solid screen with 15" Glass above

## grain direction

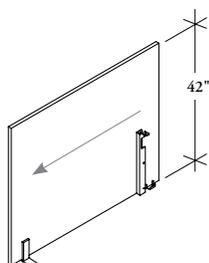

- For 42" high solid lateral screens with Source Laminate finishes the grain runs horizontal
- For Cathedral Flintwood and Natural Veneers the grain direction is from left to right from the user's perspective. From the visitor's perspective, outside the workstation, the grain direction is right to left

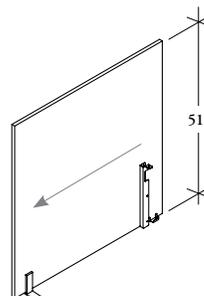

- For 51" and 57" high solid lateral screens with Source Laminate finishes the grain runs horizontal
- For Cathedral Flintwood and Natural Veneers the grain direction is from bottom to top from both the user's and visitor's perspective, inside and outside the workstation

## solid corridor screen basics

Corridor Screens attach to the Stage to provide space division in a single-sided application or along a corridor.

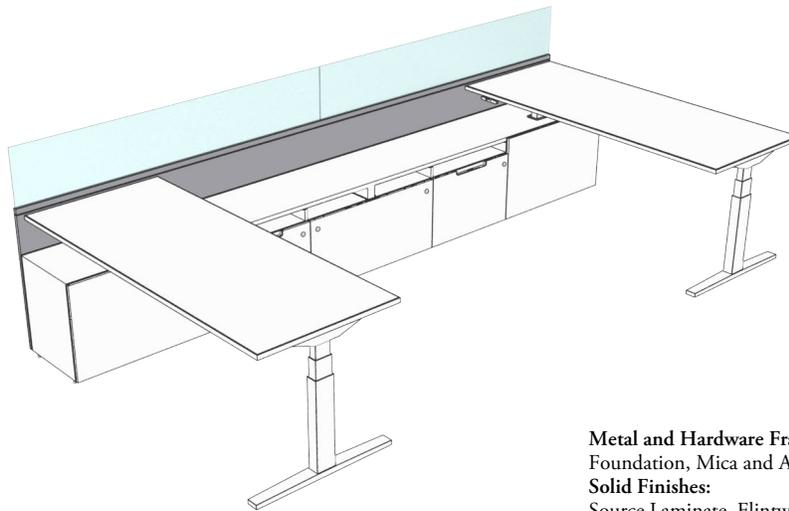

**Metal and Hardware Frame Finishes:**  
Foundation, Mica and Accent colors  
**Solid Finishes:**  
Source Laminate, Flintwood and Natural Veneer  
**Glass Finishes:**  
Clear and Frost  
\*Support Foot will match hardware color

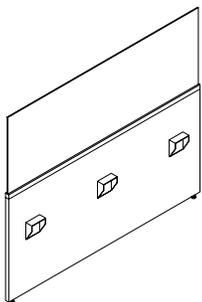

### Solid Corridor Screen with Glass (HTNE)

- Heights:
  - 42" total (29" plus 13" glass)
  - 51" total (42" plus 9" glass)
  - 51" total (29" plus 22" glass)
- Widths:
  - 42" high screens include widths 24" - 96" in 6" increments
  - 51" high screens include widths 24" - 84" in 6" increments
- All Solid Corridor Screen widths are actual

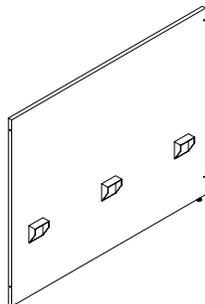

### Solid Corridor Screen (HTNC)

- Heights: 42" and 51" high
- Widths:
  - 42" high screens include widths 24" - 96" in 6" increments
  - 51" high screens include widths 24" - 84" in 6" increments
- All Solid Corridor Screen widths are actual

# planning with solid corridor screens

The following should be considered when planning with Solid Corridor Screens.

## solid corridor screens

When planning with solid corridor screens there are various ways to create privacy and one-sided workstations.

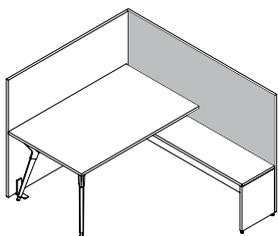

Corridor Screens can be used together with lateral screens for a continuous privacy solution.

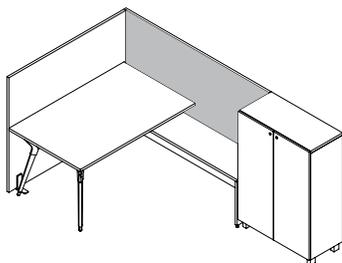

Corridor Screens can be combined with stage-mounted storage to completely cover one side of the stage.

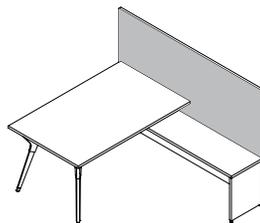

Corridor Screens can be used with single-sided worksurfaces to optimize the available space above the stage.

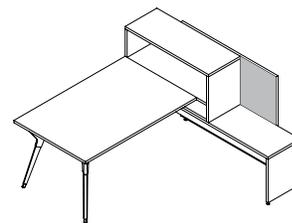

Corridor Screens can be casually overlapped with stage-mounted storage units to provide varying levels of privacy.

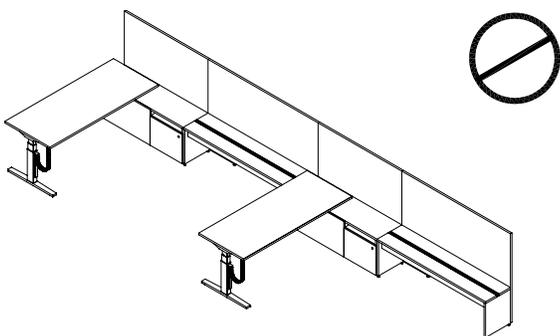

Corridor Screens cannot attach to Height-Adjustable credenzas.

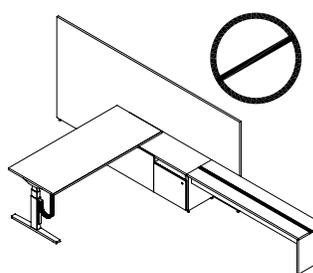

Corridor Screens are always planned against a stage.

## on and off module planning

- When planning with corridor screens on-module, or end-mounted off-module, the end gables will always be used as a primary vertical bracket attachment, whenever possible
- When planning with corridor screens off-module, at least one vertical attachment should always be provided either by a mid-gable or a credenza

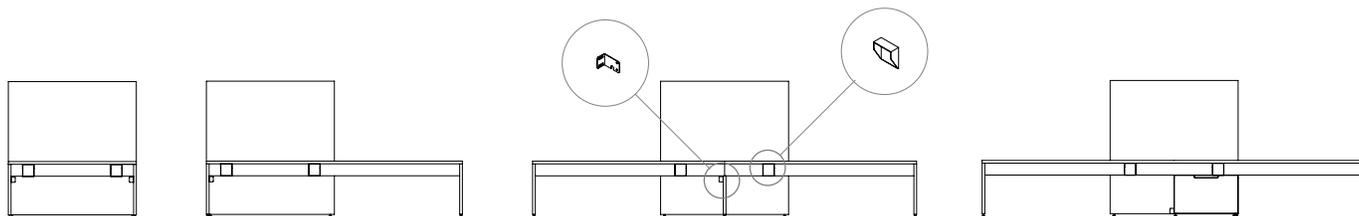

- For Solid Corridor Screens that are 24" to 48", there will be two horizontal brackets and one vertical bracket included

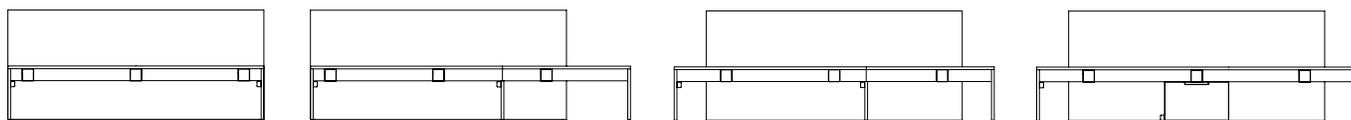

- For Solid Corridor Screens that are 54" to 96", there will be three horizontal brackets and two vertical bracket included

# planning with solid corridor screens (continued)

The following should be considered when planning with Solid Corridor Screens.

## without alignment, with in-line alignment and extended corner in-line alignment

The following shows the location of alignment options for self alignment and mix and match capabilities of the Solid Corridor Screens.

Solid Corridor Screens (HTNC) have the option of specifying Without Alignment, With In-Line Alignment, Extended Left Corner & In-Line Alignment and Extended Right Corner & In-Line Alignment. Solid Corridor Screens with Glass (HTNE) have the option of specifying Without Alignment and With In-Line Alignment. In order to connect Solid Corridor Screen (HTNC) with the Solid Lateral Screen (HTNL), End Mounted Corner Connection (EC) must be specified.

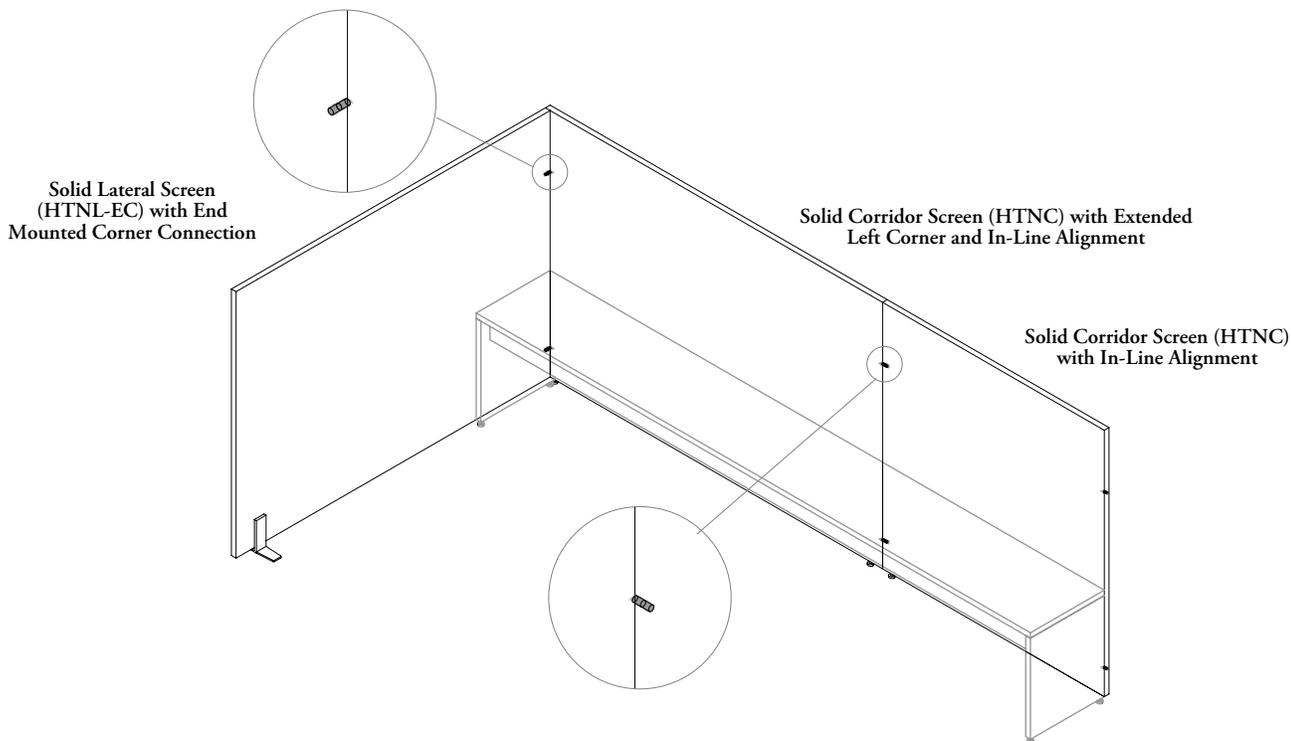

Alignment options for Solid Corridor Screen (HTNC)

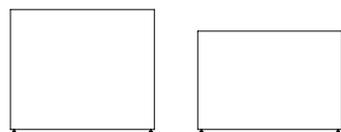

Without alignment

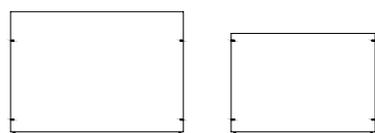

With In-Line alignment

Alignment options for Solid Corridor Screen with Glass (HTNE)

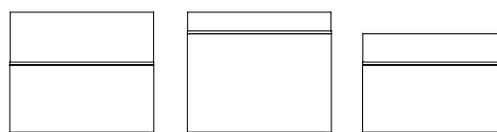

Without alignment

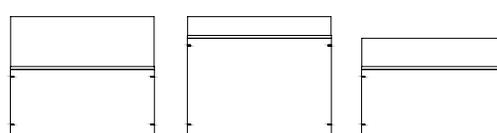

With In-Line alignment

Extended Left/Right Corner & In-Line Alignment

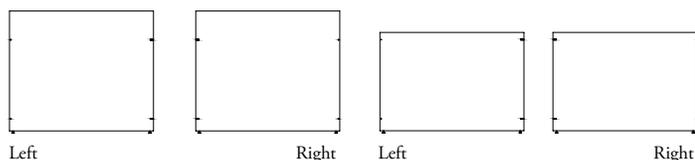

Left Right Left Right



# planning with solid corridor screens (continued)

## In-Line Alignment

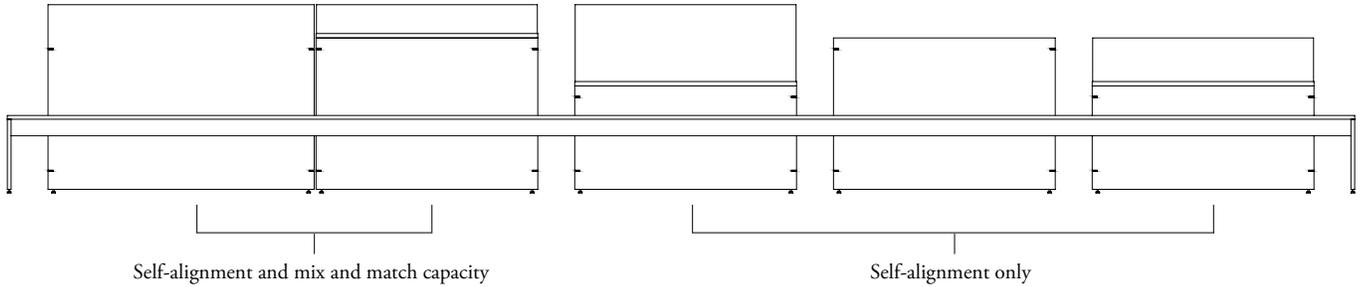

## solid corridor screens with glass

Corridor Screens with Glass are available in two standard Teknion overall datum heights, 42" and 51" high.

42" Datum

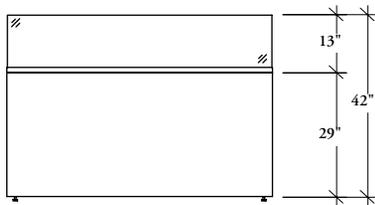

42" high Screen consists of a 29" high solid screen with 13" Glass above

51" Datum

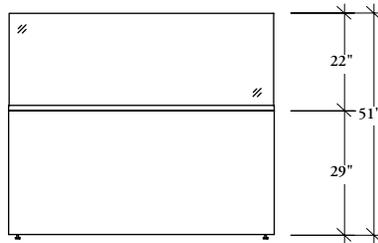

The 51" high Screen is available in two options:  
 - 29" high solid Screen with 22" Glass above  
 - 42" high solid Screen with 9" Glass above

51" Datum

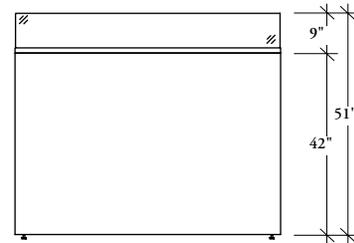

## grain direction

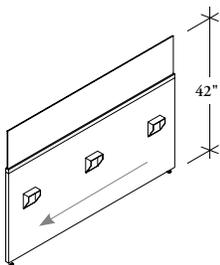

- For 42" (24"-96" wide) high solid corridor screens with Source Laminate finishes the grain runs horizontal
- For Cathedral Flintwood and Natural Veneers the grain direction is from left to right from the user's perspective. From the visitor's perspective, outside the workstation, the grain direction is right to left

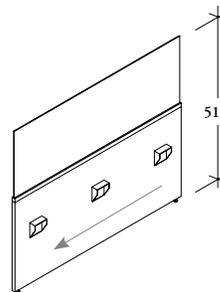

- For 51" (24"-84" wide) high solid corridor screens with Source Laminate finishes the grain runs horizontal
- For Cathedral Flintwood and Natural Veneers the grain direction is from bottom to top from both the user's and visitor's perspective, inside and outside the workstation

## lateral screen basics

Lateral Screens attach to the worksurface to provide lateral space division.

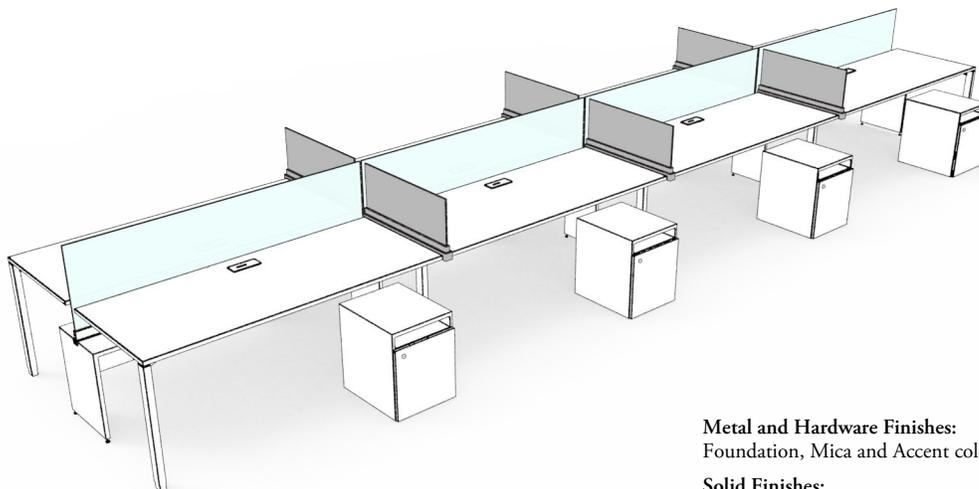

- A screen with straight/curved profile which provides privacy along with lateral space division
- Heights:
  - 13" for a 42" datum
  - 22" for a 51" datum
  - 28" for a 57" datum
- Depths: 23", 29" and 35"

**Metal and Hardware Finishes:**  
Foundation, Mica and Accent colors

**Solid Finishes:**  
Source Laminate, Flintwood and Natural Veneer

**Glass Finishes:**  
Clear, Frost and Satin

**Fabric Finishes:**  
All Teknion Standard Panel Fabrics

**Felt Finishes:**  
Strata, Pewter, Lunar and Warm Ash

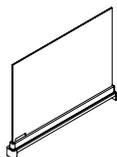

6mm Glass Lateral Screen (GNGU)

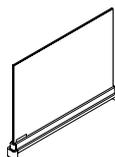

10mm Glass Lateral Screen (GNTU)

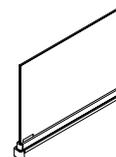

Writable Glass Lateral (GNWU)

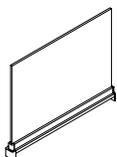

Solid Lateral Screen (GNSU)

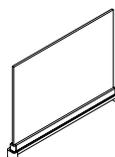

Writable Laminate Lateral Screen (GNLU)

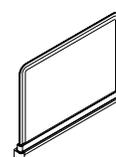

Infinity Lateral Screen (GNXU)

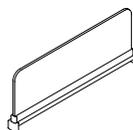

Smooth Felt Lateral Screen (GNZU)

- Available 13" and 22" high only

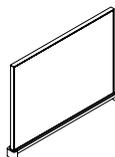

Framed Fabric Lateral Screen (GNYU)



Metal Lateral Screen (GNMU)

- Available 13" and 22" high only

# functional screen basics

upStage offers one framed spine screen option; the Functional Screen. The panel like structure with fascias provide privacy and functionality.

## functional screen

The Functional Screen provides additional stability and can be used with Fabric, Whiteboard as well as Accessory Fascias and Glass Add-ons up to 51" high datum height. Accessory Fascia is only available 13" high to provide a total of 42" high when use with a Glass Add-On.

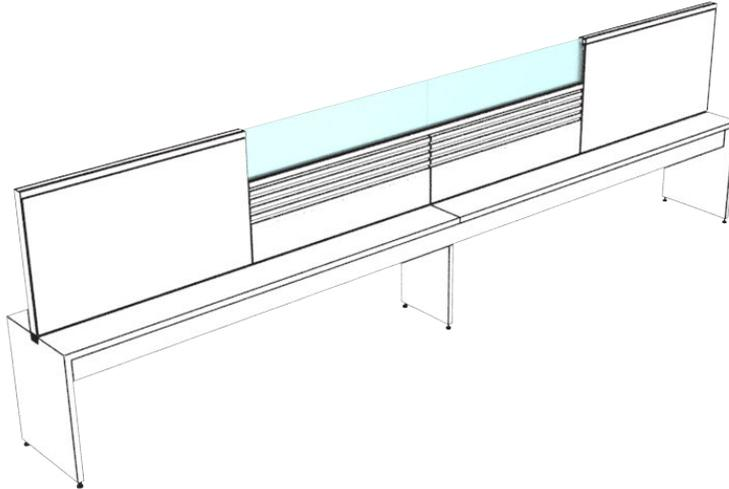

**Functional screens add functionality to a workstation.**

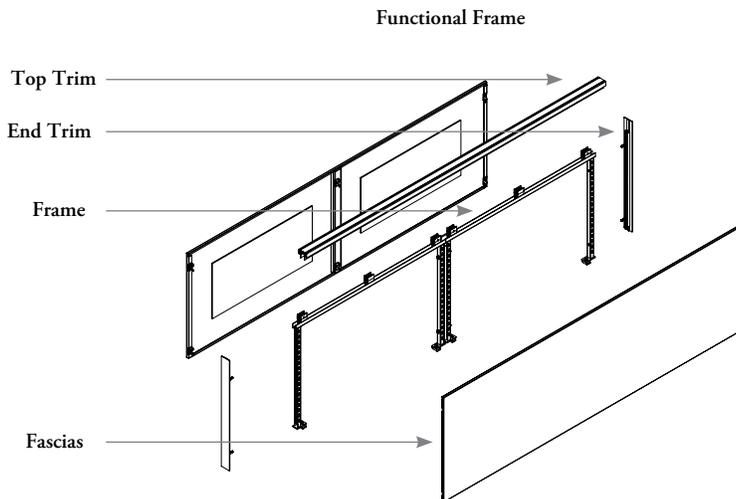

Functional Screens may be specified 13", 21" and 30" high. The 13" high Functional Screen is optimized to be used with the Glass Add-On Screen.



### Functional Screen Frame (HTCF)

- Mounts to the Accessory Beam and consists of a frame with vertical posts and a top rail. Frames over 48" wide will consist of two segments for added stability
- Heights: 13", 21" and 30"
- Widths: 24" - 96" in 6" increments
- Supports the Glass Add-On Screen
- Mounted on- or off-module



### Fascia Post Kit (HTCK)

- Required to provide additional support to the Functional Screen Frame when Accessory Fascias (HTCA) are used
- The kit mounts vertically inside of the frame and its required for all fascia sizes
- Heights: 13" and 21"

## functional screen basics (continued)

Functional Spine Screen Frames require Top Trim, End Trim, Intermediate Trim, Screen Connectors and Fascias to complete the screen.



### Top Trim (HTCT)

- Used on a Functional Screen when no Glass Add-On is required
- Widths: 24" - 96" in 6" increments
- Finishes: Foundation, Mica and Accent colors
- Can span more than one frame



### Top Trim for Glass Add-On (HTCG)

- Finishes the top of Functional Screen when a Glass Add-On is used
- Widths: 24" - 96" in 6" increments
- Finishes: Foundation, Mica and Accent colors
- Includes clips
- Can span more than one frame



### End Trim (HTCE)

- Finishes the end of a Functional Screen
- Heights: 13", 21" and 30"
- Finishes: Foundation, Mica and Accent colors

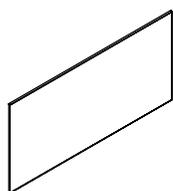

### Fabric Fascia (HTCR)

- Provides a tackable surface
- Heights: 13", 21" and 30"
- Widths: 24", 27", 30", 33", 36", 39", 42", 45", 48", 54" and 60"
- Finishes: all Standard Teknion Panel Fabrics

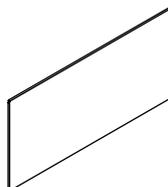

### Whiteboard Fascia (HTCW)

- Provides a Whiteboard surface
- Heights: 13", 21" and 30"
- Widths: 24", 27", 30", 33", 36", 39", 42", 45", 48", 54", 60", 66" and 72"

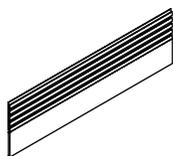

### Accessory Fascia (HTCA)

- Provides an Accessory Rail for mounting accessories
- Additional Fascia Post Kits (HTCK) are required for stability of this screen and are not included with the screen
- Available 13" high only and when used with an 8" Glass Add-On Screen provides a 42" high datum Height
- Widths: 24" - 96" in 6" increments
- Finishes: Foundation, Mica and Accent colors

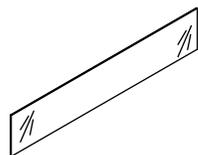

### Glass Add-On Screen (HTCL)

- Heights:
  - 8" and 9" (8" high attaches to a 13" functional screen for a 42" datum height
  - 9" high attaches to a 21" functional screen for 51" a datum height)
- Widths: 24" - 96" in 6" increments
- Screen finishes: Clear and Frosted Glass



### Screen Connector (HTCC)

- Required to connect adjoining frames
- Heights: 13", 21" and 30"

# planning with functional screens

The following should be considered when planning with Functional Spine Screens.

## functional spine screens

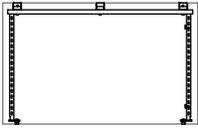

Frame widths 24" – 48" consist of two vertical posts and a top frame, they can accommodate one Fascia on each side of the frame.

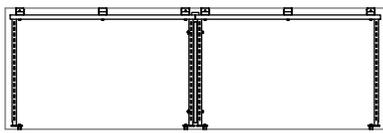

Frame widths 54" – 96" consist of four vertical posts and can accommodate one or two Fascias on each side of the frame.



Fascias can be specified to span over the entire width of the Functional Screen, or two Fascias can be specified at half the width each and do **not** need to be the same finish.

Side 1



Side 2



Fascias do not need to be the same on both sides of a frame, two Fascias can be specified on one side of the frame and a single fascia on the opposite side.



Only one or two Fascias of equal size can be used on a frame. Three Fascias **cannot** span on one frame.

# planning with functional screens (continued)

Screen connectors are required between adjoining screens

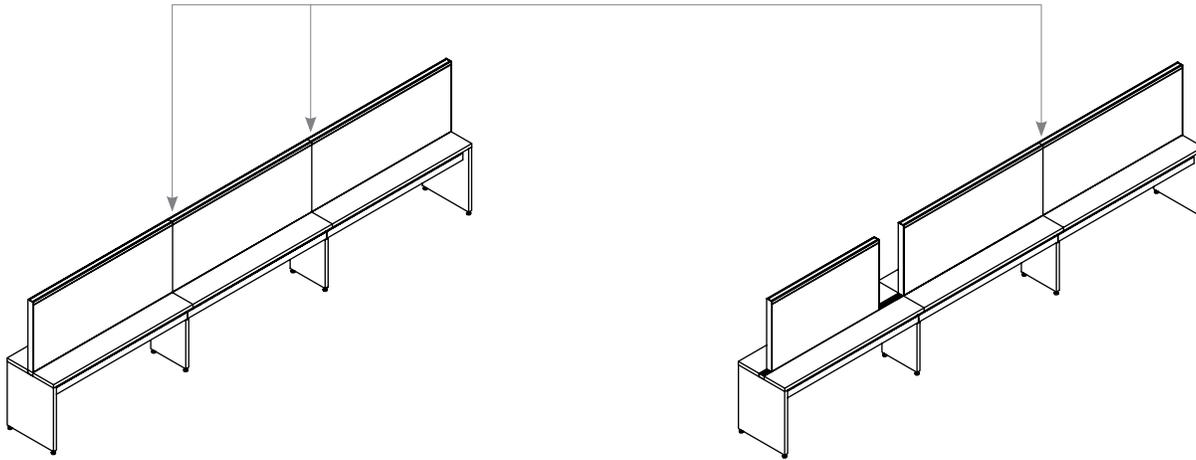

End Trims are required on all exposed Ends.

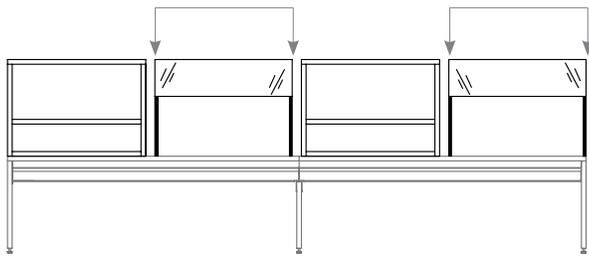

Four End Trims are required

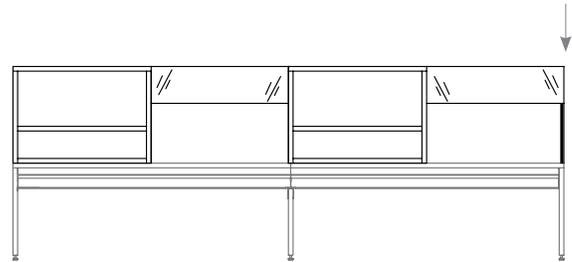

One End Trim is required

When planning with Casual Screens beside Functional Screens, the End Cap on the Casual Screen must be removed providing space for the End Trim of the Spine Screen.

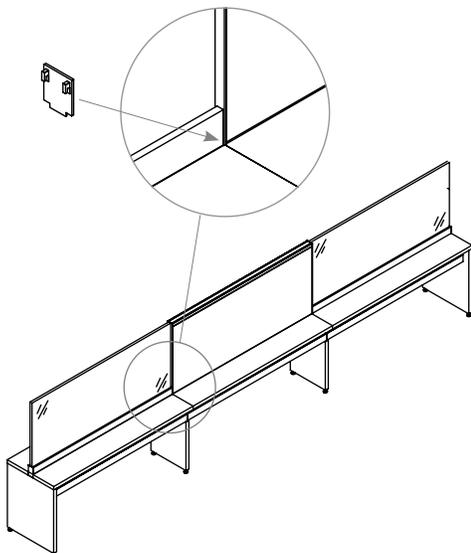

# planning with functional screens (continued)

## top trim-glass

The Top Trim for Glass Add-On (HTCG) must be used when Add-On Glass Screens (HTCL) are specified.

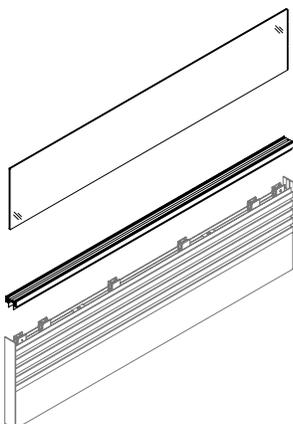

## datum heights

The 8" high Glass Add-On is used with the 13" high functional frame to reach a 42" high datum. The 9" high Glass Add-On is used with the 21" high functional frame to reach a 51" high datum.

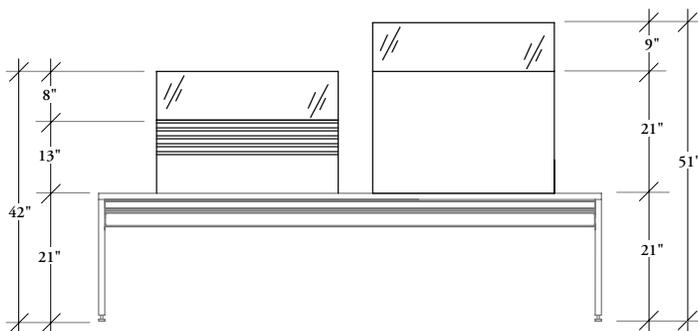

hutch stackers &  
accessories



# hutch stackers & accessories

UNDERSTANDING HUTCH STACKERS . . . . .	146
HUTCH STACKERS BASICS . . . . .	148
PLANNING WITH HUTCH STACKERS . . . . .	149
HUTCH STACKERS WITH SLIDING DOOR BASICS . . . . .	150
PLANNING WITH HUTCH STACKERS WITH SLIDING DOOR OVERHEAD . . . . .	151
PLANNING WITH HUTCH STACKERS & HUTCH STACKERS WITH OVERHEAD . . . . .	152
HUTCH STACKER FINISHES . . . . .	156
HUTCH STACKERS WITH SLIDING DOOR OVERHEAD FINISHES . . . . .	157
HUTCH ACCESSORY BASICS . . . . .	158
HUTCH FASCIA ADD-ON BASICS . . . . .	159
PLANNING WITH FASCIA ADD-ONS . . . . .	160
ELEVATED HUTCH BASICS . . . . .	162
PLANNING WITH ELEVATED HUTCHES . . . . .	163
ELEVATED HUTCH & LATERAL TOWER FINISHES . . . . .	164

# understanding hutch stackers

**Hutch Stackers are used on Stages and Credenzas to provide functional space division and various levels of privacy. All are complete with a lower cubby and options for upper storage.**

Hutches are available in three styles:

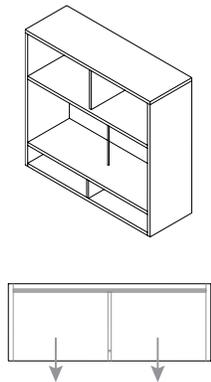

**Single Hutches** face one direction with a screening element aligned to the back of the cabinet. The integrated cubby and optional overhead extends the full depth of the cabinet.

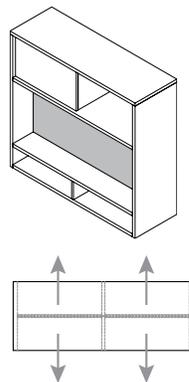

**Shared Hutches** face in two directions with a screening element along the center line of the cabinet, so is optimized for flexible planning. The integrated lower cubbies are half depth and the optional overhead creates a handed “S” style split.

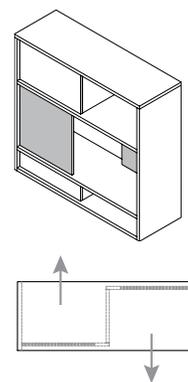

**Aperture Style Hutches** have the screening element split, with a 6” gap between them. Optimized for asymmetric planning of workspaces, it provides a shared open space between neighbors, while providing privacy for heads-down work. Both lower cubbies and optional overheads have the “S” style split (always handed).

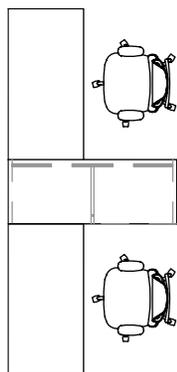

**Single Style Hutches** allow for head down space and privacy between users. Provides full cabinet depth of storage for one user in single sided applications or allows for a second user to access the backside for additional functionality.

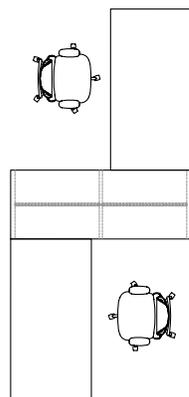

**Shared Style Hutches** allow for head down space and privacy between users. The center screen allows workspaces to be planned either symmetric or asymmetric with some area for small items.

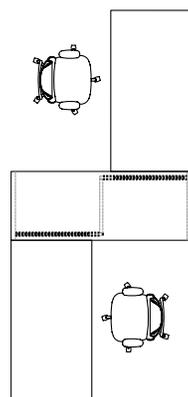

**Aperture Style Hutches** Worksurfaces mount to the backside of each screen to provide heads down privacy when required, additional space for small items and the ability to collaborate when desired.

# understanding hutch stackers (continued)

Six levels of privacy are available:

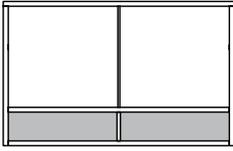

**Open Through Hutch**

Hutch area is open, however both upper and lower Cubby area closed.

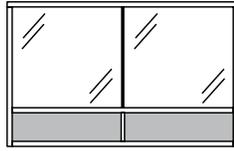

**Glass Back Hutch**

Provides translucency between users in Hutch area.

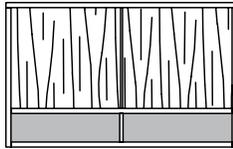

**Solid Back Hutch**

Provides solid privacy for users in Hutch and Cubby area.

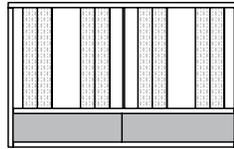

**Perforated Hutch**

Provides privacy in Hutch area while allowing light to pass through the Hutch.

# hutch stackers basics

upStage hutches mount to a stage to provide various levels of casual privacy and functionality.

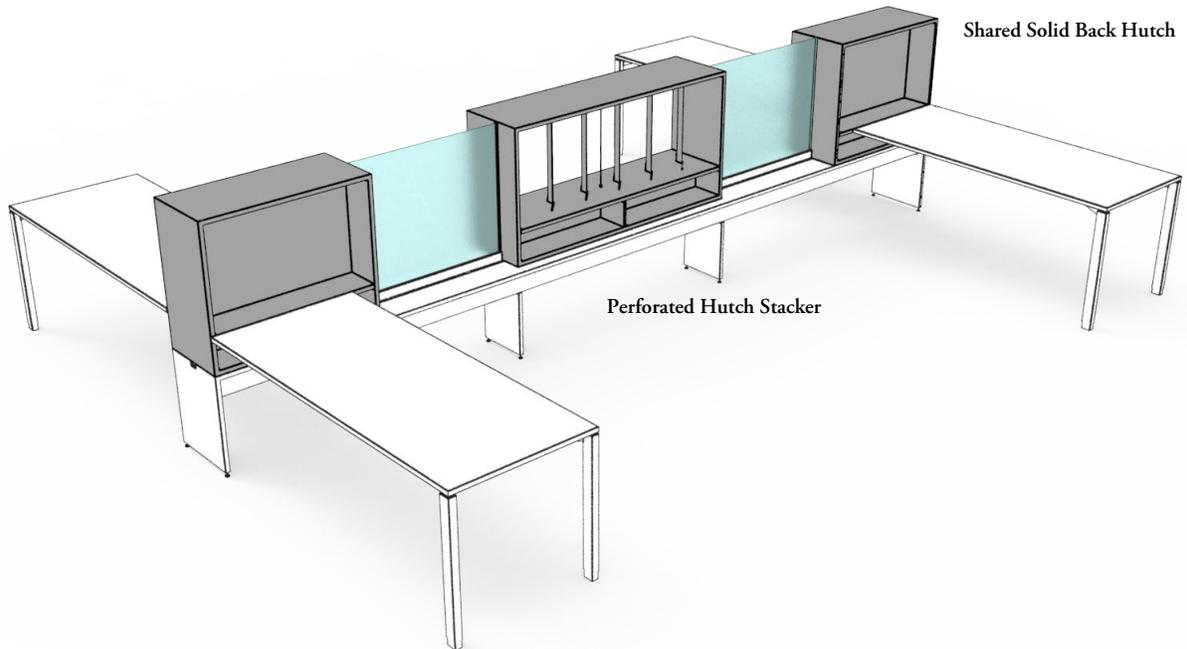

- All hutches include a lower cubby at desk height to allow worksurfaces to be mounted horizontally
- Heights: 21", 30" and 45"
  - The 30" and 45"h are available with optional top cubbies
- Configurations:
  - Single, the hutch and cubbies will be open from one side only
  - Shared (the hutch and cubby section is split so that each side is half the depth of the hutch)
    - Aperture (the hutch and cubby section is split so that each side is half the width of the hutch but the full depth)
- The cubby section will always be solid regardless of the style

- Widths:
  - 30" - 72" in 6" increments for single applications
  - 42" - 72" in 6" increments for shared or aperture applications
- Styles:
  - Open
  - Solid back
  - Glass back
  - Perforated metal
- In single and shared hutches 42"w or wider, the lower and upper cubbies will have a mid gable for support
- An interior chrome rod is required for support on hutches 42"w or wider (except in shared applications)

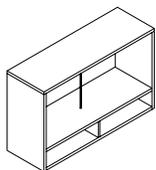

**Open Through Hutch Stacker (HTSHN)**

- The hutch is open through so only the cubbies are considered single sided

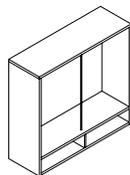

**Solid Back Hutch Stacker (HTSHS)**

- The hutch has a solid back
- Accommodates a hutch fascia add-on (HTAH)

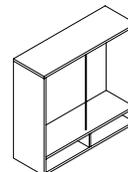

**Glass Back Hutch Stacker (HTSHG)**

- The hutch has a glass back

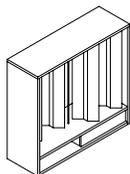

**Perforated Hutch Stacker (HTSHP)**

- The hutch has angled perforated blades to provide partial privacy
- Not available single sided

# planning with hutch stackers

The following chart outlines the configurations available when planning with upStage Hutch Stackers.

		Open		Solid Back		Glass Back		Perforated	
		HTSHN	with cubbies	HTSHS	with cubbies	HTSHG	with cubbies	HTSHP	with cubbies
21" High	Single		×		×		×	×	×
	Shared		×		×		×		×
	Aperture		×	×	×	×	×	×	×
30" High	Single							×	×
	Shared								
	Aperture								
45" High	Single	×						×	×
	Shared	×							
	Aperture	×							

## hutch stackers with sliding door basics

upStage hutches mount to a stage to provide various levels of casual privacy and functionality and additional closed overhead storage.

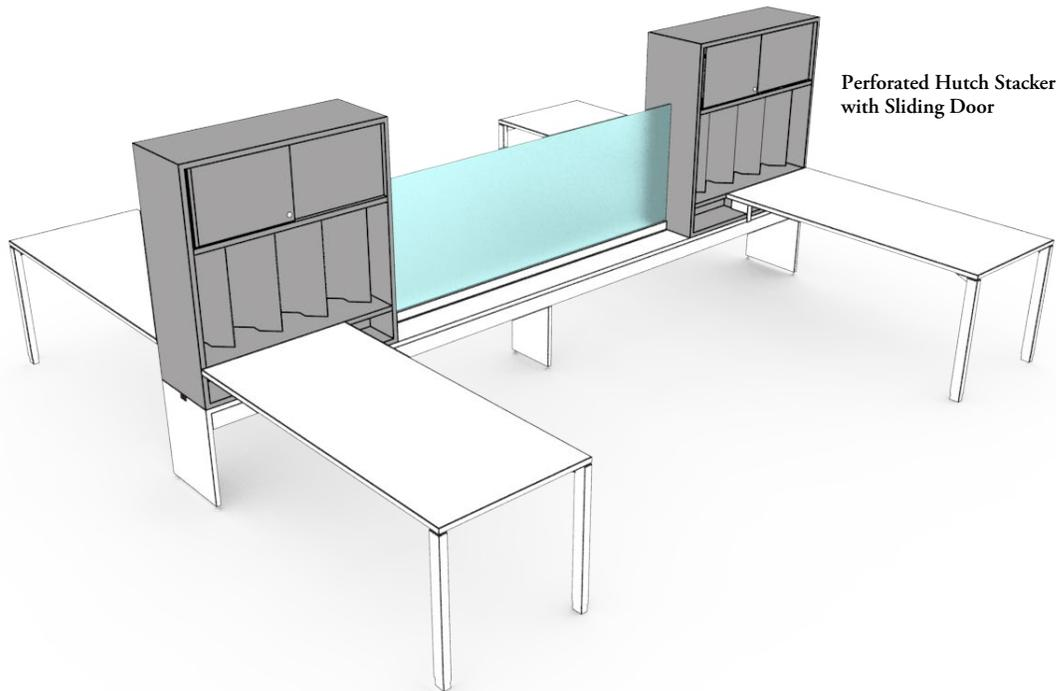

Perforated Hutch Stacker with Sliding Door

- All hutches with sliding doors include a lower cubby at desk height to allow worksurfaces to be mounted horizontally
- Heights: 45" h
- Configurations:
  - Single, the hutch, cubbies and overhead will be open from one side only
  - Shared (the hutch and lower cubbies are split so that each side is half the depth of the hutch, the overhead is split so that each side is half the width of the hutch but the full depth)
  - Aperture (the hutch, cubbies and overhead is split so that each side is half the width of the hutch but the full depth)
- The cubby section will always be solid regardless of the style
- Widths:
  - 30" - 72" in 6" increments for single applications
  - 42" - 72" in 6" increments for shared or aperture applications
- Styles:
  - Open
  - Solid back
  - Glass back
  - Perforated metal
- In single and shared hutches 42" w or wider, the lower cubbies will have a mid gable for support
- An interior chrome rod is required for support on hutches 42" w. or wider (except in shared applications)

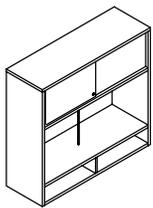

Open Through Hutch Stacker with Sliding Door Overhead (HTSHNK)

- The hutch is open through so only the cubbies are considered single sided

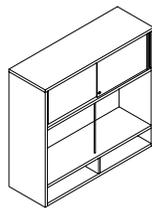

Solid Back Hutch Stacker with Sliding Door Overhead (HTSHSK)

- The hutch has a solid back
- Accommodates a hutch fascia add-on (HTAH)

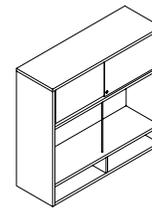

Glass Back Hutch Stacker with Sliding Door Overhead (HTSHGK)

- The hutch has a glass back

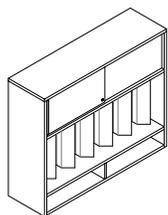

Perforated Hutch Stacker with Sliding Door Overhead (HTSHPK)

- The hutch has angled perforated blades to provide partial privacy
- Not available single sided

# planning with hutch stackers with sliding door overhead

The following chart outlines the configurations available when planning with upStage Hutch Stackers with Sliding Door Overhead.

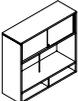
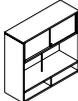
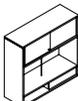
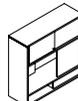
		Open	Solid Back	Glass Back	Perforated
		HTSHNK	HTSHSK	HTSHGK	HTSHPK
45" HIGH	Single				×
	Shared				
	Aperture				

# planning with hutch stackers & hutch stackers with overhead

The following should be considered when planning with Hutch Stackers & Hutch Stackers with Overheads.

- upStage Hutches match Teknion standard 42", 51" and 66" datum heights
- Hutches can stack onto the following:
  - 21h" stages
  - 21h." elevated credenzas
  - 15"h. stage credenzas with a 6" Stage Spacer Block (HTAS)

## datum heights

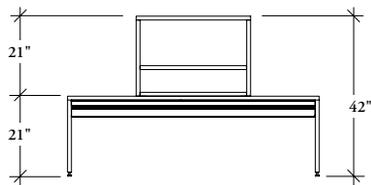

Hutch on Stage  
(42"h shown)

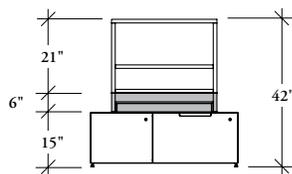

Hutch on Stage Credenza  
with spacer block  
(42"h shown)

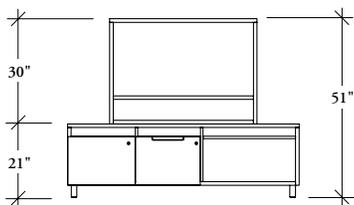

Hutch on Elevated Credenza  
(51"h shown)

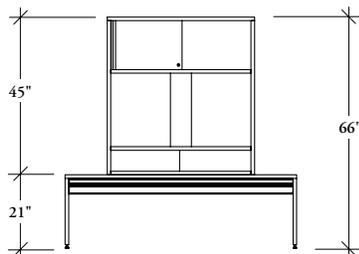

Hutch on Stage  
(66"h shown)

The top cubby height will vary depending on the height of the hutch.

30" high Hutch with  
Top Cubby

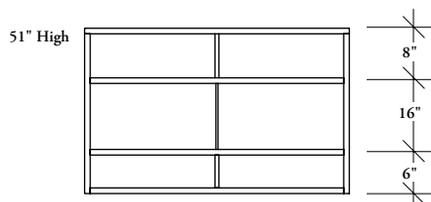

The 8" high Top Cubby accommodates casual piling.

45" high Hutch with  
Top Cubby

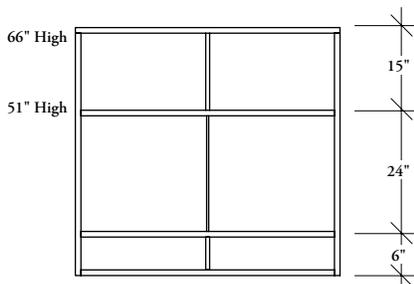

The 15" high Top Cubby accommodates standard binder storage.

45" Hutch with  
Sliding Door Overhead

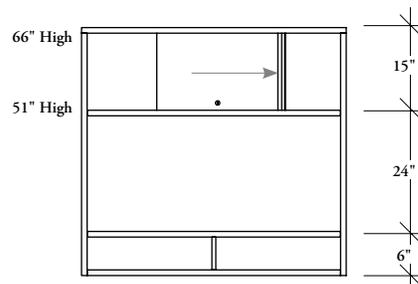

The 15" high Sliding Door Overhead accommodates standard binder storage.



# planning with hutch stackers & hutch stackers with overhead (continued)

## support

A chrome plated rod is integrated into hutches over 42" w excluding the following:

- Shared Solid and Glass Hutches
- Shared Solid and Glass Aperture Hutches

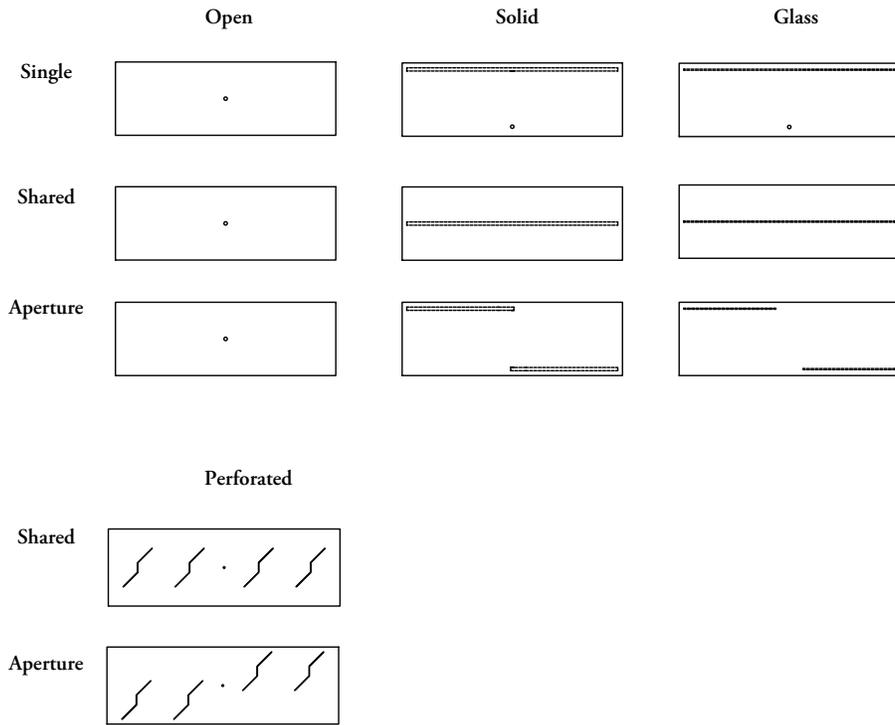

## handedness

Singled Sided Hutches are not handed aperture hutch handedness is determined by the location of the open space in both the upper and lower cubbies.

Shared Hutch handedness is determined by the location of the open space in both the upper and lower cubbies.

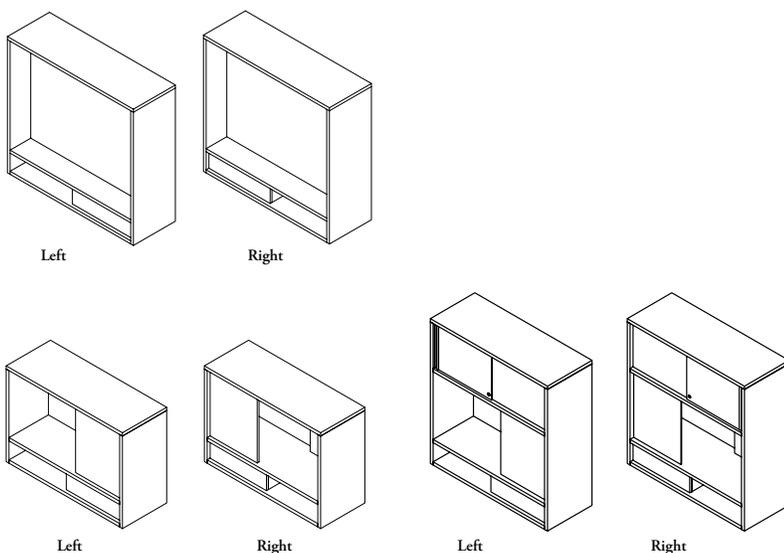

# planning with hutch stackers & hutch stackers with overhead (continued)

Perforated Hutches are handed to provide various degrees of privacy between users. The user can either look into the dividers or through the dividers.

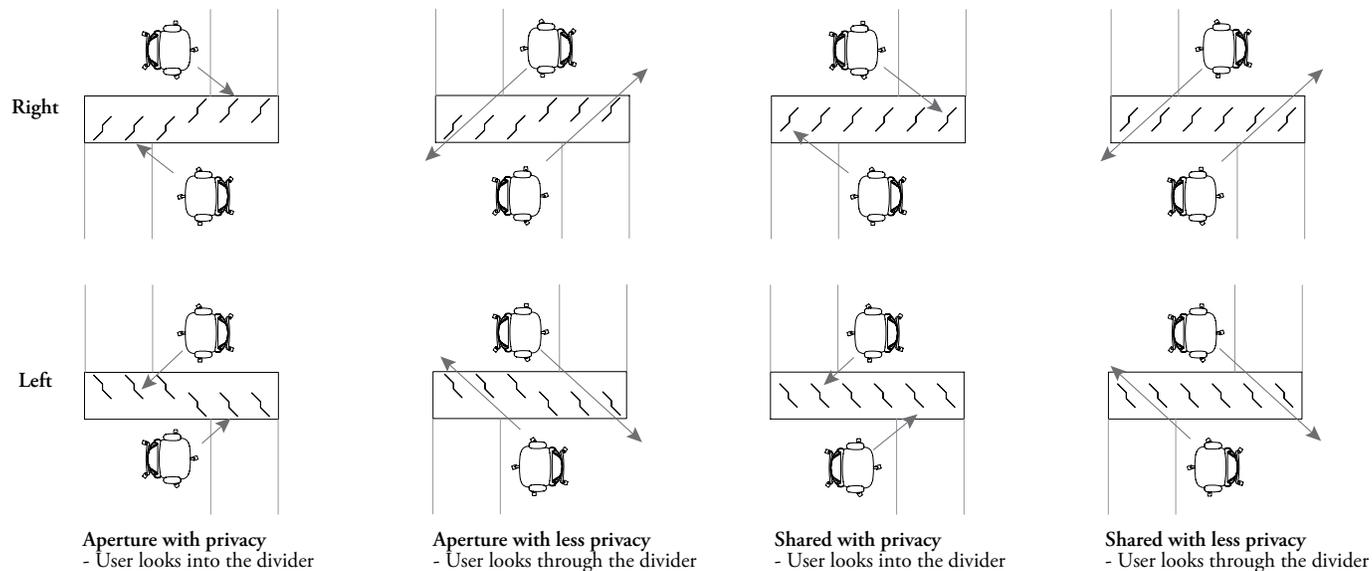

The spacing between the perforated blades depends on the width of the hutch.

## Perforated Metal Shared Hutch

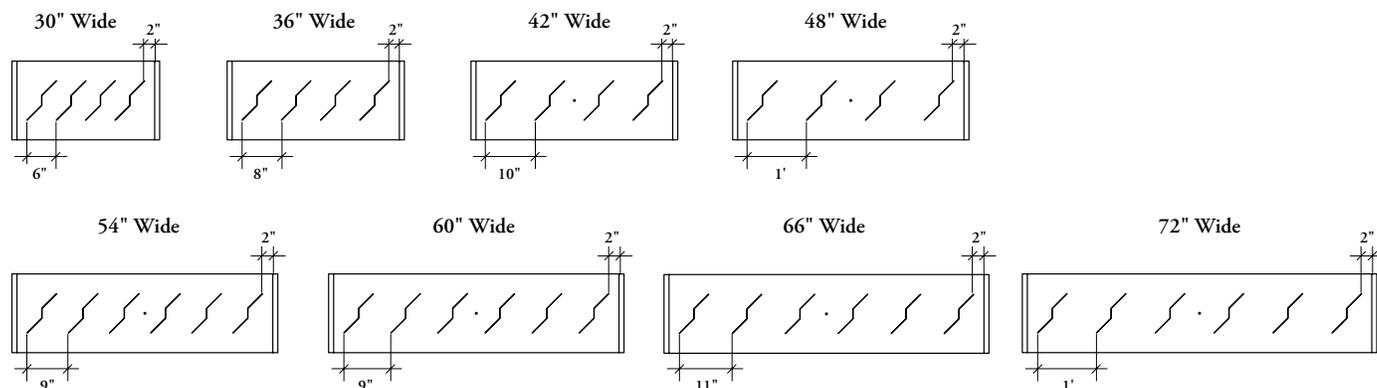

## Perforated Metal Aperture Hutch

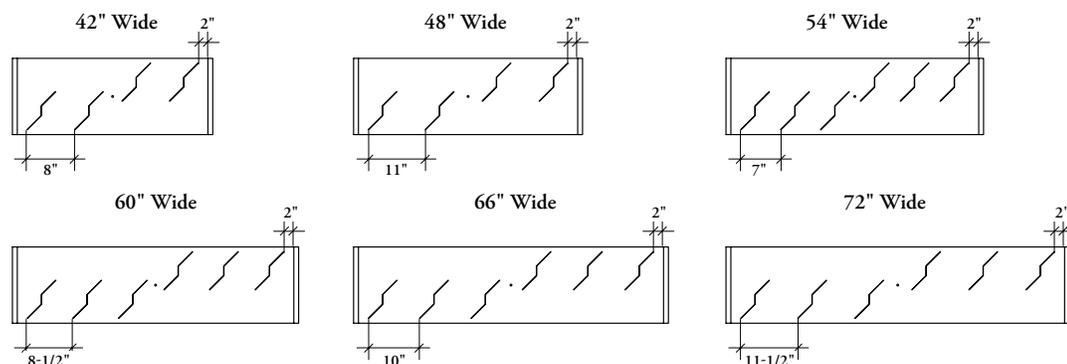

# planning with hutch stackers & hutch stackers with overhead (continued)

## aperture hutches

- Hutches are designed to provide privacy for the user
  - The worksurface should be mounted against the solid side of the hutch
  - Planning against the open side will cause bracket interference

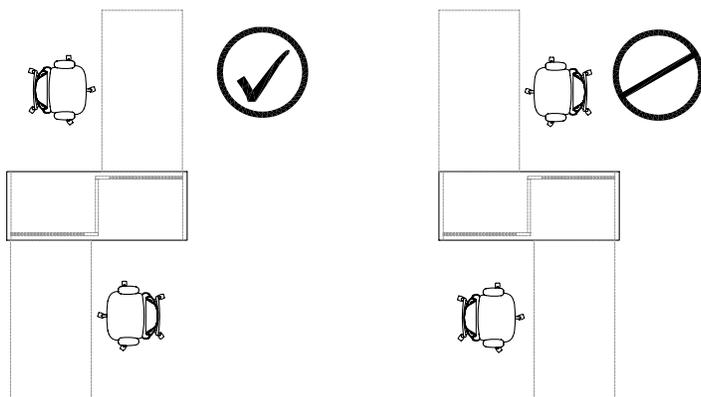

## additional support

- The following 45" high hutches (66"h overall datum height) without overheads or top cubbies require additional support for stability
  - Open
  - Perforated
- The support must be provided by an adjacent hutch 30" or higher
- The two hutches must be fastened to each other on site

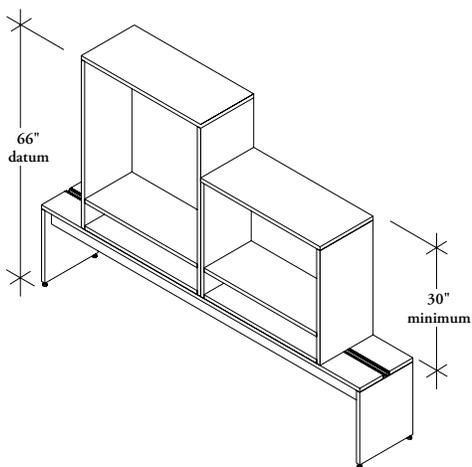

## semi-suspended worksurfaces and hutches

- Cubbies have a shelf at 29" high which has two uses
  - Perpendicular worksurfaces mount to it
  - It provides a secondary worksurface
  - If used in this application it is recommended that both surfaces be specified in the same finish

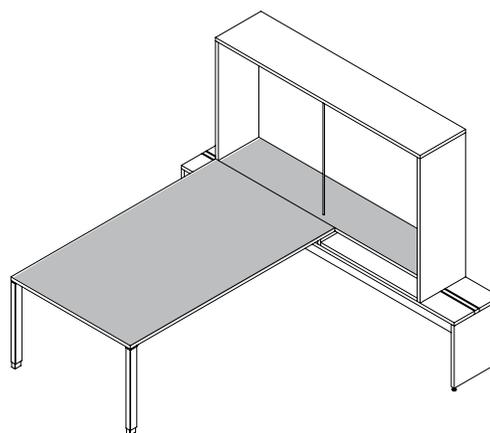

## hutch stacker finishes

upStage offers an extensive finish offering. The following outlines the finish protocol for Hutch Stackers.

For all Hutches without Sliding Door Overhead (Open Through Hutch Stacker **HTSHN**, Solid Back Hutch Stacker **HTSHS**, Glass Back Hutch Stacker **HTSHG**, Perforated Hutch Stacker **HTSHP**)

- Two Finish Zones
  - Case
  - Secondary which has three options
    - A - Shelves Only
    - B - Backs & Interior Dividers
    - C - Shelves & Interior Dividers & Back

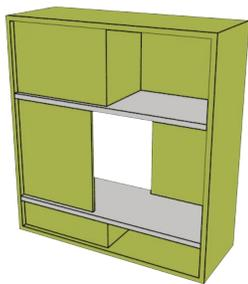

A



B

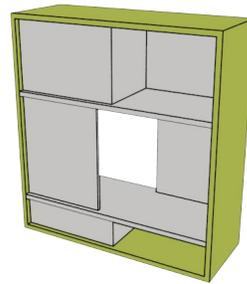

C

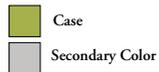

Case Finish	Secondary Finish
Flintwood	Flintwood
Natural Veneer	Natural Veneer
Source Laminate	Source Laminate

- Glass Back Options:
  - Clear
  - Frosted
- Perforated Metal Paint Options:
  - Foundation
  - Mica
  - Accent

# hutch stackers with sliding door overhead finishes

upStage offers an extensive finish offering. The following outlines the finish protocol for Hutch Stackers with Overheads.

For Hutch Stackers with Sliding Door Overhead (Open Through Hutch Stacker with Sliding Door Overhead **HTSHNK**, Solid Back Hutch Stacker with Sliding Door Overhead **HTSHSK**, Glass Back Hutch Stacker with Sliding Door Overhead **HTSHGK**, Perforated Hutch Stacker with Sliding Overhead **HTSHPK**)

- Three Finish Zones
  - Case, includes the outer walls and any surfaces not included in the secondary or front finish
  - Secondary finish, shelves only
  - Front, sliding doors

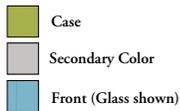
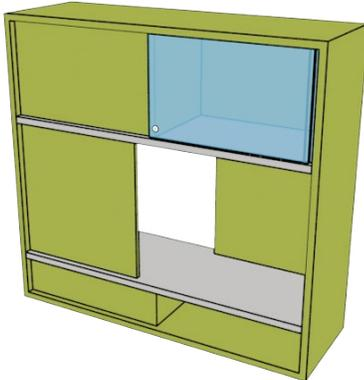

Case Finish	Secondary Finish	Front Finish
Flintwood	Flintwood	Flintwood Clear Glass Frosted Glass Back-Painted Glass
Natural Veneer	Natural Veneer	Natural Veneer Clear Glass Frosted Glass Back-Painted Glass
Source Laminate	Source Laminate	Source Laminate Flintwood Clear Glass Frosted Glass Back-Painted Glass

• **Hutch Glass Back Options:**

- Clear
- Frosted

• **Perforated Metal Paint Options:**

- Foundation
- Mica
- Accent

• **Sliding Door Handle:**

- Foundation
- Mica

\***Sliding Door Handle Finish:**

Foundation, Mica

# hutch accessory basics

Hutch Accessories are available to add functionality to upStage Hutches.

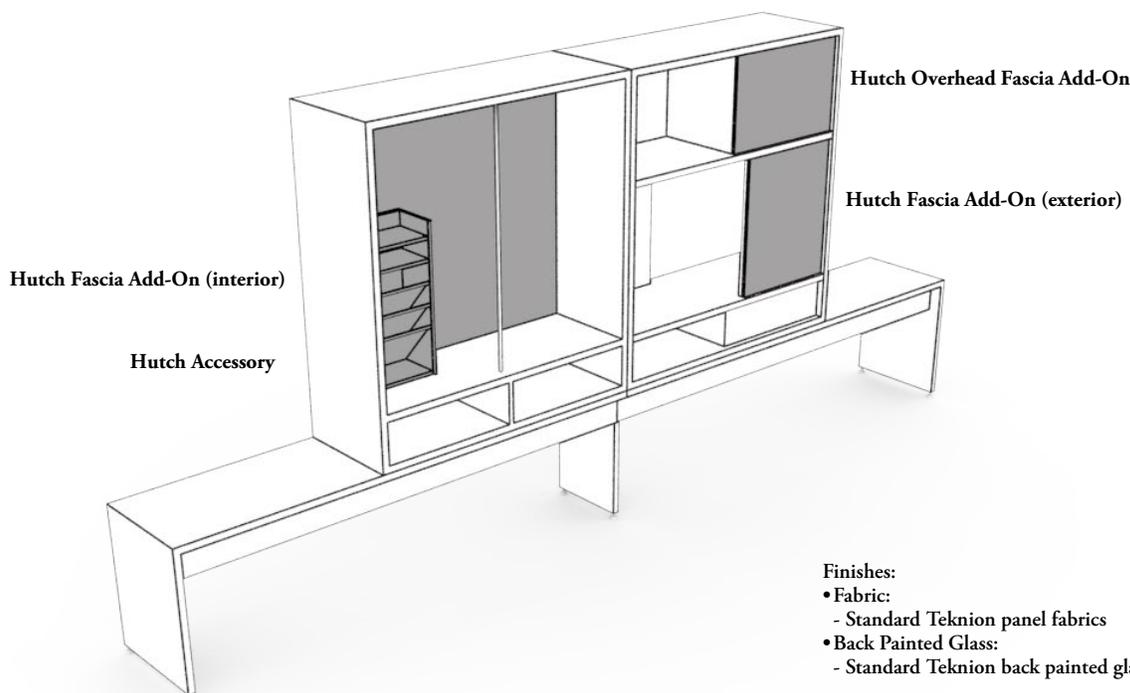

- Finishes:**
- **Fabric:**
    - Standard Teknion panel fabrics
  - **Back Painted Glass:**
    - Standard Teknion back painted glass finishes

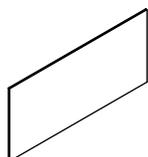

### Hutch Fascia Add-On (HTAH)

- Heights: 21", 30" and 45"
  - Heights are nominal and match the size of the hutch it is being mounted to
- Widths: 30" - 72" in 6" increments
- Applications:
  - Single
  - Single with overhead/cubby
  - Aperture
  - Aperture with overhead/cubby
  - Shared
  - Shared with overhead/cubby
- Interior and exterior options for shared applications

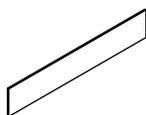

### Hutch Overhead Fascia Add-On (HTAV)

- Mounts to the back of an overhead/cubby
- Heights: 30" and 45"
  - Heights are nominal and match the size of the hutch it is being mounted to
- Widths: 30" - 72" in 6" increments
- Applications:
  - Single
  - Shard
  - Aperture

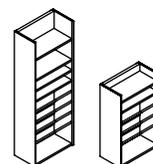

### Hutch Accessory (HTHA)

- Adds casual file storage to a hutch with and without overhead/cubbies
- Width: 12"
- Heights are nominal to match the height of the opening in the hutch
  - 21" High (actual 12"h)
    - Used with a 21"h hutch without an overhead/cubby
    - Used with a 30"h hutch with an overhead/cubby
  - 30" High (actual 21"h)
    - Used with a 30"h hutch without an overhead/cubby
    - Used with a 45"h. hutch with an overhead/cubby
  - 36" High (actual 36"h)
    - Used with a 45"h hutch without an overhead/cubby
- The back is unfinished, placing it against glass is not recommended unless it is planned back to back

# hutch fascia add-on basics

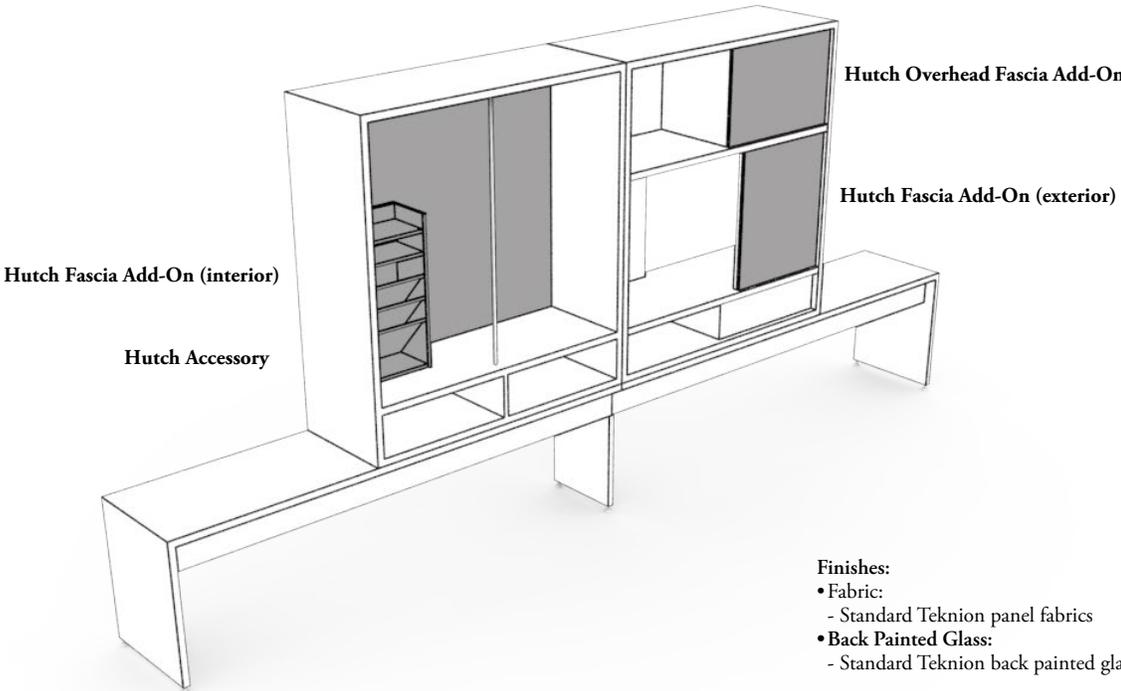

• Fascias are applied to hutches with solid backs

## planning with fascia add-ons

The following should be considered when planning with Hutch Fascia Add-Ons.

Fascia sizes are nominal and match the size of the hutch that they are being mounted to.

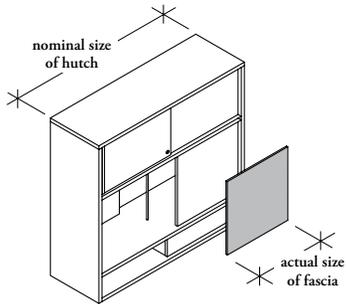

### applications

- Fascias are available for:
  - Interior and exterior applications
  - Single and shared applications

#### Hutch Fascia Add-On

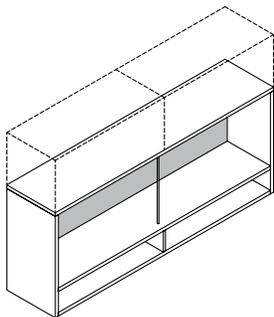

Single Application, Interior

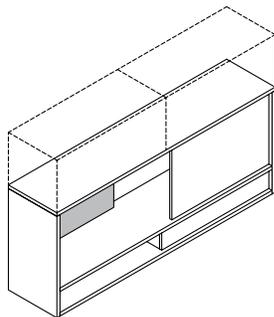

Shared Application, Interior

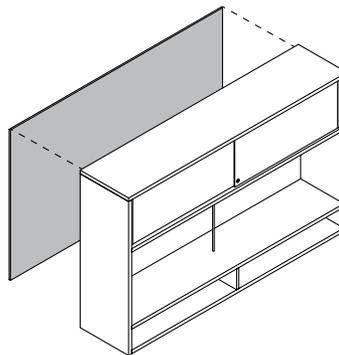

Single Application, Exterior

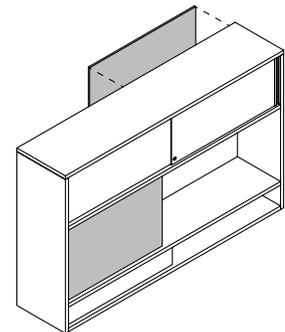

Shared Application, Exterior

#### Hutch Overhead Fascia Add-On

- When a fascia is required on an overhead, it must be specified separately
- It is available for single and shared applications

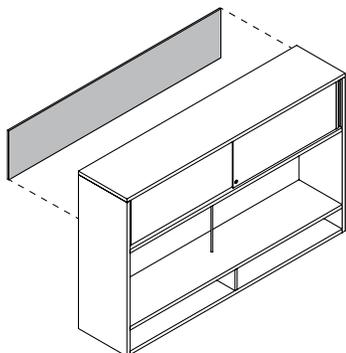

Single Application

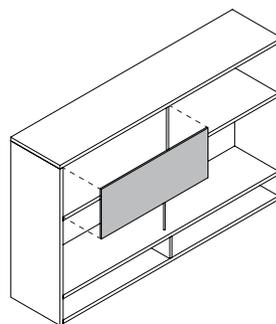

Shared Application



# planning with fascia add-ons (continued)

When planning with hutches with overheads the fascias are applied as follows:

- The exterior fascia spans the full height
- The interior fascia spans the height from the hutch shelf to the underside of the overhead
- Fascias do not span over the exterior or interior of a cubby

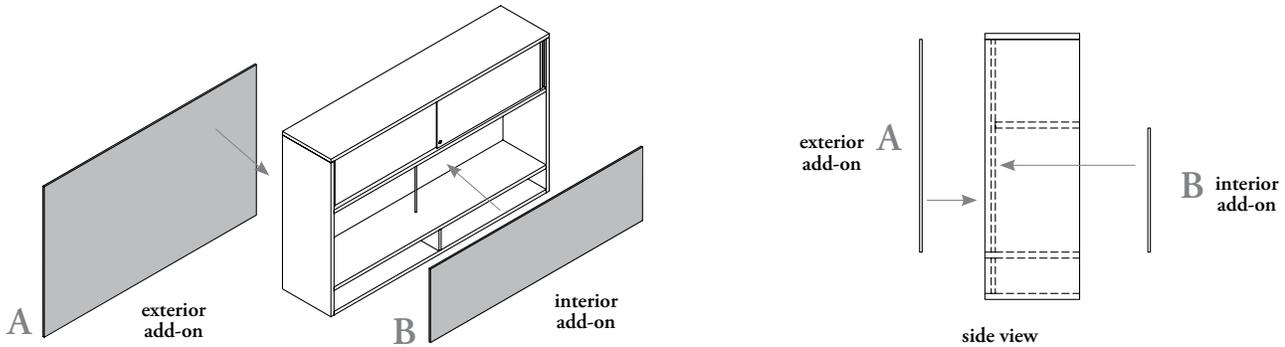

Fascias must be ordered to match the configuration that they are being used on.

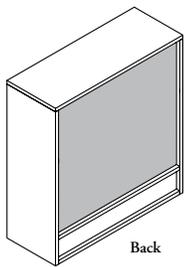

### Single Sided, Back

- Spans over the hutch and the overhead (excludes the back of the cubbies)
- It conceals the seam between the hutch and overhead

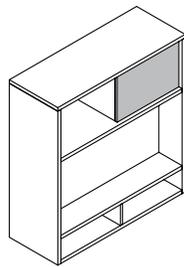

### Shared

- Covers only the back of one side of the overhead
- One fascia for each side is required

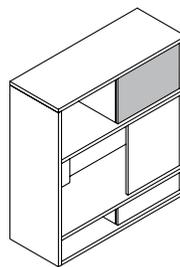

### Aperture

- Covers only the back of one side of the overhead
- One fascia for each side is required

## overhead fascia heights

Overhead heights:

- 8" on 30" high hutch (overall datum height of 51")
- 14" on 45" high hutch (overall datum height of 66")
- The actual fascia width is 2" less than the width of the hutch

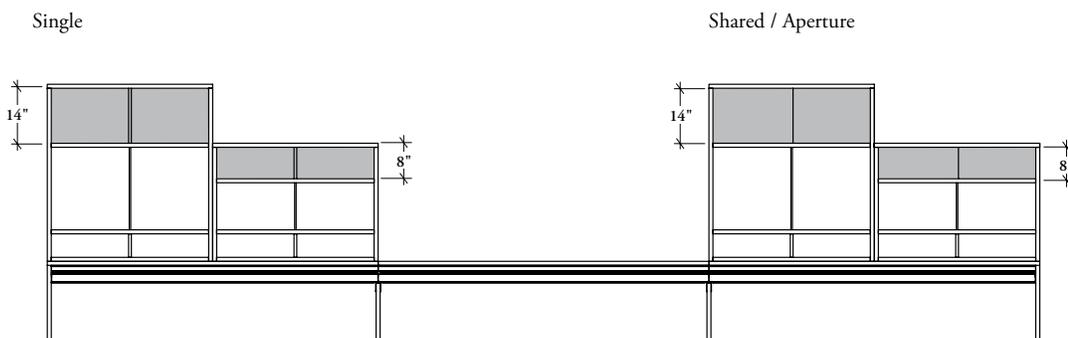

## elevated hutch basics

upStage Elevated Hutches mount on stages or credenzas to provide storage and space division.

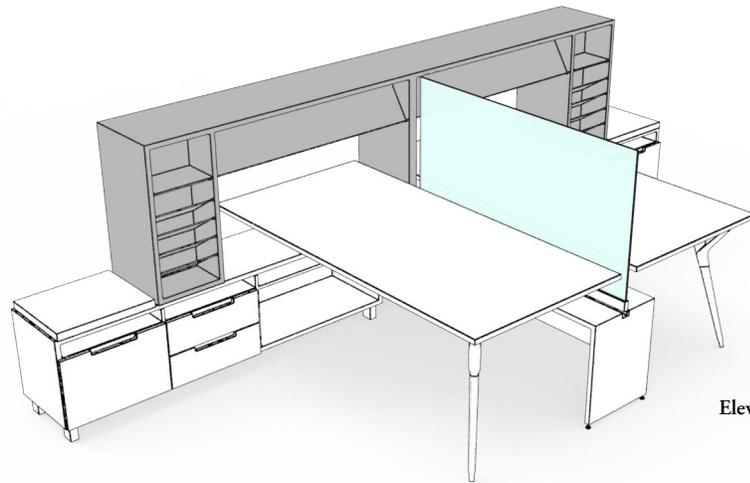

Elevated Hutch Stacker (shown)

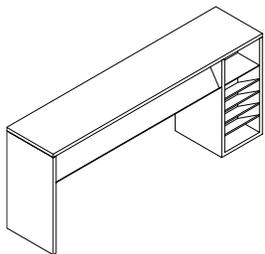

### Elevated Hutch Stacker (HTSHE)

- Elevated hutches are always shared between 2 users
- Height: 51" datum
- Depth: 16"
- Widths: 60", 66", 72", 78", 84", 90" and 96"
- Styles:
  - Paper storage (shown)
  - Hinged doors
  - Door is lockable

# planning with elevated hutches

The following should be considered when planning with Elevated Hutches.

## lateral tower styles

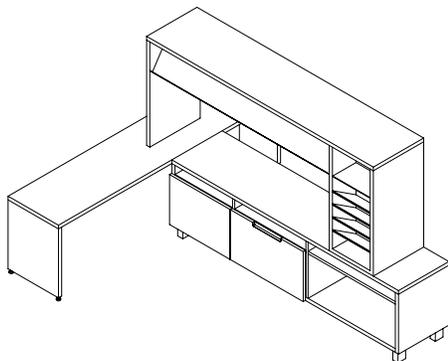

### Paper Storage

- An angled display shelf and file slots

## stage planning

Perpendicular worksurfaces can be used when the elevated hutch is mounted to a stage.

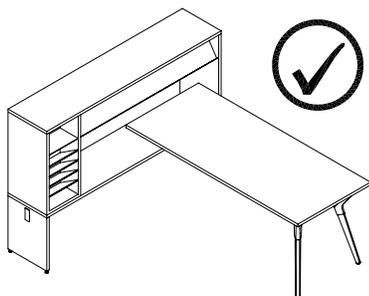

The worksurface must be fixed.

- Mounts inside of the Elevated Hutch Gable

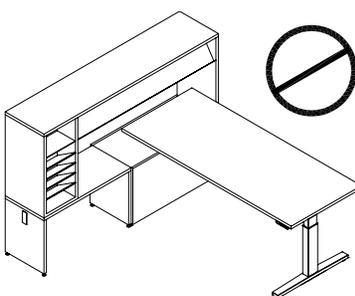

Height-adjustable tables mounted in a Stage Module **cannot** be used when Elevated Hutches are mounted onto a stage.

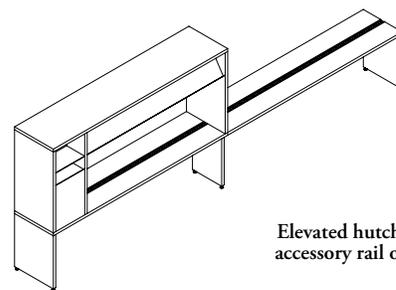

Elevated hutches need an accessory rail on the stage

### Hinged Door

- An angled display shelf
- Open shelves
- Hinged door storage

## credenza planning

Elevated Hutches can be mounted to upStage and District Credenzas, they are both 21" high and 16" deep.

- They can be mounted to:
  - A single credenza
  - Overlap the stage in single sided applications
  - Overlap the stage in side by side applications

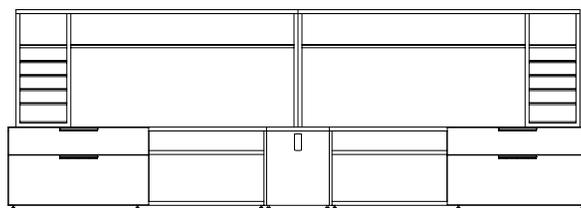
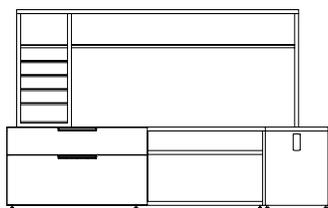

## elevated hutch & lateral tower finishes

**upStage offers an extensive finish offering to allow a user to create their own unique look.**

- Three finish zones:
  - Outer case finish
  - Inner case finish
  - Accent metal

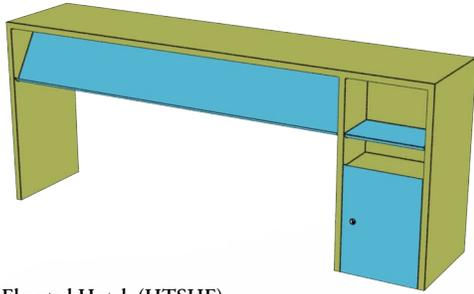

Elevated Hutch (HTSHE)



storage

# storage

UNDERSTANDING CREDENZAS . . . . .	168
STAGE CREDENZAS BASICS . . . . .	170
PLANNING WITH STAGE CREDENZAS. . . . .	171
ELEVATED CREDENZAS BASICS . . . . .	172
PLANNING WITH ELEVATED CREDENZAS. . . . .	173
PEDESTAL BASICS . . . . .	174
CREDENZA FINISHES. . . . .	175
BOOKCASE BASICS. . . . .	177
PLANNING WITH BOOKCASES . . . . .	178
BOOKCASE FINISHES. . . . .	181
VARIABLE BOOKCASE FINISHES . . . . .	182
HINGED DOOR STACKER BASICS . . . . .	183
PLANNING WITH HINGED DOOR STACKERS. . . . .	184
HINGED DOOR STACKER FINISHES . . . . .	185
LOCKER BASICS. . . . .	186
PLANNING WITH LOCKERS . . . . .	187
LOCKER FINISHES . . . . .	188
STORAGE SUPPORT BASICS . . . . .	189
LATERAL TOWER BASICS . . . . .	190
PLANNING WITH LATERAL TOWERS. . . . .	191
SIDE FILER & MINI SIDE FILER BASICS . . . . .	194
PLANNING WITH SIDE FILERS & MINI SIDE FILERS . . . . .	195
PLANNING WITH SIDE FILERS . . . . .	196
PLANNING WITH MINI SIDE FILERS. . . . .	197
PLANNING WITH SIDE FILER, MINI SIDE FILER & USB POWER	198
STORAGE CUBE BASICS . . . . .	200
PLANNING WITH STORAGE CUBE . . . . .	201

## understanding credenzas

upStage credenzas are available in a variety of sizes and configurations to meet all of a users filing and storage needs.

Credenzas are available single sided, or shared.

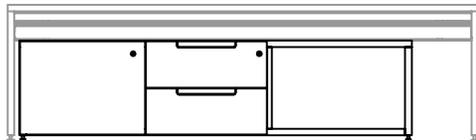

### Stage Credenza

Stage credenzas are 15"h. and sit below the stage in parallel or perpendicular applications

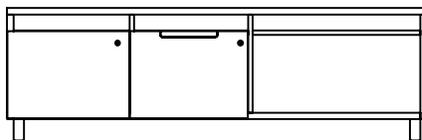

### Elevated Credenza

Elevated credenzas are 21"h. and match the depth and height of a stage

- Can be used parallel or perpendicular to a stage or support stackers

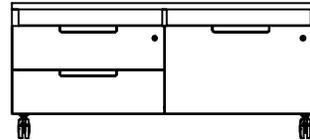

### Elevated Credenza with Casters

Elevated credenzas with casters are 21"h. and match the depth and height of a stage

- Provide user movability



# understanding credenzas (continued)

## handedness

Single Sided Credenzas are always specified from the left to the right and have four options for storage.

- F- File
- B- Box/Box
- H- Hinged Door
- C- Cubby

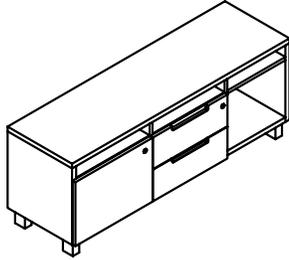

Example: Hinged Door, Box/Box, Cubby Door (H/B/C)

- Shared Double Credenzas are handed
- The handedness is determined by the location of the drawer when viewed by the user

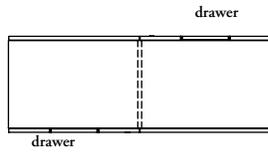

Left handed shown

- Shared Triple Credenzas are handed
- The handedness is determined by the location of the drawer when viewed by the user

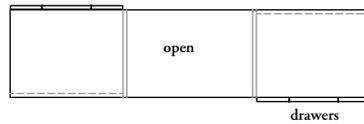
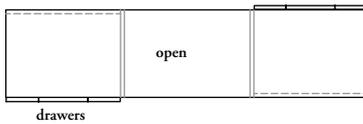
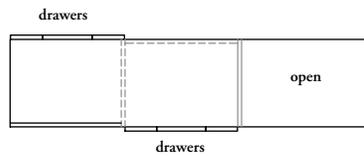
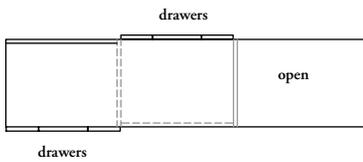
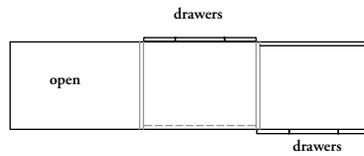
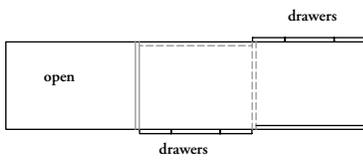

Left handed shown

Right handed shown

## stage credenzas basics

upStage Credenzas are used below the stage to provide storage and are available in a variety of configurations.

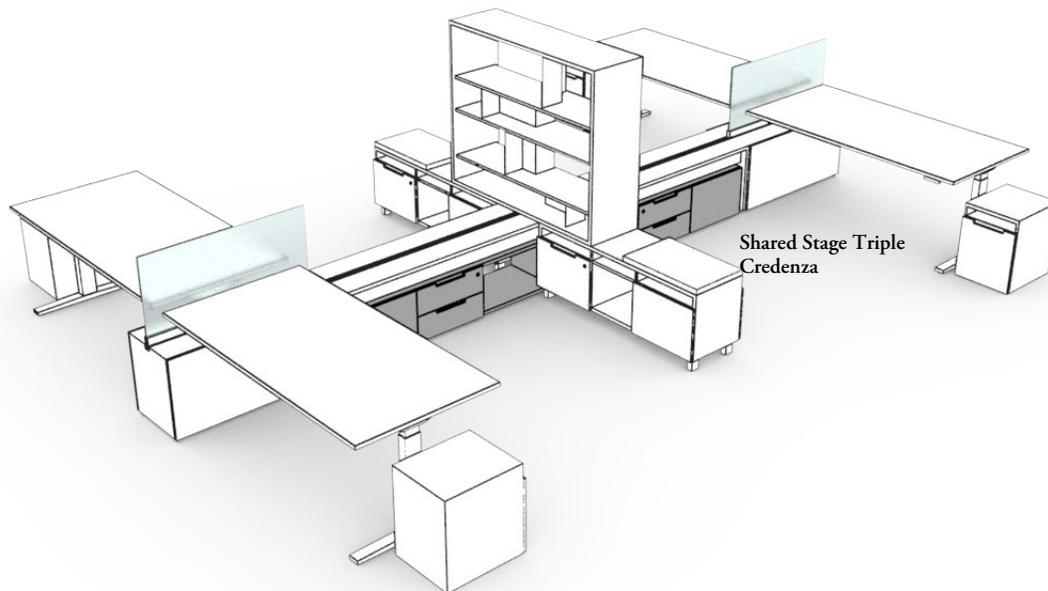

- Height: 15"
- Formats:  
Box/Box  
File  
Hinged door (hinged doors have touch latch hardware and no handles)
- Single and shared configurations
- Provides support to stages that are 72w" or wider
- Power and data cannot route through stage credenzas



### Stage Single Credenza (HTSCJ)

- Widths: 24", 30" and 36"
- Includes one file drawer
- Must be used under a stage, and is not freestanding



### Stage Double Credenza (HTSCW)

- Widths: 30", 36", 42" and 48"
- Includes two sections, both facing the same direction
- Configurations:
  - File/Hinged Door (FH)
  - Hinged Door/File (HF)
  - Box, Box/Hinged Door (BH)
  - Hinged Door/Box, Box (HB)
  - File/File (FF)
  - File/Box, Box (FB)
  - Box, Box/File (BF)
- Counterweight Options:
  - If used freestanding counterweights must be specified on credenzas with file drawers
  - If used under the stage, counterweights are not required but are recommended for reconfiguration flexibility

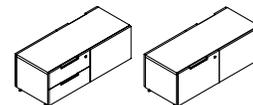

### Stage Shared Double Credenza (HTSCU)

- Widths: 42", 48", 60" and 72"
- Includes two sections, one facing each direction
- Configurations:
  - File (F)
  - Box/Box (B) (not available on 60" or 72" w credenzas)
- Counterweight Options:
  - If used freestanding counterweights must be specified on credenzas with file drawers
  - If used under the stage, counterweights are not required but are recommended for reconfiguration flexibility

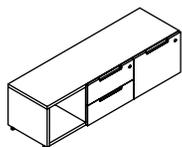

### Stage Triple Credenza (HTSCZ)

- Widths: 54", 60", 66" and 72"
- Includes three sections, all facing the same direction
- Configurations:
  - Hinged Door/File/Cubby (HFC)
  - Cubby/File/Hinged Door (CFH)
  - Hinged Door/Box, Box/Cubby (HBC)
  - Cubby/Box, Box/Hinged Door (CBH)
  - File/Box, Box/Cubby (FBC)
  - Cubby/Box, Box/File (CBF)
  - File/Box, Box/Hinged Door (FBH)
  - Hinged Door/Box, Box/File (HBF)
- Does not require counterweights

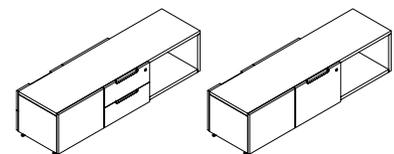

### Stage Shared Triple Credenza (HTSCV)

- Widths: 54", 60", 66" and 72"
- Includes three sections, one facing each direction, and one open through cubby
- Configurations:
  - File (F) (accessory option not available)
  - Box/Box (B)
- Counterweights are not required

# planning with stage credenzas

The following should be considered when planning with Stage Credenzas.

- Stage credenzas can be planned parallel or perpendicular to the stage
- Provide support for stages 72" w or wider

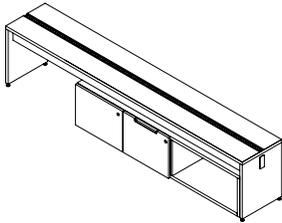

parallel

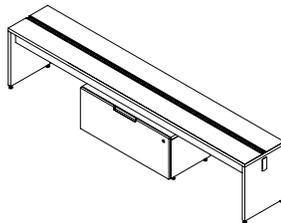

centered  
(For Stage Support)

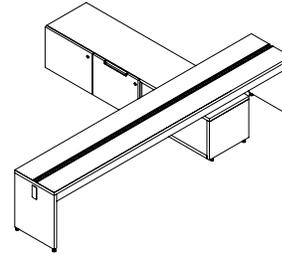

perpendicular

Stage credenzas planned in parallel positions must be specified at least one size narrower than the overall width of the stage to allow for the thickness of the gables on either side.

Stage credenzas planned in perpendicular positions must be specified with a cubby under the stage.

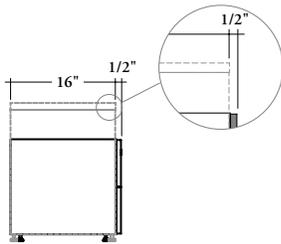

- The credenza depth of 16" is nominal
- The drawer fronts will sit outside of the stage



Worksurfaces **cannot** be mounted to Stage Credenzas, the heights do not align.



**Planning Tip**

- Stage Credenzas can support stackers, but do not match standard datum heights
- To reach the 21" high datum requirement for stackers a Stage Spacer Block (HTAS) is required. See *Accessory Section* for more details

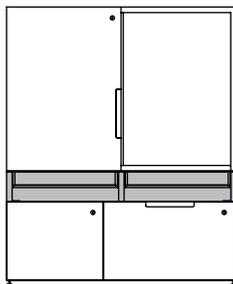

stage credenza with  
spacer block

## elevated credenzas basics

upStage Elevated Credenzas are the same height as a Stage and can be planned parallel and perpendicular to the Stage to provide storage.

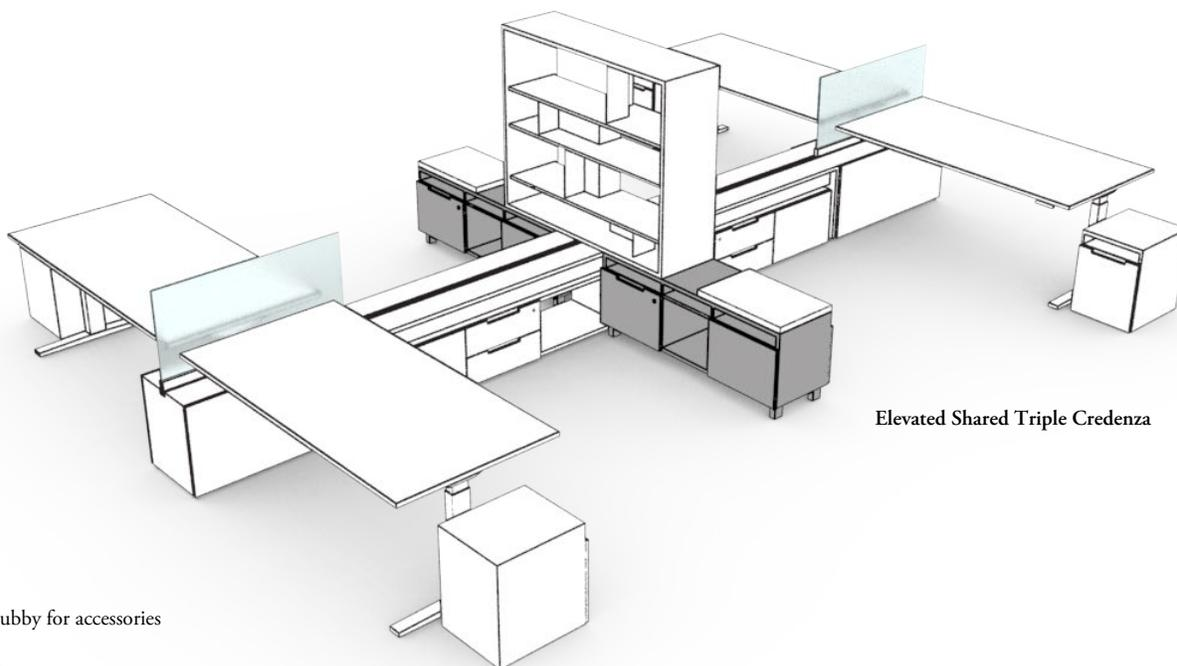

Elevated Shared Triple Credenza

- Height: 21"
- Includes a cubby for accessories
- Formats:
  - Box/Box (B)
  - File (F)
  - Hinged door (hinged doors have touch latch hardware and no handles)
- Single and shared configurations
- Can support worksurfaces
- Power and data cannot route through Elevated Credenzas



### Elevated Double Credenza (HTSCY)

- Widths: 30", 36", 42" and 48"
- Includes two sections, both facing the same direction
- Available with either feet or casters
- Configurations:
  - Box, Box/Cubby (BC)
  - Box, Box/Hinged Door (BH)
  - File/Cubby (FC)
- Counterweight is included in file configurations

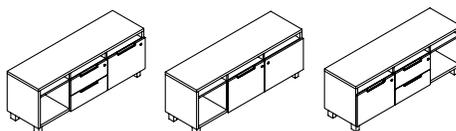

### Elevated Triple Credenza (HTSCX)

- Widths: 54", 60", 66" and 72"
- Includes three sections, all facing the same direction
- Configurations:
  - Cubby/Box, Box/File (CBF)
  - Cubby/File/Hinged Door (CFH)
  - File/Box, Box/Cubby (FBC)
- Counterweights are not required

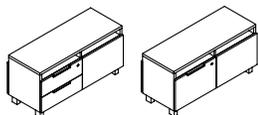

### Elevated Shared Double Credenza (HTSCR)

- Widths: 42" and 48"
- Includes two sections, one facing each direction
- Configurations:
  - File (F)
  - Box/Box (B)
- Counterweights are required in freestanding applications

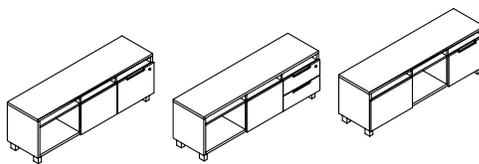

### Elevated Shared Triple Credenza (HTSCQ)

- Widths: 54", 60", 66" and 72"
- Includes three sections, one facing each direction, and one open through location
  - The open through location can be on the side or centered
- Configurations:
  - File (F)
  - Box/Box (B)
- Counterweights are not required

# planning with elevated credenzas

The following should be considered when planning with Elevated Credenzas.

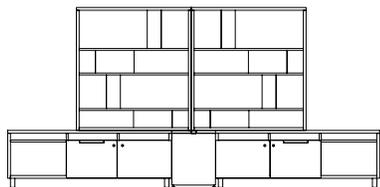

- Elevated Credenzas are 21" h. the same height as a stage
- They can accommodate stacked storage when used in perpendicular applications

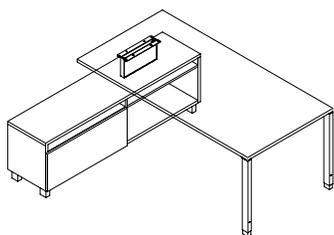

- Elevated Double Credenza configurations with an opening can support a work surface
- The work surface must mount over the opening
- Credenza to Worksurface Support (HTSCY) must be specified over an open cubby
- The Cubby Shelf is removable to allow the work surface support to be installed
- The back of the cubby section will be solid

When installed on worksurfaces 30" or 36" deep, the support bracket is centered to the work surface.

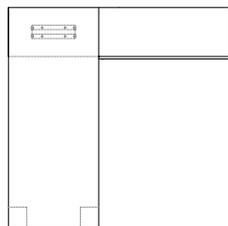

When installed on a work surface 24" deep, the support bracket is centered to the credenza cubby.

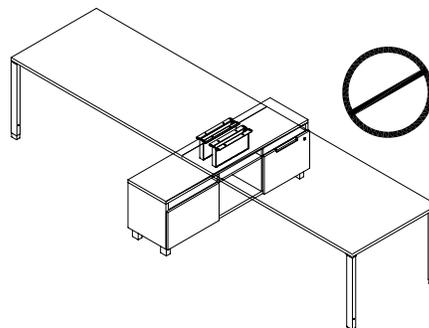
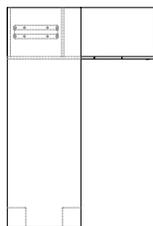

- Elevated Shared Credenzas have a solid back on the back side of each drawer configuration to provide a seamless aesthetic
- Credenzas with a center cubby cannot support a work surface, the open through must be on an end location
- Cubby spaces are open from both sides

The following outlines the size of work surface a credenza can support.

- 54" w. - up to 24" d. work surface
- 60" w. - up to 30" d. work surface
- 66" w. - up to 36" d. work surface
- 72" w. - all work surface depths

## integrating accessories

- Cubby spaces on all Elevated Credenzas can accommodate mobile cubby trays
- Mobile Cubby Trays can be oriented horizontally or vertically to fill the cubby space

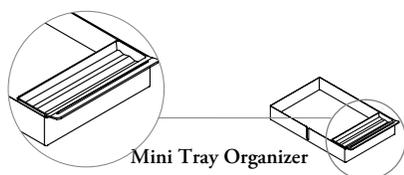

Cubby space

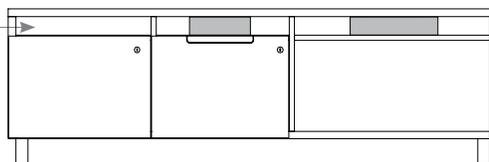

- The Mini Tray organization attaches to the Mobile Cubby Tray to provide storage for small items
- It is also used as a handle

## pedestal basics

upStage Mobile Pedestals provide additional personal storage in a workstation.

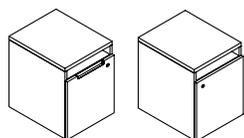
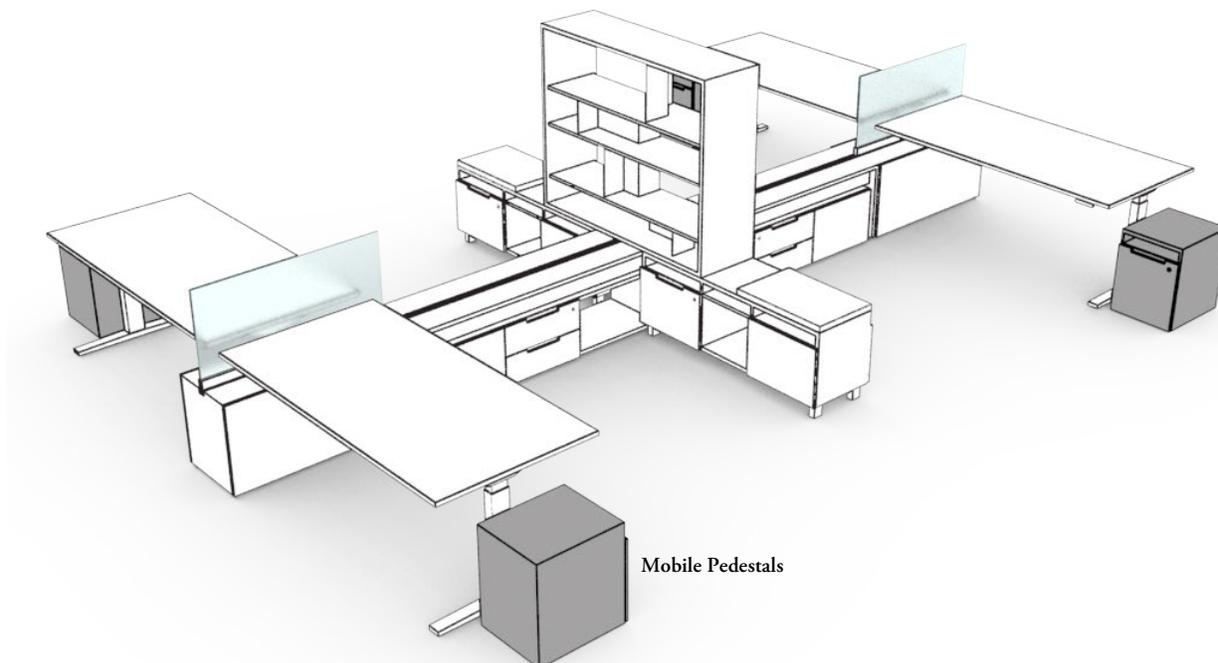

### Mobile Pedestal (HTSM)

- Widths: 16"
- Height: 21"
- Depth: 19"
- Configurations:
  - Hinged Door
  - File Drawer
- Optional seat cushion available (HTAC)

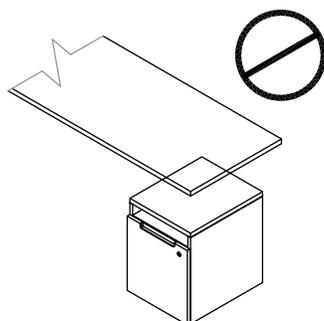

The rolling Pedestal **cannot** be used for support.

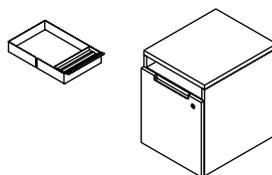

The top cubby accommodates Mobile Accessory Trays (HTAT).

# credenza finishes

upStage offers an extensive finish offering, to allow a user to create their own unique look.

## Stage Credenza Finishes

- Two finish zones
  - Case and back (will always be the same)
  - Front

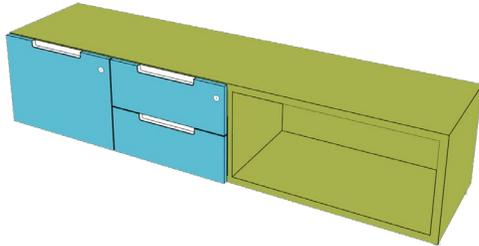

- Elevated Shared Double Credenza (HTSCR)
- Elevated Shared Triple Credenza (HTSCQ)
- Elevated Triple Credenza (HTSCX)
- Elevated Double Credenza (HTSCY)
- Mobile Pedestal (HTSM)

Case, Shelves, Front and Back Finish	Shelves Finish	Front and Back Finish
Flintwood	Flintwood	Flintwood
Natural Veneer	Natural Veneer	Natural Veneer
Source Laminate	Source Laminate	Source Laminate Flintwood

### Foot Finishes:

- Storm white
- Platinum
- Very white
- Anthracite
- Graphite
- Burnished bronze

### Handle Paint Finishes:

- Foundation
- Mica
- Accent

# credenza finishes (continued)

## Elevated Credenza and Mobile Pedestal Finishes

- Three finish zones
  - Case and back (will always be the same)
  - Shelves & dividers
  - Front

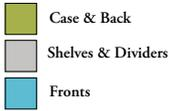
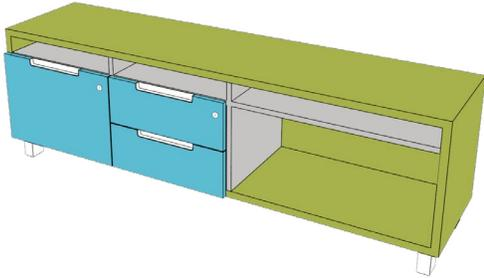

### Stage Shared Double Credenza (HTSCU) Stage Shared Triple Credenza (HTSCV)

Case Finish	Front and Back Finish
Flintwood	Flintwood
Natural Veneer	Natural Veneer
Source Laminate	Source Laminate Flintwood

### Stage Single Credenza (HTSCJ) Stage Double Credenza (HTSCW) Stage Triple Credenza (HTSCZ)

Case & Back Finish	Front Finish
Flintwood	Flintwood
Natural Veneer	Natural Veneer
Source Laminate	Source Laminate Flintwood



# bookcase basics

upStage Bookcases stack onto stages or credenzas to provide storage and space division, and are available in a variety of configurations.

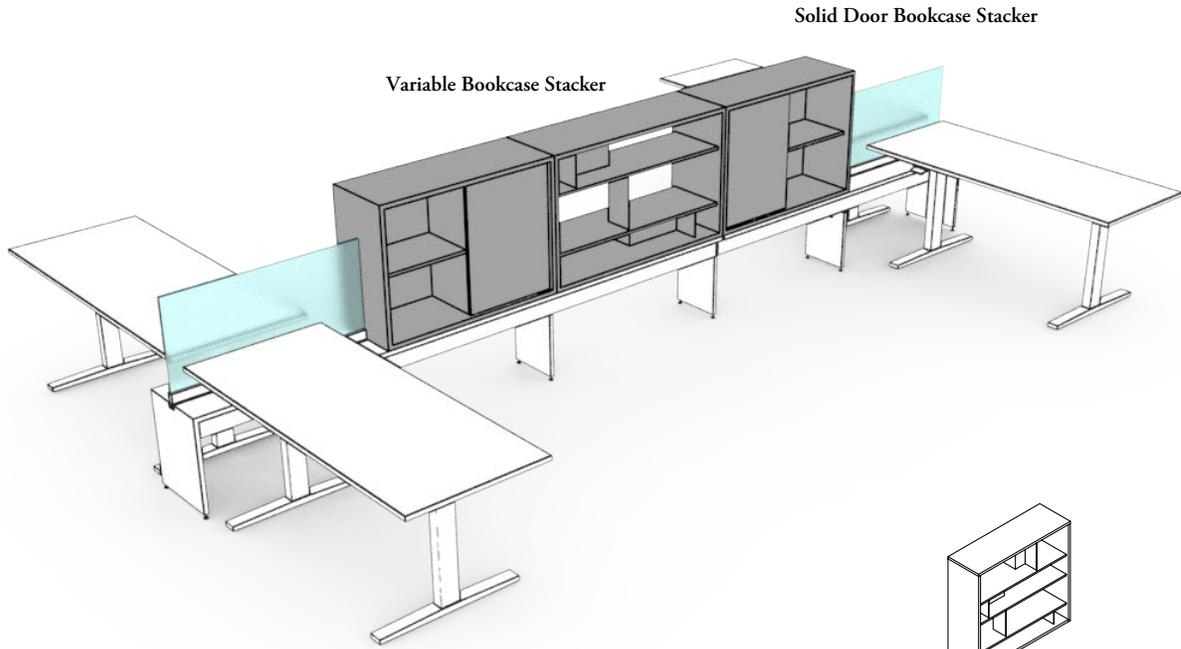

All bookcases listed below:

- Depth: 16"
- Applications:
  - Single
  - Shared

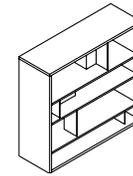

### Variable Bookcase Stacker (HTSBV)

- Depth: 16"
- Provides open bookcase storage with variable privacy
- Heights: 21", 30" and 45"
- Widths: 30" - 72" in 6" increments

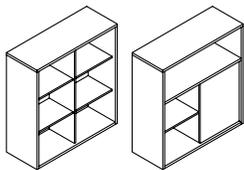

Single Shared, Open Through Top

### Bookcase Stacker (HTSB)

- A bookcase with open shelves only
- Heights: 21", 30", 45"
- Widths:
  - Single -24", 30", 36", 42", 48"w
  - Shared -30", 36", 42", 48", 60", 66" and 72"
- Configurations:
  - Shelves
  - Shelves with open through top

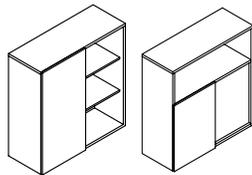

Single Shared, Open Through Top

### Solid Door Bookcase Stacker (HTSBS)

- A bookcase with a solid sliding door
- Heights: 21", 30", 45"
- Widths:
  - Single -42", 48"w
  - Shared -42", 48", 60", 66" and 72"
- Configurations:
  - Shelves with solid sliding door panel
  - Shelves with open through top and sliding door panel

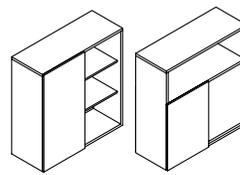

Single Shared, Open Through Top

### Writeable Door Bookcase Stacker (HTSBW)

- A bookcase with a writeable sliding door
- Heights: 30", 45"
- Widths:
  - Single -42", 48"w
  - Shared -42", 48", 60", 66" and 72"
- Configurations:
  - Shelves with backpainted glass sliding door panel
  - Shelves with open through top and backpainted glass sliding door panel
- Te glass frame finish coordinates with the finish of the glass

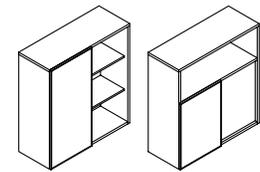

Single Shared, Open Through Top

### Fabric Door Bookcase Stacker (HTSBF)

- A bookcase with a fabric sliding door
- Heights: 30", 45"
- Widths:
  - Single -42", 48"w
  - Shared -42", 48", 60", 66" and 72"
- Configurations:
  - Shelves with fabric sliding door panel
  - Shelves with fabric open through top and fabric sliding door panel
  - fabric is tackable
- Door Trim Finishes:
  - Clear Anodized
  - Espresso
  - Very White

# planning with bookcases

The following chart outlines the configurations available with upStage Bookcase Stackers.

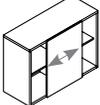
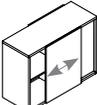
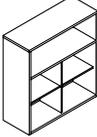
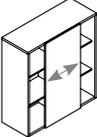
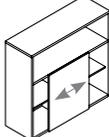
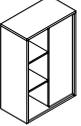
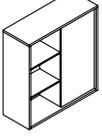
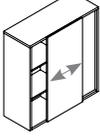
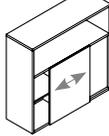
	Bookcase		Bookcase with Sliding Door (Solid, Back-Painted Glass, Fabric)	
	Shelves	Shelves with open through top	Shelves with sliding door panel	Shelves with sliding door panel and open through top
21" High, Single		×	×	×
21" High, Shared		×	×	×
30" High, Single		×		×
30" High, Shared		×		×
45" High, Single				
45" High, Shared				

# planning with bookcases (continued)

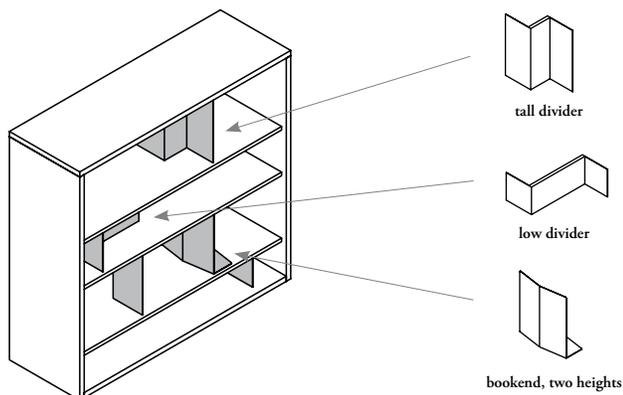

tall divider



low divider



bookend, two heights

The number of tall and low dividers depends on the height of the Variable Bookcase.

**21" High**

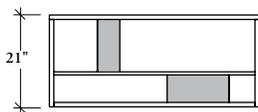

Includes one tall divider and one low divider.

**30" High**

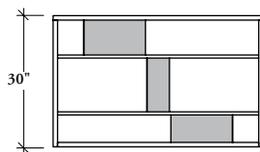

Includes one tall divider and two low dividers.

**45" High**

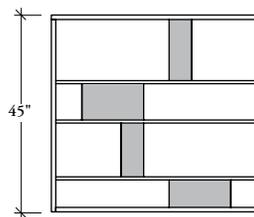

Includes two tall dividers and two low dividers.

## planning with bookcases (continued)

### shared bookcases

Handedness is determined by the location of the open shelves.

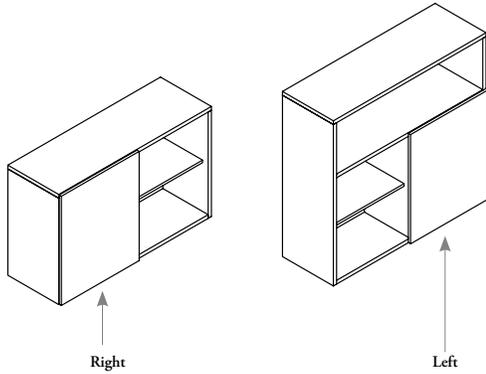

### sliding door panel

- The case depth of 16" is nominal
- The door panel will sit outside of the case

Worksurfaces cannot be mounted to a bookshelf, the shelves are recessed into the case.

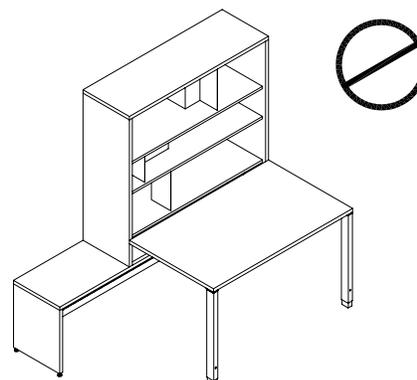
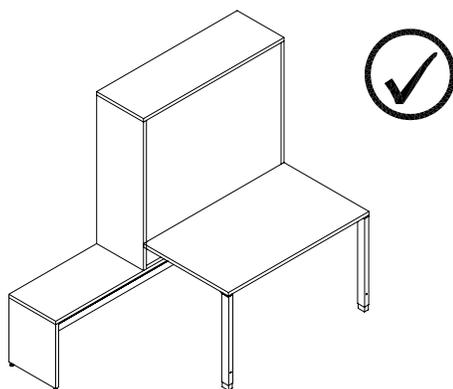
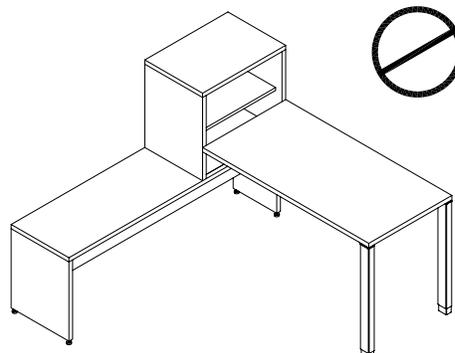
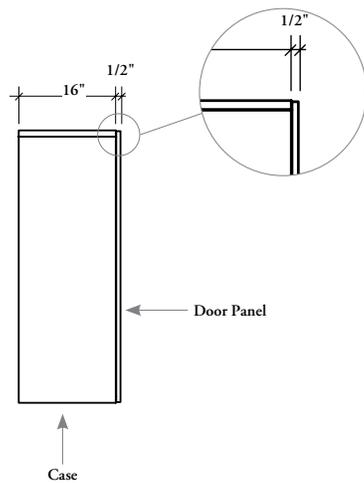

Worksurfaces can only mount to the back of a Single-Sided Bookcase Stacker using two Storage Back to Worksurface Support (HTWS).

Worksurfaces **cannot** mount to a variable bookcase.

# bookcase finishes

upStage offers an extensive finish offering to allow a user to create their own unique look.

### Bookcase Stacker (HTSB)

- Two finish zones
  - Case
  - Secondary which has three options
    - A - Shelves & Dividers only
    - B - Backs only
    - C - Shelves & Interior Dividers & Backs

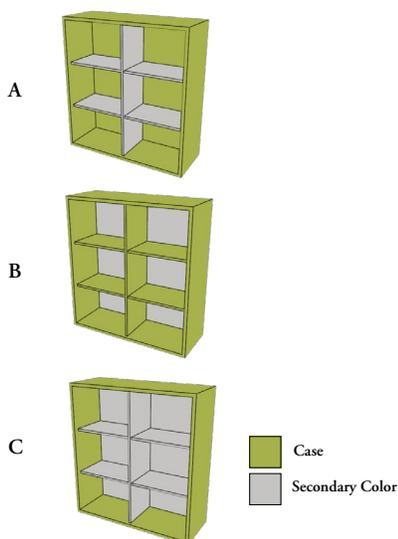

### Bookcase Stacker, with Sliding Door Fabric Door Bookcase Stacker (HTSBF) Writeable Door Bookcase Stacker (HTSBW) and Solid Door Bookcase Stacker (HTSBS)

- Three finish zones
  - Case
  - Secondary which has three options
    - A - Shelves & Dividers only
    - B - Backs only
    - C - Shelves & Interior Dividers & Backs
  - Fronts

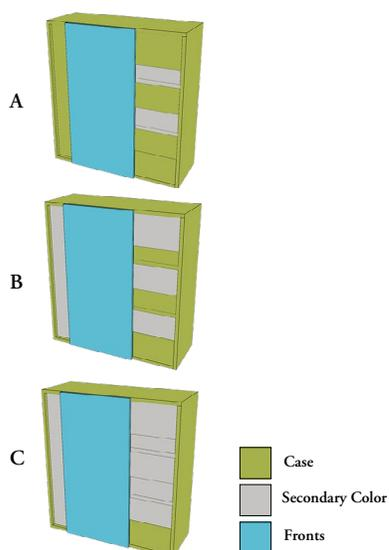

### Bookcase Stacker (HTSB)

Case Finish	Secondary Finish
Flintwood	Flintwood
Natural Veneer	Natural Veneer
Source Laminate	Source Laminate

### Bookcase Stacker Writeable Door Bookcase Stacker (HTSBW) Fabric Door Bookcase Stacker (HTSBF)

Case Finish	Secondary Finish	Front Finish
Flintwood	Flintwood	Writeable Door Bookcase Stacker (HTSBW): Storm White Very White Soft Gris
Natural Veneer	Natural Veneer	
Source Laminate	Source Laminate	Fascia Door Bookcase Stacker (HTSBF): Panel Fabrics

### Bookcase with Solid Sliding Door (HTSBS)

Case Finish	Secondary Finish	Front Finish
Flintwood	Flintwood	Flintwood
Natural Veneer	Natural Veneer	Natural Veneer
Source Laminate	Source Laminate	Source Laminate Flintwood

## variable bookcase finishes

upStage offers an extensive finish offering to allow a user to create their own unique look.

- Four finish zones
  - Case
  - Shelves
  - Tall dividers
  - Low dividers

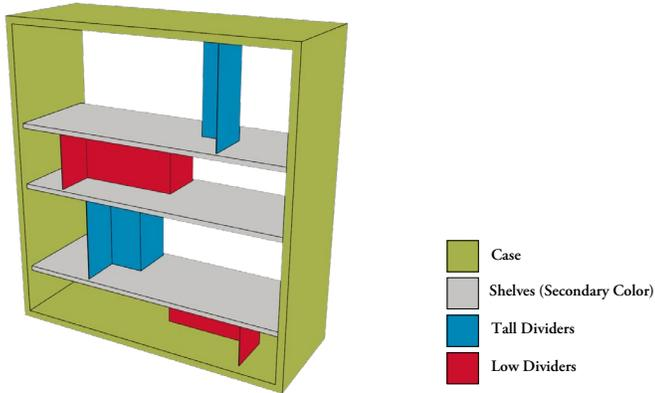

### Variable Bookcase Stacker (HTSBV)

Case Finish	Shelves Finish
Flintwood	Flintwood
Natural Veneer	Natural Veneer
Source Laminate	Source Laminate

Dividers:  
Mica  
Foundation  
Accent Colors

# hinged door stacker basics

upStage Hinged Door Stackers stack onto Stages or Credenzas to provide closed storage.

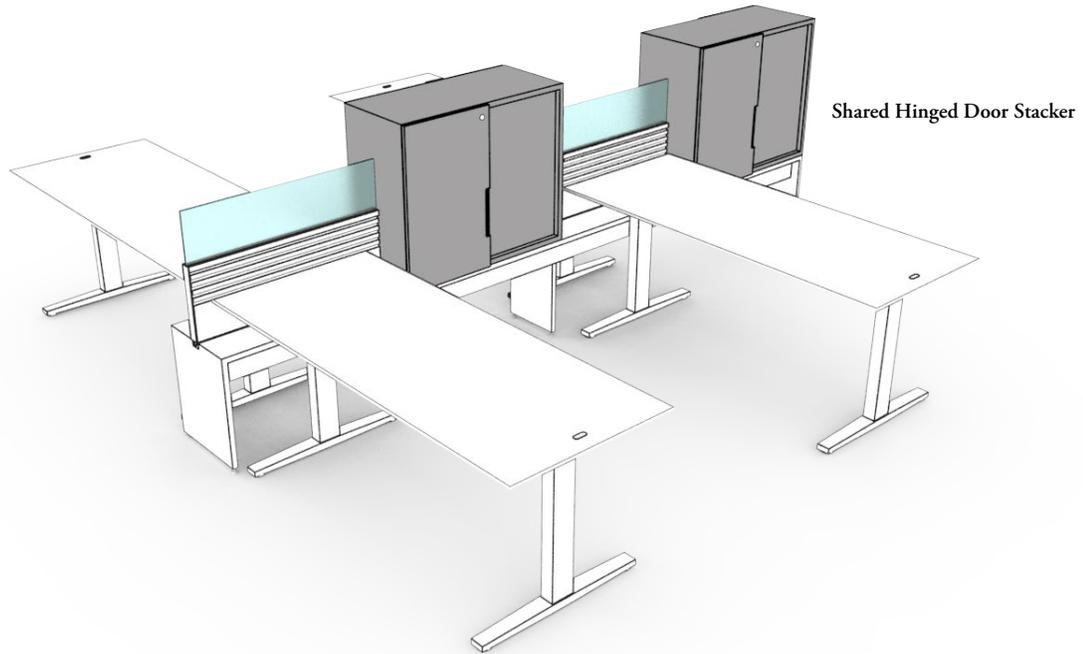

- Heights: 21", 30" and 45"
- Widths: 30", 36", 42" and 48"
- All doors are hinged
- Push Latch or upStage handle available
- With Push Latch option, no handle is required
- Lock options available
- Handle Styles:
  - Push Latch, no handle required
  - upStage handle

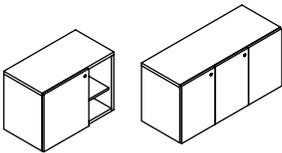

Open with Cubbies All Closed

### Single Solid Hinged Door Stacker (HTSSS)

- Two options available:
  - Closed door with open cubbies
  - Closed doors
- Used in single sided applications

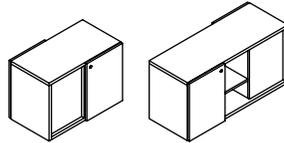

### Shared Solid Hinged Door Stacker (HTSSD)

- The hinged door is solid
- Two options available:
  - Closed door with open cubbies (available on 42" and 48" w, the cubbies will be centered)
  - Closed doors
- Used in shared applications, one door will face in each direction

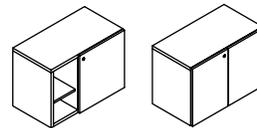

Open with Cubbies All Closed

### Single Writeable Hinged Door Stacker (HTSSG)

- The hinged door is back-painted glass
- Two options available:
  - Closed door with open cubbies
  - Closed doors
- Used in single sided applications
- Only the push latch option is available
- The glass frame finish will coordinate with the finish of the glass

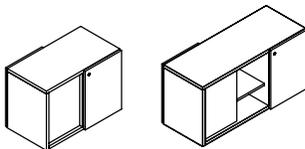

### Shared Writeable Hinged Door Stacker (HTSSP)

- The hinged door is writable
- Two options available:
  - Closed door with open cubbies (available on 42" and 48" w, the cubbies will be centered)
  - Closed doors
- Used in shared applications, one door will face in each direction

## planning with hinged door stackers

The following should be considered when planning with upStage Hinged Door Stackers.

### single application

- On cabinets with doors:
  - 30" and 36"w. have two doors
  - 42" and 48"w. have three doors
    - Two doors will be connected and one will be a single door
    - The handedness is determined by the location of the single door

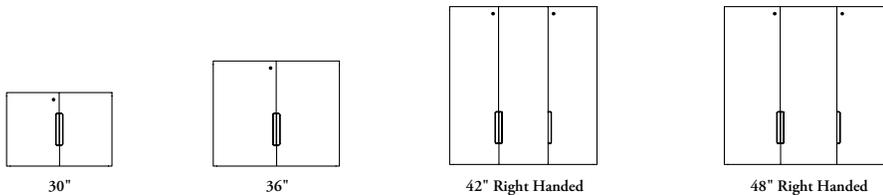

- On cabinets with doors and cubbies:
  - 30" and 36"w. have one door and one cubby section
  - 42" and 48"w. have two doors and one cubby section
    - The handedness is determined by the location of the open cubbies

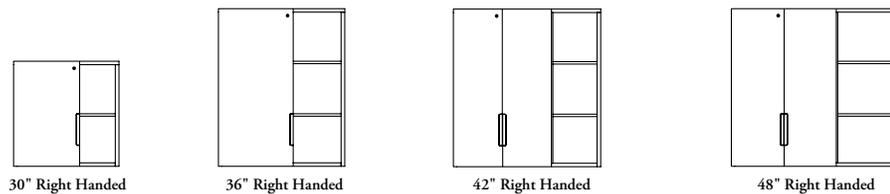

### shared application

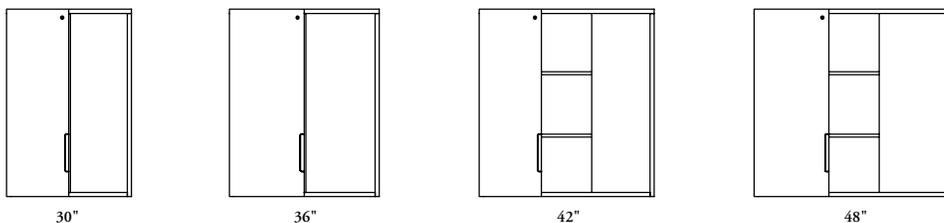

- On cabinets with all doors:
  - 30" and 36"w have two doors, one on each side
  - 42" and 48"w have two doors, one on each side, and an open through cubby section in the center
- Widths 42" and 48" have an open through cubby section in the middle



# hinged door stacker finishes

upStage offers an extensive finish offering to allow a user to create their own unique look.

### Single Hinged Door Stackers (HTSSS)

- Three finish zones
  - Case
  - Secondary which has three combinations
    - A Shelves only
    - B Backs only
    - C Shelves & interior dividers & backs
- Front

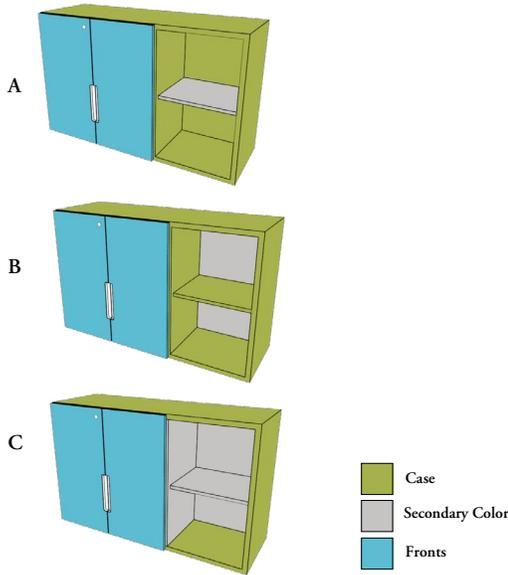

### Shared Hinged Door Stackers (HTSSD)

- Three finish zones
  - Case
  - Secondary which has three combinations
    - A Shelves only
    - B Backs only
    - C Shelves & interior dividers & backs
- Front

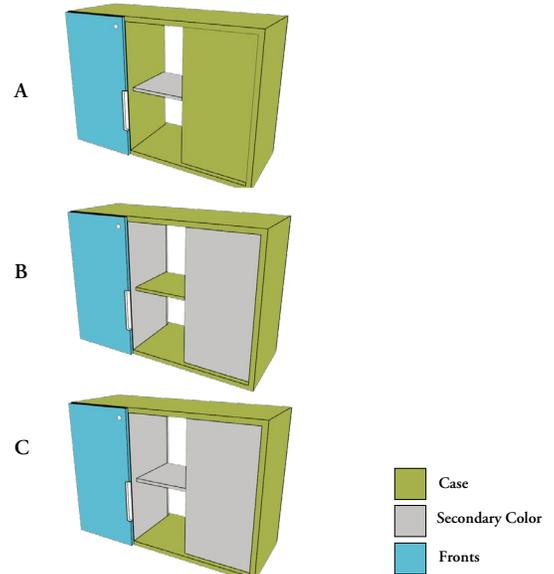

### Single Hinged Door Stacker (HTSSS)

### Shared Hinged Door Stacker (HTSSD)

Case Finish	Secondary Finish	Front Finish
Flintwood	Flintwood	Flintwood Back-Painted Glass
Natural Veneer	Natural Veneer	Natural Veneer Back-Painted Glass
Source Laminate	Source Laminate	Source Laminate Flintwood Back-Painted Glass

## locker basics

upStage Lockers provide personal coat and shelf storage.



Cubby Locker

- Handle Styles:
  - Push latch
  - Upstage handle
- Locks included (digital or custom locks available)

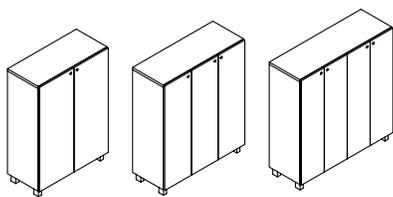

Dual, Push Latch    Triple, Push Latch    Quad, Push Latch

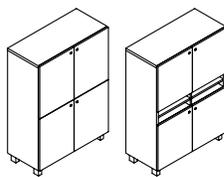

Hinged Door, Push Latch    Hinged Door with Mail Slot, Push Latch

### Lockers (HTSL)

- Lockers have full height doors
- Heights: 42", 51" and 66"h
  - (no push latch available on 66"h)
- Configurations:
  - Dual
  - Triple
  - Quad
- Widths:
  - Dual 30" and 36"w
  - Triple 42" and 48"w
  - Quad 48"w

### Cubby Lockers (HTSLC)

- Cubby lockers have four cubbies per unit
- Configurations:
  - Hinged doors
  - Hinged doors with mail slots
- Heights: 51" and 66"
- Widths: 30", 36" and 42"h.

# planning with lockers

The following should be considered when planning with upStage Lockers.

- Dual and quad lockers are not handed
- Triple lockers are handed, two of the doors will have their handles side by side and the third door will have a single handle
  - The handedness is determined by the location of the hinge on the single door

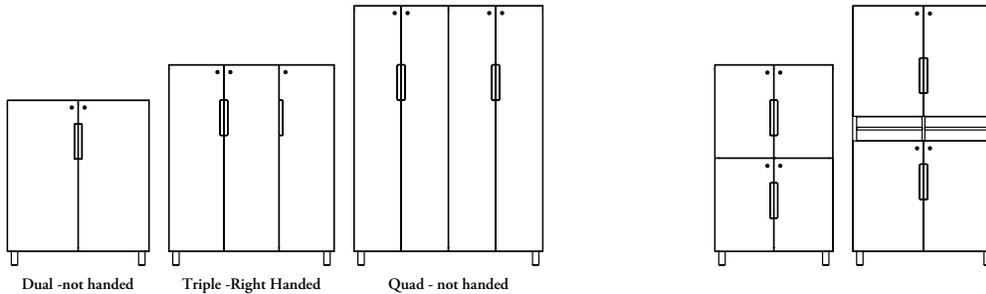

- Each 51" and 66"h locker section includes:
  - One triangular corner shelf
  - One adjustable shelf

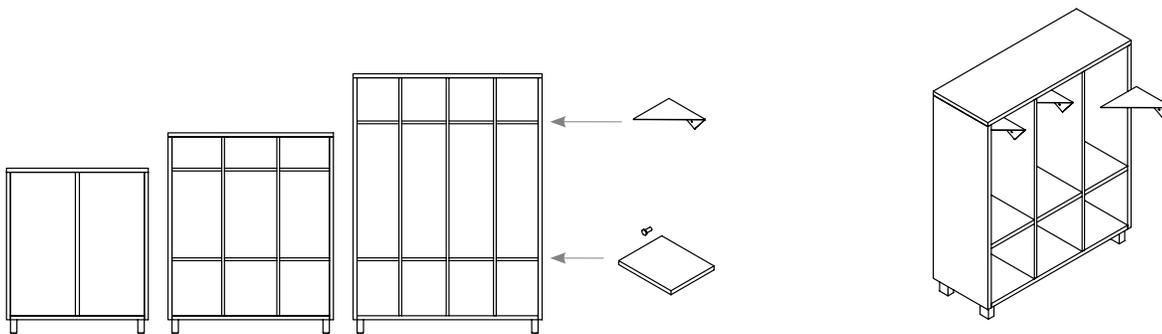

A Locker can provide support to a worksurface using the Storage Back to Worksurface Support (HTWS)

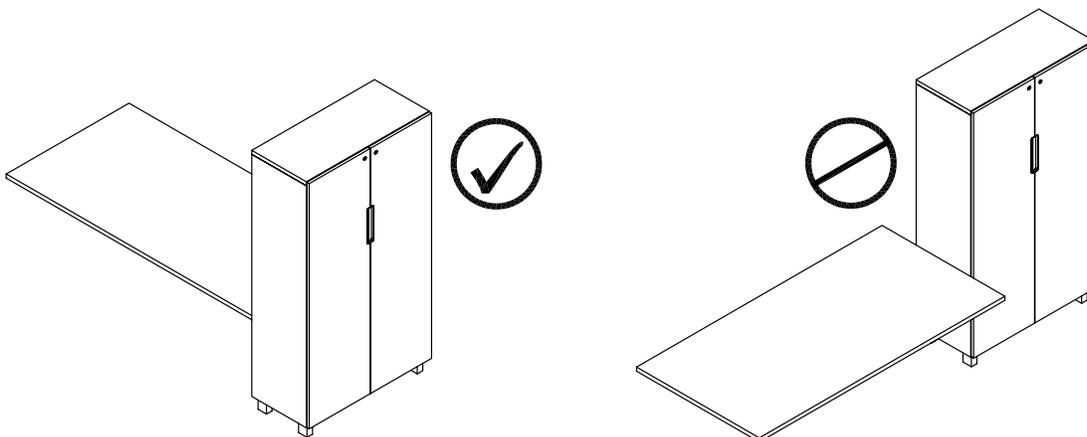

The worksurface must be supported from the back side of the storage.

worksurfaces cannot be supported from the side of a locker.

## locker finishes

upStage offers an extensive finish offering to allow a user to create their own unique look.

- Two finish zones:
  - Case
  - Front

**Lockers (HTSL)**

**Cubby Lockers (HTSLC)**



**Lockers (HTSL)**  
**Cubby Lockers (HTSLC)**

Case Finish	Front Finish
Flintwood	Flintwood
Natural Veneer	Natural Veneer
Source Laminate	Source Laminate Natural Veneer

- Foot finishes:**
- Storm White
  - Platinum
  - Very White
  - Anthracite
  - Graphite
  - Burnished Bronze

# storage support basics

Worksurface supports connect worksurfaces horizontally either to the back of a stacker, credenza or to a hutch.

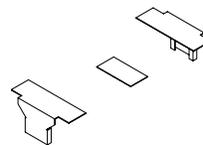
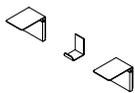
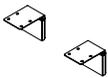
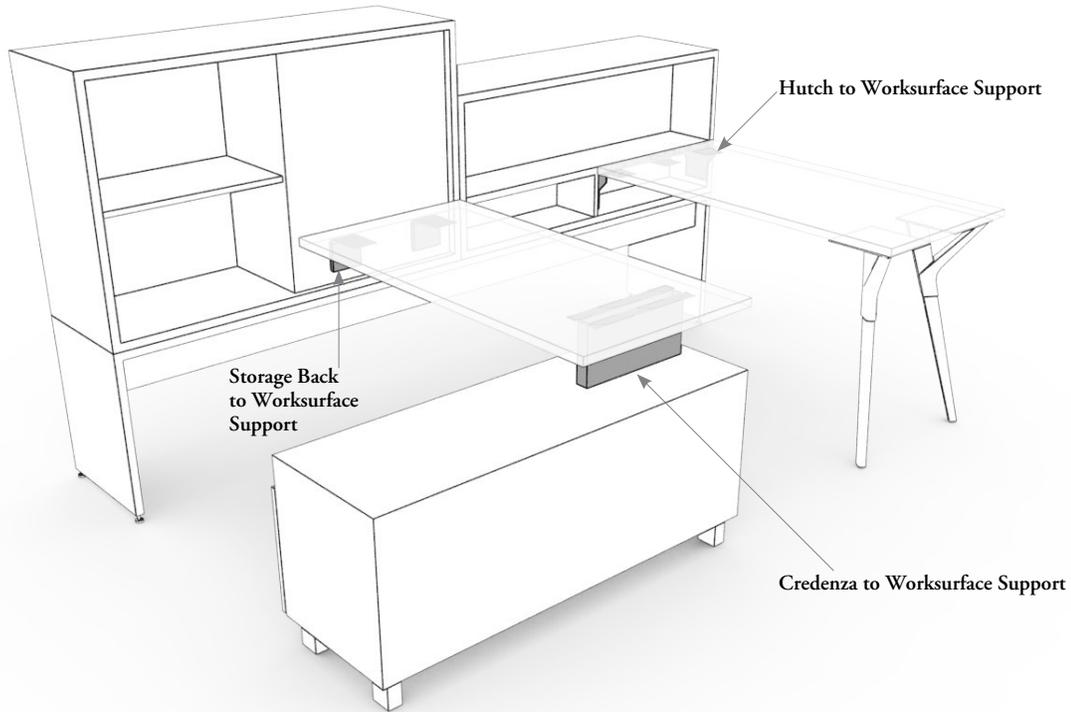

### Storage Back to Worksurface Support (HTWS)

- Used to attach a worksurface to the back of stacking storage
- Available only as a pair (two)

### Credenza to Worksurface Support (HTWC)

- Mounts to the underside of a worksurface and to the top of the credenza to provide support to the worksurface
- Available Fixed or Height-Adjustable

### Hutch to Worksurface Support (HTWF)

- Used to attach a worksurface to a Hutch
- Brackets that are included are dependent on the Hutch style, size and worksurface depth

## lateral tower basics

Lateral Towers mount to stages and elevated credenzas to provide functional space division and an impromptu collaboration surface.

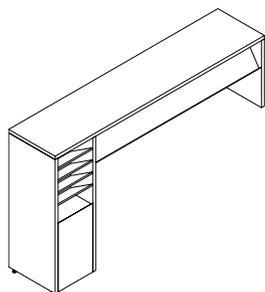
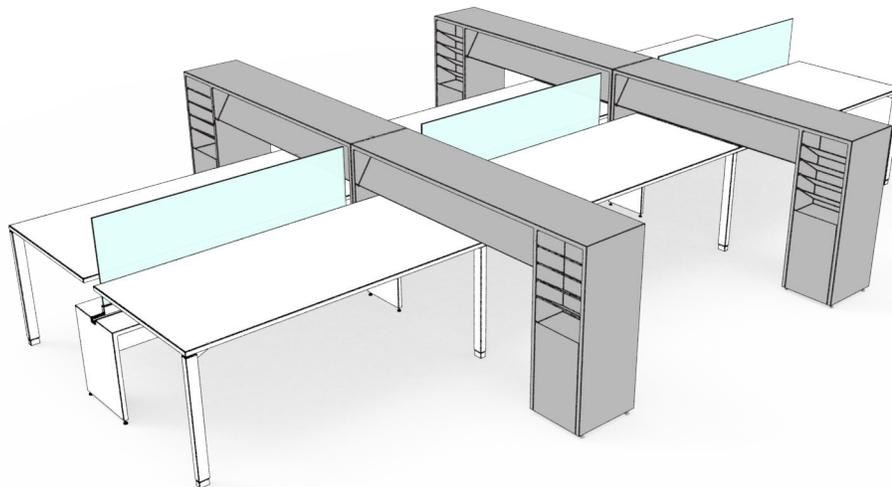

### Lateral Tower (HTST)

- Height: 42"
- Depth: 16"
- Widths: 60", 66", 72"
- Mounts to a stage or credenza
- Styles:
  - Basic Gable
  - Storage Tower (lockable)
- Applications:
  - Single Sided
  - Shared

# planning with lateral towers

The following should be considered when planning with lateral towers.

Lateral Towers are available in four styles:

- storage shared
- storage single sided
- solid gable shared
- solid gable single sided

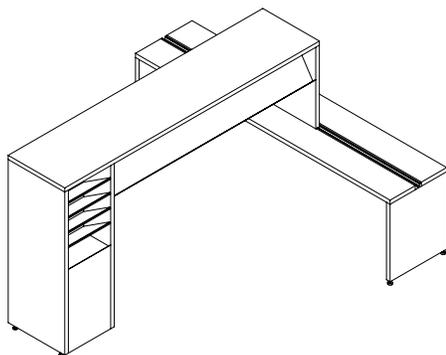

### Storage - Shared

- Mounts to a stage or elevated credenza
- Is Shared between two users
- Features:
  - An angled display shelf
  - A closed storage section with slots for filing above
- Non handed

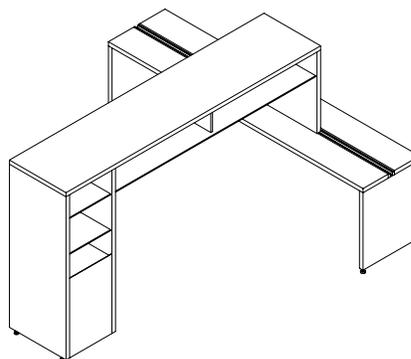

### Storage - Single Sided

- Mounts to a stage or elevated credenza
- Singled sided
- Features:
  - Open shelves
  - A closed storage section
  - Left or right handed

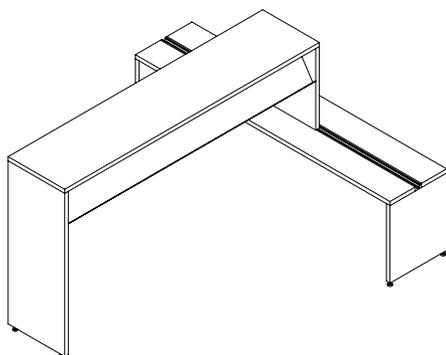

### Solid Gable - Shared

- Mounts to a stage or elevated credenza
- Shared between two users
- Features
  - An angled display shelf
  - An end gable
- Non handed

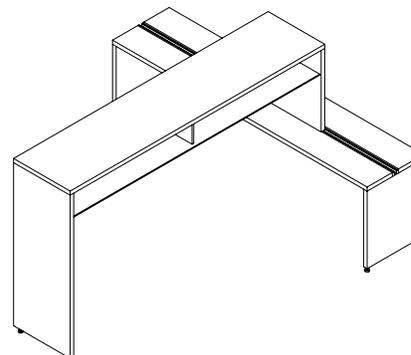

### Solid Gable - Single Sided

- Mounts to a stage or elevated credenza
- Singled sided
- Features:
  - Open shelves
  - An end gable
- Non handed

## handedness

Single Sided and Solid Gable Single Sided handedness is determined by the open space as viewed by the user.

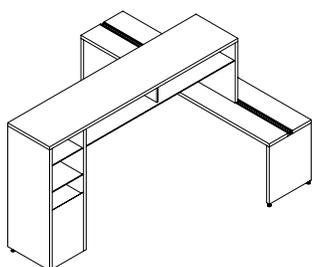

Shared Storage - Left

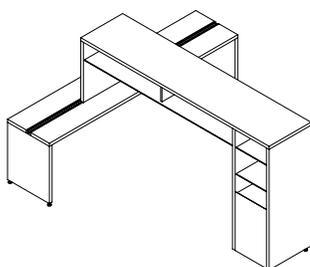

Shared Storage - Right

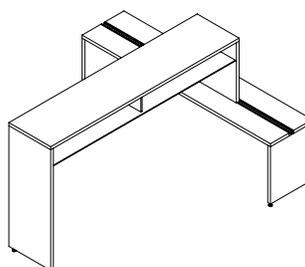

Solid Gable - Left

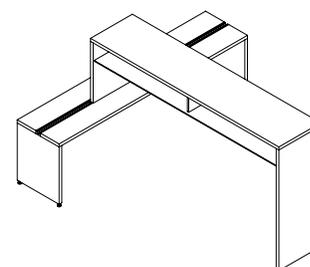

Solid Gable - Right

## planning with lateral towers (continued)

The following should be considered when planning with lateral towers.

### lateral towers with single and shared storage

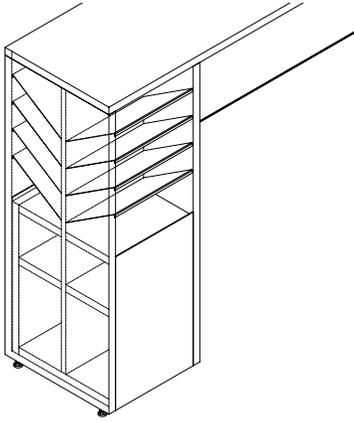

#### Shared Storage

- The shelves and lower closed storage have a mid divider with storage on each side

(Note: image for visualization purposes, is shown without an end gable)

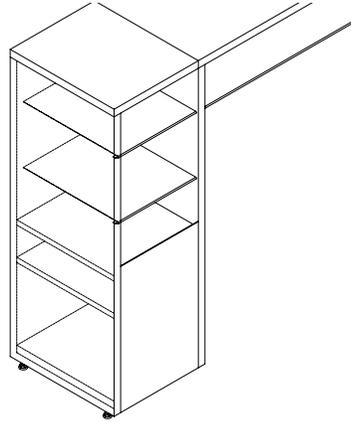

#### Single-Sided Storage

- The shelves and lower closed storage have a back with storage facing the user

(Note: image for visualization purposes, is shown without an end gable)

### mounting lateral towers

Lateral towers mount to a stage or to 21" h storage.

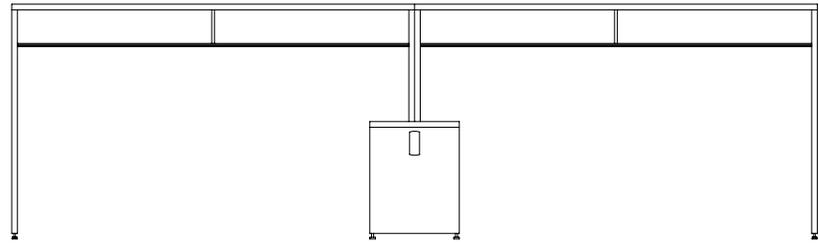
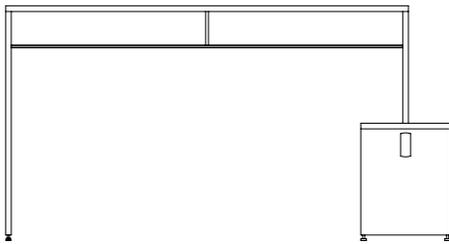

#### Stages

- When mounting to a stage the lateral tower the inside gable will connect to the accessory beam
- Towers can be mounted on one or both sides of the stage

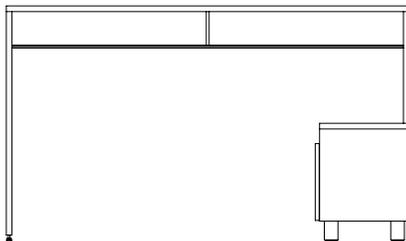

- When mounting to a credenza the lateral tower the inside gable will connect mount to the back of the credenza

- Towers can mount to upStage or District credenzas



# planning with lateral towers (continued)

## lateral tower datum heights

Lateral Towers are at 42" high provide a perch for impromptu collaboration or seated height divisional privacy.

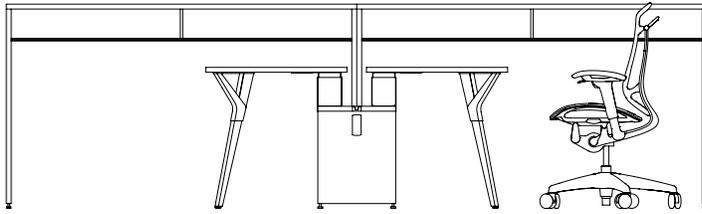

Standing Height

Seated Height

Single sided and shared lateral towers do not have same clearance from the worksurface to the underside of the storage on the lateral tower

- Single sided applications 5"
- Shared 3"

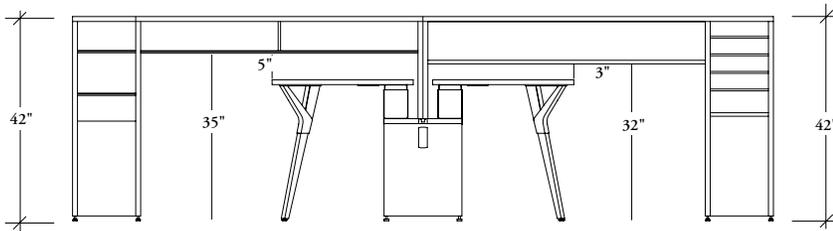

Lateral Tower - Single Sided

Lateral Tower - Shared

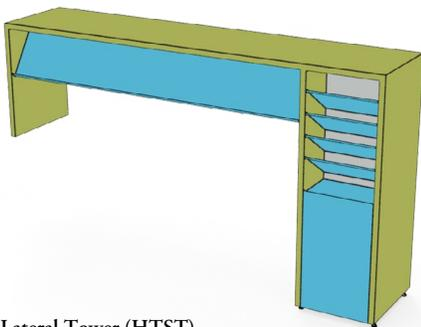

Lateral Tower (HTST)

- Outer Case Finish
- Inner Case Finish
- Accent Metal

Outer Case Finish	Inner Case Finish
Source Laminate	Source Laminate
Flintwood	Flintwood
Veneer 2 & 3	Veneer 2 & 3

- Metal Finish:
- Foundation
- Mica
- Accent

## side filer & mini side filer basics

The following outlines the features of upStage Side Filer and Mini Side Filers.

Side Filers have a pull out storage door provide personal storage and divisional privacy.

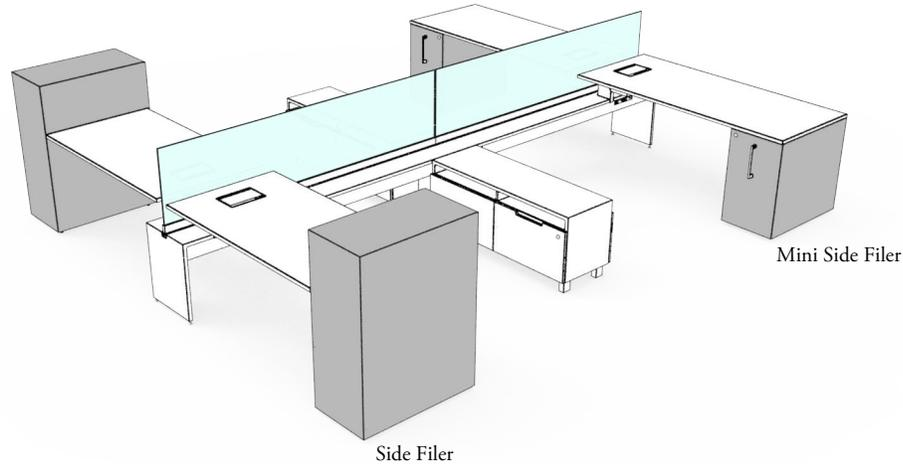

- Side Filers are available in two formats:
  - Side Filer -provides storage and privacy
  - Mini Side Filers - provide undersurface storage
- Width: 16"
- a variety of accessory and wardrobe options are available

- Front Face and Case and Interior finish:
  - Laminate
  - Flintwood
  - Natural Veneer
- Interior Metal and Pull Handle finish:
  - Foundation
  - Mica
  - Accent

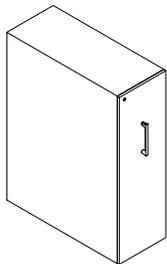

### Side Filer (HTSFT)

- Heights: 42" and 51"
- Depths: 24" , 30" and 36"
- Applications:
  - With fixed height tables
  - With height adjustable tables
  - Freestanding
- Leveling Range:
  - fixed levelers with no range, the unit is supported with a caster when extended
- Locks: Standard
  - Digital lock options available
- Configurations:
  - (N) No Accessories, with Wardrobe
  - (A) Accessory Bundle A, with Wardrobe
  - (B) Accessory Bundle B, with Wardrobe
  - (K) No Accessories, No Wardrobe
  - (M) Accessory Bundle A, No Wardrobe
  - (P) Accessory Bundle B, No Wardrobe
- USB Options:
  - (N) No USB
  - (S) Grommet on the Side
  - (B) Grommet on the Bottom

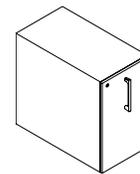

### Mini Side Filer (HTSFS)

- Height: 28"
- Depths: 23" and 29"
- Provides support to a worksurface
- Leveling Range is 0.5" to +2.5"
- Configurations:
  - (N) No Accessories
  - (A) Accessory Bundle A
  - (B) Accessory Bundle B
- USB option
- Locks: Standard
  - Digital lock options available

# planning with side filers & mini side filers

## interior configurations

All Side Filers and Mini Side Filers are complete with accessory shelves, rails, bag drop area and the option for a wardrobe and accessory bundles. The storage area will vary depending on the depth and configuration selected.

### 42" High Side Filer

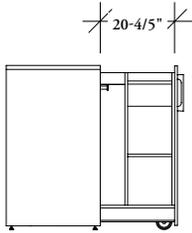

- 24" deep Side Filer**
- 20 4/5" extension
  - Option with coat storage, accessory storage and bag drop

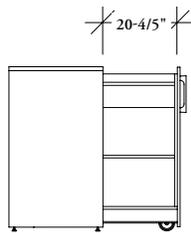

- 24" deep Side Filer**
- 20 4/5" extension
  - Option with accessory storage and bag drop

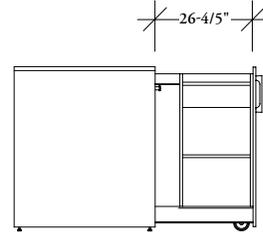

- 30" or 36" deep Side Filer**
- 26 4/5" extension
  - Option includes coat storage, accessory storage and bag drop

### 51" High Side Filer

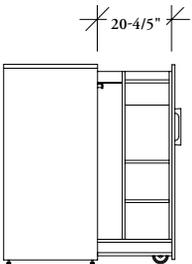

- 24" deep Side Filer**
- 20 4/5" extension
  - Option with coat storage, accessory storage and bag drop

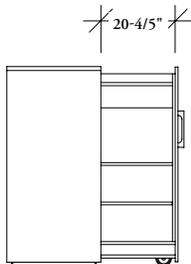

- 24" deep Side Filer**
- 20 4/5" extension
  - Option with accessory storage and bag drop

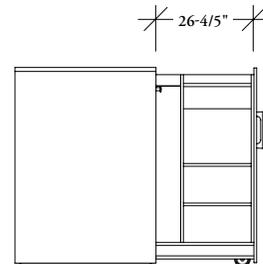

- 30" or 36" deep Side Filer**
- 26 4/5" extension
  - Option includes coat storage, accessory storage and bag drop

### 28" High Mini Side Filer

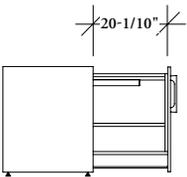

- 23" deep Side Filer**
- 20 1/10" extension
  - Option with accessory storage and bag drop

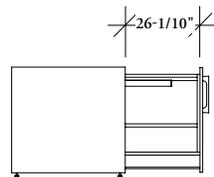

- 29" deep Mini Side Filer**
- 26 1/10" extension
  - Option includes accessory storage and bag drop

## handedness

Handedness is determined by the location of the Side Filer and Mini Side Filer in relation to the user.

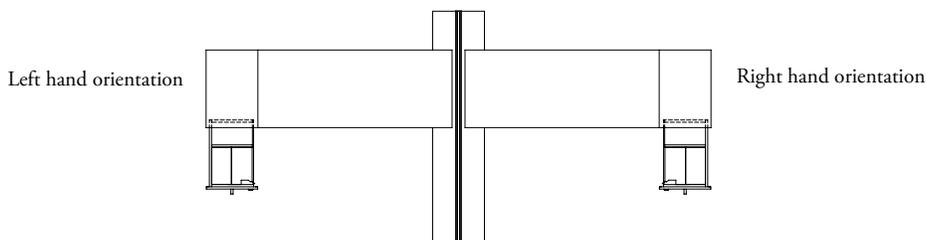

## planning with side filers

The following should be considered when planning with upStage Side Filers.

Side Filers can be planned in parallel and perpendicular applications.

### parallel planning

#### 30" deep worksurface

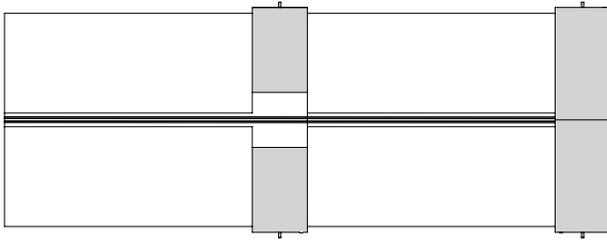

- Can be planned with a 24" or 30" deep side filer
  - 24" deep is used in the middle of a run and will sit against the stage
  - 30" deep is used at the end of a stage run, and can be planned back to back

#### 36" deep worksurface

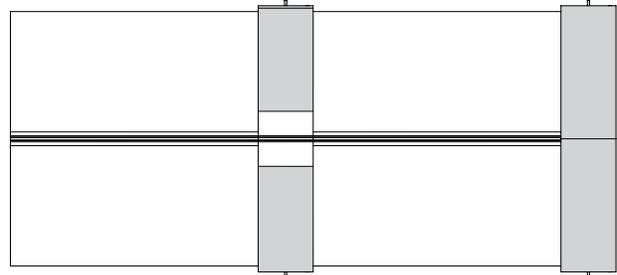

- Can be planned with a 30" or 36" deep Side Filer
  - 30" deep is used in the middle of a run and will sit against the stage
  - 36" deep is used at the end of a stage run, and can be planned back to back

### perpendicular planning

In perpendicular applications, the Side Filer will match the depth of the worksurface.

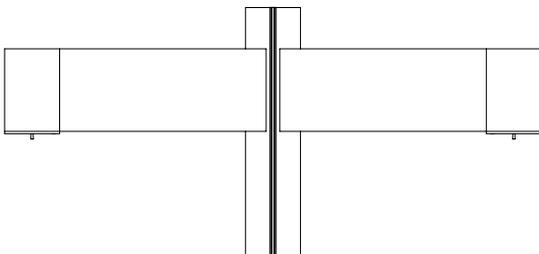

Perpendicular 24" deep worksurface

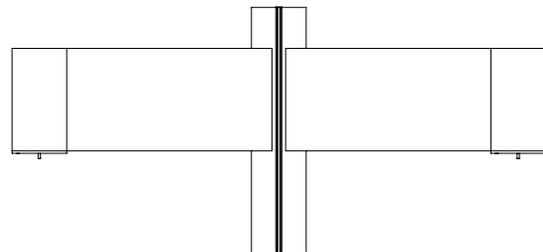

Perpendicular 30" deep worksurface

# planning with mini side filers

The following should be considered when planning with Mini Side Filers.

- Mini Side Filers can be planned in parallel and perpendicular applications
  - worksurface supporting

## parallel planning

### 30" deep worksurface

- If planned below the worksurface must be one depth smaller than the worksurface
  - 24" d. is used on a 30" worksurface
  - 30" d. is used on a 36" worksurface

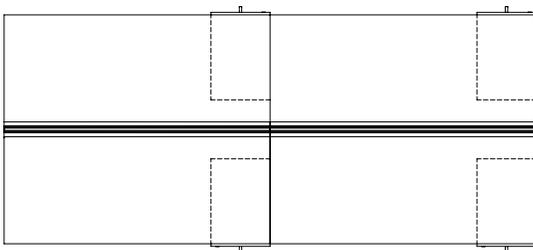

Parallel 30" deep worksurface

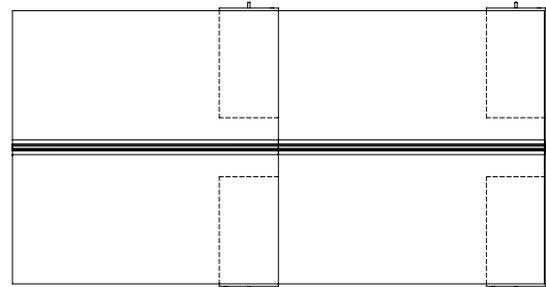

Parallel 36" deep worksurface

## perpendicular planning with side filers

### 24" and then 30" deep worksurface

- Mini Side Filers are worksurface supporting:
  - The Mini Filer must be the same depth as the worksurface

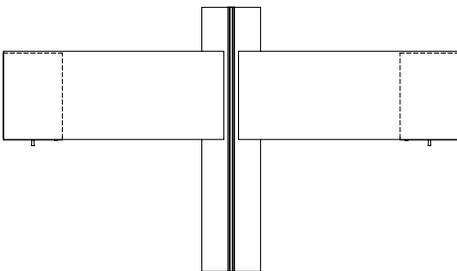

Perpendicular 24" deep worksurface

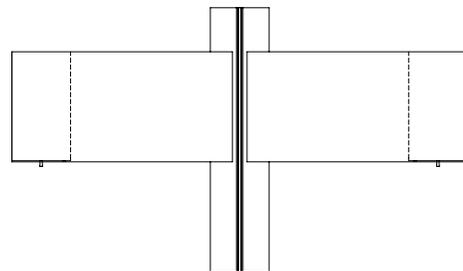

Perpendicular 30" deep worksurface

## planning with side filer, mini side filer & usb power

The following should be considered when planning with Side Filers and USB Power.

The optional USB add-on provides two USB-A ports in the pocket drop area to allow for the charging of USB powered devices.

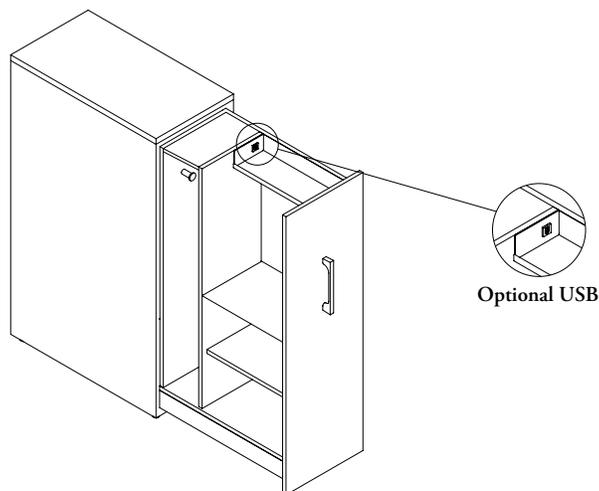

### power cord locations

- The power location can be specified in these locations:
  - Bottom (Side Filer only)
  - Right side (Side and Mini Side Filer)
  - Left side (Side and Mina Side Filer)

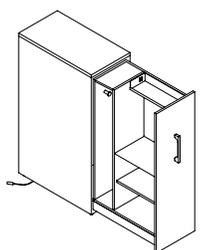

**Side Filer**  
Bottom Power Location

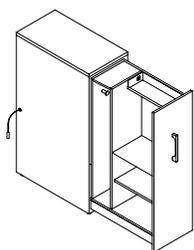

**Side Filer**  
Right Side Power Location

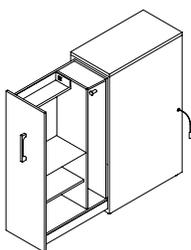

**Side Filer**  
Left Side Power Location

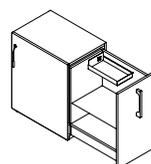

**Mini Side Filer**  
Right Side Power Location

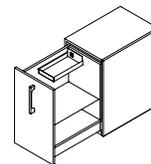

**Mini Side Filer**  
Left Side Power Location

The height from the floor to a power cord location is 25" for Side Filers and Mini Side Filers.

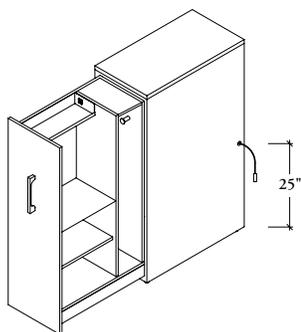

The Side Filer can be planned at least 50" from a power source.

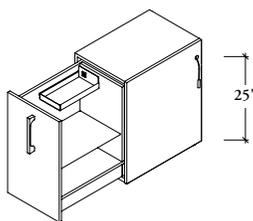

The Mini Side filer can be planned at leave 80" from a power source.

# planning with side filer, mini side filer & usb power (continued)

- When parallel planning with Side Filers , the power cord will come from the side of the Side Filer to the stage
  - This applies to both Side Filers in a run or at the end of a run

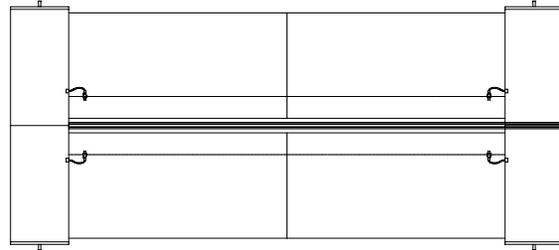
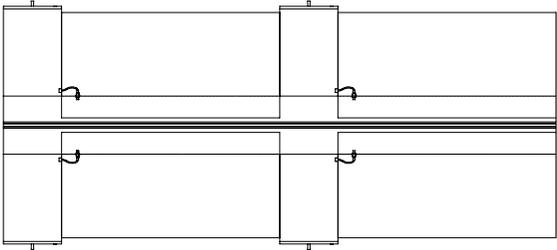

- When perpendicular planning with Side Filers, the power cord will run from the side of the Side Filer to a Power Rod, Under Worksurface Mount with Cable Tray (YEPD)
  - It is also recommended what Wire Management Clips (YESW) are specified

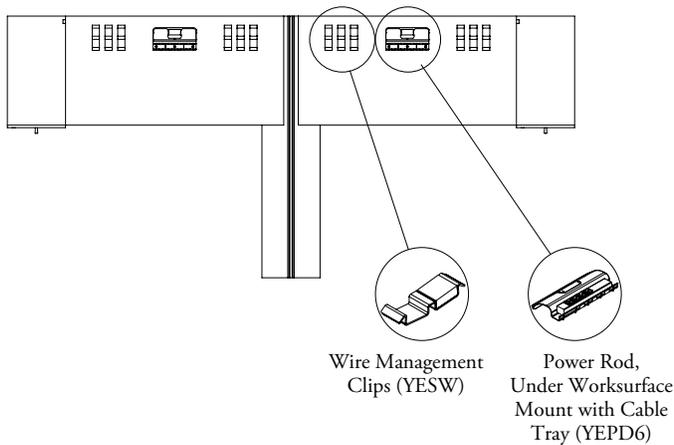

## storage cube basics

**The Storage Cube is a mobile personal storage unit that fits casually under the stage or anywhere in a workstation.**

- Storage Cubes can be used in a variety of locations:
  - Fully underneath stage
  - Protrude outside of it
  - Sit back to be back
  - Be conveniently situated anywhere under a worksurface as a freestanding storage unit

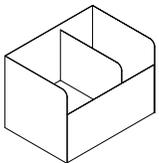
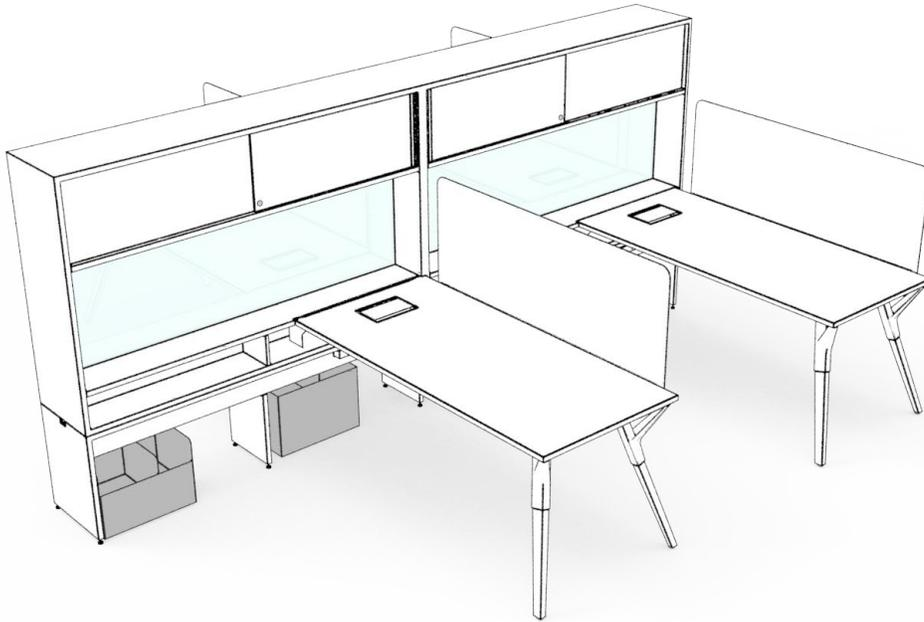

### Storage Cube (HTAB)

- Height: 15"
- Depth: 13"
- Width: 18"
- Includes a divider for optimal organization



# planning with storage cube

The following should be considered when planning with the Storage Cube.

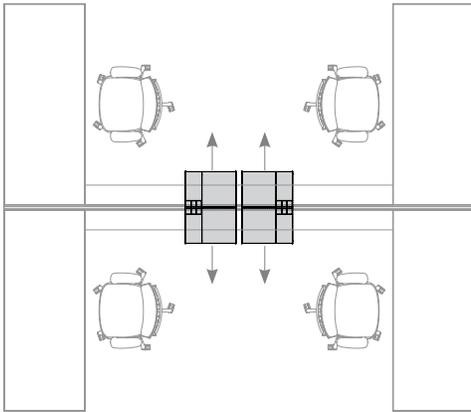

**Back-to-Back Planning**  
- Will protrude from the stage on the user side

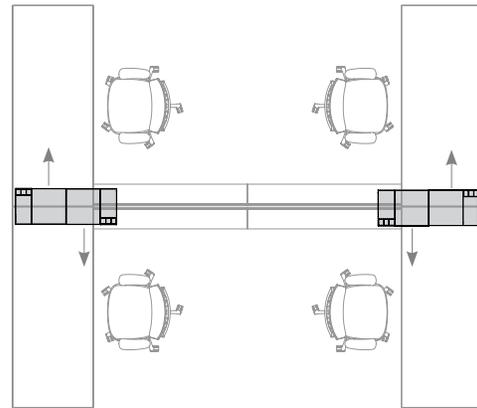

**Mirrored Planning**  
- Will fit fully under the stage

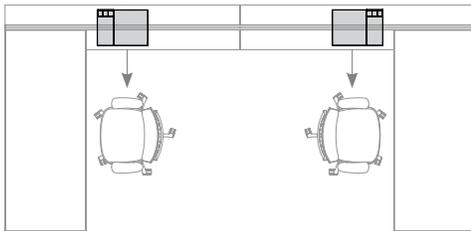

**Single Sided Planning**  
- Will fit fully under the stage

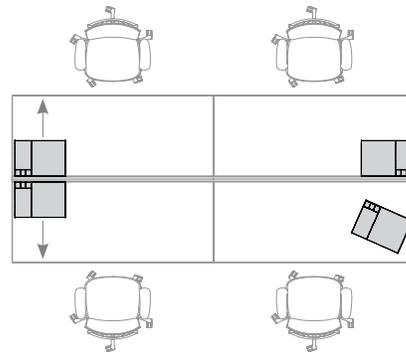

**Parallel Back-to-Back Planning**  
- Will fit fully under the stage

upStage offers an extensive finish offering to allow a user to create their own unique look.

## Storage Cube (HTAB)

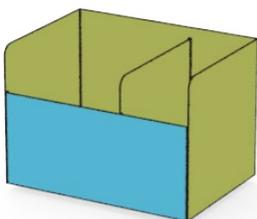

- Primary Finish
- Secondary Finish

Primary Finish	Secondary Finish	Base Finish
Foundation Mica Accent Colors	Foundation Mica Accent Colors	Source Laminate

storage accessories

# storage accessories

ACCESSORY BASICS . . . . .	204
PLANNING WITH ACCESSORIES . . . . .	205
STORAGE FASCIA ADD-ON BASICS . . . . .	208
PLANNING WITH STORAGE FASCIA ADD-ON . . . . .	209
ACCESSORY BUNDLE BASICS . . . . .	210
PLANNING WITH ACCESSORY BUNDLES . . . . .	211
HUTCH STACKER LOCK CHART . . . . .	212
CREDENZA LOCK CHART . . . . .	213
HINGED DOOR STACKER LOCK CHART . . . . .	216
LOCKER LOCK CHART . . . . .	217
GRAIN DIRECTION . . . . .	218
DRAWER & OPENING SIZING CHART . . . . .	221
FILING CAPABILITIES . . . . .	228

## accessory basics

upStage accessories add functionality and the ability to add a personal touch to a workstation.

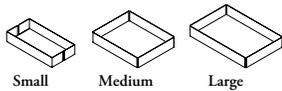
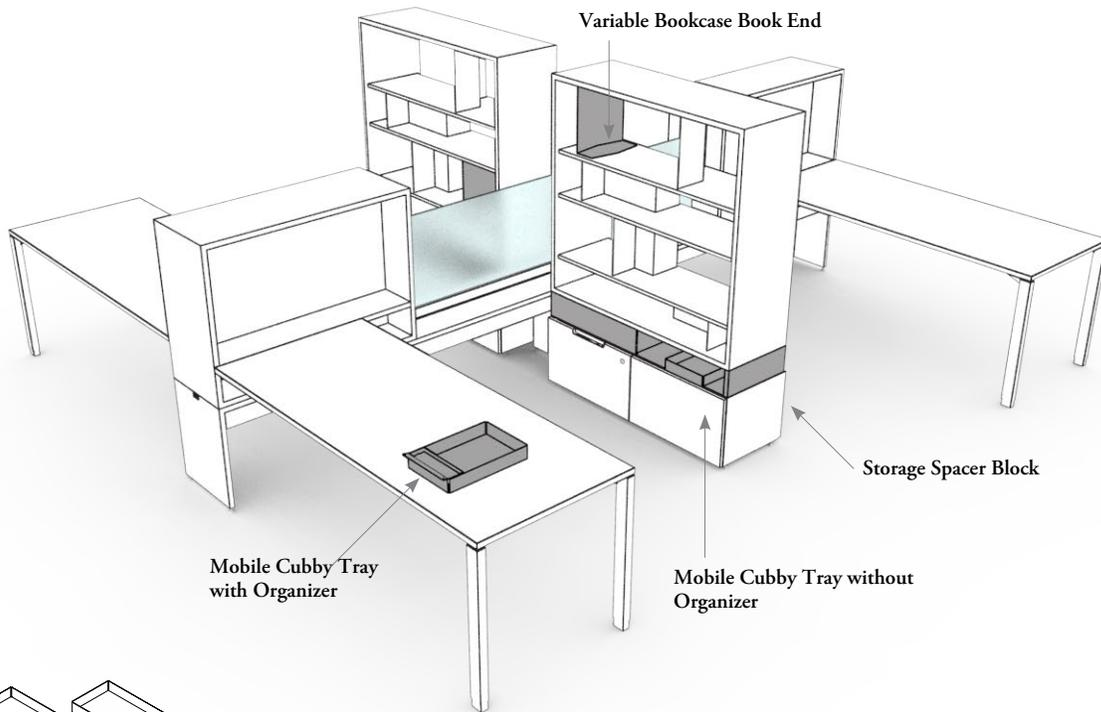

### Mobile Cubby Tray (HTAT)

- Trays fit into the cubbies of hutches and stackers to provide additional storage
- Configurations:
  - Small
  - Medium
  - Large
- Includes a textured fabric liner to cushion stored items
- Optional Mini Tray Organizer available
- Finishes:
  - Foundation
  - Mica
  - Accent



### Mini Tray Organizer (HTAG)

- Used with a variety of storage units to provide organization
- Heights: 12", 14"
- Finishes:
  - Foundation
  - Mica
  - Accent



### Variable Bookcase Bookend (HTAD)

- Used with a variety of storage units to provide organization
- Heights: 12", 14"
- Finishes:
  - Foundation
  - Mica
  - Accent

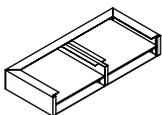

### Stage Spacer Block (HTAS)

- Used between a Stage Credenza and stacking hutches and storage to elevate the credenza height to the standard 21"h datum height
- Widths: 24" - 48" w. in 6" increments
- Configurations:
  - Single
  - Shared (24"w. not available)
- Finishes:
  - Foundation
  - Mica
  - Accent

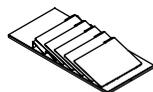

### Horizontal Filing Insert (HTAF)

- Provides casual filing storage inside a box drawer
- Options:
  - Ordered as an option with the cabinet (finish will default to the drawer finish)
  - Order separately
- Widths: 16", 18", 21", 24" and 30"w
- Finishes:
  - Foundation
  - Mica
  - Accent

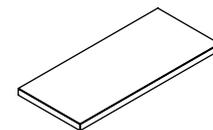

### Cushion (HTAC)

- Provides additional seating on a stage or credenza
- Widths: 24" - 48" in 6" increments
- Fabrics:
  - All Teknion Seating fabrics

# planning with accessories

The following should be considered when planning with upStage Accessories.

## bookend

- Bookends can be used with a variety of upStage storage units
  - Short: 12"h
    - Used on the Variable Bookcase lower shelf
  - Tall: 14"
    - Used on the Variable Bookcase upper shelf and all bookcases

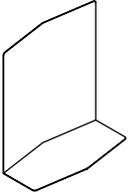

## cushion

- Cushions can be used on stages or credenzas
- Not for use on a Mobile Pedestal
  - Mobile pedestals have a unique cushion which is ordered as an option on the pedestal

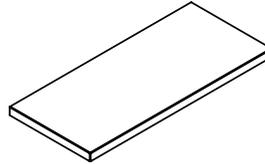

## stage spacer block

- Attaches to the underside of a stacker
- Must be the same width as the stacker

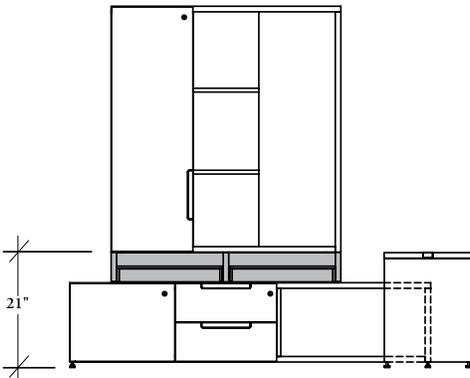

# planning with accessories (continued)

## horizontal filing insert (HTAF)

- Provides casual filing storage in Box/Box drawers
- Available in 16", 18", 21" 24" and 30" widths
- Can be specified as an option when ordering Credenzas with Box/Box drawers
- When ordered as an option within Credenzas, File divider finish specified drawer handle finish and bottom liner is defaulted to the interior of the drawer

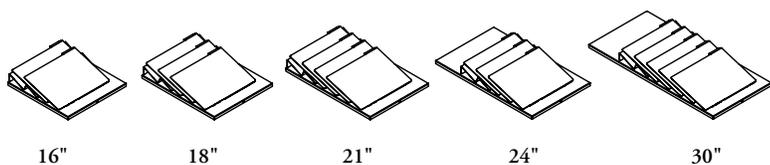

- The depth of the Horizontal Filing Insert is dependent on the size of the storage it is used in
- Can only be used in box drawers, and not file drawers
- Inserts mount horizontally into a box drawer

Storage Width		30"	36"	42"	48"
Stage Double Credenza (HTSCW)	FF	×	×	×	×
	F/BB	×	16	21	24
	F/H	×	×	×	×
	H/BB	18	21	24	30
Elevated Double Credenza (HTSCY)	BB/F	×	16	21	24
	C/F	×	×	×	×
	F/H	×	×	×	×
	C/BB	18	21	24	30
	BB/H	18	21	24	30

Storage Width		54"	60"	66"	72"
Stage Triple Credenza (HTSCZ)	F/BB/H	18	18	18	21
	F/BB/C	18	21	24	24
	C/F/H	×	×	×	×
	C/BB/H	18	18	18	24
Elevated Triple Credenza (HTSCX)	C/BB/F	18	18	18	21
	C/F/H	18	21	24	24
	F/H	×	×	×	×
	C/BB/H	18	18	18	24

## planning with accessories (continued)

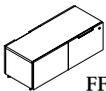
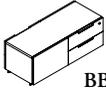
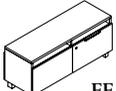
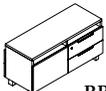
Storage Width		30"	36"	42"	48"
Stage Shared Double Credenza (HTSCU)	 FF	×	×	×	×
	 BB	×	×	21	24
Elevated Shared Double Credenza (HTSCR)	 FF	×	×	×	×
	 BB	×	×	21	24

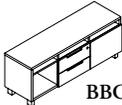
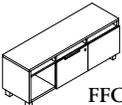
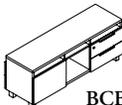
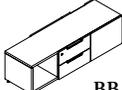
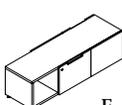
Storage Width		54"	60"	66"	72"
Elevated Shared Triple Credenza (HTSCQ)	 BBC	18	18	21	21
	 FFC	×	×	×	×
	 BCB	18	21	21	24
	 FCF	×	×	×	×
Stage Shared Triple Credenza (HTSCV)	 BB	18	21	24	24
	 F	×	×	×	×

## storage fascia add-on basics

upStage Fascia Add-Ons add functionality to bookcases and stackers with hinged doors.

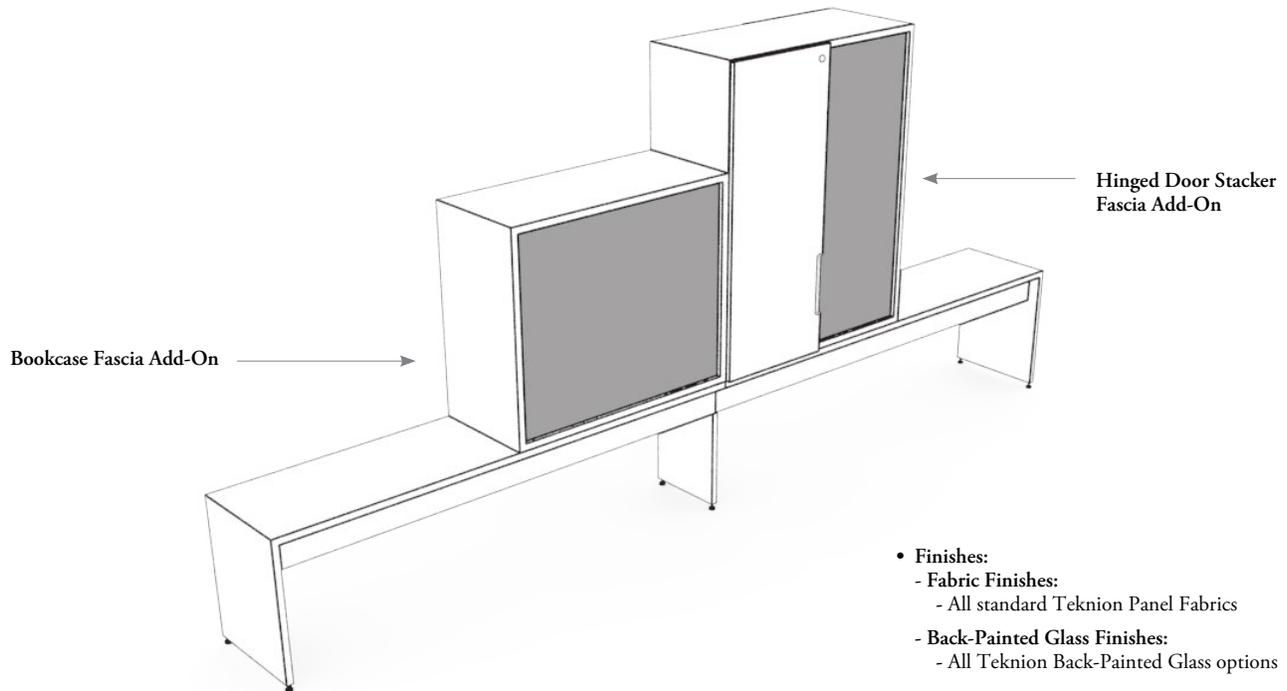

- **Finishes:**
  - **Fabric Finishes:**
    - All standard Teknion Panel Fabrics
  - **Back-Painted Glass Finishes:**
    - All Teknion Back-Painted Glass options

- Fascias mount to the outside back of a storage unit
- **Styles**
  - Whiteboard
  - Fabric
  - Backpainted glass
- Fascias match the height of the stacker

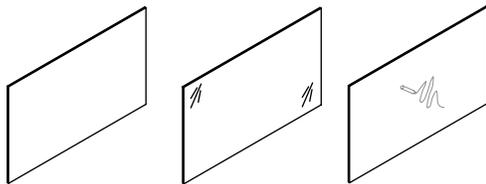

### Bookcase Fascia Add-On (HTAN)

- Widths: 30" - 72" in 6" increments
- **Applications:**
  - Single sided
  - Single sided with open through top
  - Shared
  - Shared with open through top

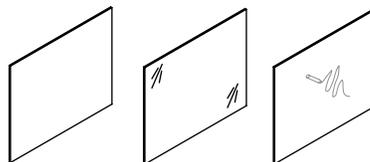

### Hinged Door Stacker Fascia Add-On (HTAZ)

- Widths:  $\leq$ 30" - 48" in 6" increments
- **Applications:**
    - Single sided
    - Shared



# planning with storage fascia add-on

The following should be considered when planning with Storage Fascia Add-Ons.

- Fascias are inset into the frame on the back of a bookcase or stacker
- Widths are nominal and specified the same width as the storage
  - In shared applications one fascia needs to be ordered for each side

## Bookcase Stacker Fascia Add-On (HTAN)

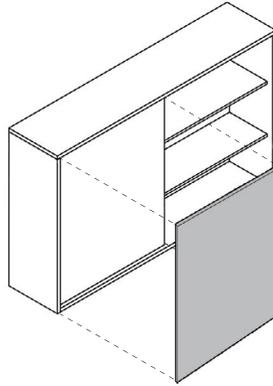
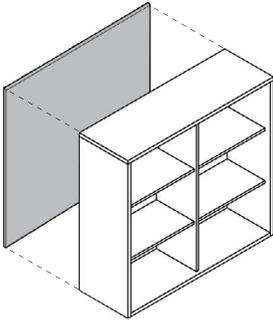

cannot be used with bookcases with sliding doors

- In shared applications the fascia is specified the full width of the bookcase even though it only covers one backside of the bookcase

## Hinged Door Stacker Fascia Add-On (HTAZ)

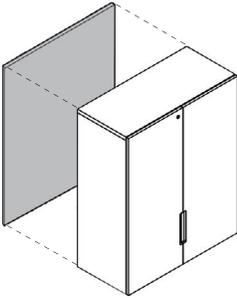

## accessory bundle basics

upStage accessories and accessory bundles provide organization to the inside of a Side Filer or Mini Sider Filer.

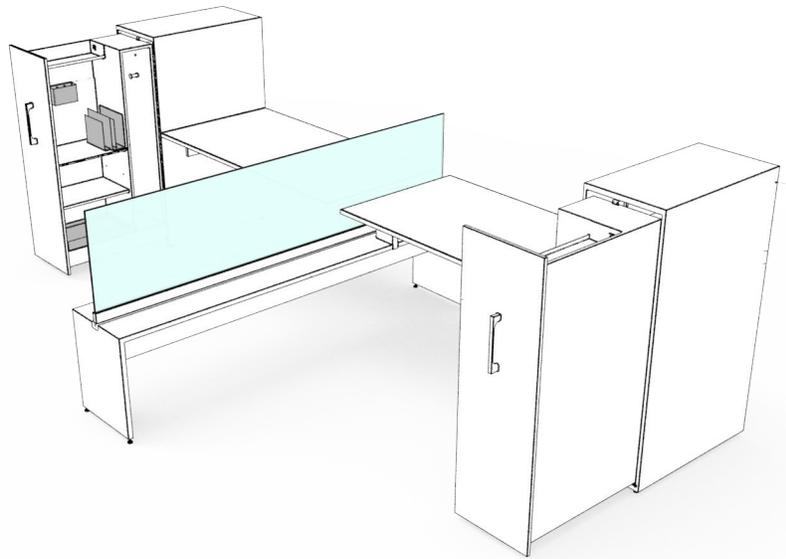

- Paint Finishes:
- Foundation
  - Mica
  - Accent

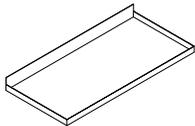

### Boot Tray (HTAR)

- Provides storage for shoes and boots
- Sits on the bottom shelf of a Side Filer or Mini Side Filer
- Depth: 13"
- Widths:
  - 12" w - used with a 24" d and 32" d Side Filer
  - 18" w - used with a 30" d and 38" d Side Filer
  - 20" w - used with a 24" d Side Filer without coat storage
  - used with a 23" d Mini Side Filer
  - 26" w - used with a 2" d Mini Side Filer

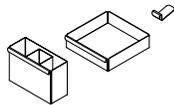

- Bundle A includes:**
- Hanging Pen Pocket
  - Hanging Tray
  - Headphone Hook

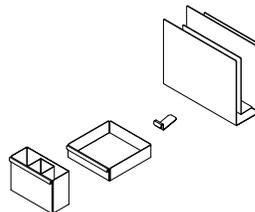

- Bundle B includes:**
- Hanging Pen Pocket
  - Hanging Tray
  - Headphone Hook
  - Paper Filer

### Accessory Bundles (HTAK)

- Provide storage inside of a Side Filer or Mini Side Filer
- Can be specified two ways:
  - As an option to the Side Filer or Mini Side Filer
    - The finish will default to the finish of the cabinet interior
  - Individually
    - All finishes available and can be different than the interior of the cabinet interior
- Configurations:
  - Bundle A
  - Bundle B

# planning with accessory bundles

The following storage components are included in Accessory Bundles



**Hanging Pen Pocket**

- Provides storage for pens, pencils, markers and scissors
- Attaches to the accessory rail

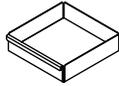

**Hanging Tray**

- Provides storage for small office accessories
- Attaches to the accessory rail



**Headphone Hook**

- Provides storage for standard headphones
- Attaches to the hanging tray or accessory rail

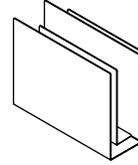

**Paper Filer**

- Accommodates file folders, books and papers
- Designed to sit on bottom shelf

# hutch stacker lock chart

## Open Through Hutch Stacker with Sliding Door Overhead (HTSHNK)

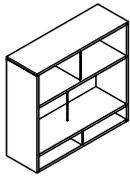

Single  
1 Lock

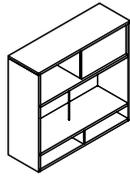

Shared  
2 Locks

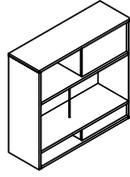

Aperture  
2 Locks

---

## Solid Back Hutch Stacker with Sliding Door Overhead (HTSHSK)

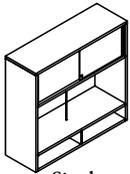

Single  
1 Lock

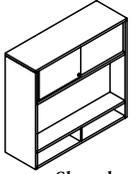

Shared  
2 Locks

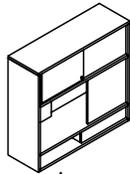

Aperture  
2 Locks

---

## Glass Back Hutch Stacker with Sliding Door Overhead (HTSHGK)

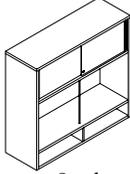

Single  
1 Lock



Shared  
2 Locks

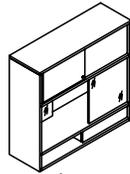

Aperture  
2 Locks

---

## Perforated Hutch Stacker with Sliding Door Overhead (HTSHPK)

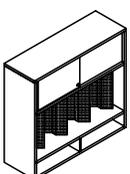

Shared  
2 Locks

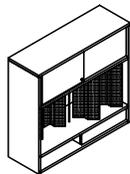

Aperture  
2 Locks

---

## Elevated Hutch Stacker (HTSHE)

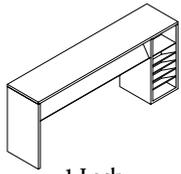

1 Lock

---

# credenza lock chart

## Stage Single Credenza (HTSCJ)

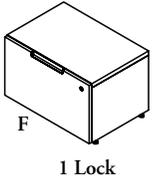

## Stage Double Credenza (HTSCW)

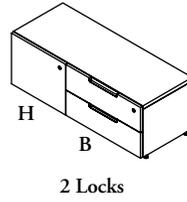
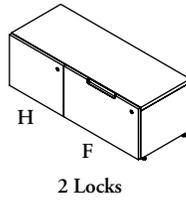
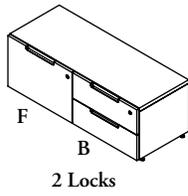
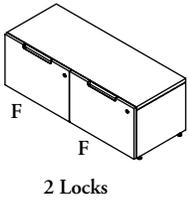

## Stage Triple Credenza (HTSCZ)

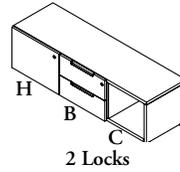
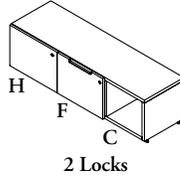
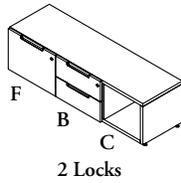
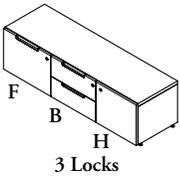

## Mobile Pedestals (HTSM)

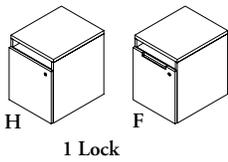

## Elevated Double Credenza (HTSCY)

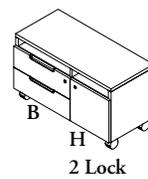
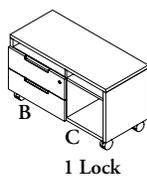
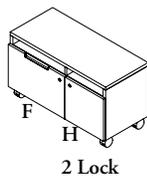
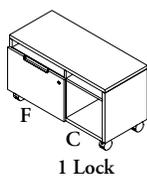
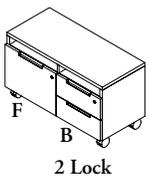

# application guide

---

## credenza lock chart (continued)

### Elevated Triple Credenza (HTSCX)

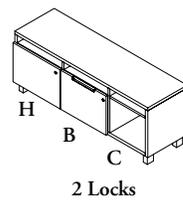
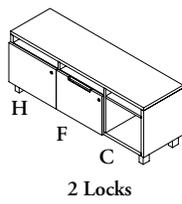
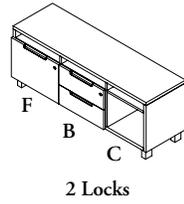
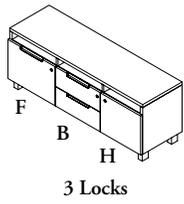

### Stage Shared Double Credenza (HTSCU)

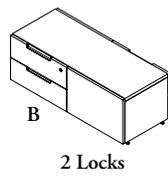
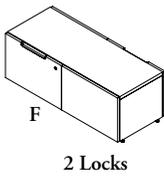

### Stage Shared Triple Credenza (HTSCV)

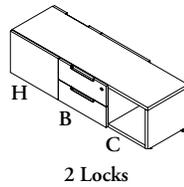
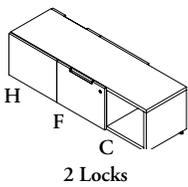

### Elevated Shared Double Credenza (HTSCR)

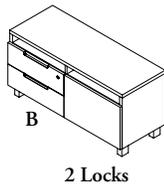
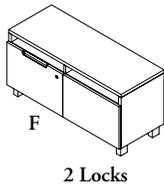

### Elevated Shared Triple Credenza (HTSCQ)

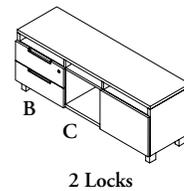
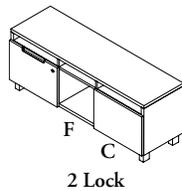
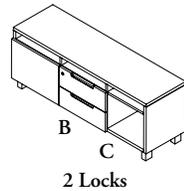
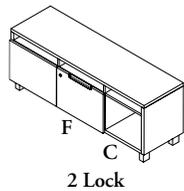

# credenza lock chart (continued)

## Double Credenza for Height-Adjustable Table (HTSCC)

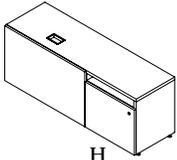

H  
1 Locks

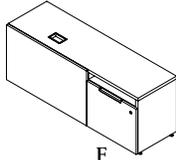

F  
1 Locks

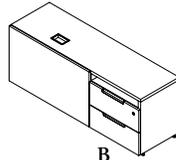

B  
1 Locks

## Triple Credenza for Height-Adjustable Table (HTSCT)

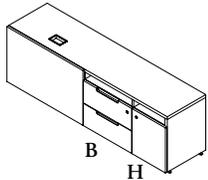

B H  
2 Locks

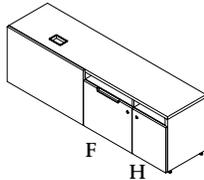

F H  
2 Locks

# hinged door stacker lock chart

## Single Hinged Door Stacker (HTSSS)

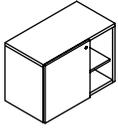

Open with Cubbies  
1 Lock

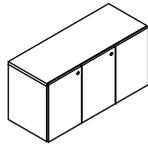

All Closed  
2 Locks

---

## Shared Hinged Door Stacker (HTSSD)

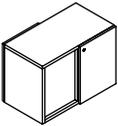

2 Locks

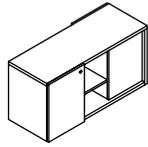

2 Locks

---

## Single Writeable Hinged Door Stacker (HTSSG)

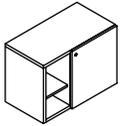

Open with Cubbies  
1 Lock

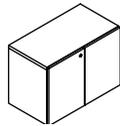

All Closed  
1 Lock

---

## Shared Writeable Hinged Door Stacker (HTSSP)

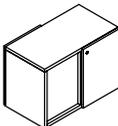

2 Locks

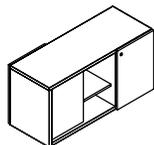

2 Locks



# locker lock chart

## Lockers (HTSL)

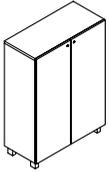

Dual, Push Latch  
2 Locks

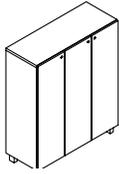

Triple, Push Latch  
3 Locks



Quad, Push Latch  
4 Locks

## Cubby Lockers (HTSLC)

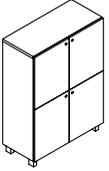

Hinged Door,  
Push Latch  
4 Locks



Hinged Door with  
Mail Slot, Push Latch  
4 Locks

## Lateral Tower (HTST)

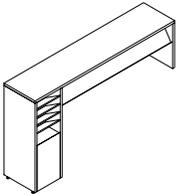

1 Lock

## Side Filer (HTSFT)

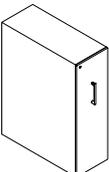

1 Lock

## Mini Side Filer (HTSFS)

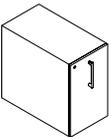

1 Lock

## grain direction

The following outlines the grain direction of a upStage storage units.

### stage credenza

#### Fronts

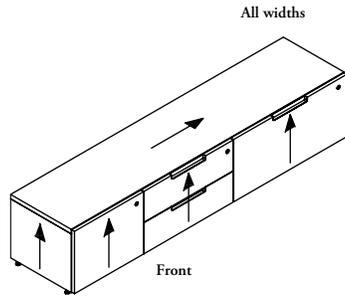

Laminate, Veneer & Flintwood

#### Backs

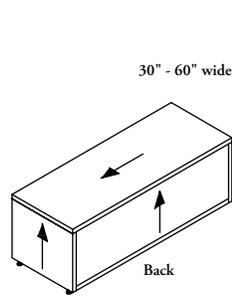

Laminate

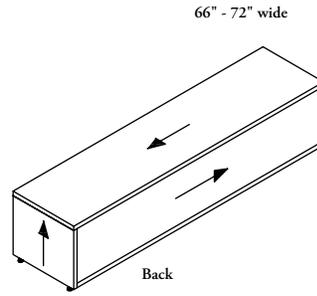

Laminate

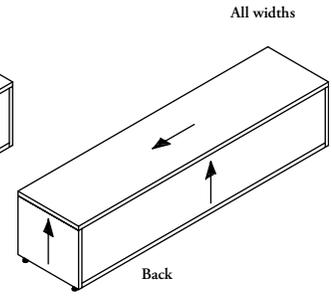

Veneer & Flintwood

### elevated credenza

#### Fronts

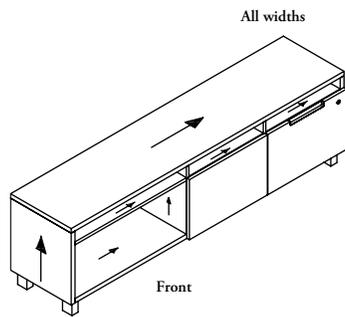

Laminate, Veneer & Flintwood

#### Backs

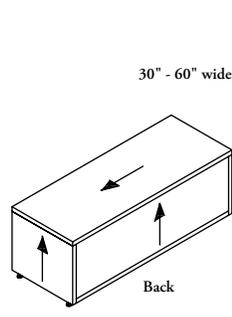

Laminate

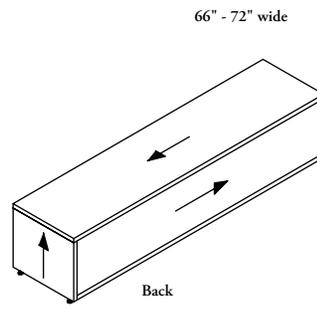

Laminate

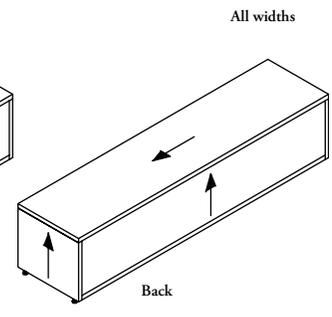

Veneer & Flintwood

### stage single credenza

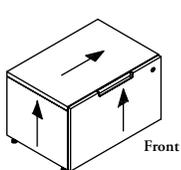

Laminate, Veneer & Flintwood

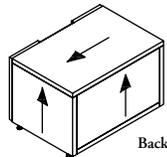

Laminate, Veneer & Flintwood

# grain direction (continued)

## credenzas for height-adjustable tables

Fronts

Backs

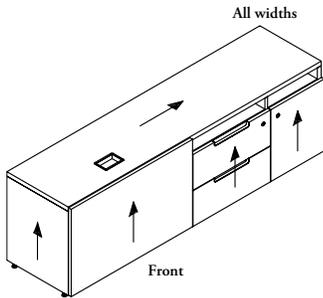

Laminate, Veneer & Flintwood

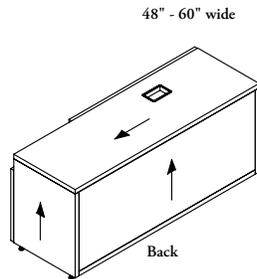

Laminate

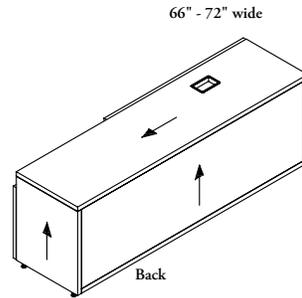

Laminate

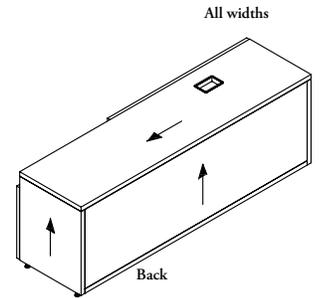

Veneer & Flintwood

## Laminate and Veneer

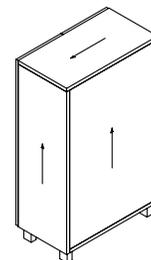
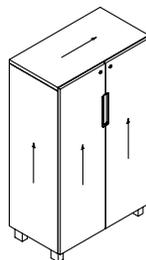
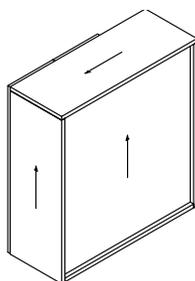
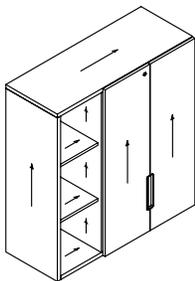
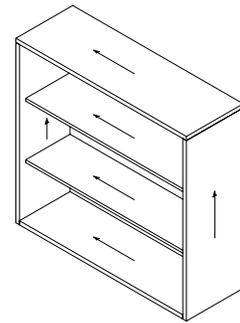
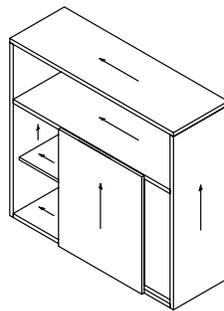
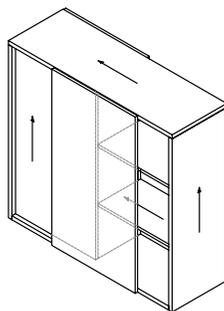
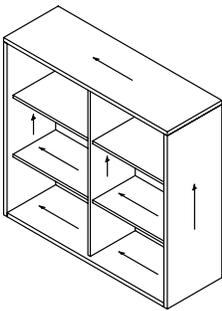

grain direction (continued)

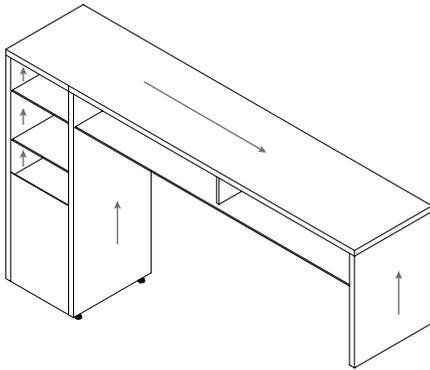

Single

Shared

Aperture

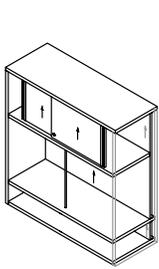

30" - 60" widths

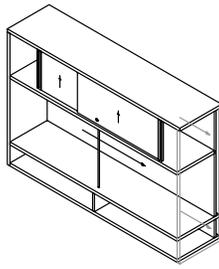

66" - 72" widths

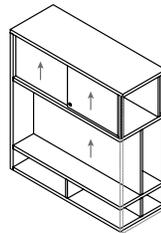

30" - 60" widths

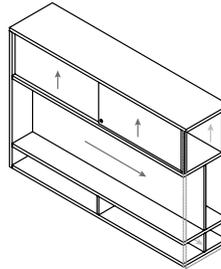

66" - 72" widths

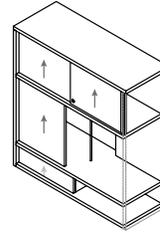

30" - 72" widths

# drawer & opening sizing chart

## single-sided stage credenzas

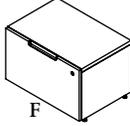
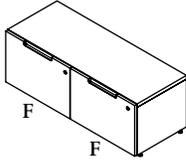
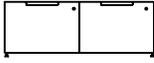
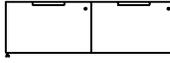
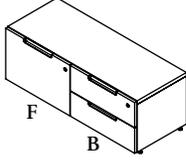
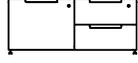
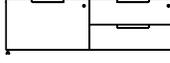
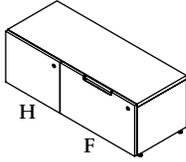
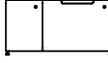
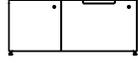
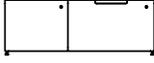
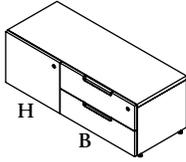
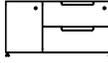
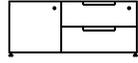
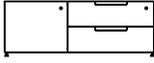
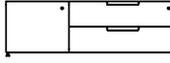
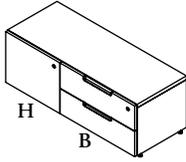
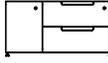
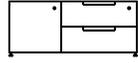
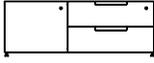
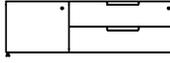
		24"	30"	36"	42"	48"
<b>Stage Single Credenza (HTSCJ)</b> One opening widths 24", 30", 36" height 15.5"		 24"	 30"	 36"		
					 21" 21"	 24" 24"
<b>Stage Double Credenza (HTSCW)</b> Two opening widths 30", 36", 42", 48" height 15.5"				 18" 16"	 21" 21"	 24" 24"
			 12" 18"	 15" 21"	 18" 24"	 18" 30"
			 12" 18"	 15" 21"	 18" 24"	 18" 30"
			 12" 18"	 15" 21"	 18" 24"	 18" 30"

# drawer & opening sizing chart (continued)

The following outlines the configurations and sizes available for stage filing.

## single-sided stage credenzas

		54"	60"	66"	72"
<p><b>Stage Triple Credenza (HTSCZ)</b>                      Three opening widths 54" - 72" (6" increments)                      height 15.5"</p>		 18.5" 18.5" 17"	 18.5" 18.5" 23"	 24" 24" 18"	 30" 24" 18"
		 18.5" 18.5" 17"	 18.5" 18.5" 23"	 18.5" 18.5" 29"	 21" 21" 30"
		 18.5" 18.5" 17"	 18.5" 18.5" 23"	 18.5" 18.5" 29"	 18.5" 24" 29.5"
		 18.5" 18.5" 17"	 18.5" 18.5" 23"	 18.5" 18.5" 29"	 18.5" 24" 29.5"

# drawer & opening sizing chart (continued)

## single-sided elevated credenzas

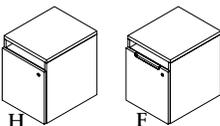
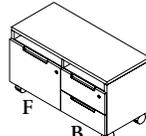
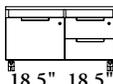
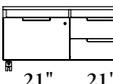
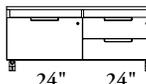
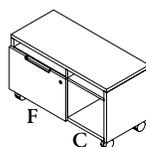
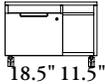
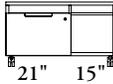
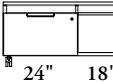
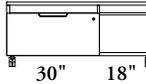
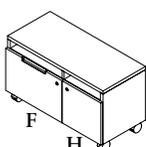
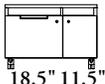
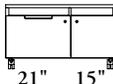
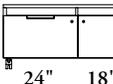
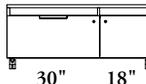
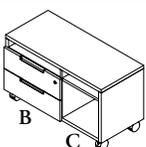
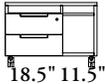
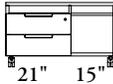
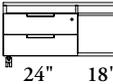
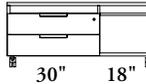
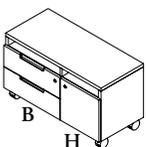
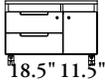
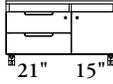
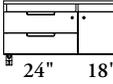
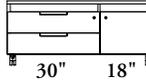
		16"	30"	36"	42"	48"
<b>Mobile Pedestals (HTSM)</b> widths 16" depth 19" height 21"	 H F	 16"				
<b>Elevated Double Credenza (HTSCY)</b> widths 30" - 48" (6" increments) height 21"	 F B			 18.5" 18.5"	 21" 21"	 24" 24"
	 F C		 18.5" 11.5"	 21" 15"	 24" 18"	 30" 18"
	 F H		 18.5" 11.5"	 21" 15"	 24" 18"	 30" 18"
	 B C		 18.5" 11.5"	 21" 15"	 24" 18"	 30" 18"
	 B H		 18.5" 11.5"	 21" 15"	 24" 18"	 30" 18"

# drawer & opening sizing chart (continued)

single-sided elevated credenzas

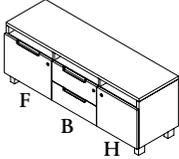
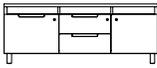
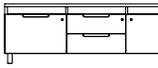
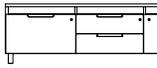
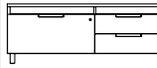
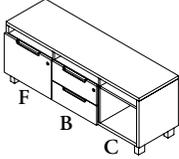
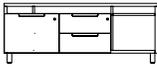
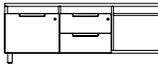
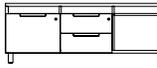
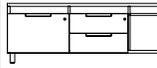
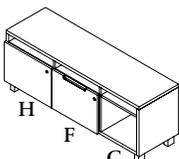
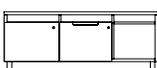
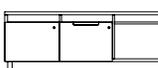
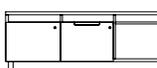
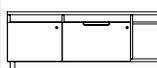
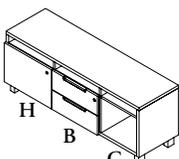
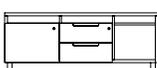
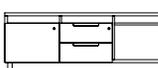
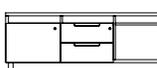
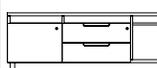
		54"	60"	66"	72"
<p><b>Elevated Triple Credenza (HTSCX)</b>                      Three opening widths 54" - 72" (6" increments)                      height 21"</p>		 18.5" 18.5" 17"	 21" 21" 18"	 24" 24" 18"	 30" 24" 18"
		 18.5" 18.5" 17"	 18.5" 18.5" 23"	 18.5" 18.5" 29"	 21" 21" 30"
		 18.5" 18.5" 17"	 18.5" 18.5" 23"	 18.5" 18.5" 29"	 18.5" 24" 29.5"
		 18.5" 18.5" 17"	 18.5" 18.5" 23"	 18.5" 18.5" 29"	 18.5" 24" 29.5"



# drawer & opening sizing chart (continued)

## shared credenzas

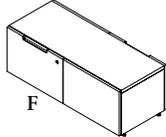
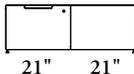
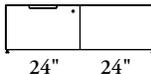
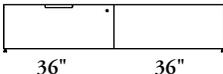
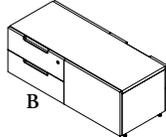
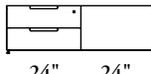
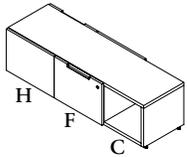
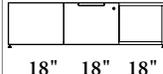
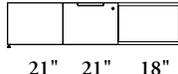
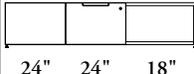
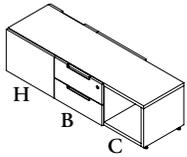
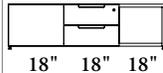
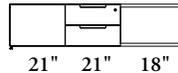
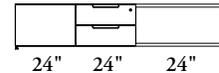
		42"	48"	60"	72"
<b>Stage Shared Double Credenza (HTSCU)</b> widths 42", 48", 60" and 72" height 15.5"	 F	 21" 21"	 24" 24"	 30" 30"	 36" 36"
	 B	 21" 21"	 24" 24"		
<b>Stage Shared Triple Credenza (HTSCV)</b> Three opening widths 54" - 72" (6" increments) height 15.5"	 H F C	 18" 18" 18"	 21" 21" 18"	 24" 24" 18"	 24" 24" 24"
	 H B C	 18" 18" 18"	 21" 21" 18"	 24" 24" 18"	 24" 24" 24"

# drawer & opening sizing chart (continued)

## shared elevated credenzas

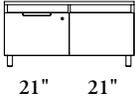
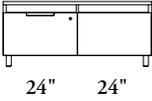
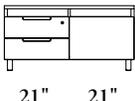
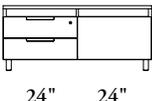
		42"	48"
<b>Elevated Shared Double Credenza (HTSCR)</b> widths 42" - 48" height 21"	F	 21" 21"	 24" 24"
	B	 21" 21"	 24" 24"

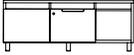
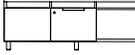
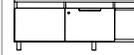
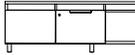
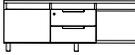
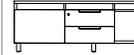
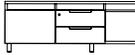
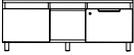
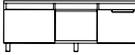
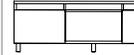
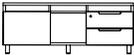
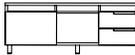
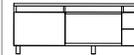
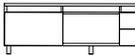
		54"	60"	66"	72"
<b>Elevated Shared Triple Credenza (HTSCQ)</b> Three opening widths 54", 60", 66", 72" height 21"	F	 18" 18" 18"	 18" 18" 24"	 21" 21" 24"	 21" 21" 30"
	C	 18" 18" 18"	 18" 18" 24"	 21" 21" 24"	 21" 21" 30"
	B	 18" 18" 18"	 21" 18" 21"	 21" 24" 21"	 24" 24" 24"
	C	 18" 18" 18"	 21" 18" 21"	 21" 24" 21"	 24" 24" 24"

# drawer & opening sizing chart (continued)

## credenzas for height-adjustable tables

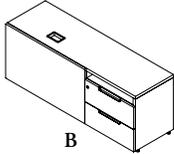
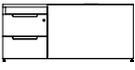
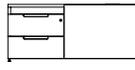
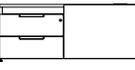
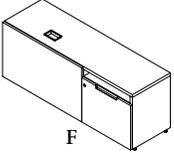
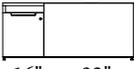
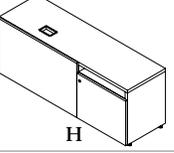
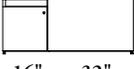
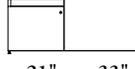
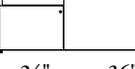
		48"	54"	60"
<b>Double Credenza for Height-Adjustable Table (HTSCC)</b> widths 48", 54" and 60" height 21"	 B	 16" 32"	 21" 33"	 24" 36"
	 F	 16" 32"	 21" 33"	
	 H	 16" 32"	 21" 33"	 24" 36"

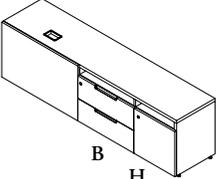
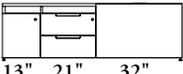
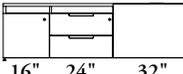
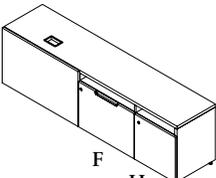
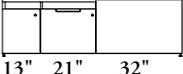
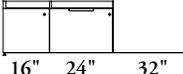
		66"	72"
<b>Triple Credenza for Height-Adjustable Table (HTSCT)</b> widths 66" and 72" height 21"	 B H	 13" 21" 32"	 16" 24" 32"
	 F H	 13" 21" 32"	 16" 24" 32"

## filing capabilities

The following outlines the filing capability of Credenzas.

- 16" deep file drawers do not have full extension files, therefore Filing must be front-to-back not side-to-side
- For 16" and 18" wide file drawers only one front-to-back filing can be used (letter)
- For 21" and 24" wide file drawers only one front-to-back filing can be used (letter, legal, A4 or foolscap)
- For 30" wide file drawers two front-to-back filing sections can be used (letter) or one filing section (legal, A4 or foolscap)
- For 36" wide filing drawers, two front-to-back filing sections can be used (letter, legal, A4 or foolscap)

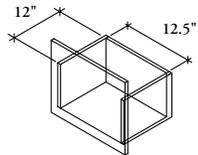

16" wide drawer

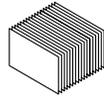

Letter

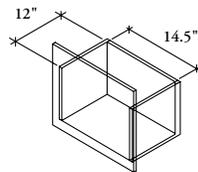

18" wide drawer

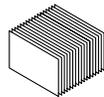

Letter

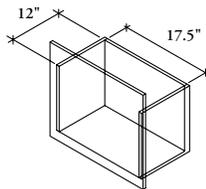

21" wide drawer

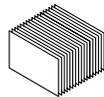

Letter, Legal, A4 and Foolscap

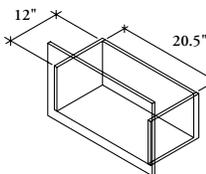

24" wide drawer

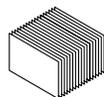

Letter, Legal, A4 and Foolscap

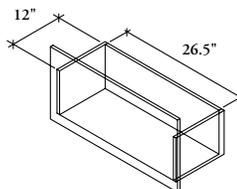

30" wide drawer

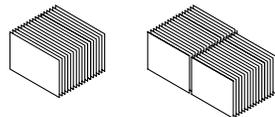

Legal, A4 and Foolscap      Letter

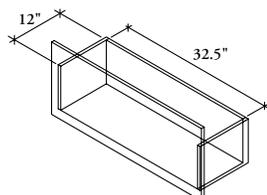

36" wide drawer

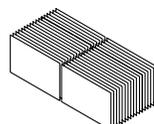

Letter

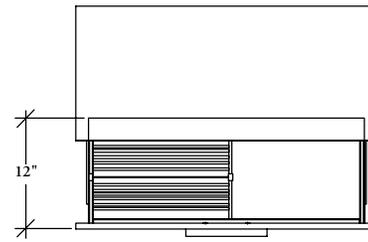

Front-to-Back

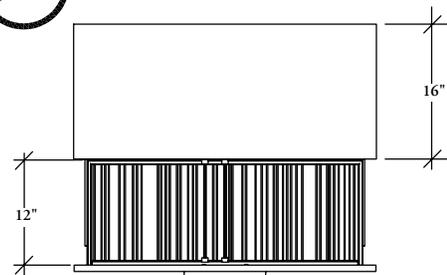

Side-to-Side



price & product guide

# price & product guide

STAGE . . . . .	233
WORKSURFACE SUPPORT . . . . .	259
HEIGHT-ADJUSTABILITY . . . . .	301
CASUAL SCREENS . . . . .	329
FUNCTIONAL SCREENS . . . . .	415
HUTCH SCREEN ACCESS . . . . .	429
STORAGE . . . . .	467
STORAGE ACCESSORIES . . . . .	529
ELECTRICS . . . . .	547

stage



# product map

## H T B B Beginning Stage

Page 236

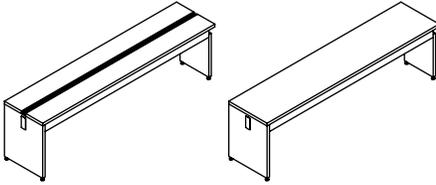

With Accessory Beam

Without Accessory Beam

## H T B M Middle Stage

Page 238

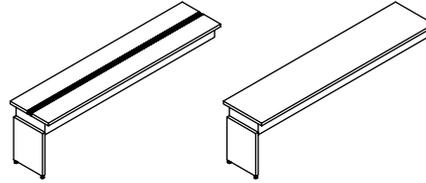

With Accessory Beam

Without Accessory Beam

## H T B F Finish Stage

Page 240

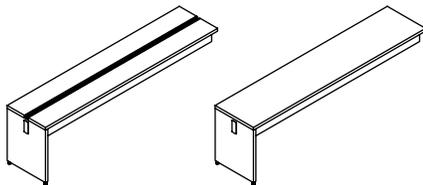

With Accessory Beam

Without Accessory Beam

## H T B C Complete Stage

Page 242

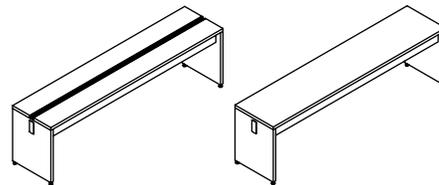

With Accessory Beam

Without Accessory Beam

## H T B S Stage Center Support

Page 245



## H T D B Beginning Simple Stage

Page 246

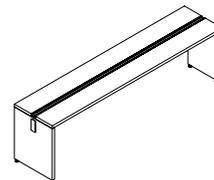

## H T D M Middle Simple Stage

Page 248

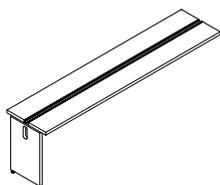

## H T D F Finish Simple Stage

Page 250

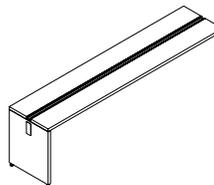

## product map

**H T D C Complete Simple Stage**

Page 252

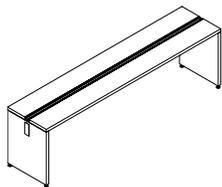

**H T D S Simple Stage Center Support**

Page 254



---

**H T B R Stage Accessory Beam Cover**

Page 255

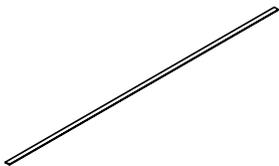

**H T B A Stage Connector**

Page 256



---

**H T B G Stage Grommet**

Page 257





# HTBB Beginning Stage

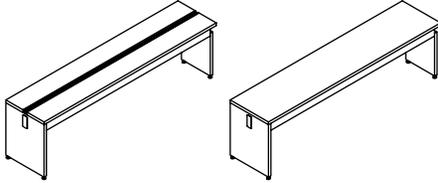

With Accessory Beam

Without Accessory Beam

The Beginning Stage is always used as the first module when a large spanning Stage is desired. It must be attached to either a Middle Stage (HTBM) or a Finish Stage (HTBF).

**WHAT'S INCLUDED**

1 Stage with optional accessory beam, single or double side power and infeed grommet.

**NOTES**

With both Single and Double Sided Power options selected the related electrical components must be specified separately.

If Accessory Beam option is selected, Stage Accessory Beam Cover (HTBR) must be specified separately.

When Infeed Grommets are specified, Grommet Covers are included.

Stages have a 3" nominal leveling range, 1" below and 2" above.

**PRODUCT OPTIONS**

Height	Depth	Width	Accessory Beam	Power/ Data Door	Infeed Grommet	Base Finish	Metal Finish
21	16	48, 54, 60, 66, 72, 78, 84, 90, 96	Y Yes N No	S Single Sided D Double Sided	Y Yes N No	Source Laminate Flintwood Natural Veneer	Foundation Mica Accent

**SAMPLE ORDER CODE**

<b>HTBB 21</b>	<b>16</b>	<b>96</b>	<b>Y</b>	<b>D</b>	<b>Y</b>	<b>XG</b>	<b>74</b>
----------------	-----------	-----------	----------	----------	----------	-----------	-----------

**DIMENSIONS  
INCHES / MM**

H	D	W
21 / 533	16 / 406	48 / 1219
21 / 533	16 / 406	54 / 1372
21 / 533	16 / 406	60 / 1524
21 / 533	16 / 406	66 / 1677
21 / 533	16 / 406	72 / 1829
21 / 533	16 / 406	78 / 1981
21 / 533	16 / 406	84 / 2134
21 / 533	16 / 406	90 / 2286
21 / 533	16 / 406	96 / 2438

21 / 533	16 / 406	48 / 1219
21 / 533	16 / 406	54 / 1372
21 / 533	16 / 406	60 / 1524
21 / 533	16 / 406	66 / 1677
21 / 533	16 / 406	72 / 1829
21 / 533	16 / 406	78 / 1981
21 / 533	16 / 406	84 / 2134
21 / 533	16 / 406	90 / 2286
21 / 533	16 / 406	96 / 2438

**PRICING**

**WITHOUT ACCESSORY BEAM (N)**

**SINGLE SIDED (S)**

**WITHOUT INFEED GROMMET (N)**

Source Laminate	Flintwood	Natural Veneer
1221	2643	2726
1273	2752	2838
1324	2862	2951
1376	2973	3064
1427	3082	3176
1480	3192	3287
1531	3301	3404
1583	3410	3515
1635	3520	3628

**WITH INFEED GROMMET (Y)**

Source Laminate	Flintwood	Natural Veneer
1294	2719	2801
1347	2826	2912
1398	2937	3026
1449	3045	3139
1501	3156	3251
1553	3268	3364
1607	3376	3480
1659	3486	3589
1711	3594	3703

**DOUBLE SIDED (D)**

**WITHOUT INFEED GROMMET (N)**

Source Laminate	Flintwood	Natural Veneer
1355	2777	2859
1416	2896	2982
1478	3018	3105
1542	3139	3227
1604	3256	3353
1667	3377	3478
1731	3497	3599
1792	3618	3723
1856	3739	3847

**WITH INFEED GROMMET (Y)**

Source Laminate	Flintwood	Natural Veneer
1427	2853	2935
1491	2973	3058
1552	3094	3180
1618	3211	3302
1679	3332	3427
1741	3453	3549
1805	3573	3674
1867	3694	3797
1930	3813	3920

Pricing is continued on the following page.

If Accent/Mica is specified without infeed grommet, add 14

If Accent/Mica is specified with infeed grommet, add 24

**H T B B**  
**Beginning Stage (Continued)**

**DIMENSIONS  
INCHES / MM**

H	D	W
21 / 533	16 / 406	48 / 1219
21 / 533	16 / 406	54 / 1372
21 / 533	16 / 406	60 / 1524
21 / 533	16 / 406	66 / 1677
21 / 533	16 / 406	72 / 1829
21 / 533	16 / 406	78 / 1981
21 / 533	16 / 406	84 / 2134
21 / 533	16 / 406	90 / 2286
21 / 533	16 / 406	96 / 2438

21 / 533	16 / 406	48 / 1219
21 / 533	16 / 406	54 / 1372
21 / 533	16 / 406	60 / 1524
21 / 533	16 / 406	66 / 1677
21 / 533	16 / 406	72 / 1829
21 / 533	16 / 406	78 / 1981
21 / 533	16 / 406	84 / 2134
21 / 533	16 / 406	90 / 2286
21 / 533	16 / 406	96 / 2438

**PRICING**

**WITH ACCESSORY BEAM (Y)**  
**SINGLE SIDED (S)**

WITHOUT INFEED GROMMET (N)			WITH INFEED GROMMET (Y)		
Source Laminate	Flintwood	Natural Veneer	Source Laminate	Flintwood	Natural Veneer
1368	2792	2875	1444	2866	2948
1440	2920	3006	1516	2995	3080
1512	3051	3140	1588	3125	3214
1582	3179	3271	1658	3253	3345
1655	3309	3404	1731	3383	3480
1726	3437	3536	1802	3512	3611
1799	3568	3669	1873	3641	3744
1870	3697	3799	1945	3768	3877
1942	3826	3932	2016	3899	4007

**DOUBLE SIDED (D)**

WITHOUT INFEED GROMMET (N)			WITH INFEED GROMMET (Y)		
Source Laminate	Flintwood	Natural Veneer	Source Laminate	Flintwood	Natural Veneer
1501	2928	3010	1577	3000	3084
1583	3066	3150	1659	3141	3225
1667	3206	3294	1741	3281	3367
1750	3345	3436	1824	3419	3511
1832	3486	3579	1907	3559	3653
1914	3623	3723	1989	3699	3797
1996	3764	3865	2071	3837	3940
2077	3905	4007	2152	3977	4082
2160	4043	4151	2235	4120	4225

If Accent/Mica is specified without infeed grommet, add 14

If Accent/Mica is specified with infeed grommet, add 24

## HTBM Middle Stage

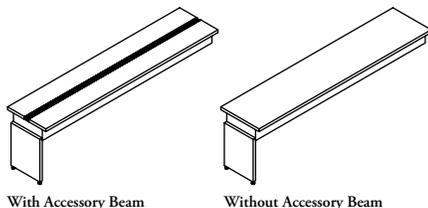

With Accessory Beam

Without Accessory Beam

The Middle Stage is always used between a Beginning Stage (HTBB) and Finish Stage (HTBF) to create large Stage applications.

### WHAT'S INCLUDED

1 Stage with optional accessory beam and single or double side power, 1 mid gable.

### NOTES

With both Single and Double Sided Power options selected the related electrical components must be specified separately.

If Accessory Beam option is selected, Stage Accessory Beam Cover (HTBR) must be specified separately.

Stages have a 3" nominal leveling range, 1" below and 2" above.

### PRODUCT OPTIONS

Height	Depth	Width	Accessory Beam	Power/ Data Door	Base Finish	Metal Finish
21	16	48, 54, 60, 66, 72, 78, 84, 90, 96	<b>Y</b> Yes <b>N</b> No	<b>S</b> Single Sided <b>D</b> Double Sided	Source Laminate Flintwood Natural Veneer	Foundation Mica Accent

### SAMPLE ORDER CODE

<b>HTBM 21</b>	<b>16</b>	<b>96</b>	<b>Y</b>	<b>D</b>	<b>XG</b>	<b>74</b>
----------------	-----------	-----------	----------	----------	-----------	-----------

### DIMENSIONS INCHES / MM

H	D	W
21 / 533	16 / 406	48 / 1219
21 / 533	16 / 406	54 / 1372
21 / 533	16 / 406	60 / 1524
21 / 533	16 / 406	66 / 1677
21 / 533	16 / 406	72 / 1829
21 / 533	16 / 406	78 / 1981
21 / 533	16 / 406	84 / 2134
21 / 533	16 / 406	90 / 2286
21 / 533	16 / 406	96 / 2438

21 / 533	16 / 406	48 / 1219
21 / 533	16 / 406	54 / 1372
21 / 533	16 / 406	60 / 1524
21 / 533	16 / 406	66 / 1677
21 / 533	16 / 406	72 / 1829
21 / 533	16 / 406	78 / 1981
21 / 533	16 / 406	84 / 2134
21 / 533	16 / 406	90 / 2286
21 / 533	16 / 406	96 / 2438

### PRICING

#### WITHOUT ACCESSORY BEAM (N)

##### SINGLE SIDED (S)

Source Laminate	Flintwood	Natural Veneer
1152	2480	2561
1204	2589	2673
1256	2698	2787
1310	2807	2899
1361	2916	3012
1414	3027	3125
1466	3139	3240
1519	3246	3352
1570	3358	3464

##### DOUBLE SIDED (D)

Source Laminate	Flintwood	Natural Veneer
1286	2613	2696
1349	2733	2818
1411	2854	2942
1475	2974	3065
1538	3095	3189
1600	3214	3312
1662	3334	3436
1725	3455	3558
1787	3575	3681

If Accent/Mica is specified without infeed grommet, add 14

If Accent/Mica is specified with infeed grommet, add 24

Pricing is continued on the following page.

**H T B M**  
**Middle Stage (Continued)**

**DIMENSIONS**  
**INCHES / MM**

H	D	W
21 / 533	16 / 406	48 / 1219
21 / 533	16 / 406	54 / 1372
21 / 533	16 / 406	60 / 1524
21 / 533	16 / 406	66 / 1677
21 / 533	16 / 406	72 / 1829
21 / 533	16 / 406	78 / 1981
21 / 533	16 / 406	84 / 2134
21 / 533	16 / 406	90 / 2286
21 / 533	16 / 406	96 / 2438

21 / 533	16 / 406	48 / 1219
21 / 533	16 / 406	54 / 1372
21 / 533	16 / 406	60 / 1524
21 / 533	16 / 406	66 / 1677
21 / 533	16 / 406	72 / 1829
21 / 533	16 / 406	78 / 1981
21 / 533	16 / 406	84 / 2134
21 / 533	16 / 406	90 / 2286
21 / 533	16 / 406	96 / 2438

**PRICING**

**WITH ACCESSORY BEAM (Y)**

**SINGLE SIDED (S)**

Source Laminate	Flintwood	Natural Veneer
1303	2629	2711
1373	2758	2842
1445	2886	2975
1517	3015	3105
1589	3146	3240
1659	3274	3373
1732	3404	3505
1803	3532	3636
1875	3662	3767

**DOUBLE SIDED (D)**

Source Laminate	Flintwood	Natural Veneer
1437	2763	2846
1519	2902	2986
1600	3041	3128
1681	3180	3272
1763	3322	3414
1845	3459	3558
1928	3599	3701
2010	3739	3844
2093	3880	3985

If Accent/Mica is specified without infeed grommet, add 14

If Accent/Mica is specified with infeed grommet, add 24

# HTBF Finish Stage

The Finish Stage is always used as the last module when a large spanning Stage is desired. It must be attached to either a Beginning Stage (HTBB) or a Middle Stage (HTBM).

### WHAT'S INCLUDED

1 stage with optional accessory beam, single or double side power and infeed grommet, 1 end gable.

### NOTES

With both Single and Double Sided Power options selected the related electrical components must be specified separately.

If Accessory Beam option is selected, Stage Accessory Beam Cover (HTBR) must be specified separately.

Stages have a 3" nominal leveling range, 1" below and 2" above.

When Infeed Grommets are specified, Grommet Covers are included.

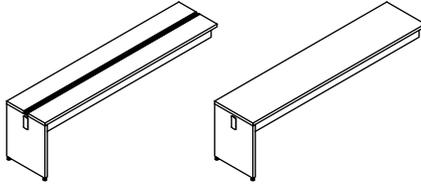

With Accessory Beam

Without Accessory Beam

### PRODUCT OPTIONS

Height	Depth	Width	Accessory Beam	Power/ Data Door	Infeed Grommet	Base Finish	Metal Finish
21	16	48, 54, 60, 66, 72, 78, 84, 90, 96	Y Yes N No	S Single Sided D Double Sided	Y Yes N No	Source Laminate Flintwood Natural Veneer	Foundation Mica Accent

### SAMPLE ORDER CODE

<b>HTBF 21</b>	<b>16</b>	<b>96</b>	<b>Y</b>	<b>D</b>	<b>Y</b>	<b>XG</b>	<b>74</b>
----------------	-----------	-----------	----------	----------	----------	-----------	-----------

### DIMENSIONS INCHES / MM

H	D	W
21 / 533	16 / 406	48 / 1219
21 / 533	16 / 406	54 / 1372
21 / 533	16 / 406	60 / 1524
21 / 533	16 / 406	66 / 1677
21 / 533	16 / 406	72 / 1829
21 / 533	16 / 406	78 / 1981
21 / 533	16 / 406	84 / 2134
21 / 533	16 / 406	90 / 2286
21 / 533	16 / 406	96 / 2438

21 / 533	16 / 406	48 / 1219
21 / 533	16 / 406	54 / 1372
21 / 533	16 / 406	60 / 1524
21 / 533	16 / 406	66 / 1677
21 / 533	16 / 406	72 / 1829
21 / 533	16 / 406	78 / 1981
21 / 533	16 / 406	84 / 2134
21 / 533	16 / 406	90 / 2286
21 / 533	16 / 406	96 / 2438

### PRICING

#### WITHOUT ACCESSORY BEAM (N)

##### SINGLE SIDED (S)

##### WITHOUT INFEED GROMMET (N)

Source Laminate	Flintwood	Natural Veneer
1122	2486	2568
1175	2594	2681
1227	2705	2795
1280	2815	2906
1332	2926	3019
1384	3035	3132
1437	3146	3246
1489	3253	3359
1540	3364	3470

##### WITH INFEED GROMMET (Y)

Source Laminate	Flintwood	Natural Veneer
1256	2620	2702
1318	2741	2825
1381	2860	2948
1445	2981	3071
1507	3101	3195
1570	3222	3320
1632	3341	3443
1696	3460	3566
1757	3582	3692

#### DOUBLE SIDED (D)

##### WITHOUT INFEED GROMMET (N)

Source Laminate	Flintwood	Natural Veneer
1273	2637	2719
1343	2764	2850
1415	2894	2982
1487	3021	3114
1558	3151	3246
1629	3281	3378
1702	3410	3512
1775	3540	3643
1844	3669	3776

##### WITH INFEED GROMMET (Y)

Source Laminate	Flintwood	Natural Veneer
1407	2771	2853
1489	2909	2993
1570	3049	3139
1652	3189	3279
1734	3329	3422
1816	3466	3566
1899	3608	3707
1980	3746	3851
2062	3886	3994

Pricing is continued on the following page.

If Accent/Mica is specified without infeed grommet, add 14

If Accent/Mica is specified with infeed grommet, add 24



**H T B F**  
**Finish Stage (Continued)**

**DIMENSIONS**  
**INCHES / MM**

H	D	W
21 / 533	16 / 406	48 / 1219
21 / 533	16 / 406	54 / 1372
21 / 533	16 / 406	60 / 1524
21 / 533	16 / 406	66 / 1677
21 / 533	16 / 406	72 / 1829
21 / 533	16 / 406	78 / 1981
21 / 533	16 / 406	84 / 2134
21 / 533	16 / 406	90 / 2286
21 / 533	16 / 406	96 / 2438

21 / 533	16 / 406	48 / 1219
21 / 533	16 / 406	54 / 1372
21 / 533	16 / 406	60 / 1524
21 / 533	16 / 406	66 / 1677
21 / 533	16 / 406	72 / 1829
21 / 533	16 / 406	78 / 1981
21 / 533	16 / 406	84 / 2134
21 / 533	16 / 406	90 / 2286
21 / 533	16 / 406	96 / 2438

**PRICING**

**WITH ACCESSORY BEAM (Y)**  
**SINGLE SIDED (S)**

WITHOUT INFEED GROMMET (N)			WITH INFEED GROMMET (Y)		
Source Laminate	Flintwood	Natural Veneer	Source Laminate	Flintwood	Natural Veneer
1197	2561	2643	1332	2696	2777
1250	2671	2756	1394	2815	2900
1303	2780	2868	1457	2936	3023
1355	2889	2981	1520	3057	3147
1407	2999	3095	1581	3176	3271
1459	3110	3207	1645	3295	3394
1510	3219	3322	1707	3415	3517
1564	3329	3434	1771	3536	3640
1615	3438	3546	1833	3655	3764

**DOUBLE SIDED (D)**

WITHOUT INFEED GROMMET (N)			WITH INFEED GROMMET (Y)		
Source Laminate	Flintwood	Natural Veneer	Source Laminate	Flintwood	Natural Veneer
1347	2711	2792	1480	2846	2928
1417	2839	2925	1564	2983	3068
1490	2968	3058	1645	3123	3211
1562	3097	3189	1726	3262	3354
1632	3226	3322	1809	3404	3496
1704	3355	3455	1890	3542	3640
1778	3486	3587	1972	3681	3784
1846	3614	3717	2055	3821	3925
1919	3744	3851	2137	3961	4068

If Accent/Mica is specified without infeed grommet, add 14

If Accent/Mica is specified with infeed grommet, add 24

# HTBC Complete Stage

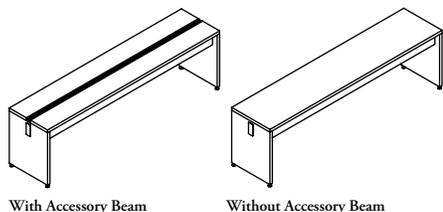

With Accessory Beam

Without Accessory Beam

The Complete Stage is used when a Single 4' - 8' Stage is desired.

### WHAT'S INCLUDED

1 stage with optional accessory beam, single or double side power and infeed grommet, 2 end gables.

### NOTES

With both Single and Double Sided Power options selected the related electrical components must be specified separately.

If Accessory Beam option is selected, Stage Accessory Beam Cover (HTBR) must be specified separately.

Stages have a 3" nominal leveling range, 1" below and 2" above.

When Infeed Grommets are specified, Grommet Covers are included.

### PRODUCT OPTIONS

Height	Depth	Width	Accessory Beam	Power/ Data Door	Infeed Grommet	Base Finish	Metal Finish
21	16	48, 54, 60, 66, 72, 78, 84, 90, 96	Y Yes N No	S Single Sided D Double Sided	S Single Ended D Double Ended N None	Source Laminate Flintwood Natural Veneer	Foundation Mica Accent

### SAMPLE ORDER CODE

<b>HTBC 21</b>	<b>16</b>	<b>96</b>	<b>Y</b>	<b>D</b>	<b>Y</b>	<b>XG</b>	<b>74</b>
----------------	-----------	-----------	----------	----------	----------	-----------	-----------

### DIMENSIONS INCHES / MM

H	D	W
21 / 533	16 / 406	48 / 1219
21 / 533	16 / 406	54 / 1372
21 / 533	16 / 406	60 / 1524
21 / 533	16 / 406	66 / 1677
21 / 533	16 / 406	72 / 1829
21 / 533	16 / 406	78 / 1981
21 / 533	16 / 406	84 / 2134
21 / 533	16 / 406	90 / 2286
21 / 533	16 / 406	96 / 2438

21 / 533	16 / 406	48 / 1219
21 / 533	16 / 406	54 / 1372
21 / 533	16 / 406	60 / 1524
21 / 533	16 / 406	66 / 1677
21 / 533	16 / 406	72 / 1829
21 / 533	16 / 406	78 / 1981
21 / 533	16 / 406	84 / 2134
21 / 533	16 / 406	90 / 2286
21 / 533	16 / 406	96 / 2438

### PRICING

#### WITHOUT ACCESSORY BEAM (N)

##### SINGLE SIDED (S)

##### WITHOUT INFEED GROMMET (N)

Source Laminate	Flintwood	Natural Veneer
1264	2801	2889
1316	2909	3000
1368	3019	3116
1419	3127	3226
1474	3240	3339
1526	3348	3455
1577	3458	3568
1629	3568	3678
1681	3676	3793

##### SINGLE ENDED INFEED GROMMET (S)

Source Laminate	Flintwood	Natural Veneer
1338	2801	2889
1391	2909	3000
1444	3019	3116
1496	3127	3226
1547	3240	3339
1600	3348	3455
1652	3458	3568
1704	3568	3678
1756	3676	3793

##### DOUBLE ENDED INFEED GROMMET (D)

Source Laminate	Flintwood	Natural Veneer
1355	2875	2965
1407	2983	3074
1459	3095	3191
1510	3202	3301
1564	3313	3414
1615	3422	3528
1667	3533	3641
1720	3641	3754
1900	3895	4010

If Accent/Mica is specified with one infeed grommet, add 14

If Accent/Mica is specified with two infeed grommets, add 24

Pricing is continued on the following page.

**H T B C**  
**Complete Stage (Continued)**

**DIMENSIONS**  
**INCHES / MM**

H	D	W
21 / 533	16 / 406	48 / 1219
21 / 533	16 / 406	54 / 1372
21 / 533	16 / 406	60 / 1524
21 / 533	16 / 406	66 / 1677
21 / 533	16 / 406	72 / 1829
21 / 533	16 / 406	78 / 1981
21 / 533	16 / 406	84 / 2134
21 / 533	16 / 406	90 / 2286
21 / 533	16 / 406	96 / 2438

21 / 533	16 / 406	48 / 1219
21 / 533	16 / 406	54 / 1372
21 / 533	16 / 406	60 / 1524
21 / 533	16 / 406	66 / 1677
21 / 533	16 / 406	72 / 1829
21 / 533	16 / 406	78 / 1981
21 / 533	16 / 406	84 / 2134
21 / 533	16 / 406	90 / 2286
21 / 533	16 / 406	96 / 2438

21 / 533	16 / 406	48 / 1219
21 / 533	16 / 406	54 / 1372
21 / 533	16 / 406	60 / 1524
21 / 533	16 / 406	66 / 1677
21 / 533	16 / 406	72 / 1829
21 / 533	16 / 406	78 / 1981
21 / 533	16 / 406	84 / 2134
21 / 533	16 / 406	90 / 2286
21 / 533	16 / 406	96 / 2438

21 / 533	16 / 406	48 / 1219
21 / 533	16 / 406	54 / 1372
21 / 533	16 / 406	60 / 1524
21 / 533	16 / 406	66 / 1677
21 / 533	16 / 406	72 / 1829
21 / 533	16 / 406	78 / 1981
21 / 533	16 / 406	84 / 2134
21 / 533	16 / 406	90 / 2286
21 / 533	16 / 406	96 / 2438

**PRICING**

**WITHOUT ACCESSORY BEAM (N) (Continued)**

DOUBLE SIDED (D)			SINGLE ENDED INFEED GROMMET (S)		
WITHOUT INFEED GROMMET (N)			SINGLE ENDED INFEED GROMMET (S)		
Source Laminate	Flintwood	Natural Veneer	Source Laminate	Flintwood	Natural Veneer
1398	2935	3023	1474	2935	3023
1461	3054	3147	1537	3054	3147
1524	3173	3271	1598	3173	3271
1588	3294	3392	1660	3294	3392
1650	3414	3516	1724	3414	3516
1711	3534	3640	1786	3534	3640
1776	3654	3764	1848	3654	3764
1837	3775	3886	1912	3775	3886
1991	3970	4087	1773	3753	3867

DOUBLE ENDED INFEED GROMMET (D)		
Source Laminate	Flintwood	Natural Veneer
1489	3010	3098
1550	3127	3222
1614	3249	3345
1675	3367	3466
1738	3489	3591
1802	3609	3714
1865	3729	3837
1926	3849	3961
1973	3895	4010

**WITH ACCESSORY BEAM (Y)**

SINGLE SIDED (S)			SINGLE ENDED INFEED GROMMET (S)		
WITHOUT INFEED GROMMET (N)			SINGLE ENDED INFEED GROMMET (S)		
Source Laminate	Flintwood	Natural Veneer	Source Laminate	Flintwood	Natural Veneer
1414	2948	3038	1489	2948	3038
1486	3076	3170	1561	3076	3170
1557	3207	3302	1630	3207	3302
1628	3335	3435	1703	3335	3435
1701	3465	3568	1776	3465	3568
1773	3593	3700	1845	3593	3700
1843	3724	3833	1918	3724	3833
1915	3852	3965	1991	3852	3965
1988	3980	4097	2061	3980	4097

DOUBLE ENDED INFEED GROMMET (D)		
Source Laminate	Flintwood	Natural Veneer
1501	3023	3114
1574	3151	3245
1648	3282	3377
1719	3410	3510
1788	3541	3641
1861	3669	3775
1934	3798	3909
2003	3926	4039
2076	4058	4172

Pricing is continued on the following page.

If Accent/Mica is specified with one infeed grommet, add 14  
If Accent/Mica is specified with two infeed grommets, add 24

**H T B C**

**Complete Stage (Continued)**

**DIMENSIONS  
INCHES / MM**

H	D	W
21 / 533	16 / 406	48 / 1219
21 / 533	16 / 406	54 / 1372
21 / 533	16 / 406	60 / 1524
21 / 533	16 / 406	66 / 1677
21 / 533	16 / 406	72 / 1829
21 / 533	16 / 406	78 / 1981
21 / 533	16 / 406	84 / 2134
21 / 533	16 / 406	90 / 2286
21 / 533	16 / 406	96 / 2438

21 / 533	16 / 406	48 / 1219
21 / 533	16 / 406	54 / 1372
21 / 533	16 / 406	60 / 1524
21 / 533	16 / 406	66 / 1677
21 / 533	16 / 406	72 / 1829
21 / 533	16 / 406	78 / 1981
21 / 533	16 / 406	84 / 2134
21 / 533	16 / 406	90 / 2286
21 / 533	16 / 406	96 / 2438

**PRICING**

**WITH ACCESSORY BEAM (Y) (Continued)**

**DOUBLE SIDED (D)**

**WITHOUT INFEED GROMMET (N)**

Source Laminate	Flintwood	Natural Veneer
1547	3084	3172
1629	3223	3314
1711	3362	3458
1793	3501	3599
1876	3641	3744
1959	3781	3886
2041	3920	4031
2123	4060	4172
2206	4198	4315

**SINGLE ENDED INFEED GROMMET (S)**

Source Laminate	Flintwood	Natural Veneer
1622	3084	3172
1704	3223	3314
1786	3362	3458
1869	3501	3599
1950	3641	3744
2033	3781	3886
2116	3920	4031
2197	4060	4172
2277	4198	4315

**DOUBLE ENDED INFEED GROMMET (D)**

Source Laminate	Flintwood	Natural Veneer
1635	3158	3248
1720	3298	3389
1802	3437	3533
1884	3576	3674
1966	3715	3819
2048	3855	3961
2130	3997	4104
2212	4134	4247
2296	4275	4389

If Accent/Mica is specified with one infeed grommet, add 14

If Accent/Mica is specified with two infeed grommets, add 24

The Stage Center Support provides mid-span support to open bottom of a Stage when not supported by storage.

**HTBS**

**Stage Center Support**

**WHAT'S INCLUDED**

Center support, brackets and attachment hardware.

**NOTES**

Designed to accompany 21" height of the Stage.

Used for additional support on Stages wider than 72" must be mounted in the center location.

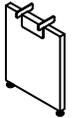

**PRODUCT OPTIONS**

Height	Depth	Base Finish	Bracket Finish
21	16	Source Laminate Flintwood Natural Veneer	Foundation Mica Accent

**SAMPLE ORDER CODE**

<b>HTBS 21</b>	<b>16</b>	<b>XG</b>	<b>74</b>
----------------	-----------	-----------	-----------

**DIMENSIONS  
INCHES / MM**

H	D
21 / 533	16 / 406

**PRICING**

Source Laminate	Flintwood	Natural Veneer
276	603	713

If Accent/Mica is specified with one infeed grommet, add 6

# HTDB Beginning Simple Stage

The Beginning Simple Stage is always used as the first module when a large spanning Stage is desired. It must be attached to either a Middle Simple Stage (HTDM) or a Finish Simple Stage (HTDF).

### WHAT'S INCLUDED

1 Simple Stage with optional accessory beam, single or double side power and infeed grommet.

### NOTES

If Accessory Beam option is selected, Stage Accessory Beam Cover (HTBR) must be specified separately. When Infeed Grommets are specified, Grommet Covers are included. Stages have a 3" nominal leveling range, 1" below and 2" above.

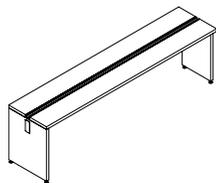

### PRODUCT OPTIONS

Height	Depth	Width (in 6" increments)	Accessory Beam	Power / Data Door	Infeed Grommet	Base Finish	Metal Finish	Bezel Finish
						Source Laminate Flintwood Natural Veneer	Foundation Mica Accent	YD Soft Gris Coordinate YE Anthracite Coordinate
21	16	30 - 96	Y Yes N No	C Center E End	Y Yes N No			

### SAMPLE ORDER CODE

<b>HTDB 21</b>	<b>16</b>	<b>96</b>	<b>Y</b>	<b>E</b>	<b>Y</b>	<b>XG</b>	<b>74</b>	<b>YD</b>
----------------	-----------	-----------	----------	----------	----------	-----------	-----------	-----------

### DIMENSIONS INCHES / MM

H	D	W
21 / 533	16 / 406	30 / 762
21 / 533	16 / 406	36 / 914
21 / 533	16 / 406	42 / 1067
21 / 533	16 / 406	48 / 1219
21 / 533	16 / 406	54 / 1372
21 / 533	16 / 406	60 / 1524
21 / 533	16 / 406	66 / 1677
21 / 533	16 / 406	72 / 1829
21 / 533	16 / 406	78 / 1981
21 / 533	16 / 406	84 / 2134
21 / 533	16 / 406	90 / 2286
21 / 533	16 / 406	96 / 2438

### PRICING

#### WITHOUT ACCESSORY BEAM

#### WITHOUT INFEED GROMMET (N)

Source Laminate	Flintwood	Natural Veneer
1014	2102	2166
1069	2207	2273
1124	2312	2379
1177	2418	2487
1232	2521	2593
1287	2625	2702
1341	2729	2808
1395	2833	2916
1449	2938	3026
1506	3043	3132
1558	3148	3238
1615	3253	3346

#### WITH INFEED GROMMET (Y)

Source Laminate	Flintwood	Natural Veneer
1078	2167	2230
1133	2273	2337
1189	2378	2446
1242	2483	2552
1298	2586	2659
1353	2691	2767
1407	2794	2873
1461	2900	2981
1516	3005	3089
1569	3110	3196
1626	3214	3304
1679	3316	3411

If Accent/Mica is specified without infeed grommet, add 14

If Accent/Mica is specified with infeed grommet, add 24

Pricing is continued on the following page.

**H T D B**  
**Beginning Simple Stage**  
**(Continued)**

**DIMENSIONS**  
**INCHES / MM**

H	D	W
21 / 533	16 / 406	30 / 762
21 / 533	16 / 406	36 / 914
21 / 533	16 / 406	42 / 1067
21 / 533	16 / 406	48 / 1219
21 / 533	16 / 406	54 / 1372
21 / 533	16 / 406	60 / 1524
21 / 533	16 / 406	66 / 1677
21 / 533	16 / 406	72 / 1829
21 / 533	16 / 406	78 / 1981
21 / 533	16 / 406	84 / 2134
21 / 533	16 / 406	90 / 2286
21 / 533	16 / 406	96 / 2438

**PRICING**

WITH ACCESSORY BEAM					
WITHOUT INFEED GROMMET (N)			WITH INFEED GROMMET (Y)		
Source Laminate	Flintwood	Natural Veneer	Source Laminate	Flintwood	Natural Veneer
1094	2182	2244	1160	2246	2310
1163	2303	2368	1230	2367	2434
1235	2426	2493	1302	2488	2559
1309	2547	2619	1373	2611	2682
1379	2668	2742	1444	2733	2805
1449	2789	2865	1516	2854	2930
1521	2910	2989	1589	2975	3054
1594	3034	3114	1658	3096	3179
1663	3151	3238	1731	3219	3304
1735	3275	3362	1802	3339	3428
1809	3396	3487	1871	3459	3550
1879	3517	3611	1944	3584	3675

If Accent/Mica is specified without infeed grommet, add 14

If Accent/Mica is specified with infeed grommet, add 24

## HTDM Middle Simple Stage

The Middle Simple Stage is always used between a Beginning Simple Stage (HTDB) and Finish Simple Stage (HTDF) to create large Stage applications.

### WHAT'S INCLUDED

1 Simple Stage with optional accessory beam and single or double side power, 1 mid gable.

### NOTES

With both Single and Double Sided Power options selected the related electrical components must be specified separately. If Accessory Beam option is selected, Stage Accessory Beam Cover (HTBR) must be specified separately. When Infeed Grommets are specified, Grommet Covers are included. Stages have a 3" nominal leveling range, 1" below and 2" above.

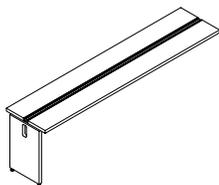

### PRODUCT OPTIONS

Height	Depth	Width (in 6" increments)	Accessory Beam	Power / Data Door	Base Finish	Metal Finish	Bezel Finish
21	16	30 - 96	Y Yes N No	C Center E End	Source Laminate Flintwood Natural Veneer	Foundation Mica Accent	YD Soft Gris Coordinate YE Anthracite Coordinate

### SAMPLE ORDER CODE

<b>HTDM 21</b>	<b>16</b>	<b>96</b>	<b>Y</b>	<b>E</b>	<b>XG</b>	<b>74</b>	<b>YD</b>
----------------	-----------	-----------	----------	----------	-----------	-----------	-----------

### DIMENSIONS INCHES / MM

H	D	W
21 / 533	16 / 406	30 / 762
21 / 533	16 / 406	36 / 914
21 / 533	16 / 406	42 / 1067
21 / 533	16 / 406	48 / 1219
21 / 533	16 / 406	54 / 1372
21 / 533	16 / 406	60 / 1524
21 / 533	16 / 406	66 / 1676
21 / 533	16 / 406	72 / 1729
21 / 533	16 / 406	78 / 1981
21 / 533	16 / 406	84 / 2134
21 / 533	16 / 406	90 / 2286
21 / 533	16 / 406	96 / 2438

### PRICING

#### WITHOUT ACCESSORY BEAM (N)

Source Laminate	Flintwood	Natural Veneer
955	1961	2022
1010	2063	2130
1067	2168	2237
1120	2273	2344
1174	2378	2453
1228	2484	2560
1283	2588	2667
1336	2694	2774
1393	2795	2882
1446	2900	2989
1500	3006	3095
1556	3111	3202

#### WITH ACCESSORY BEAM (Y)

Source Laminate	Flintwood	Natural Veneer
1035	2040	2101
1105	2160	2224
1177	2283	2350
1251	2404	2474
1320	2523	2599
1393	2645	2722
1463	2767	2848
1536	2889	2971
1605	3010	3095
1677	3132	3221
1750	3253	3345
1818	3375	3467

If Accent/Mica is specified without accessory beam, add 14

If Accent/Mica is specified with accessory beam, add 24





# HTDF

## Finish Simple Stage

The Finish Simple Stage is always used as the last module when a large spanning Stage is desired. It must be attached to either a Beginning Simple Stage (HTDB) or a Middle Simple Stage (HTDM).

### WHAT'S INCLUDED

1 Simple Stage with optional accessory beam and single or double side power, 1 end gable.

### NOTES

With both Single and Double Sided Power options selected the related electrical components must be specified separately. If Accessory Beam option is selected, Stage Accessory Beam Cover (HTBR) must be specified separately. When Infeed Grommets are specified, Grommet Covers are included. Stages have a 3" nominal leveling range, 1" below and 2" above.

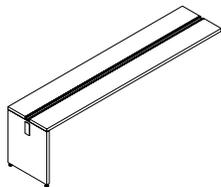

### PRODUCT OPTIONS

Height	Depth	Width (in 6" increments)	Accessory Beam	Power / Data Door	Infeed Grommet	Base Finish		Metal Finish		Bezel Finish		
						Source Laminate	Flintwood	Natural Veneer	Foundation	Mica	Accent	YD Soft Gris Coordinate
21	16	30 - 96	Y Yes N No	C Center E End	Y Yes N No	Source Laminate	Flintwood	Natural Veneer	Foundation	Mica	Accent	YD Soft Gris Coordinate YE Anthracite Coordinate

### SAMPLE ORDER CODE

<b>HTDF 21</b>	<b>16</b>	<b>96</b>	<b>Y</b>	<b>E</b>	<b>Y</b>	<b>XG</b>	<b>74</b>	<b>YD</b>
----------------	-----------	-----------	----------	----------	----------	-----------	-----------	-----------

### DIMENSIONS INCHES / MM

H	D	W
21 / 533	16 / 406	30 / 762
21 / 533	16 / 406	36 / 914
21 / 533	16 / 406	42 / 1067
21 / 533	16 / 406	48 / 1219
21 / 533	16 / 406	54 / 1372
21 / 533	16 / 406	60 / 1524
21 / 533	16 / 406	66 / 1677
21 / 533	16 / 406	72 / 1829
21 / 533	16 / 406	78 / 1981
21 / 533	16 / 406	84 / 2134
21 / 533	16 / 406	90 / 2286
21 / 533	16 / 406	96 / 2438

### PRICING

#### WITHOUT ACCESSORY BEAM

#### WITHOUT INFEED GROMMET (N)

Source Laminate	Flintwood	Natural Veneer
929	1966	2028
984	2071	2134
1039	2177	2244
1094	2280	2350
1148	2382	2457
1202	2488	2564
1257	2592	2672
1311	2698	2780
1365	2803	2887
1419	2907	2996
1475	3011	3102
1529	3117	3209

#### WITH INFEED GROMMET (Y)

Source Laminate	Flintwood	Natural Veneer
995	2031	2094
1048	2134	2202
1104	2240	2308
1158	2344	2418
1213	2449	2523
1267	2553	2630
1323	2659	2736
1376	2763	2846
1433	2866	2954
1486	2973	3060
1540	3074	3166
1596	3180	3275

If Accent/Mica is specified without infeed grommet, add 14

If Accent/Mica is specified with infeed grommet, add 24

Pricing is continued on the following page.

**H T D F**  
**Finish Simple Stage**  
**(Continued)**

**DIMENSIONS**  
**INCHES / MM**

H	D	W
21 / 533	16 / 406	30 / 762
21 / 533	16 / 406	36 / 914
21 / 533	16 / 406	42 / 1067
21 / 533	16 / 406	48 / 1219
21 / 533	16 / 406	54 / 1372
21 / 533	16 / 406	60 / 1524
21 / 533	16 / 406	66 / 1677
21 / 533	16 / 406	72 / 1829
21 / 533	16 / 406	78 / 1981
21 / 533	16 / 406	84 / 2134
21 / 533	16 / 406	90 / 2286
21 / 533	16 / 406	96 / 2438

**PRICING**

WITH ACCESSORY BEAM Y								
WITHOUT INFEED GROMMET (N)						WITH INFEED GROMMET (Y)		
Source Laminate	Flintwood	Natural Veneer		Source Laminate	Flintwood	Natural Veneer		
1010	2046	2107		1074	2109	2175		
1080	2166	2232		1145	2232	2298		
1152	2288	2357		1218	2352	2421		
1223	2409	2483		1287	2474	2547		
1295	2531	2605		1359	2594	2669		
1365	2653	2729		1433	2717	2794		
1438	2774	2853		1500	2839	2918		
1510	2895	2978		1573	2960	3042		
1580	3015	3102		1645	3082	3166		
1652	3140	3226		1715	3202	3293		
1724	3257	3350		1787	3325	3414		
1793	3381	3475		1859	3445	3540		

If Accent/Mica is specified without infeed grommet, add 14

If Accent/Mica is specified with infeed grommet, add 24

# HTDC Complete Simple Stage

The Complete Stage is used when a Single 30" - 96" Stage is desired.

### WHAT'S INCLUDED

1 Simple Stage with optional accessory beam, single or double side power and infeed grommet, 2 end gables.

### NOTES

If Accessory Beam option is selected, Stage Accessory Beam Cover (HTBR) must be specified separately. When Infeed Grommets are specified, Grommet Covers are included. Stages have a 3" nominal leveling range, 1" below and 2" above.

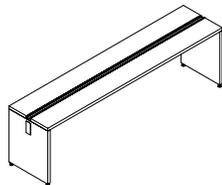

### PRODUCT OPTIONS

Height	Depth	Width (in 6" increments)	Accessory Beam	Power / Data Door	Infeed Grommet	Base Finish		Metal Finish		Bezel Finish			
						Source Laminate	Flintwood	Natural Veneer	Foundation	Mica	Accent	YD Soft Gris Coordinate	YE Anthracite Coordinate
21	16	30 - 96	Y Yes N No	C Center E End	S Single Ended D Double Ended N None	Source Laminate	Flintwood	Natural Veneer	Foundation	Mica	Accent	YD Soft Gris Coordinate	YE Anthracite Coordinate

### SAMPLE ORDER CODE

<b>HTDC 21</b>	<b>16</b>	<b>96</b>	<b>Y</b>	<b>E</b>	<b>S</b>	<b>XG</b>	<b>74</b>	<b>YD</b>
----------------	-----------	-----------	----------	----------	----------	-----------	-----------	-----------

### DIMENSIONS INCHES / MM

H	D	W
21 / 533	16 / 406	30 / 762
21 / 533	16 / 406	36 / 914
21 / 533	16 / 406	42 / 1067
21 / 533	16 / 406	48 / 1219
21 / 533	16 / 406	54 / 1372
21 / 533	16 / 406	60 / 1524
21 / 533	16 / 406	66 / 1677
21 / 533	16 / 406	72 / 1829
21 / 533	16 / 406	78 / 1981
21 / 533	16 / 406	84 / 2134
21 / 533	16 / 406	90 / 2286
21 / 533	16 / 406	96 / 2438

### PRICING

#### WITHOUT ACCESSORY BEAM

##### Without Infeed Grommet (N)

Source Laminate	Flintwood	Natural Veneer
1024	2214	2285
1085	2326	2397
1145	2434	2510
1218	2552	2630
1269	2657	2736
1327	2762	2846
1380	2865	2952
1436	2971	3059
1490	3073	3166
1544	3179	3275
1598	3284	3381
1732	3455	3555

##### Single Ended Infeed Grommet (S)

Source Laminate	Flintwood	Natural Veneer
1181	2283	2351
1223	2379	2453
1266	2474	2551
1282	2552	2630
1336	2657	2736
1389	2762	2846
1445	2865	2952
1499	2971	3059
1553	3073	3166
1607	3179	3275
1663	3284	3381
1542	3267	3364

Pricing is continued on the following page.

If Accent/Mica is specified with one infeed grommet, add 14

If Accent/Mica is specified with two infeed grommets, add 24

**HTDC**  
**Complete Simple Stage**  
**(Continued)**

**DIMENSIONS**  
**INCHES / MM**

H	D	W
21 / 533	16 / 406	30 / 762
21 / 533	16 / 406	36 / 914
21 / 533	16 / 406	42 / 1067
21 / 533	16 / 406	48 / 1219
21 / 533	16 / 406	54 / 1372
21 / 533	16 / 406	60 / 1524
21 / 533	16 / 406	66 / 1677
21 / 533	16 / 406	72 / 1829
21 / 533	16 / 406	78 / 1981
21 / 533	16 / 406	84 / 2134
21 / 533	16 / 406	90 / 2286
21 / 533	16 / 406	96 / 2438

H	D	W
21 / 533	16 / 406	30 / 762
21 / 533	16 / 406	36 / 914
21 / 533	16 / 406	42 / 1067
21 / 533	16 / 406	48 / 1219
21 / 533	16 / 406	54 / 1372
21 / 533	16 / 406	60 / 1524
21 / 533	16 / 406	66 / 1677
21 / 533	16 / 406	72 / 1829
21 / 533	16 / 406	78 / 1981
21 / 533	16 / 406	84 / 2134
21 / 533	16 / 406	90 / 2286
21 / 533	16 / 406	96 / 2438

21 / 533	16 / 406	30 / 762
21 / 533	16 / 406	36 / 914
21 / 533	16 / 406	42 / 1067
21 / 533	16 / 406	48 / 1219
21 / 533	16 / 406	54 / 1372
21 / 533	16 / 406	60 / 1524
21 / 533	16 / 406	66 / 1677
21 / 533	16 / 406	72 / 1829
21 / 533	16 / 406	78 / 1981
21 / 533	16 / 406	84 / 2134
21 / 533	16 / 406	90 / 2286
21 / 533	16 / 406	96 / 2438

**PRICING**

**WITHOUT ACCESSORY BEAM (CONTINUED)**

**Double Ended Infeed Grommet (D)**

Source Laminate	Flintwood	Natural Veneer
1135	2328	2396
1190	2427	2499
1243	2528	2602
1295	2619	2697
1348	2721	2803
1406	2826	2910
1459	2930	3015
1513	3036	3123
1568	3141	3231
1622	3245	3339
1675	3348	3445
1719	3389	3488

**WITH ACCESSORY BEAM**

**Without Infeed Grommet (N)**

Source Laminate	Flintwood	Natural Veneer
1131	2318	2389
1203	2440	2513
1275	2561	2637
1347	2682	2760
1417	2803	2884
1490	2926	3008
1561	3045	3132
1632	3169	3256
1703	3287	3381
1776	3411	3508
1846	3532	3629
1918	3652	3754

**Single Ended Infeed Grommet (S)**

Source Laminate	Flintwood	Natural Veneer
1197	2318	2389
1268	2440	2513
1340	2561	2637
1411	2682	2760
1483	2803	2884
1553	2926	3008
1627	3045	3132
1697	3169	3256
1768	3287	3381
1840	3411	3508
1912	3532	3629
1982	3652	3754

**Double Ended Infeed Grommet (D)**

Source Laminate	Flintwood	Natural Veneer
1210	2382	2453
1281	2504	2576
1354	2625	2699
1422	2747	2825
1496	2868	2948
1568	2990	3073
1637	3112	3196
1710	3232	3323
1781	3354	3445
1854	3478	3571
1925	3596	3696
1996	3720	3819

If Accent/Mica is specified with one infeed grommet, add 14

If Accent/Mica is specified with two infeed grommets, add 24

# HTDS

## Simple Stage Center Support

The Simple Stage Center Support provides mid-span support to open bottom of a Simple Stage when not supported by storage.

**WHAT'S INCLUDED**

Center support, brackets and attachment hardware.

**NOTES**

Designed to accompany 21" height of the Stage.

Used for additional support on Stages wider than 66"



**PRODUCT OPTIONS**

Height	Depth	Base Finish	Bracket Finish
21	16	Source Laminate Flintwood Natural Veneer	Foundation Mica Accent

**SAMPLE ORDER CODE**

<b>HTDS 21</b>	<b>16</b>	<b>XG</b>	<b>74</b>
----------------	-----------	-----------	-----------

**DIMENSIONS  
INCHES / MM**

H	D
21 / 533	16 / 406

**PRICING**

Source Laminate	Flintwood	Natural Veneer
235	511	608

If Accent/Mica is specified with one infeed grommet, add 6

The Stage Accessory Beam Cover provides an aesthetic look and hides the interior of the Accessory Beam on top of the Stage.

**HTBR**

**Stage Accessory Beam Cover**

**WHAT'S INCLUDED**

1 stage accessory beam cover.

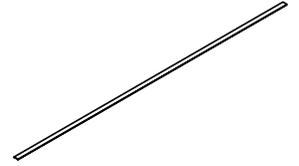

**PRODUCT OPTIONS**

Width	Accessory Beam Cover Finish
48, 54, 60, 66, 72, 78, 84, 90, 96	Foundation Mica Accent

**SAMPLE ORDER CODE**

<b>HTBR 72</b>	<b>74</b>
----------------	-----------

**DIMENSIONS  
INCHES / MM**

W
48 / 1219
54 / 1372
60 / 1524
66 / 1677
72 / 1829
78 / 1981
84 / 2134
90 / 2286
96 / 2438

**PRICING**

	Foundation	Accent/Mica
	113	119
	126	130
	140	148
	153	159
	164	176
	180	187
	191	205
	208	216
	218	233

**H T B A**  
**Stage Connector**

The Stage Connector is a two-way connector that creates a connection between two End Gables finished Stages.

**WHAT'S INCLUDED**

1 stage connector



**PRICING**

---

44

---



The Stage Grommet is mounted on a pass-through ring on a Stage.

**WHAT'S INCLUDED**

1 stage grommet.

**HTBG**  
**Stage Grommet**



**PRODUCT OPTIONS**

**Grommet Finish**

Foundation

Mica

Source Laminate (Wood Print Only)

**SAMPLE ORDER CODE**

**HTBG 74**

**PRICING**

22

worksurfaces &  
supports

# product map

**H T W R Parallel Worksurface**

Page 262

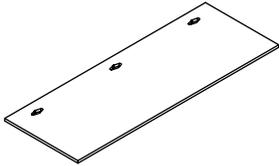

**H T W P Perpendicular Worksurface**

Page 266

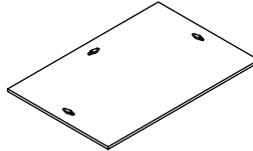

**H T W H Perpendicular with Radius Corner Worksurface**

Page 270

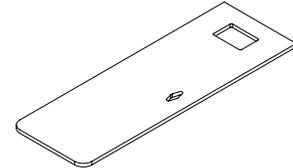

**H T W V Dual Perpendicular Worksurface**

Page 274

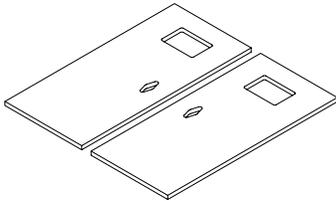

**H T W W Dual Perpendicular with Radius Corner Worksurface**

Page 276

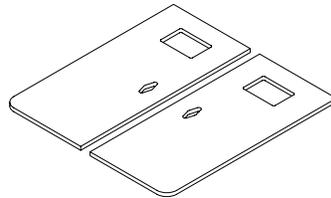

**H T W G End Worksurface**

Page 278

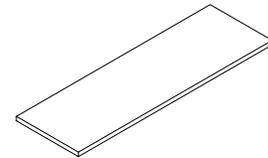

**H T W Z End with Radius Corners Worksurface**

Page 279

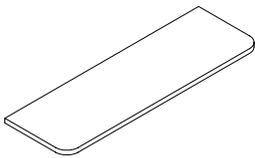

**H T W T Interpret Style Table**

Page 280

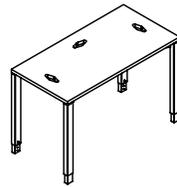

**H T W U Interpret Style Radius Corner Table**

Page 282

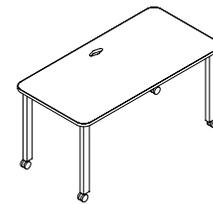

**H T W N Interpret Style Leg**

Page 284

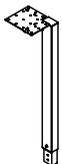

**H T W M Interpret Style Mono Leg**

Page 285

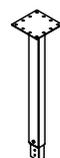

**H T W E Y Table**

Page 286



## product map

**H T W X Y Table Radius Corner**

Page 287



**H T W D Y Leg**

Page 288



**H T W Q Stage to Worksurface Support**

Page 289

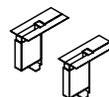

**H T W S Storage Back to Worksurface Support**

Page 290

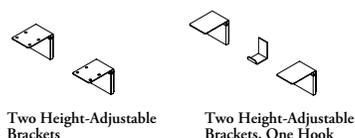

Two Height-Adjustable Brackets

Two Height-Adjustable Brackets, One Hook

**H T W C Credenza to Worksurface Support**

Page 291



**H T W B Stage to Dual Worksurface Support Kit**

Page 292

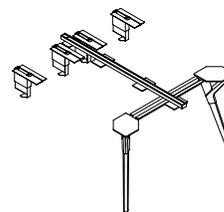

**H T W J End Worksurface Support Kit**

Page 294

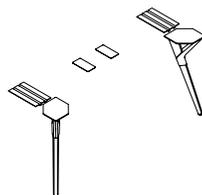

**H T W F Hutch to Worksurface Support**

Page 295

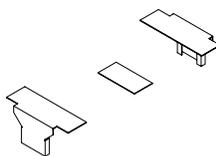

**H T W Y Worksurface Support Wire Manager**

Page 296



**H T W A Flush Plate**

Page 297

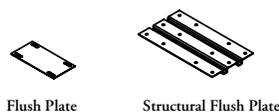

Flush Plate

Structural Flush Plate

**U N R C Worksurface Reinforcement Channel**

Page 298

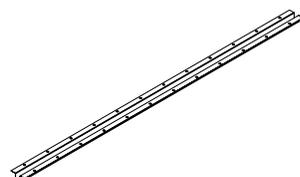



# worksurfaces & supports

## HTWR

### Parallel Worksurface

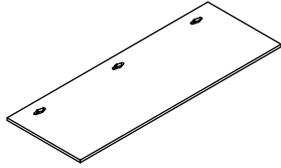

The Parallel Worksurface provides a range of depths to support the primary and single sided worksurface applications.

#### WHAT'S INCLUDED

1 worksurface.

#### NOTES

Dimensions are actual width, allowance for gaps at side edges must be specified.

The number and location of Cut Outs vary, refer to the *Application Guides* for more details.

Access door Cut Out options are not available for 23" depth worksurface.

Worksurfaces include only a cut out in the worksurface. When Rectangular Cut Out (RN, RC, RL) is specified, a Rectangular Grommet (HTEG) must be ordered separately. When Access Door Cut Out (AN, AC, AL) is specified, a kit of products including the Access Door for Multi-Circuit Desk (HTEA), Multi-Circuit Desk Housing (HTEN), Multi-Circuit Desk Power Module (HTEM) and Receptacle Outlet (HTERO) must be specified separately.

#### PRODUCT OPTIONS

Depth	Width (in 1" increments)	Access Door Cut Out		Rectangle Cut Out		Worksurface Finish	Edge Trim Styles		Edge Trim Finishes							
		AN	AC	AL	AR		RN	RC		RL	RR	8	9	H		
23, 29, 35	30, 36, 42 - 96	No Access Door Cut Out	Center Access Door Cut Out	Left Access Door Cut Out	Right Access Door Cut Out	No Rectangle Cut Out	Center Rectangle Cut Out	Left Rectangle Cut Out	Right Rectangle Cut Out	Foundation Laminate	Flintwood	Natural Veneer	Flat (Foundation Laminate)	Flat (Flintwood, Natural Veneer)	Full Knife (Foundation Laminate, Flintwood, Natural Veneer)	Edge Trim Colors

#### SAMPLE ORDER CODE

HTWR 23	48	AN	RL	LW	8	ST
---------	----	----	----	----	---	----

#### DIMENSIONS INCHES / MM

D	W
23 / 584	30 / 762
23 / 584	36 / 762
23 / 584	42 / 1067
23 / 584	43 / 1092
23 / 584	44 / 1118
23 / 584	45 / 1143
23 / 584	46 / 1168
23 / 584	47 / 1194
23 / 584	48 / 1219
23 / 584	49 / 1245
23 / 584	50 / 1270
23 / 584	51 / 1295
23 / 584	52 / 1321
23 / 584	53 / 1346
23 / 584	54 / 1372
23 / 584	55 / 1397
23 / 584	56 / 1422
23 / 584	57 / 1448
23 / 584	58 / 1473
23 / 584	59 / 1499
23 / 584	60 / 1524
23 / 584	61 / 1549
23 / 584	62 / 1575

#### PRICING

FOUNDATION		FLINTWOOD		VENEER	
Flat Trim	Full Knife Trim	Flat Trim	Full Knife Trim	Flat Trim	Full Knife Trim
394	491	887	1024	929	1075
443	556	969	1113	1015	1168
483	618	1083	1249	1136	1309
488	625	1125	1293	1177	1355
488	625	1125	1293	1177	1355
488	625	1125	1293	1177	1355
492	635	1165	1335	1222	1400
492	635	1165	1335	1222	1400
492	635	1165	1335	1222	1400
645	833	1251	1440	1311	1510
645	833	1251	1440	1311	1510
645	833	1251	1440	1311	1510
649	843	1293	1485	1355	1556
649	843	1293	1485	1355	1556
649	843	1293	1485	1355	1556
655	850	1333	1528	1395	1602
655	850	1333	1528	1395	1602
655	850	1333	1528	1395	1602
661	858	1373	1573	1439	1649
661	858	1373	1573	1439	1649
661	858	1373	1573	1439	1649
665	864	1437	1648	1506	1726
665	864	1437	1648	1506	1726

If Cut Out is specified, add 43 for each

Pricing is continued on the following page.

**H T W R**  
**Parallel Worksurface (Continued)**

**DIMENSIONS  
INCHES / MM**

**PRICING**

DIMENSIONS INCHES / MM		FOUNDATION		FLINTWOOD		VENEER	
D	W	Flat Trim	Full Knife Trim	Flat Trim	Full Knife Trim	Flat Trim	Full Knife Trim
23 / 584	63 / 1600	665	864	1437	1648	1506	1726
23 / 584	64 / 1626	671	874	1476	1693	1547	1773
23 / 584	65 / 1651	671	874	1476	1693	1547	1773
23 / 584	66 / 1676	671	874	1476	1693	1547	1773
23 / 584	67 / 1702	675	882	1517	1734	1591	1817
23 / 584	68 / 1727	675	882	1517	1734	1591	1817
23 / 584	69 / 1753	675	882	1517	1734	1591	1817
23 / 584	70 / 1778	680	889	1558	1780	1632	1865
23 / 584	71 / 1803	680	889	1558	1780	1632	1865
23 / 584	72 / 1829	680	889	1558	1780	1632	1865
23 / 584	73 / 1854	745	989	1599	1824	1675	1912
23 / 584	74 / 1880	745	989	1599	1824	1675	1912
23 / 584	75 / 1905	745	989	1599	1824	1675	1912
23 / 584	76 / 1930	751	997	1641	1867	1720	1957
23 / 584	77 / 1956	751	997	1641	1867	1720	1957
23 / 584	78 / 1981	751	997	1641	1867	1720	1957
23 / 584	79 / 2007	756	1005	1680	1912	1761	2003
23 / 584	80 / 2032	756	1005	1680	1912	1761	2003
23 / 584	81 / 2057	756	1005	1680	1912	1761	2003
23 / 584	82 / 2083	762	1014	1765	2016	1850	2115
23 / 584	83 / 2108	762	1014	1765	2016	1850	2115
23 / 584	84 / 2134	762	1014	1765	2016	1850	2115
23 / 584	85 / 2159	766	1021	1807	2061	1892	2160
23 / 584	86 / 2184	766	1021	1807	2061	1892	2160
23 / 584	87 / 2210	766	1021	1807	2061	1892	2160
23 / 584	88 / 2235	770	1030	1846	2104	1937	2207
23 / 584	89 / 2261	770	1030	1846	2104	1937	2207
23 / 584	90 / 2286	770	1030	1846	2104	1937	2207
23 / 584	91 / 2311	776	1038	1889	2149	1978	2253
23 / 584	92 / 2337	776	1038	1889	2149	1978	2253
23 / 584	93 / 2362	776	1038	1889	2149	1978	2253
23 / 584	94 / 2388	782	1045	1930	2193	2022	2299
23 / 584	95 / 2413	782	1045	1930	2193	2022	2299
23 / 584	96 / 2438	782	1045	1930	2193	2022	2299
29 / 737	30 / 762	445	557	1012	1173	1061	1228
29 / 737	36 / 762	457	578	1102	1273	1157	1333
29 / 737	42 / 1067	527	673	1241	1433	1299	1499
29 / 737	43 / 1092	533	681	1285	1480	1347	1552
29 / 737	44 / 1118	533	681	1285	1480	1347	1552
29 / 737	45 / 1143	533	681	1285	1480	1347	1552
29 / 737	46 / 1168	541	691	1332	1529	1394	1604
29 / 737	47 / 1194	541	691	1332	1529	1394	1604
29 / 737	48 / 1219	541	691	1332	1529	1394	1604
29 / 737	49 / 1245	664	859	1398	1610	1466	1688
29 / 737	50 / 1270	664	859	1398	1610	1466	1688
29 / 737	51 / 1295	664	859	1398	1610	1466	1688
29 / 737	52 / 1321	670	868	1444	1659	1513	1740
29 / 737	53 / 1346	670	868	1444	1659	1513	1740
29 / 737	54 / 1372	670	868	1444	1659	1513	1740
29 / 737	55 / 1397	675	876	1490	1710	1561	1792
29 / 737	56 / 1422	675	876	1490	1710	1561	1792
29 / 737	57 / 1448	675	876	1490	1710	1561	1792

If Cut Out is specified, add 43 for each

Pricing is continued on the following page.

# worksurfaces & supports

H T W R

## Parallel Worksurface (Continued)

DIMENSIONS  
INCHES / MM

PRICING

D	W	FOUNDATION		FLINTWOOD		VENEER	
		Flat Trim	Full Knife Trim	Flat Trim	Full Knife Trim	Flat Trim	Full Knife Trim
29 / 737	58 / 1473	681	886	1536	1758	1607	1844
29 / 737	59 / 1499	681	886	1536	1758	1607	1844
29 / 737	60 / 1524	681	886	1536	1758	1607	1844
29 / 737	61 / 1549	687	894	1580	1810	1655	1896
29 / 737	62 / 1575	687	894	1580	1810	1655	1896
29 / 737	63 / 1600	687	894	1580	1810	1655	1896
29 / 737	64 / 1626	694	902	1671	1919	1751	2012
29 / 737	65 / 1651	694	902	1671	1919	1751	2012
29 / 737	66 / 1676	694	902	1671	1919	1751	2012
29 / 737	67 / 1702	700	913	1715	1969	1799	2063
29 / 737	68 / 1727	700	913	1715	1969	1799	2063
29 / 737	69 / 1753	700	913	1715	1969	1799	2063
29 / 737	70 / 1778	705	921	1761	2019	1845	2116
29 / 737	71 / 1803	705	921	1761	2019	1845	2116
29 / 737	72 / 1829	705	921	1761	2019	1845	2116
29 / 737	73 / 1854	1065	1408	1807	2070	1892	2167
29 / 737	74 / 1880	1065	1408	1807	2070	1892	2167
29 / 737	75 / 1905	1065	1408	1807	2070	1892	2167
29 / 737	76 / 1930	1070	1416	1853	2119	1941	2221
29 / 737	77 / 1956	1070	1416	1853	2119	1941	2221
29 / 737	78 / 1981	1070	1416	1853	2119	1941	2221
29 / 737	79 / 2007	1075	1424	1942	2229	2035	2336
29 / 737	80 / 2032	1075	1424	1942	2229	2035	2336
29 / 737	81 / 2057	1075	1424	1942	2229	2035	2336
29 / 737	82 / 2083	1083	1434	1989	2277	2082	2389
29 / 737	83 / 2108	1083	1434	1989	2277	2082	2389
29 / 737	84 / 2134	1083	1434	1989	2277	2082	2389
29 / 737	85 / 2159	1090	1441	2033	2328	2130	2440
29 / 737	86 / 2184	1090	1441	2033	2328	2130	2440
29 / 737	87 / 2210	1090	1441	2033	2328	2130	2440
29 / 737	88 / 2235	1095	1449	2079	2378	2178	2492
29 / 737	89 / 2261	1095	1449	2079	2378	2178	2492
29 / 737	90 / 2286	1095	1449	2079	2378	2178	2492
29 / 737	91 / 2311	1100	1460	2124	2427	2224	2545
29 / 737	92 / 2337	1100	1460	2124	2427	2224	2545
29 / 737	93 / 2362	1100	1460	2124	2427	2224	2545
29 / 737	94 / 2388	1105	1469	2168	2477	2273	2594
29 / 737	95 / 2413	1105	1469	2168	2477	2273	2594
29 / 737	96 / 2438	1105	1469	2168	2477	2273	2594
35 / 889	30 / 762	555	717	1105	1274	1158	1335
35 / 889	36 / 762	647	834	1251	1445	1311	1514
35 / 889	42 / 1067	722	948	1373	1583	1439	1660
35 / 889	43 / 1092	729	955	1422	1642	1491	1720
35 / 889	44 / 1118	729	955	1422	1642	1491	1720
35 / 889	45 / 1143	729	955	1422	1642	1491	1720
35 / 889	46 / 1168	736	966	1474	1696	1544	1778
35 / 889	47 / 1194	736	966	1474	1696	1544	1778
35 / 889	48 / 1219	736	966	1474	1696	1544	1778
35 / 889	49 / 1245	1035	1361	1522	1751	1597	1835
35 / 889	50 / 1270	1035	1361	1522	1751	1597	1835
35 / 889	51 / 1295	1035	1361	1522	1751	1597	1835
35 / 889	52 / 1321	1041	1371	1619	1866	1696	1957

If Cut Out is specified, add 43 for each

Pricing is continued on the following page.



**H T W R**  
**Parallel Worksurface (Continued)**

**DIMENSIONS**  
**INCHES / MM**

**PRICING**

DIMENSIONS		PRICING					
INCHES / MM		FOUNDATION		FLINTWOOD		VENEER	
D	W	Flat Trim	Full Knife Trim	Flat Trim	Full Knife Trim	Flat Trim	Full Knife Trim
35 / 889	53 / 1346	1041	1371	1619	1866	1696	1957
35 / 889	54 / 1372	1041	1371	1619	1866	1696	1957
35 / 889	55 / 1397	1048	1381	1670	1921	1749	2014
35 / 889	56 / 1422	1048	1381	1670	1921	1749	2014
35 / 889	57 / 1448	1048	1381	1670	1921	1749	2014
35 / 889	58 / 1473	1055	1389	1720	1976	1802	2072
35 / 889	59 / 1499	1055	1389	1720	1976	1802	2072
35 / 889	60 / 1524	1055	1389	1720	1976	1802	2072
35 / 889	61 / 1549	1064	1400	1768	2031	1854	2130
35 / 889	62 / 1575	1064	1400	1768	2031	1854	2130
35 / 889	63 / 1600	1064	1400	1768	2031	1854	2130
35 / 889	64 / 1626	1070	1410	1865	2149	1951	2252
35 / 889	65 / 1651	1070	1410	1865	2149	1951	2252
35 / 889	66 / 1676	1070	1410	1865	2149	1951	2252
35 / 889	67 / 1702	1076	1419	1914	2205	2003	2308
35 / 889	68 / 1727	1076	1419	1914	2205	2003	2308
35 / 889	69 / 1753	1076	1419	1914	2205	2003	2308
35 / 889	70 / 1778	1083	1431	1965	2258	2057	2366
35 / 889	71 / 1803	1083	1431	1965	2258	2057	2366
35 / 889	72 / 1829	1083	1431	1965	2258	2057	2366
35 / 889	73 / 1854	1210	1624	2014	2314	2109	2424
35 / 889	74 / 1880	1210	1624	2014	2314	2109	2424
35 / 889	75 / 1905	1210	1624	2014	2314	2109	2424
35 / 889	76 / 1930	1218	1633	2063	2368	2161	2483
35 / 889	77 / 1956	1218	1633	2063	2368	2161	2483
35 / 889	78 / 1981	1218	1633	2063	2368	2161	2483
35 / 889	79 / 2007	1223	1644	2115	2424	2214	2541
35 / 889	80 / 2032	1223	1644	2115	2424	2214	2541
35 / 889	81 / 2057	1223	1644	2115	2424	2214	2541
35 / 889	82 / 2083	1230	1654	2164	2481	2267	2599
35 / 889	83 / 2108	1230	1654	2164	2481	2267	2599
35 / 889	84 / 2134	1230	1654	2164	2481	2267	2599
35 / 889	85 / 2159	1236	1663	2283	2625	2390	2751
35 / 889	86 / 2184	1236	1663	2283	2625	2390	2751
35 / 889	87 / 2210	1236	1663	2283	2625	2390	2751
35 / 889	88 / 2235	1244	1674	2333	2681	2442	2808
35 / 889	89 / 2261	1244	1674	2333	2681	2442	2808
35 / 889	90 / 2286	1244	1674	2333	2681	2442	2808
35 / 889	91 / 2311	1252	1684	2381	2736	2495	2866
35 / 889	92 / 2337	1252	1684	2381	2736	2495	2866
35 / 889	93 / 2362	1252	1684	2381	2736	2495	2866
35 / 889	94 / 2388	1258	1695	2432	2792	2547	2925
35 / 889	95 / 2413	1258	1695	2432	2792	2547	2925
35 / 889	96 / 2438	1258	1695	2432	2792	2547	2925

If Cut Out is specified, add 43 for each

# worksurfaces & supports

## HTWP

### Perpendicular Worksurface

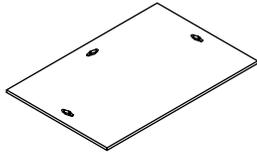

The Perpendicular Worksurface provides a range of depths to support both primary, secondary and single sided worksurface applications.

#### WHAT'S INCLUDED

1 worksurface.

#### NOTES

Dimensions are actual width, allowance for gaps at side edges must be specified.

The number and location of Cut Outs vary, refer to the *Application Guides* for more details.

Worksurfaces include only a cut out in the worksurface. When Rectangular Cut Out (RN, RC, RL) is specified, a Rectangular Grommet (HTEG) must be ordered separately. When Access Door Cut Out (AN, AC, AL) is specified, a kit of products including the Access Door for Multi-Circuit Desk (HTEA), Multi-Circuit Desk Housing (HTEN), Multi-Circuit Desk Power Module (HTEM) and Receptacle Outlet (HTERO) must be specified separately.

#### PRODUCT OPTIONS

Depth	Width (1" increments)	Access Door Cut Out	Rectangle Cut Out	Worksurface Finish	Edge Trim Styles	Edge Trim Finishes
24, 30, 36, 42, 48	46 - 71	<b>AN</b> No Access Door Cut Out	<b>RN</b> No Rectangle Cut Out	Foundation Laminate Flintwood Natural Veneer	<b>8</b> Flat (Foundation Laminate)	Edge Trim Colors
		<b>AL</b> Left Access Door Cut Out	<b>RC</b> Center Rectangle Cut Out			
		<b>AR</b> Right Access Door Cut Out	<b>RL</b> Left Rectangle Cut Out			
			<b>RR</b> Right Rectangle Cut Out			

#### SAMPLE ORDER CODE

<b>HTWP 24</b>	<b>48</b>	<b>AN</b>	<b>RL</b>	<b>LW</b>	<b>8</b>	<b>ST</b>
----------------	-----------	-----------	-----------	-----------	----------	-----------

#### DIMENSIONS INCHES / MM

D	W
24 / 610	46 / 1168
24 / 610	47 / 1194
24 / 610	48 / 1219
24 / 610	49 / 1245
24 / 610	50 / 1270
24 / 610	51 / 1295
24 / 610	52 / 1321
24 / 610	53 / 1346
24 / 610	54 / 1372
24 / 610	55 / 1397
24 / 610	56 / 1422
24 / 610	57 / 1448
24 / 610	58 / 1473
24 / 610	59 / 1499
24 / 610	60 / 1524
24 / 610	61 / 1549
24 / 610	62 / 1575
24 / 610	63 / 1600
24 / 610	64 / 1626
24 / 610	65 / 1651
24 / 610	66 / 1676
24 / 610	67 / 1702
24 / 610	68 / 1727
24 / 610	69 / 1753
24 / 610	70 / 1778
24 / 610	71 / 1803

#### PRICING

FOUNDATION		FLINTWOOD		VENEER	
Flat Trim	Full Knife Trim	Flat Trim	Full Knife Trim	Flat Trim	Full Knife Trim
496	639	1230	1418	1288	1487
496	639	1230	1418	1288	1487
496	639	1230	1418	1288	1487
647	837	1273	1464	1333	1536
647	837	1273	1464	1333	1536
647	837	1273	1464	1333	1536
654	846	1313	1509	1376	1581
654	846	1313	1509	1376	1581
654	846	1313	1509	1376	1581
657	854	1355	1552	1418	1628
657	854	1355	1552	1418	1628
657	854	1355	1552	1418	1628
664	861	1418	1629	1487	1707
664	861	1418	1629	1487	1707
664	861	1418	1629	1487	1707
670	871	1461	1674	1529	1755
670	871	1461	1674	1529	1755
670	871	1461	1674	1529	1755
673	879	1500	1720	1573	1803
673	879	1500	1720	1573	1803
673	879	1500	1720	1573	1803
678	887	1543	1763	1618	1848
678	887	1543	1763	1618	1848
678	887	1543	1763	1618	1848
685	894	1583	1810	1659	1896
685	894	1583	1810	1659	1896

If Cut Out is specified, add 43 for each

Pricing is continued on the following page.

**H T W P**  
**Perpendicular Worksurface**  
**(Continued)**

**DIMENSIONS**  
**INCHES / MM**

**PRICING**

DIMENSIONS		FOUNDATION		FLINTWOOD		VENEER	
D	W	Flat Trim	Full Knife Trim	Flat Trim	Full Knife Trim	Flat Trim	Full Knife Trim
30 / 762	46 / 1168	543	696	1373	1582	1439	1659
30 / 762	47 / 1194	543	696	1373	1582	1439	1659
30 / 762	48 / 1219	543	696	1373	1582	1439	1659
30 / 762	49 / 1245	666	863	1418	1633	1487	1712
30 / 762	50 / 1270	666	863	1418	1633	1487	1712
30 / 762	51 / 1295	666	863	1418	1633	1487	1712
30 / 762	52 / 1321	672	872	1466	1684	1537	1764
30 / 762	53 / 1346	672	872	1466	1684	1537	1764
30 / 762	54 / 1372	672	872	1466	1684	1537	1764
30 / 762	55 / 1397	678	882	1512	1734	1582	1817
30 / 762	56 / 1422	678	882	1512	1734	1582	1817
30 / 762	57 / 1448	678	882	1512	1734	1582	1817
30 / 762	58 / 1473	685	889	1557	1786	1632	1871
30 / 762	59 / 1499	685	889	1557	1786	1632	1871
30 / 762	60 / 1524	685	889	1557	1786	1632	1871
30 / 762	61 / 1549	691	899	1650	1897	1727	1989
30 / 762	62 / 1575	691	899	1650	1897	1727	1989
30 / 762	63 / 1600	691	899	1650	1897	1727	1989
30 / 762	64 / 1626	699	910	1696	1948	1778	2042
30 / 762	65 / 1651	699	910	1696	1948	1778	2042
30 / 762	66 / 1676	699	910	1696	1948	1778	2042
30 / 762	67 / 1702	703	917	1741	1998	1824	2094
30 / 762	68 / 1727	703	917	1741	1998	1824	2094
30 / 762	69 / 1753	703	917	1741	1998	1824	2094
30 / 762	70 / 1778	709	925	1787	2049	1873	2148
30 / 762	71 / 1803	709	925	1787	2049	1873	2148
36 / 914	46 / 1168	738	971	1494	1719	1566	1802
36 / 914	47 / 1194	738	971	1494	1719	1566	1802
36 / 914	48 / 1219	738	971	1494	1719	1566	1802
36 / 914	49 / 1245	1039	1365	1544	1775	1619	1859
36 / 914	50 / 1270	1039	1365	1544	1775	1619	1859
36 / 914	51 / 1295	1039	1365	1544	1775	1619	1859
36 / 914	52 / 1321	1045	1376	1641	1890	1720	1981
36 / 914	53 / 1346	1045	1376	1641	1890	1720	1981
36 / 914	54 / 1372	1045	1376	1641	1890	1720	1981
36 / 914	55 / 1397	1053	1386	1693	1946	1773	2041
36 / 914	56 / 1422	1053	1386	1693	1946	1773	2041
36 / 914	57 / 1448	1053	1386	1693	1946	1773	2041
36 / 914	58 / 1473	1060	1395	1741	2002	1824	2100
36 / 914	59 / 1499	1060	1395	1741	2002	1824	2100
36 / 914	60 / 1524	1060	1395	1741	2002	1824	2100
36 / 914	61 / 1549	1067	1407	1792	2059	1877	2159
36 / 914	62 / 1575	1067	1407	1792	2059	1877	2159
36 / 914	63 / 1600	1067	1407	1792	2059	1877	2159
36 / 914	64 / 1626	1072	1415	1889	2177	1978	2280
36 / 914	65 / 1651	1072	1415	1889	2177	1978	2280
36 / 914	66 / 1676	1072	1415	1889	2177	1978	2280
36 / 914	67 / 1702	1080	1424	1939	2232	2031	2338
36 / 914	68 / 1727	1080	1424	1939	2232	2031	2338
36 / 914	69 / 1753	1080	1424	1939	2232	2031	2338
36 / 914	70 / 1778	1087	1436	1991	2288	2086	2397
36 / 914	71 / 1803	1087	1436	1991	2288	2086	2397

If Cut Out is specified, add 43 for each

Pricing is continued on the following page.

# worksurfaces & supports

## H T W P

### Perpendicular Worksurface (Continued)

#### DIMENSIONS INCHES / MM

#### PRICING

D	W	FOUNDATION		FLINTWOOD		VENEER	
		Flat Trim	Full Knife Trim	Flat Trim	Full Knife Trim	Flat Trim	Full Knife Trim
42 / 1067	46 / 1168	756	995	1658	1914	1737	2003
42 / 1067	47 / 1194	756	995	1658	1914	1737	2003
42 / 1067	48 / 1219	756	995	1658	1914	1737	2003
42 / 1067	49 / 1245	1057	1389	1714	1975	1794	2070
42 / 1067	50 / 1270	1057	1389	1714	1975	1794	2070
42 / 1067	51 / 1295	1057	1389	1714	1975	1794	2070
42 / 1067	52 / 1321	1065	1402	1768	2036	1855	2133
42 / 1067	53 / 1346	1065	1402	1768	2036	1855	2133
42 / 1067	54 / 1372	1065	1402	1768	2036	1855	2133
42 / 1067	55 / 1397	1072	1411	1870	2159	1961	2261
42 / 1067	56 / 1422	1072	1411	1870	2159	1961	2261
42 / 1067	57 / 1448	1072	1411	1870	2159	1961	2261
42 / 1067	58 / 1473	1082	1422	1926	2221	2018	2328
42 / 1067	59 / 1499	1082	1422	1926	2221	2018	2328
42 / 1067	60 / 1524	1082	1422	1926	2221	2018	2328
42 / 1067	61 / 1549	1090	1436	1981	2283	2074	2391
42 / 1067	62 / 1575	1090	1436	1981	2283	2074	2391
42 / 1067	63 / 1600	1090	1436	1981	2283	2074	2391
42 / 1067	64 / 1626	1098	1445	2039	2344	2133	2456
42 / 1067	65 / 1651	1098	1445	2039	2344	2133	2456
42 / 1067	66 / 1676	1098	1445	2039	2344	2133	2456
42 / 1067	67 / 1702	1104	1457	2093	2407	2192	2521
42 / 1067	68 / 1727	1104	1457	2093	2407	2192	2521
42 / 1067	69 / 1753	1104	1457	2093	2407	2192	2521
42 / 1067	70 / 1778	1107	1460	2112	2427	2210	2543
42 / 1067	71 / 1803	1107	1460	2112	2427	2210	2543
48 / 1219	46 / 1168	775	1019	1824	2107	1911	2209
48 / 1219	47 / 1194	775	1019	1824	2107	1911	2209
48 / 1219	48 / 1219	775	1019	1824	2107	1911	2209
48 / 1219	49 / 1245	1075	1415	1885	2177	1973	2280
48 / 1219	50 / 1270	1075	1415	1885	2177	1973	2280
48 / 1219	51 / 1295	1075	1415	1885	2177	1973	2280
48 / 1219	52 / 1321	1084	1427	1945	2243	2039	2350
48 / 1219	53 / 1346	1084	1427	1945	2243	2039	2350
48 / 1219	54 / 1372	1084	1427	1945	2243	2039	2350
48 / 1219	55 / 1397	1094	1439	2003	2310	2100	2421
48 / 1219	56 / 1422	1094	1439	2003	2310	2100	2421
48 / 1219	57 / 1448	1094	1439	2003	2310	2100	2421
48 / 1219	58 / 1473	1101	1449	2064	2378	2163	2490
48 / 1219	59 / 1499	1101	1449	2064	2378	2163	2490
48 / 1219	60 / 1524	1101	1449	2064	2378	2163	2490
48 / 1219	61 / 1549	1112	1464	2193	2537	2298	2655
48 / 1219	62 / 1575	1112	1464	2193	2537	2298	2655
48 / 1219	63 / 1600	1112	1464	2193	2537	2298	2655
48 / 1219	64 / 1626	1121	1475	2254	2604	2360	2727
48 / 1219	65 / 1651	1121	1475	2254	2604	2360	2727
48 / 1219	66 / 1676	1121	1475	2254	2604	2360	2727
48 / 1219	67 / 1702	1129	1487	2313	2671	2423	2797
48 / 1219	68 / 1727	1129	1487	2313	2671	2423	2797
48 / 1219	69 / 1753	1129	1487	2313	2671	2423	2797
48 / 1219	70 / 1778	1131	1491	2334	2694	2443	2822
48 / 1219	71 / 1803	1131	1491	2334	2694	2443	2822

If Cut Out is specified, add 43 for each



# worksurfaces & supports

**H T W H**

## Perpendicular with Radius Corner Worksurface

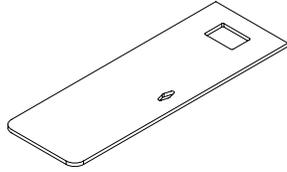

The Perpendicular with Radius Corners Worksurface provides a range of depths to support primary work surface applications.

**WHAT'S INCLUDED**

1 worksurface, grommet (if specified).

**NOTES**

Worksurface is designed to accompany the upStage Infinity Curved Desk Edge Screen (GXCU). Dimensions are actual width, allowance for gaps at side edges must be specified.

**PRODUCT OPTIONS**

Depth	Width (in 1" increments)	Corner Profile	Access Door Cut Out	Rectangle Cut Out	Leg Style	Worksurface Finish	Edge Trim Styles	Edge Trim Finishes
24, 30, 36, 42, 48	46 - 71	<b>F</b> Four Round 3" Radius <b>L</b> Two Round 3" Radius Left <b>R</b> Two Round 3" Radius Right	<b>AN</b> No Access Door Cut Out <b>AL</b> Left Access Door Cut Out <b>AR</b> Right Access Door Cut Out	<b>RN</b> No Rectangle Cut Out <b>RC</b> Center Rectangle Cut Out <b>RL</b> Left Rectangle Cut Out <b>RR</b> Right Rectangle Cut Out	<b>D</b> Y Leg <b>N</b> Interpret Style	Foundation Laminate Flintwood Natural Veneer	<b>8</b> Flat (Foundation Laminate) <b>9</b> Flat (Flintwood, Natural Veneer) <b>H</b> Full Knife (Foundation Laminate, Flintwood, Natural Veneer)	Edge Trim Colors

**SAMPLE ORDER CODE**

<b>HTWH 24</b>	<b>48</b>	<b>R</b>	<b>AN</b>	<b>RL</b>	<b>D</b>	<b>LW</b>	<b>8</b>	<b>ST</b>
----------------	-----------	----------	-----------	-----------	----------	-----------	----------	-----------

**DIMENSIONS  
INCHES / MM**

D	W
24 / 610	46 / 1168
24 / 610	47 / 1194
24 / 610	48 / 1219
24 / 610	49 / 1245
24 / 610	50 / 1270
24 / 610	51 / 1295
24 / 610	52 / 1321
24 / 610	53 / 1346
24 / 610	54 / 1372
24 / 610	55 / 1397
24 / 610	56 / 1422
24 / 610	57 / 1448
24 / 610	58 / 1473
24 / 610	59 / 1499
24 / 610	60 / 1524
24 / 610	61 / 1549
24 / 610	62 / 1575
24 / 610	63 / 1600
24 / 610	64 / 1626
24 / 610	65 / 1651
24 / 610	66 / 1676
24 / 610	67 / 1702
24 / 610	68 / 1727
24 / 610	69 / 1753
24 / 610	70 / 1778
24 / 610	71 / 1803

**PRICING**

FOUNDATION		FLINTWOOD		VENEER	
Flat Trim	Full Knife Trim	Flat Trim	Full Knife Trim	Flat Trim	Full Knife Trim
496	639	1230	1418	1288	1487
496	639	1230	1418	1288	1487
496	639	1230	1418	1288	1487
647	837	1273	1464	1333	1536
647	837	1273	1464	1333	1536
647	837	1273	1464	1333	1536
654	846	1313	1509	1376	1581
654	846	1313	1509	1376	1581
654	846	1313	1509	1376	1581
657	854	1355	1552	1418	1628
657	854	1355	1552	1418	1628
657	854	1355	1552	1418	1628
664	861	1418	1629	1487	1707
664	861	1418	1629	1487	1707
664	861	1418	1629	1487	1707
664	861	1418	1629	1487	1707
670	871	1461	1674	1529	1755
670	871	1461	1674	1529	1755
670	871	1461	1674	1529	1755
673	879	1500	1720	1573	1803
673	879	1500	1720	1573	1803
673	879	1500	1720	1573	1803
673	879	1500	1720	1573	1803
678	887	1543	1763	1618	1848
678	887	1543	1763	1618	1848
678	887	1543	1763	1618	1848
685	894	1583	1810	1659	1896
685	894	1583	1810	1659	1896
685	894	1583	1810	1659	1896

If Cut Out is specified, add 43 for each

Pricing is continued on the following page.

**H T W H**  
**Perpendicular with Radius Corner**  
**Worksurface (Continued)**

**DIMENSIONS**  
**INCHES / MM**

**PRICING**

DIMENSIONS		PRICING					
INCHES / MM		FOUNDATION		FLINTWOOD		VENEER	
D	W	Flat Trim	Full Knife Trim	Flat Trim	Full Knife Trim	Flat Trim	Full Knife Trim
30 / 762	46 / 1168	543	696	1373	1582	1439	1659
30 / 762	47 / 1194	543	696	1373	1582	1439	1659
30 / 762	48 / 1219	543	696	1373	1582	1439	1659
30 / 762	49 / 1245	666	863	1418	1633	1487	1712
30 / 762	50 / 1270	666	863	1418	1633	1487	1712
30 / 762	51 / 1295	666	863	1418	1633	1487	1712
30 / 762	52 / 1321	672	872	1466	1684	1537	1764
30 / 762	53 / 1346	672	872	1466	1684	1537	1764
30 / 762	54 / 1372	672	872	1466	1684	1537	1764
30 / 762	55 / 1397	678	882	1512	1734	1582	1817
30 / 762	56 / 1422	678	882	1512	1734	1582	1817
30 / 762	57 / 1448	678	882	1512	1734	1582	1817
30 / 762	58 / 1473	685	889	1557	1786	1632	1871
30 / 762	59 / 1499	685	889	1557	1786	1632	1871
30 / 762	60 / 1524	685	889	1557	1786	1632	1871
30 / 762	61 / 1549	691	899	1650	1897	1727	1989
30 / 762	62 / 1575	691	899	1650	1897	1727	1989
30 / 762	63 / 1600	691	899	1650	1897	1727	1989
30 / 762	64 / 1626	699	910	1696	1948	1778	2042
30 / 762	65 / 1651	699	910	1696	1948	1778	2042
30 / 762	66 / 1676	699	910	1696	1948	1778	2042
30 / 762	67 / 1702	703	917	1741	1998	1824	2094
30 / 762	68 / 1727	703	917	1741	1998	1824	2094
30 / 762	69 / 1753	703	917	1741	1998	1824	2094
30 / 762	70 / 1778	709	925	1787	2049	1873	2148
30 / 762	71 / 1803	709	925	1787	2049	1873	2148
36 / 914	46 / 1168	738	971	1494	1719	1566	1802
36 / 914	47 / 1194	738	971	1494	1719	1566	1802
36 / 914	48 / 1219	738	971	1494	1719	1566	1802
36 / 914	49 / 1245	1039	1365	1544	1775	1619	1859
36 / 914	50 / 1270	1039	1365	1544	1775	1619	1859
36 / 914	51 / 1295	1039	1365	1544	1775	1619	1859
36 / 914	52 / 1321	1045	1376	1641	1890	1720	1981
36 / 914	53 / 1346	1045	1376	1641	1890	1720	1981
36 / 914	54 / 1372	1045	1376	1641	1890	1720	1981
36 / 914	55 / 1397	1053	1386	1693	1946	1773	2041
36 / 914	56 / 1422	1053	1386	1693	1946	1773	2041
36 / 914	57 / 1448	1053	1386	1693	1946	1773	2041
36 / 914	58 / 1473	1060	1395	1741	2002	1824	2100
36 / 914	59 / 1499	1060	1395	1741	2002	1824	2100
36 / 914	60 / 1524	1060	1395	1741	2002	1824	2100
36 / 914	61 / 1549	1067	1407	1792	2059	1877	2159
36 / 914	62 / 1575	1067	1407	1792	2059	1877	2159
36 / 914	63 / 1600	1067	1407	1792	2059	1877	2159
36 / 914	64 / 1626	1072	1415	1889	2177	1978	2280
36 / 914	65 / 1651	1072	1415	1889	2177	1978	2280
36 / 914	66 / 1676	1072	1415	1889	2177	1978	2280
36 / 914	67 / 1702	1080	1424	1939	2232	2031	2338
36 / 914	68 / 1727	1080	1424	1939	2232	2031	2338
36 / 914	69 / 1753	1080	1424	1939	2232	2031	2338
36 / 914	70 / 1778	1087	1436	1991	2288	2086	2397
36 / 914	71 / 1803	1087	1436	1991	2288	2086	2397

If Cut Out is specified, add 43 for each

Pricing is continued on the following page.

# worksurfaces & supports

## H T W H

### Perpendicular with Radius Corner Worksurface (Continued)

#### DIMENSIONS INCHES / MM

#### PRICING

D	W	FOUNDATION		FLINTWOOD		VENEER	
		Flat Trim	Full Knife Trim	Flat Trim	Full Knife Trim	Flat Trim	Full Knife Trim
42 / 1067	46 / 1168	756	995	1658	1914	1737	2003
42 / 1067	47 / 1194	756	995	1658	1914	1737	2003
42 / 1067	48 / 1219	756	995	1658	1914	1737	2003
42 / 1067	49 / 1245	1057	1389	1714	1975	1794	2070
42 / 1067	50 / 1270	1057	1389	1714	1975	1794	2070
42 / 1067	51 / 1295	1057	1389	1714	1975	1794	2070
42 / 1067	52 / 1321	1065	1402	1768	2036	1855	2133
42 / 1067	53 / 1346	1065	1402	1768	2036	1855	2133
42 / 1067	54 / 1372	1065	1402	1768	2036	1855	2133
42 / 1067	55 / 1397	1072	1411	1870	2159	1961	2261
42 / 1067	56 / 1422	1072	1411	1870	2159	1961	2261
42 / 1067	57 / 1448	1072	1411	1870	2159	1961	2261
42 / 1067	58 / 1473	1082	1422	1926	2221	2018	2328
42 / 1067	59 / 1499	1082	1422	1926	2221	2018	2328
42 / 1067	60 / 1524	1082	1422	1926	2221	2018	2328
42 / 1067	61 / 1549	1090	1436	1981	2283	2074	2391
42 / 1067	62 / 1575	1090	1436	1981	2283	2074	2391
42 / 1067	63 / 1600	1090	1436	1981	2283	2074	2391
42 / 1067	64 / 1626	1098	1445	2039	2344	2133	2456
42 / 1067	65 / 1651	1098	1445	2039	2344	2133	2456
42 / 1067	66 / 1676	1098	1445	2039	2344	2133	2456
42 / 1067	67 / 1702	1104	1457	2093	2407	2192	2521
42 / 1067	68 / 1727	1104	1457	2093	2407	2192	2521
42 / 1067	69 / 1753	1104	1457	2093	2407	2192	2521
42 / 1067	70 / 1778	1107	1460	2112	2427	2210	2543
42 / 1067	71 / 1803	1107	1460	2112	2427	2210	2543
48 / 1219	46 / 1168	775	1019	1824	2107	1911	2209
48 / 1219	47 / 1194	775	1019	1824	2107	1911	2209
48 / 1219	48 / 1219	775	1019	1824	2107	1911	2209
48 / 1219	49 / 1245	1075	1415	1885	2177	1973	2280
48 / 1219	50 / 1270	1075	1415	1885	2177	1973	2280
48 / 1219	51 / 1295	1075	1415	1885	2177	1973	2280
48 / 1219	52 / 1321	1084	1427	1945	2243	2039	2350
48 / 1219	53 / 1346	1084	1427	1945	2243	2039	2350
48 / 1219	54 / 1372	1084	1427	1945	2243	2039	2350
48 / 1219	55 / 1397	1094	1439	2003	2310	2100	2421
48 / 1219	56 / 1422	1094	1439	2003	2310	2100	2421
48 / 1219	57 / 1448	1094	1439	2003	2310	2100	2421
48 / 1219	58 / 1473	1101	1449	2064	2378	2163	2490
48 / 1219	59 / 1499	1101	1449	2064	2378	2163	2490
48 / 1219	60 / 1524	1101	1449	2064	2378	2163	2490
48 / 1219	61 / 1549	1112	1464	2193	2537	2298	2655
48 / 1219	62 / 1575	1112	1464	2193	2537	2298	2655
48 / 1219	63 / 1600	1112	1464	2193	2537	2298	2655
48 / 1219	64 / 1626	1121	1475	2254	2604	2360	2727
48 / 1219	65 / 1651	1121	1475	2254	2604	2360	2727
48 / 1219	66 / 1676	1121	1475	2254	2604	2360	2727
48 / 1219	67 / 1702	1129	1487	2313	2671	2423	2797
48 / 1219	68 / 1727	1129	1487	2313	2671	2423	2797
48 / 1219	69 / 1753	1129	1487	2313	2671	2423	2797
48 / 1219	70 / 1778	1131	1491	2334	2694	2443	2822
48 / 1219	71 / 1803	1131	1491	2334	2694	2443	2822

If Cut Out is specified, add 43 for each





# worksurfaces & supports

## HTWV

### Dual Perpendicular Worksurface

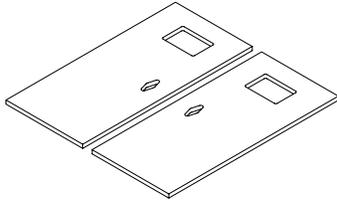

The Dual Perpendicular Worksurface provides two face to face worksurfaces in a range of depths to support both primary, secondary and single sided worksurface applications.

#### WHAT'S INCLUDED

2 worksurfaces.

#### NOTES

Dimensions are actual width, allowance for gaps at side edges must be specified.

The number and location of Cut Outs vary, refer to the Application Guides for more details. Worksurfaces include only a cut out in the worksurface. When Rectangular Cut Out (RN, RC, RL) is specified, a Rectangular Grommet (HTEG) must be ordered separately. When Access Door Cut Out (AN, AC, AL) is specified, a kit of products including the Access Door for Multi-Circuit Desk (HTEA), Multi-Circuit Desk Housing (HTEN), Multi-Circuit Desk Power Module (HTEM), Receptacle Outlet (HTERO) and a Stage to Dual Worksurface Support Kit (HTWB) must be specified separately.

#### PRODUCT OPTIONS

Depth	Width (in 1" increments)	Access Door Cut Out	Rectangle Cut Out	Worksurface Profile	Worksurface Finish	Edge Trim Styles	Edge Trim Finishes
48, 60, 72	46 - 72	<b>AN</b> No Access Door Cut Out <b>AS</b> Stage Access Door Cut Out	<b>RN</b> No Rectangle Cut Out <b>RS</b> Stage Rectangle Cut Out <b>RC</b> Center Rectangle Cut Out	<b>F</b> Flush <b>W</b> Wire Gap	Foundation Laminate Flintwood Natural Veneer	<b>8</b> Flat (Foundation Laminate) <b>9</b> Flat (Flintwood, Natural Veneer) <b>H</b> Full Knife (Foundation Laminate, Flintwood, Natural Veneer)	Edge Trim Colors

#### SAMPLE ORDER CODE

<b>HTWV 24</b>	<b>48</b>	<b>AN</b>	<b>RS</b>	<b>F</b>	<b>LW</b>	<b>8</b>	<b>ST</b>
----------------	-----------	-----------	-----------	----------	-----------	----------	-----------

#### DIMENSIONS INCHES / MM

D	W
48 / 1219	46 / 1168
48 / 1219	47 / 1194
48 / 1219	48 / 1219
48 / 1219	49 / 1245
48 / 1219	50 / 1270
48 / 1219	51 / 1295
48 / 1219	52 / 1321
48 / 1219	53 / 1346
48 / 1219	54 / 1372
48 / 1219	55 / 1397
48 / 1219	56 / 1422
48 / 1219	57 / 1448
48 / 1219	58 / 1473
48 / 1219	59 / 1499
48 / 1219	60 / 1524
48 / 1219	61 / 1549
48 / 1219	62 / 1575
48 / 1219	63 / 1600
48 / 1219	64 / 1626
48 / 1219	65 / 1651
48 / 1219	66 / 1676
48 / 1219	67 / 1702
48 / 1219	68 / 1727
48 / 1219	69 / 1753
48 / 1219	70 / 1778
48 / 1219	71 / 1803
48 / 1219	72 / 1829

#### PRICING

FOUNDATION		FLINTWOOD		VENEER	
Flat Trim	Full Knife Trim	Flat Trim	Full Knife Trim	Flat Trim	Full Knife Trim
992	1279	2460	2838	2578	2974
992	1279	2460	2838	2578	2974
992	1279	2460	2838	2578	2974
1295	1675	2545	2928	2666	3068
1295	1675	2545	2928	2666	3068
1295	1675	2545	2928	2666	3068
1306	1694	2627	3016	2751	3164
1306	1694	2627	3016	2751	3164
1306	1694	2627	3016	2751	3164
1315	1707	2707	3105	2838	3255
1315	1707	2707	3105	2838	3255
1315	1707	2707	3105	2838	3255
1327	1725	2838	3257	2974	3414
1327	1725	2838	3257	2974	3414
1327	1725	2838	3257	2974	3414
1338	1741	2921	3348	3060	3511
1338	1741	2921	3348	3060	3511
1338	1741	2921	3348	3060	3511
1347	1756	3004	3437	3147	3606
1347	1756	3004	3437	3147	3606
1347	1756	3004	3437	3147	3606
1358	1775	3087	3527	3232	3698
1358	1775	3087	3527	3232	3698
1358	1775	3087	3527	3232	3698
1369	1787	3170	3619	3320	3793
1369	1787	3170	3619	3320	3793
1369	1787	3170	3619	3320	3793

Each code includes two Worksurfaces.

If One Cut Out per Worksurface is specified, add 88

If Two Cut Outs per Worksurface are specified, add 176

**H T W V**  
**Dual Perpendicular Worksurface**  
**(Continued)**

**DIMENSIONS**  
**INCHES / MM**

**PRICING**

DIMENSIONS		FOUNDATION		FLINTWOOD		VENEER	
D	W	Flat Trim	Full Knife Trim	Flat Trim	Full Knife Trim	Flat Trim	Full Knife Trim
60 / 1524	46 / 1168	1084	1389	2745	3166	2879	3320
60 / 1524	47 / 1194	1084	1389	2745	3166	2879	3320
60 / 1524	48 / 1219	1084	1389	2745	3166	2879	3320
60 / 1524	49 / 1245	1333	1727	2838	3269	2974	3427
60 / 1524	50 / 1270	1333	1727	2838	3269	2974	3427
60 / 1524	51 / 1295	1333	1727	2838	3269	2974	3427
60 / 1524	52 / 1321	1343	1746	2930	3367	3071	3531
60 / 1524	53 / 1346	1343	1746	2930	3367	3071	3531
60 / 1524	54 / 1372	1343	1746	2930	3367	3071	3531
60 / 1524	55 / 1397	1358	1762	3021	3468	3166	3638
60 / 1524	56 / 1422	1358	1762	3021	3468	3166	3638
60 / 1524	57 / 1448	1358	1762	3021	3468	3166	3638
60 / 1524	58 / 1473	1369	1780	3116	3573	3267	3744
60 / 1524	59 / 1499	1369	1780	3116	3573	3267	3744
60 / 1524	60 / 1524	1369	1780	3116	3573	3267	3744
60 / 1524	61 / 1549	1381	1800	3300	3795	3456	3977
60 / 1524	62 / 1575	1381	1800	3300	3795	3456	3977
60 / 1524	63 / 1600	1381	1800	3300	3795	3456	3977
60 / 1524	64 / 1626	1395	1816	3391	3896	3553	4083
60 / 1524	65 / 1651	1395	1816	3391	3896	3553	4083
60 / 1524	66 / 1676	1395	1816	3391	3896	3553	4083
60 / 1524	67 / 1702	1408	1835	3485	3998	3648	4188
60 / 1524	68 / 1727	1408	1835	3485	3998	3648	4188
60 / 1524	69 / 1753	1408	1835	3485	3998	3648	4188
60 / 1524	70 / 1778	1418	1853	3576	4098	3746	4294
60 / 1524	71 / 1803	1418	1853	3576	4098	3746	4294
60 / 1524	72 / 1829	1418	1853	3576	4098	3746	4294
72 / 1829	46 / 1168	1476	1941	2988	3435	3128	3602
72 / 1829	47 / 1194	1476	1941	2988	3435	3128	3602
72 / 1829	48 / 1219	1476	1941	2988	3435	3128	3602
72 / 1829	49 / 1245	2076	2732	3089	3547	3236	3717
72 / 1829	50 / 1270	2076	2732	3089	3547	3236	3717
72 / 1829	51 / 1295	2076	2732	3089	3547	3236	3717
72 / 1829	52 / 1321	2092	2751	3279	3781	3437	3962
72 / 1829	53 / 1346	2092	2751	3279	3781	3437	3962
72 / 1829	54 / 1372	2092	2751	3279	3781	3437	3962
72 / 1829	55 / 1397	2104	2772	3383	3894	3545	4081
72 / 1829	56 / 1422	2104	2772	3383	3894	3545	4081
72 / 1829	57 / 1448	2104	2772	3383	3894	3545	4081
72 / 1829	58 / 1473	2120	2792	3485	4006	3648	4198
72 / 1829	59 / 1499	2120	2792	3485	4006	3648	4198
72 / 1829	60 / 1524	2120	2792	3485	4006	3648	4198
72 / 1829	61 / 1549	2131	2812	3585	4120	3756	4317
72 / 1829	62 / 1575	2131	2812	3585	4120	3756	4317
72 / 1829	63 / 1600	2131	2812	3585	4120	3756	4317
72 / 1829	64 / 1626	2147	2829	3777	4351	3957	4559
72 / 1829	65 / 1651	2147	2829	3777	4351	3957	4559
72 / 1829	66 / 1676	2147	2829	3777	4351	3957	4559
72 / 1829	67 / 1702	2160	2850	3880	4465	4065	4678
72 / 1829	68 / 1727	2160	2850	3880	4465	4065	4678
72 / 1829	69 / 1753	2160	2850	3880	4465	4065	4678
72 / 1829	70 / 1778	2176	2869	3979	4579	4168	4797
72 / 1829	71 / 1803	2176	2869	3979	4579	4168	4797
72 / 1829	72 / 1829	2176	2869	3979	4579	4168	4797

Each code includes two Worksurfaces.  
If One Cut Out per Worksurface is specified, add 88  
If Two Cut Outs per Worksurface are specified, add 176

# worksurfaces & supports

**HTWW**

## Dual Perpendicular with Radius Corner Worksurface

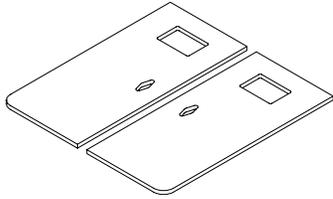

The Dual Perpendicular with Radius Corner Worksurface provides a range of depths to support both primary, secondary and single sided worksurface applications.

### WHAT'S INCLUDED

2 worksurfaces.

### NOTES

Dimensions are actual width, allowance for gaps at side edges must be specified. The number and location of Cut Outs vary, refer to the Application Guides for more details. Worksurfaces include only a cut out in the worksurface. When Rectangular Cut Out (RN, RC, RL) is specified, a Rectangular Grommet (HTEG) must be ordered separately. When Access Door Cut Out (AN, AC, AL) is specified, a kit of products including the Access Door for Multi-Circuit Desk (HTEA), Multi-Circuit Desk Housing (HTEN), Multi-Circuit Desk Power Module (HTEM), Receptacle Outlet (HTERO) and a Stage to Dual Worksurface Support Kit (HTWB) must be specified separately.

### PRODUCT OPTIONS

Depth	Width (in 1" increments)	Access Door Cut Out	Rectangle Cut Out	Worksurface Profile	Corner Profile	Worksurface Finish	Edge Trim Styles	Edge Trim Finishes
48, 60, 72	46 - 71	<b>AN</b> No Access Door Cut Out <b>AS</b> Stage Access Door Cut Out	<b>RN</b> No Rectangle Cut Out <b>RS</b> Stage Rectangle Cut Out <b>RC</b> Center Rectangle Cut Out	<b>F</b> Flush <b>W</b> Wire Gap	<b>F</b> Four Round 3" Radius <b>T</b> Two Round 3" Radius Left	Foundation Laminate Flintwood Natural Veneer	<b>8</b> Flat (Foundation Laminate) <b>9</b> Flat (Flintwood, Natural Veneer) <b>H</b> Full Knife (Foundation Laminate, Flintwood, Natural Veneer)	Edge Trim Colors

### SAMPLE ORDER CODE

<b>HTWW 72</b>	<b>48</b>	<b>AN</b>	<b>RL</b>	<b>F</b>	<b>R</b>	<b>LW</b>	<b>8</b>	<b>ST</b>
----------------	-----------	-----------	-----------	----------	----------	-----------	----------	-----------

### DIMENSIONS INCHES / MM

D	W
48 / 1219	46 / 1168
48 / 1219	47 / 1194
48 / 1219	48 / 1219
48 / 1219	49 / 1245
48 / 1219	50 / 1270
48 / 1219	51 / 1295
48 / 1219	52 / 1321
48 / 1219	53 / 1346
48 / 1219	54 / 1372
48 / 1219	55 / 1397
48 / 1219	56 / 1422
48 / 1219	57 / 1448
48 / 1219	58 / 1473
48 / 1219	59 / 1499
48 / 1219	60 / 1524
48 / 1219	61 / 1549
48 / 1219	62 / 1575
48 / 1219	63 / 1600
48 / 1219	64 / 1626
48 / 1219	65 / 1651
48 / 1219	66 / 1676
48 / 1219	67 / 1702
48 / 1219	68 / 1727
48 / 1219	69 / 1753
48 / 1219	70 / 1778
48 / 1219	71 / 1803
48 / 1219	72 / 1828

### PRICING

FOUNDATION		FLINTWOOD		VENEER	
Flat Trim	Full Knife Trim	Flat Trim	Full Knife Trim	Flat Trim	Full Knife Trim
992	1279	2460	2838	2578	2974
992	1279	2460	2838	2578	2974
992	1279	2460	2838	2578	2974
1295	1675	2545	2928	2666	3068
1295	1675	2545	2928	2666	3068
1295	1675	2545	2928	2666	3068
1306	1694	2627	3016	2751	3164
1306	1694	2627	3016	2751	3164
1306	1694	2627	3016	2751	3164
1315	1707	2707	3105	2838	3255
1315	1707	2707	3105	2838	3255
1315	1707	2707	3105	2838	3255
1327	1725	2838	3257	2974	3414
1327	1725	2838	3257	2974	3414
1327	1725	2838	3257	2974	3414
1338	1741	2921	3348	3060	3511
1338	1741	2921	3348	3060	3511
1338	1741	2921	3348	3060	3511
1347	1756	3004	3437	3147	3606
1347	1756	3004	3437	3147	3606
1347	1756	3004	3437	3147	3606
1358	1775	3087	3527	3232	3698
1358	1775	3087	3527	3232	3698
1358	1775	3087	3527	3232	3698
1369	1787	3170	3619	3320	3793
1369	1787	3170	3619	3320	3793
1369	1787	3170	3619	3320	3793

If Access Door Cut Out is specified, add 175 for each  
 If Rectangular Cut Out is specified, add 175 for each  
 If One Cut Out per Worksurface is specified, add 88  
 If Two Cut Outs per Worksurface are specified, add 176

Pricing is continued on the following page.

H T W W

Dual Perpendicular with Radius  
Corner Worksurface (Continued)

DIMENSIONS  
INCHES / MM

PRICING

DIMENSIONS		FOUNDATION		FLINTWOOD		VENEER	
D	W	Flat Trim	Full Knife Trim	Flat Trim	Full Knife Trim	Flat Trim	Full Knife Trim
60 / 1524	46 / 1168	1084	1389	2745	3166	2879	3320
60 / 1524	47 / 1194	1084	1389	2745	3166	2879	3320
60 / 1524	48 / 1219	1084	1389	2745	3166	2879	3320
60 / 1524	49 / 1245	1333	1727	2838	3269	2974	3427
60 / 1524	50 / 1270	1333	1727	2838	3269	2974	3427
60 / 1524	51 / 1295	1333	1727	2838	3269	2974	3427
60 / 1524	52 / 1321	1343	1746	2930	3367	3071	3531
60 / 1524	53 / 1346	1343	1746	2930	3367	3071	3531
60 / 1524	54 / 1372	1343	1746	2930	3367	3071	3531
60 / 1524	55 / 1397	1358	1762	3021	3468	3166	3638
60 / 1524	56 / 1422	1358	1762	3021	3468	3166	3638
60 / 1524	57 / 1448	1358	1762	3021	3468	3166	3638
60 / 1524	58 / 1473	1369	1780	3116	3573	3267	3744
60 / 1524	59 / 1499	1369	1780	3116	3573	3267	3744
60 / 1524	60 / 1524	1369	1780	3116	3573	3267	3744
60 / 1524	61 / 1549	1381	1800	3300	3795	3456	3977
60 / 1524	62 / 1575	1381	1800	3300	3795	3456	3977
60 / 1524	63 / 1600	1381	1800	3300	3795	3456	3977
60 / 1524	64 / 1626	1395	1816	3391	3896	3553	4083
60 / 1524	65 / 1651	1395	1816	3391	3896	3553	4083
60 / 1524	66 / 1676	1395	1816	3391	3896	3553	4083
60 / 1524	67 / 1702	1408	1835	3485	3998	3648	4188
60 / 1524	68 / 1727	1408	1835	3485	3998	3648	4188
60 / 1524	69 / 1753	1408	1835	3485	3998	3648	4188
60 / 1524	70 / 1778	1418	1853	3576	4098	3746	4294
60 / 1524	71 / 1803	1418	1853	3576	4098	3746	4294
60 / 1524	72 / 1828	1418	1853	3576	4098	3746	4294
72 / 1829	46 / 1168	1476	1941	2988	3435	3128	3602
72 / 1829	47 / 1194	1476	1941	2988	3435	3128	3602
72 / 1829	48 / 1219	1476	1941	2988	3435	3128	3602
72 / 1829	49 / 1245	2076	2732	3089	3547	3236	3717
72 / 1829	50 / 1270	2076	2732	3089	3547	3236	3717
72 / 1829	51 / 1295	2076	2732	3089	3547	3236	3717
72 / 1829	52 / 1321	2092	2751	3279	3781	3437	3962
72 / 1829	53 / 1346	2092	2751	3279	3781	3437	3962
72 / 1829	54 / 1372	2092	2751	3279	3781	3437	3962
72 / 1829	55 / 1397	2104	2772	3383	3894	3545	4081
72 / 1829	56 / 1422	2104	2772	3383	3894	3545	4081
72 / 1829	57 / 1448	2104	2772	3383	3894	3545	4081
72 / 1829	58 / 1473	2120	2792	3485	4006	3648	4198
72 / 1829	59 / 1499	2120	2792	3485	4006	3648	4198
72 / 1829	60 / 1524	2120	2792	3485	4006	3648	4198
72 / 1829	61 / 1549	2131	2812	3585	4120	3756	4317
72 / 1829	62 / 1575	2131	2812	3585	4120	3756	4317
72 / 1829	63 / 1600	2131	2812	3585	4120	3756	4317
72 / 1829	64 / 1626	2147	2829	3777	4351	3957	4559
72 / 1829	65 / 1651	2147	2829	3777	4351	3957	4559
72 / 1829	66 / 1676	2147	2829	3777	4351	3957	4559
72 / 1829	67 / 1702	2160	2850	3880	4465	4065	4678
72 / 1829	68 / 1727	2160	2850	3880	4465	4065	4678
72 / 1829	69 / 1753	2160	2850	3880	4465	4065	4678
72 / 1829	70 / 1778	2176	2869	3979	4579	4168	4797
72 / 1829	71 / 1803	2176	2869	3979	4579	4168	4797
72 / 1829	72 / 1828	2176	2869	3979	4579	4168	4797

If Access Door Cut Out is specified, add 175 for each  
 If Rectangular Cut Out is specified, add 175 for each  
 If One Cut Out per Worksurface is specified, add 88  
 If Two Cut Outs per Worksurface are specified, add 176

# worksurfaces & supports

## HTWG

### End Worksurface

The End Worksurface provides a range of depths to support the end of stage application.

#### WHAT'S INCLUDED

1 worksurface.

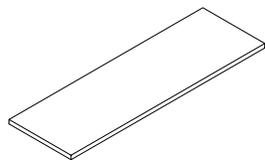

#### PRODUCT OPTIONS

Depth	Width	Worksurface Finish	Edge Trim Styles	Edge Trim Finishes
16	50, 62, 74	Foundation Laminate Flintwood Natural Veneer	<b>8</b> Flat (Foundation Laminate) <b>9</b> Flat (Flintwood, Natural Veneer) <b>H</b> Full Knife (Foundation Laminate, Flintwood, Natural Veneer)	Edge Trim Colors

#### SAMPLE ORDER CODE

<b>HTWG 16</b>	<b>50</b>	<b>LW</b>	<b>8</b>	<b>ST</b>
----------------	-----------	-----------	----------	-----------

#### DIMENSIONS INCHES / MM

D	W
16 / 406	50 / 1270
16 / 406	62 / 1575
16 / 406	74 / 1880

#### PRICING

FOUNDATION		FLINTWOOD		VENEER	
Flat Trim	Full Knife Trim	Flat Trim	Full Knife Trim	Flat Trim	Full Knife Trim
381	532	927	1002	944	1021
402	565	986	1067	1007	1090
481	672	1172	1266	1192	1287

The End Worksurface with Radius Corners provides a range of depths to support the end of stage application.

**WHAT'S INCLUDED**  
1 worksurface.

**HTWZ**  
**End with Radius Corners**  
**Worksurface**

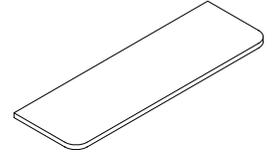

**PRODUCT OPTIONS**

Depth	Width	Corner Profile	Worksurface Finish	Edge Trim Styles	Edge Trim Finishes
16	50, 62, 74	<b>T</b> Two Round 3" Radius Left	Foundation Laminate Flintwood Natural Veneer	<b>8</b> Flat (Foundation Laminate) <b>9</b> Flat (Flintwood, Natural Veneer) <b>H</b> Full Knife (Foundation Laminate, Flintwood, Natural Veneer)	Edge Trim Colors

**SAMPLE ORDER CODE**

<b>HTWZ 16</b>	<b>50</b>	<b>T</b>	<b>LW</b>	<b>8</b>	<b>ST</b>
----------------	-----------	----------	-----------	----------	-----------

**DIMENSIONS**  
**INCHES / MM**

D	W
16 / 406	50 / 1270
16 / 406	62 / 1575
16 / 406	74 / 1880

**PRICING**

FOUNDATION		FLINTWOOD		VENEER	
Flat Trim	Full Knife Trim	Flat Trim	Full Knife Trim	Flat Trim	Full Knife Trim
381	532	927	1002	944	1021
402	565	986	1067	1007	1090
481	672	1172	1266	1192	1287

# worksurfaces & supports

**H T W T**

## Interpret Style Table

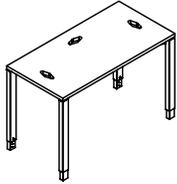

The Interpret Style Table is designed for use in freestanding applications. Available in a Fixed, Height-Adjustable and Casters options.

### WHAT'S INCLUDED

1 worksurface, reinforcing bar(s) (if applicable), power/data cut out(s), mounting hardware.

### NOTES

Grommets must be ordered separately.

The number and location of grommets vary, refer Application Guide for details.

Height-Adjustability range is +3"/-3".

Worksurfaces include only a cut out in the worksurface. When Rectangular Cut Out (RN, RC) is specified, a Rectangular Grommet (HTEG) must be ordered separately.

### PRODUCT OPTIONS

Base	Depth	Width	Rectangle Cut Out	Leg Finish	Surface Finish	Edge Trim Styles	Edge Trim Finishes
<b>C</b> Fixed Leg with Casters	23, 29, 35	46, 52, 58, 64, 70	<b>RN</b> No Rectangle Cut Out	Foundation	Foundation Laminate	<b>8</b> Flat (Foundation Laminate)	Edge Trim Colors
<b>F</b> Fixed Leg			Mica	Flintwood	<b>9</b> Flat (Flintwood, Natural Veneer)		
<b>H</b> Height-Adjustable Leg			Accent	Natural Veneer	<b>H</b> Full Knife (Foundation Laminate, Flintwood, Natural Veneer)		

### SAMPLE ORDER CODE

<b>HTWT H</b>	<b>35</b>	<b>52</b>	<b>RC</b>	<b>74</b>	<b>LW</b>	<b>8</b>	<b>ST</b>
---------------	-----------	-----------	-----------	-----------	-----------	----------	-----------

### DIMENSIONS INCHES / MM

D	W
23 / 584	46 / 1168
23 / 584	52 / 1321
23 / 584	58 / 1473
23 / 584	64 / 1626
29 / 737	52 / 1321
29 / 737	58 / 1473
29 / 737	64 / 1626
29 / 737	70 / 1778
35 / 889	52 / 1321
35 / 889	58 / 1473
35 / 889	64 / 1626
35 / 889	70 / 1778

### PRICING

#### FIXED LEG WITH CASTERS (C)

FOUNDATION		FLINTWOOD		VENEER	
Flat Trim	Full Knife Trim	Flat Trim	Full Knife Trim	Flat Trim	Full Knife Trim
1446	1590	2180	2370	2240	2437
1609	1802	2269	2463	2330	2537
1621	1821	2378	2588	2444	2666
1633	1838	2462	2680	2534	2764
1626	1829	2420	2639	2490	2720
1644	1848	2515	2744	2590	2830
1657	1868	2657	2909	2739	3004
1674	1890	2751	3013	2835	3111
1999	2330	2594	2847	2673	2937
2018	2353	2699	2960	2781	3059
2034	2375	2850	3137	2939	3242
2050	2400	2954	3252	3048	3362

If Accent/Mica Legs is specified, add 58

If Cut Out is specified, add 46

Pricing is continued on the following page.



**H T W T**  
**Interpret Style Table (Continued)**

**DIMENSIONS**  
**INCHES / MM**

D	W
23 / 584	46 / 1168
23 / 584	52 / 1321
23 / 584	58 / 1473
23 / 584	64 / 1626
29 / 737	52 / 1321
29 / 737	58 / 1473
29 / 737	64 / 1626
29 / 737	70 / 1778
35 / 889	52 / 1321
35 / 889	58 / 1473
35 / 889	64 / 1626
35 / 889	70 / 1778

**PRICING**

FIXED LEG (F)							
FOUNDATION		FLINTWOOD		VENEER			
Flat Trim	Full Knife Trim	Flat Trim	Full Knife Trim	Flat Trim	Full Knife Trim		
1189	1332	1922	2111	1982	2179		
1351	1544	2012	2206	2073	2280		
1363	1564	2120	2329	2186	2408		
1376	1580	2205	2421	2276	2506		
1368	1570	2162	2381	2232	2462		
1386	1591	2258	2486	2333	2572		
1400	1610	2398	2652	2480	2745		
1416	1632	2494	2755	2578	2853		
1741	2073	2337	2589	2416	2680		
1760	2096	2442	2702	2524	2801		
1777	2117	2592	2879	2682	2984		
1792	2141	2696	2993	2790	3105		

HEIGHT-ADJUSTABLE LEG (H)							
FOUNDATION		FLINTWOOD		VENEER			
Flat Trim	Full Knife Trim	Flat Trim	Full Knife Trim	Flat Trim	Full Knife Trim		
1246	1389	1980	2169	2041	2237		
1409	1602	2070	2263	2131	2337		
1421	1621	2178	2388	2244	2466		
1433	1637	2262	2479	2335	2563		
1426	1628	2220	2440	2290	2521		
1444	1649	2315	2545	2390	2630		
1457	1668	2456	2710	2538	2803		
1474	1689	2552	2813	2636	2910		
1800	2131	2395	2646	2473	2737		
1817	2154	2500	2760	2582	2859		
1835	2176	2650	2937	2740	3042		
1850	2200	2754	3052	2848	3163		

If Accent/Mica Legs is specified, add 58

If Cut Out is specified, add 46

# worksurfaces & supports

## HTWU

### Interpret Style Radius Corner Table

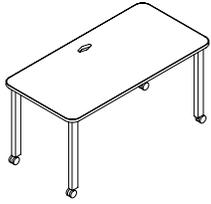

The Interpret Style with Radius Corners Table is designed for use in freestanding applications. Available in a Fixed, Height-Adjustable and Casters options.

#### WHAT'S INCLUDED

1 worksurface, reinforcing bar(s) (if applicable), power/data cut out(s), mounting hardware.

#### NOTES

Worksurface is designed to accompany the upStage Infinity Curved Desk Edge Screen GXCU. Grommets must be ordered separately. The number and location of grommets vary, refer Application Guide for details.

Height-Adjustability range is +3"/-3".

Worksurfaces include only a cut out in the worksurface. When Rectangular Cut Out (RN, RC) is specified, a Rectangular Grommet (HTEG) must be ordered separately.

#### PRODUCT OPTIONS

Base	Depth	Width	Corner Profile	Rectangle Cut Out	Leg Finish	Worksurface Finish	Edge Trim Styles	Edge Trim Finishes
<b>C</b> Fixed Leg with Casters	23, 29, 35	46, 52, 58, 64, 70	<b>T</b> Two Round 3" Radius Left	<b>RN</b> No Rectangle Cut Out <b>RC</b> Center Rectangle Cut Out	Foundation Mica Accent	Foundation Laminate Flintwood Natural Veneer	<b>8</b> Flat (Foundation Laminate) <b>9</b> Flat (Flintwood, Natural Veneer) <b>H</b> Full Knife (Foundation Laminate, Flintwood, Natural Veneer)	Edge Trim Colors

#### SAMPLE ORDER CODE

<b>HTWU H</b>	<b>35</b>	<b>64</b>	<b>T</b>	<b>RC</b>	<b>74</b>	<b>LW</b>	<b>8</b>	<b>ST</b>
---------------	-----------	-----------	----------	-----------	-----------	-----------	----------	-----------

#### DIMENSIONS INCHES / MM

D	W
23 / 584	46 / 1168
23 / 584	52 / 1321
23 / 584	58 / 1473
23 / 584	64 / 1626
29 / 737	52 / 1321
29 / 737	58 / 1473
29 / 737	64 / 1626
29 / 737	70 / 1778
35 / 889	52 / 1321
35 / 889	58 / 1473
35 / 889	64 / 1626
35 / 889	70 / 1778

#### PRICING

##### FIXED LEG WITH CASTERS (C)

FOUNDATION		FLINTWOOD		VENEER	
Flat Trim	Full Knife Trim	Flat Trim	Full Knife Trim	Flat Trim	Full Knife Trim
1446	1590	2180	2370	2240	2437
1609	1802	2269	2463	2330	2537
1621	1821	2378	2588	2444	2666
1633	1838	2462	2680	2534	2764
1626	1829	2420	2639	2490	2720
1644	1848	2515	2744	2590	2830
1657	1868	2657	2909	2739	3004
1674	1890	2751	3013	2835	3111
1999	2330	2594	2847	2673	2937
2018	2353	2699	2960	2781	3059
2034	2375	2850	3137	2939	3242
2050	2400	2954	3252	3048	3362

If Accent/Mica Legs is specified, add 58

If Cut Out is specified, add 46

Pricing is continued on the following page.

H T W U

Interpret Style Radius Corner Table  
(Continued)

DIMENSIONS  
INCHES / MM

D	W
23 / 584	46 / 1168
23 / 584	52 / 1321
23 / 584	58 / 1473
23 / 584	64 / 1626
29 / 737	52 / 1321
29 / 737	58 / 1473
29 / 737	64 / 1626
29 / 737	70 / 1778
35 / 889	52 / 1321
35 / 889	58 / 1473
35 / 889	64 / 1626
35 / 889	70 / 1778

PRICING

FIXED LEG (F)					
FOUNDATION		FLINTWOOD		VENEER	
Flat Trim	Full Knife Trim	Flat Trim	Full Knife Trim	Flat Trim	Full Knife Trim
1189	1332	1922	2111	1982	2179
1351	1544	2012	2206	2073	2280
1363	1564	2120	2329	2186	2408
1376	1580	2205	2421	2276	2506
1368	1570	2162	2381	2232	2462
1386	1591	2258	2486	2333	2572
1400	1610	2398	2652	2480	2745
1416	1632	2494	2755	2578	2853
1741	2073	2337	2589	2416	2680
1760	2096	2442	2702	2524	2801
1777	2117	2592	2879	2682	2984
1792	2141	2696	2993	2790	3105

HEIGHT-ADJUSTABLE LEG (H)					
FOUNDATION		FLINTWOOD		VENEER	
Flat Trim	Full Knife Trim	Flat Trim	Full Knife Trim	Flat Trim	Full Knife Trim
1246	1389	1980	2169	2041	2237
1409	1602	2070	2263	2131	2337
1421	1621	2178	2388	2244	2466
1433	1637	2262	2479	2335	2563
1426	1628	2220	2440	2290	2521
1444	1649	2315	2545	2390	2630
1457	1668	2456	2710	2538	2803
1474	1689	2552	2813	2636	2910
1800	2131	2395	2646	2473	2737
1817	2154	2500	2760	2582	2859
1835	2176	2650	2937	2740	3042
1850	2200	2754	3052	2848	3163

If Accent/Mica Legs is specified, add 58  
If Cut Out is specified, add 46

## HTWN

### Interpret Style Leg



Right Shown

The Interpret Style Leg is available with a Fixed and a Height-Adjustable option that provides a Intermediate fixed or height-adjustable to worksurface support as an alternative to Mid Gable or Cantilever.

#### WHAT'S INCLUDED

1 leg, attachment hardware

#### NOTES

The Leg is used in combination with other stage or with storage based supports or legs to create a semi supported or freestanding table.

Handedness is determined by the user perspective from when seated at the worksurface.

Height-Adjustability range is +3"/-3".

#### PRODUCT OPTIONS

Style	Left/Right	Finish
<b>F</b> Fixed	<b>L</b> Left	Foundation
<b>H</b> Height-Adjustable	<b>R</b> Right	Mica Accent

#### SAMPLE ORDER CODE

<b>HTWN F</b>	<b>R</b>	<b>74</b>
---------------	----------	-----------

#### PRICING

FIXED (F)		HEIGHT-ADJUSTABLE (H)	
Foundation	Accent/Mica	Foundation	Accent/Mica
163	180	180	194

The Interpret Style Mono Leg is available with a Fixed and a Height-Adjustable option that provides a intermediate fixed or height-adjustable to worksurface support as an alternative to a Mid Gable or Cantilever.

**HTWM**  
**Interpret Style Mono Leg**

**WHAT'S INCLUDED**

1 leg, attachment hardware

**NOTES**

Height-Adjustability range is +3"/-3".

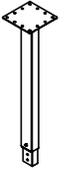

**PRODUCT OPTIONS**

Style	Finish
F Fixed	Foundation Mica Accent
H Height-Adjustable	

**SAMPLE ORDER CODE**

<b>HTWM F</b>	<b>74</b>
---------------	-----------

**PRICING**

FIXED (F)		HEIGHT-ADJUSTABLE (H)	
Foundation	Accent/Mica	Foundation	Accent/Mica
163	180	180	194

# worksurfaces & supports

## HTWE

### Y Table

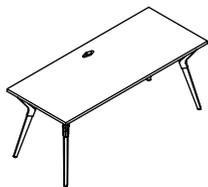

The Y Table is designed for use in freestanding applications.

#### WHAT'S INCLUDED

1 worksurface, reinforcing bar(s) (if applicable), center rectangle cut out (if specified), 4 Y legs and mounting hardware.

#### NOTES

Worksurfaces include only a cut out in the worksurface. When Rectangular Cut Out (RN, RC, RL) is specified, a Rectangular Grommet (HTEG) must be ordered separately.

#### PRODUCT OPTIONS

Base	Depth	Width	Rectangle Cut Out	Upper Support Finish	Lower Support Finish	Surface Finish	Edge Trim Styles	Edge Trim Finishes
<b>W</b> Wood & Metal	23, 29, 35	46, 52, 58, 64, 70	<b>RN</b> No Rectangle Cut Out	Foundation	Foundation	Foundation Laminate	<b>8</b> Flat (Foundation Laminate) <b>9</b> Flat (Flintwood, Natural Veneer)	Edge Trim Colors
<b>M</b> Metal & Metal			<b>RC</b> Center Rectangle Cut Out	Mica Accent	Mica Accent Flintwood Natural Veneer	Flintwood Natural Veneer		

#### SAMPLE ORDER CODE

<b>HTWE H</b>	<b>23</b>	<b>64</b>	<b>RC</b>	<b>74</b>	<b>MP</b>	<b>LW</b>	<b>9</b>	<b>ST</b>
---------------	-----------	-----------	-----------	-----------	-----------	-----------	----------	-----------

#### DIMENSIONS INCHES / MM

D	W
23 / 584	46 / 1168
23 / 584	52 / 1321
23 / 584	58 / 1473
23 / 584	64 / 1626
29 / 737	52 / 1321
29 / 737	58 / 1473
29 / 737	64 / 1626
29 / 737	70 / 1778
35 / 889	52 / 1321
35 / 889	58 / 1473
35 / 889	64 / 1626
35 / 889	70 / 1778

#### PRICING

##### METAL & METAL (M)

Foundation	Flintwood	Veneer
1575	2310	2370
1738	2398	2460
1750	2507	2574
1762	2591	2664
1755	2549	2619
1773	2644	2719
1786	2786	2868
1803	2880	2965
2129	2724	2802
2147	2829	2910
2163	2980	3068
2179	3083	3177

##### METAL & WOOD (W)

Foundation	Flintwood	Veneer
1875	2609	2669
2039	2698	2760
2050	2807	2873
2062	2892	2963
2055	2849	2920
2073	2945	3019
2086	3086	3167
2103	3180	3265
2428	3023	3102
2447	3128	3211
2463	3279	3368
2479	3383	3478

If Mica on Leg is specified, add 58

If Cut Out is specified, add 45

The Y Table Radius Corner is designed for use in freestanding applications.

**HTWX**

**Y Table Radius Corner**

**WHAT'S INCLUDED**

1 worksurface, reinforcing bar(s) (if applicable), center rectangle cut out (if specified), 4 Y legs and mounting hardware.

**NOTES**

Worksurface is designed to accompany the upStage Infinity Curved Desk Edge Screen GXCU. Worksurfaces include only a cut out in the worksurface. When Rectangular Cut Out (RN, RC, RL) is specified, a Rectangular Grommet (HTEG) must be ordered separately



**PRODUCT OPTIONS**

Base	Depth	Width	Corner Profile	Rectangle Cut Out	Upper Support Finish	Lower Support Finish	Worksurface Finish	Edge Trim Styles	Edge Trim Finishes
<b>W</b> Metal and Wood	23, 29, 35	46, 52, 58, 64, 70	<b>R</b> Round 3" Radius	<b>RN</b> No Rectangle Cut Out	Foundation	Foundation	Foundation Laminate	<b>8</b> Flat (Foundation Laminate)	Edge Trim Colors
<b>M</b> Metal and Metal					Mica	Mica	Flintwood		
				<b>RC</b> Center Rectangle Cut Out	Accent	Accent	Natural Veneer	<b>9</b> Flat (Flintwood, Natural Veneer)	

**SAMPLE ORDER CODE**

<b>HTWX W</b>	<b>23</b>	<b>64</b>	<b>R</b>	<b>RC</b>	<b>74</b>	<b>MP</b>	<b>LW</b>	<b>9</b>	<b>ST</b>
---------------	-----------	-----------	----------	-----------	-----------	-----------	-----------	----------	-----------

**DIMENSIONS  
INCHES / MM**

D	W
23 / 584	46 / 1168
23 / 584	52 / 1321
23 / 584	58 / 1473
23 / 584	64 / 1626
29 / 737	52 / 1321
29 / 737	58 / 1473
29 / 737	64 / 1626
29 / 737	70 / 1778
35 / 889	52 / 1321
35 / 889	58 / 1473
35 / 889	64 / 1626
35 / 889	70 / 1778

**PRICING**

METAL & METAL (M)			METAL & WOOD (W)		
Foundation	Flintwood	Veneer	Foundation	Flintwood	Veneer
1575	2310	2370	1875	2609	2669
1738	2398	2460	2039	2698	2760
1750	2507	2574	2050	2807	2873
1762	2591	2664	2062	2892	2963
1755	2549	2619	2055	2849	2920
1773	2644	2719	2073	2945	3019
1786	2786	2868	2086	3086	3167
1803	2880	2965	2103	3180	3265
2129	2724	2802	2428	3023	3102
2147	2829	2910	2447	3128	3211
2163	2980	3068	2463	3279	3368
2179	3083	3177	2479	3383	3478

If Mica on Leg, is specified, add 58

If Cut Out is specified, add 45

# worksurfaces & supports

## HTWD

### Y Leg

The Y Leg provides an intermediate worksurface support as an alternative to a Mid Gable or Cantilever.

#### WHAT'S INCLUDED

1 leg, attachment hardware.



#### PRODUCT OPTIONS

Style	Upper Support Finish	Lower Support Finish
<b>W</b> Wood & Metal	Foundation	Foundation
<b>M</b> Metal & Metal	Mica	Mica
	Accent	Accent
		Flintwood
		Natural Veneer

#### SAMPLE ORDER CODE

<b>HTWD W</b>	<b>74</b>	<b>MP</b>
---------------	-----------	-----------

#### PRICING

##### METAL & METAL (M)

Foundation	Accent/Mica
263	276

##### WOOD & METAL (W)

Foundation	Accent/Mica
337	349



The Stage to Worksurface Support is used to attach worksurfaces to the Stage.

**WHAT'S INCLUDED**

2 brackets and attachment hardware.

**NOTES**

Height-Adjustability range is +3"/-3".

**HTWQ**  
**Stage to Worksurface Support**

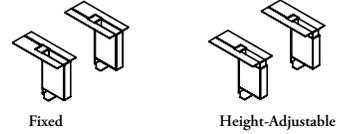

**PRODUCT OPTIONS**

Style	Finish
F Fixed	Foundation Mica Accent
H Height-Adjustable	

**SAMPLE ORDER CODE**

<b>HTWQ H</b>	<b>74</b>
---------------	-----------

**PRICING**

FIXED (F)		HEIGHT-ADJUSTABLE (H)	
Foundation	Accent/Mica	Foundation	Accent/Mica
268	281	311	330

## HTWS

### Storage Back to Worksurface Support

The Storage Back to Worksurface Support is used to attach worksurfaces to storage.

#### WHAT'S INCLUDED

2 brackets and attachment hardware.

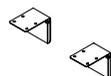

Two Height-Adjustable Brackets

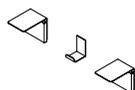

Two Height-Adjustable Brackets, One Hook

#### PRODUCT OPTIONS

Style	Finish
<b>H</b> Two Height-Adjustable Brackets	Foundation Mica Accent
<b>B</b> Two Height-Adjustable Brackets, One Hook	

#### SAMPLE ORDER CODE

<b>HTWS H</b>	<b>74</b>
---------------	-----------

#### PRICING

97
----

The Credenza to Worksurface Support mounts to the underside of a worksurface and to the top of a credenza to provide support for the worksurface.

**HTWC**

**Credenza to Worksurface Support**

**WHAT'S INCLUDED**

Brackets, as specified and attachment hardware.

**NOTES**

Adjustment range is +3"/-1" (28" - 32" worksurface height).



**PRODUCT OPTIONS**

Style	Finish
F Fixed	Foundation Mica Accent
H Height-Adjustable	

**SAMPLE ORDER CODE**

<b>HTWC F</b>	<b>74</b>
---------------	-----------

**PRICING**

FIXED (F)		HEIGHT-ADJUSTABLE (H)	
Foundation	Accent/Mica	Foundation	Accent/Mica
210	216	240	247

# worksurfaces & supports

**H T W B**

## Stage to Dual Worksurface Support Kit

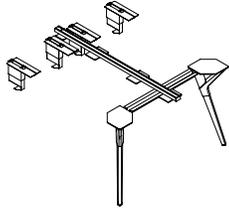

The Stage to Dual Worksurface Support Kit mounts to the underside of a worksurface and to the Stage to provide support for the worksurface.

**WHAT'S INCLUDED**

Brackets, as specified and attachment hardware.

This support kit is designed to accompany the Dual Perpendicular Worksurface (HTWW) and the Dual Perpendicular Radius Worksurface (HTWW).

**PRODUCT OPTIONS**

Support Style	Depth of Worksurface	Width of Worksurface (in 1" increments)	Application	Leg Style	Accessory Beam Finish	Support Finish	Upper Support Finish	Lower Support Finish
<b>H</b> Height-Adjustable	48, 60, 72	46 - 73	<b>S</b> Standard <b>E</b> With Elevated Storage	<b>N</b> No Leg	Foundation Mica Accent	Foundation Mica Accent	Foundation Mica Accent	Foundation Mica Accent Flintwood Natural Veneer
				<b>F</b> Fixed				
				<b>H</b> Height-Adjustable				
				<b>W</b> Y Leg Metal and Wood <b>M</b> Y Leg Metal and Metal				

**SAMPLE ORDER CODE**

<b>HTWB H</b>	<b>48</b>	<b>50</b>	<b>S</b>	<b>W</b>	<b>74</b>	<b>74</b>	<b>74</b>	<b>MP</b>
---------------	-----------	-----------	----------	----------	-----------	-----------	-----------	-----------

**DIMENSIONS  
INCHES / MM**

**PRICING**

D	W	NO LEG (N)		FIXED (F)		HEIGHT-ADJUSTABLE (H)		Y LEG METAL & WOOD (W)		Y LEG METAL & METAL (M)	
		Foundation	Accent/Mica	Foundation	Accent/Mica	Foundation	Accent/Mica	Foundation	Accent/Mica	Foundation	Accent/Mica
48 / 1219	46 / 1168	854	888	1182	1248	1211	1281	1526	1590	1376	1439
48 / 1219	47 / 1194	854	888	1182	1248	1211	1281	1526	1590	1376	1439
48 / 1219	48 / 1219	854	888	1182	1248	1211	1281	1526	1590	1376	1439
48 / 1219	49 / 1245	858	891	1188	1251	1215	1285	1529	1594	1380	1444
48 / 1219	50 / 1270	858	891	1188	1251	1215	1285	1529	1594	1380	1444
48 / 1219	51 / 1295	858	891	1188	1251	1215	1285	1529	1594	1380	1444
48 / 1219	52 / 1321	861	897	1191	1255	1221	1288	1536	1598	1385	1447
48 / 1219	53 / 1346	861	897	1191	1255	1221	1288	1536	1598	1385	1447
48 / 1219	54 / 1372	861	897	1191	1255	1221	1288	1536	1598	1385	1447
48 / 1219	55 / 1397	861	897	1191	1255	1221	1288	1536	1598	1385	1447
48 / 1219	56 / 1422	861	897	1191	1255	1221	1288	1536	1598	1385	1447
48 / 1219	57 / 1448	861	897	1191	1255	1221	1288	1536	1598	1385	1447
48 / 1219	58 / 1473	861	897	1191	1255	1221	1288	1536	1598	1385	1447
48 / 1219	59 / 1499	861	897	1191	1255	1221	1288	1536	1598	1385	1447
48 / 1219	60 / 1524	864	899	1195	1257	1223	1293	1538	1600	1387	1449
48 / 1219	61 / 1549	864	899	1195	1257	1223	1293	1538	1600	1387	1449
48 / 1219	62 / 1575	864	899	1195	1257	1223	1293	1538	1600	1387	1449
48 / 1219	63 / 1600	864	899	1195	1257	1223	1293	1538	1600	1387	1449
48 / 1219	64 / 1626	864	899	1195	1257	1223	1293	1538	1600	1387	1449
48 / 1219	65 / 1651	864	899	1195	1257	1223	1293	1538	1600	1387	1449
48 / 1219	66 / 1676	868	902	1197	1259	1226	1295	1540	1603	1389	1453
48 / 1219	67 / 1702	868	902	1197	1259	1226	1295	1540	1603	1389	1453
48 / 1219	68 / 1727	868	902	1197	1259	1226	1295	1540	1603	1389	1453
48 / 1219	69 / 1753	868	902	1197	1259	1226	1295	1540	1603	1389	1453
48 / 1219	70 / 1778	871	906	1200	1263	1228	1298	1543	1605	1393	1457
48 / 1219	71 / 1803	871	906	1200	1263	1228	1298	1543	1605	1393	1457
48 / 1219	72 / 1829	874	910	1203	1266	1232	1302	1546	1609	1395	1460

If Mica Upper Leg finish is specified, for Fixed Leg or Y-Leg, add 63 for Height-Adjustable Leg, add 69

Pricing is continued on the following page.

**H T W B**  
**Stage to Dual Worksurface**  
**Support Kit (Continued)**

**DIMENSIONS**  
**INCHES / MM**

**PRICING**

D		W		NO LEG (N)		FIXED (F)		HEIGHT ADJUSTABLE (H)		Y LEG METAL & WOOD (W)		Y LEG METAL & METAL (M)	
				Foundation	Accent/Mica	Foundation	Accent/Mica	Foundation	Accent/Mica	Foundation	Accent/Mica	Foundation	Accent/Mica
60 / 1524	46 / 1168	872	907	1202	1264	1230	1299	1544	1607	1394	1459		
60 / 1524	47 / 1194	872	907	1202	1264	1230	1299	1544	1607	1394	1459		
60 / 1524	48 / 1219	872	907	1202	1264	1230	1299	1544	1607	1394	1459		
60 / 1524	49 / 1245	876	912	1205	1268	1234	1304	1549	1611	1398	1463		
60 / 1524	50 / 1270	876	912	1205	1268	1234	1304	1549	1611	1398	1463		
60 / 1524	51 / 1295	876	912	1205	1268	1234	1304	1549	1611	1398	1463		
60 / 1524	52 / 1321	882	916	1210	1274	1237	1309	1552	1618	1404	1467		
60 / 1524	53 / 1346	882	916	1210	1274	1237	1309	1552	1618	1404	1467		
60 / 1524	54 / 1372	882	916	1210	1274	1237	1309	1552	1618	1404	1467		
60 / 1524	55 / 1397	882	916	1210	1274	1237	1309	1552	1618	1404	1467		
60 / 1524	56 / 1422	882	916	1210	1274	1237	1309	1552	1618	1404	1467		
60 / 1524	57 / 1448	882	916	1210	1274	1237	1309	1552	1618	1404	1467		
60 / 1524	58 / 1473	882	916	1210	1274	1237	1309	1552	1618	1404	1467		
60 / 1524	59 / 1499	882	916	1210	1274	1237	1309	1552	1618	1404	1467		
60 / 1524	60 / 1524	884	918	1213	1276	1242	1311	1556	1620	1407	1469		
60 / 1524	61 / 1549	884	918	1213	1276	1242	1311	1556	1620	1407	1469		
60 / 1524	62 / 1575	884	918	1213	1276	1242	1311	1556	1620	1407	1469		
60 / 1524	63 / 1600	884	918	1213	1276	1242	1311	1556	1620	1407	1469		
60 / 1524	64 / 1626	884	918	1213	1276	1242	1311	1556	1620	1407	1469		
60 / 1524	65 / 1651	884	918	1213	1276	1242	1311	1556	1620	1407	1469		
60 / 1524	66 / 1676	887	921	1215	1280	1244	1313	1558	1622	1409	1471		
60 / 1524	67 / 1702	887	921	1215	1280	1244	1313	1558	1622	1409	1471		
60 / 1524	68 / 1727	887	921	1215	1280	1244	1313	1558	1622	1409	1471		
60 / 1524	69 / 1753	887	921	1215	1280	1244	1313	1558	1622	1409	1471		
60 / 1524	70 / 1778	889	924	1219	1282	1249	1316	1562	1626	1411	1475		
60 / 1524	71 / 1803	889	924	1219	1282	1249	1316	1562	1626	1411	1475		
60 / 1524	72 / 1829	891	927	1222	1285	1251	1318	1566	1628	1415	1477		
72 / 1829	46 / 1168	890	925	1221	1283	1250	1317	1564	1627	1414	1476		
72 / 1829	47 / 1194	890	925	1221	1283	1250	1317	1564	1627	1414	1476		
72 / 1829	48 / 1219	890	925	1221	1283	1250	1317	1564	1627	1414	1476		
72 / 1829	49 / 1245	895	929	1225	1287	1253	1323	1568	1630	1417	1480		
72 / 1829	50 / 1270	895	929	1225	1287	1253	1323	1568	1630	1417	1480		
72 / 1829	51 / 1295	895	929	1225	1287	1253	1323	1568	1630	1417	1480		
72 / 1829	52 / 1321	899	935	1228	1293	1257	1327	1572	1634	1421	1486		
72 / 1829	53 / 1346	899	935	1228	1293	1257	1327	1572	1634	1421	1486		
72 / 1829	54 / 1372	899	935	1228	1293	1257	1327	1572	1634	1421	1486		
72 / 1829	55 / 1397	899	935	1228	1293	1257	1327	1572	1634	1421	1486		
72 / 1829	56 / 1422	899	935	1228	1293	1257	1327	1572	1634	1421	1486		
72 / 1829	57 / 1448	899	935	1228	1293	1257	1327	1572	1634	1421	1486		
72 / 1829	58 / 1473	899	935	1228	1293	1257	1327	1572	1634	1421	1486		
72 / 1829	59 / 1499	899	935	1228	1293	1257	1327	1572	1634	1421	1486		
72 / 1829	60 / 1524	902	937	1232	1295	1259	1329	1574	1637	1424	1489		
72 / 1829	61 / 1549	902	937	1232	1295	1259	1329	1574	1637	1424	1489		
72 / 1829	62 / 1575	902	937	1232	1295	1259	1329	1574	1637	1424	1489		
72 / 1829	63 / 1600	902	937	1232	1295	1259	1329	1574	1637	1424	1489		
72 / 1829	64 / 1626	902	937	1232	1295	1259	1329	1574	1637	1424	1489		
72 / 1829	65 / 1651	902	937	1232	1295	1259	1329	1574	1637	1424	1489		
72 / 1829	66 / 1676	906	941	1234	1298	1263	1333	1577	1642	1427	1491		
72 / 1829	67 / 1702	906	941	1234	1298	1263	1333	1577	1642	1427	1491		
72 / 1829	68 / 1727	906	941	1234	1298	1263	1333	1577	1642	1427	1491		
72 / 1829	69 / 1753	906	941	1234	1298	1263	1333	1577	1642	1427	1491		
72 / 1829	70 / 1778	910	943	1236	1302	1266	1335	1580	1644	1431	1494		
72 / 1829	71 / 1803	910	943	1236	1302	1266	1335	1580	1644	1431	1494		
72 / 1829	72 / 1829	912	947	1241	1304	1268	1338	1582	1648	1434	1497		

If Mica Upper Leg finish is specified, for Fixed Leg or Y-Leg, add 63  
for Height-Adjustable Leg, add 69

## HTWJ

### End Worksurface Support Kit

The End Worksurface Support mounts to the underside of an End worksurface and to the Stage to provide support for the worksurface.

#### WHAT'S INCLUDED

Brackets, as specified and attachment hardware.

This support kit is designed to accompany the End Worksurface (HTWG) and the End Worksurface with Radius Corner (HTWZ).

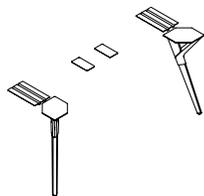

#### PRODUCT OPTIONS

Depth of Worksurface	Width of Worksurface	Leg Style	Leg Support Finish	Lower Y Leg Support Finish
16	50, 62, 74	<b>F</b> Fixed <b>H</b> Height-Adjustable <b>W</b> Y Leg Metal and Wood <b>M</b> Y Leg Metal and Metal	Foundation Mica Accent	Foundation Mica Accent Flintwood Natural Veneer

#### SAMPLE ORDER CODE

<b>HTWJ 16</b>	<b>62</b>	<b>W</b>	<b>74</b>	<b>MP</b>
----------------	-----------	----------	-----------	-----------

#### PRICING

FIXED (F)		HEIGHT-ADJUSTABLE (H)		Y LEG METAL & WOOD (W)		Y LEG METAL & METAL (M)	
Foundation	Accent/Mica	Foundation	Accent/Mica	Foundation	Accent/Mica	Foundation	Accent/Mica
453	482	482	517	796	824	646	675

The Hutch to Worksurface Support mounts to the underside of a worksurface and to the Hutch to provide support for the worksurface.

**WHAT'S INCLUDED**

Brackets, as specified and attachment hardware.

**HTWF**  
**Hutch to Worksurface Support**

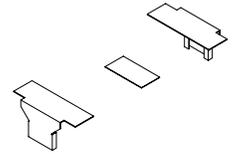

**PRODUCT OPTIONS**

Support Style	Style of Hutch	Width of Hutch	Depth of Worksurface	Finish
F Fixed	S Single D Shared Y Aperture	30, 36, 42, 48, 54, 60, 66, 72	24, 30, 36, 42, 48	Foundation Mica Accent

**SAMPLE ORDER CODE**

<b>HTWF F</b>	<b>Y</b>	<b>60</b>	<b>30</b>	<b>74</b>
---------------	----------	-----------	-----------	-----------

**PRICING**

---



---

113

---

## HTWY

### Worksurface Support Wire Manager

The Worksurface Support Wire Manager is an add on to the worksurface support that provides additional wire management from the worksurface and the stage.

**WHAT'S INCLUDED**

1 wire management support.

**NOTES**

Wire Manager is designed to use the same connection fasteners that accompany the Stage to Worksurface support (HTWQ).



**PRODUCT OPTIONS**

Support Style	Finish
Q Stage to Worksurface Support	Foundation Mica Accent

**SAMPLE ORDER CODE**

HTWY Q	74
--------	----

**PRICING**

**STAGE TO WORKSURFACE SUPPORT (Q)**

Foundation	Accent/Mica
44	53



The Flush Plate is used in conjunction with other supports to maintain alignment of the worksurfaces.

## HTWA Flush Plate

**WHAT'S INCLUDED**

1 flush plate, attachment hardware.

**NOTES**

Structural Flush Plate option.

Finished in Ebony.

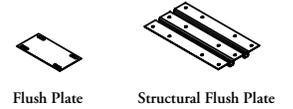

**PRODUCT OPTIONS**

Style
F Flush
R Structural Flush Plate

**SAMPLE ORDER CODE**

**HTWA F**

**PRICING**

FLUSH (F)	STRUCTURAL FLUSH PLATE (R)
48	61

## UNRC

### Worksurface Reinforcement Channel

The Worksurface Reinforcement Channel adds rigidity to worksurfaces.

#### WHAT'S INCLUDED

1 reinforced channel, attachment hardware.

#### NOTES

Finished in Ebony.

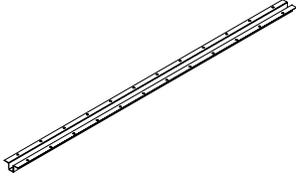

#### PRODUCT OPTIONS

Width  
(6" increments)

36 - 96

#### SAMPLE ORDER CODE

UNRC 60

#### DIMENSIONS INCHES / MM

W
36 / 914
42 / 1067
48 / 1219
54 / 1372
60 / 1524
66 / 1676
72 / 1829
78 / 1981
84 / 2134
90 / 2286
96 / 2438

#### PRICING

31
33
35
39
43
48
51
53
57
59
61



height-adjustability

# product map

## H T B H Single Stage Module for HA Table

Page 304



## H T B D Double Stage Module for HA Table

Page 305



## Y G U Navigate Height-Adjustable Built-In Base

One Table  
One Plug

Page 306

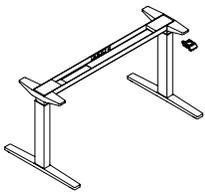

## Y V U Navigate Height-Adjustable Built-in Gable Base

One Table  
One Plug

Page 308

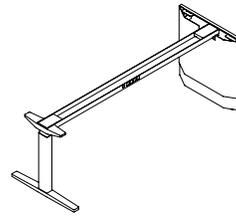

## Y S U hiSpace Height-Adjustable Built-In Base with Quick Connect

Page 310

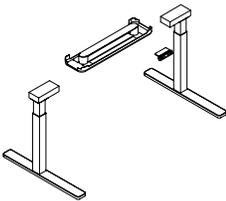

## W B U Rectangular Height-Adjustable Worksurface, Gable

Page 312

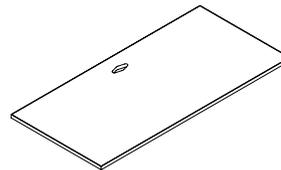

## W J U Rectangular Height-Adjustable Worksurface with Radius Corners

Page 316



## W B A hiSpace Rectangular Height-Adjustable Worksurface

Page 318

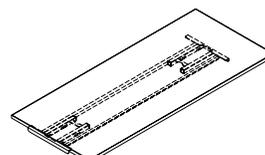

## product map

**W J B** hiSpace Rectangular Height-Adjustable Worksurface with Radius Corners for Quick Connect

Page 319

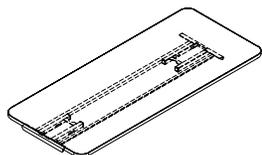

**H T S C C** Double Credenza for Height-Adjustable Table

Page 320

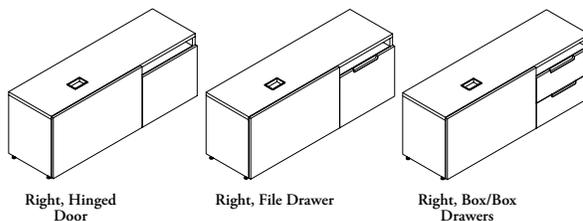

Right, Hinged Door

Right, File Drawer

Right, Box/Box Drawers

---

**H T S C T** Triple Credenza for Height-Adjustable Table

Page 322

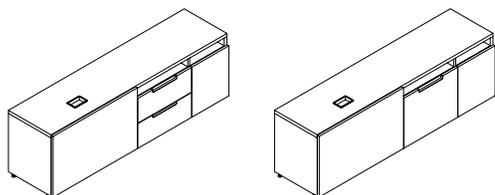

Right, Box, Box/Hinged Door

Right, File/Hinged Door

**H T S C D** Height-Adjustable Integrated Double Credenza

Page 324

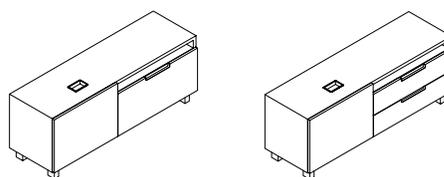

Right, File

Right, Box, Box

---

**H T S C P** Height-Adjustable Integrated Triple Credenza

Page 326

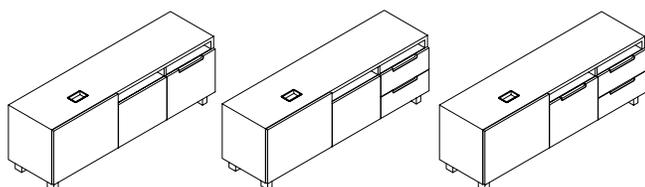

Right, Hinged Door/File

Right, Hinged Door/Box, Box

Left, File/ Box, Box



# height-adjustability

## HTBH

### Single Stage Module for HA Table

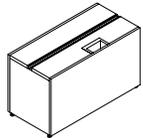

With Accessory Beam (HiSpace)

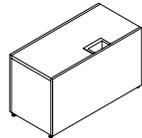

Without Accessory Beam

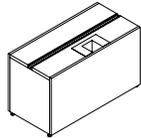

With Accessory Beam (Navigate)

The Single Stage Module for Height-Adjustable Table is placed in between Stages, or at the end of a Stage run. It conceals power and data wiring and creates a physical enclosure between adjustable legs down to the floor. Designed to accompany Navigate Height-Adjustable Built-In Base (YGU).

#### WHAT'S INCLUDED

1 stage with optional accessory beam, single or double side power and infeed grommet.

#### NOTES

Specify the width of the module 6" larger than the depth of the Height-Adjustable Table.

With both Single and Double Sided Power options selected the related electrical components must be specified separately.

If Accessory Beam option is selected, Stage Accessory Beam Cover (HTBR) must be specified separately.

When Infeed Grommets are specified, Grommet Covers are included.

#### PRODUCT OPTIONS

HA Table	Height	Depth	Width	Accessory Beam	Infeed Grommet	Left/Right	Base Finish	Front Finish	Metal Finish	Leg Grommet Finish
NV Navigate	21	16	30, 36	Y Yes	Y1 Yes, One Grommet	R Right	Source Laminate	Source Laminate	Foundation	Foundation
HQ hiSpace				N No	Y2 Yes, Two Grommet	L Left	Flintwood	Flintwood	Mica Accent	Mica Accent
					NA No Grommet		Natural Veneer	Natural Veneer		

#### SAMPLE ORDER CODE

HTBH NV	21	16	36	Y	Y2	L	XG	ZI	74	74
---------	----	----	----	---	----	---	----	----	----	----

#### DIMENSIONS INCHES / MM

H	D	W
21 / 533	16 / 406	30 / 762
21 / 533	16 / 406	36 / 914

21 / 533	16 / 406	30 / 762
21 / 533	16 / 406	36 / 914

#### PRICING

##### WITHOUT ACCESSORY BEAM (N)

BASE FINISH			FRONT FINISH		
Source Laminate	Flintwood	Natural Veneer	Source Laminate	Flintwood	Natural Veneer
642	1610	1688	201	495	515
660	1645	1727	211	533	557

##### WITH ACCESSORY BEAM (Y)

BASE FINISH			FRONT FINISH		
Source Laminate	Flintwood	Natural Veneer	Source Laminate	Flintwood	Natural Veneer
731	1829	1921	201	495	515
768	1921	2016	211	533	557

If Accent/Mica is specified with one infeed grommet, add 6

If Accent/Mica is specified with two infeed grommets, add 14



The Double Stage Module for Height-Adjustable Table is placed in between Stages, or at the end of a Stage run. It conceals power and data wiring and creates a physical enclosure between adjustable legs down to the floor. Designed to accompany Navigate Height-Adjustable Built-In Base (YGU).

## HTBD Double Stage Module for HA Table

### WHAT'S INCLUDED

1 stage with optional accessory beam, single or double side power and infeed grommet.

### NOTES

Specific the width of the module 6" larger than the depth of the Height-Adjustable Table.

With both Single and Double Sided Power options selected the related electrical components must be specified separately.

If Accessory Beam option is selected, Stage Accessory Beam Cover (HTBR) must be specified separately.

When Infeed Grommets are specified, Grommet Covers are included.

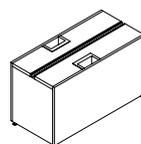

With Accessory Beam (HiSpace)

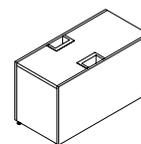

Without Accessory Beam

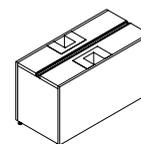

With Accessory Beam (Navigate)

### PRODUCT OPTIONS

HA Table	Height	Depth	Width	Accessory Beam	Infeed Grommet	Base Finish	Front Finish	Metal Finish	Leg Grommet Finish
NV Navigate	21	16	30, 36	Y Yes	Y1 Yes, One Grommet	Source Laminate	Source Laminate	Foundation	Foundation
HQ hiSpace				N No	Y2 Yes Two Grommet	Flintwood	Flintwood	Mica	Mica
					NA No Grommet	Natural Veneer	Natural Veneer	Accent	Accent

### SAMPLE ORDER CODE

HTBD NV	21	16	36	Y	Y1	XG	ZI	74	74
---------	----	----	----	---	----	----	----	----	----

### DIMENSIONS INCHES / MM

H	D	W
21 / 533	16 / 406	30 / 762
21 / 533	16 / 406	36 / 914

### PRICING

#### WITHOUT ACCESSORY BEAM (N)

BASE FINISH			FRONT FINISH		
Source Laminate	Flintwood	Natural Veneer	Source Laminate	Flintwood	Natural Veneer
694	1738	1823	198	495	515
711	1775	1862	211	533	557

#### WITH ACCESSORY BEAM (Y)

BASE FINISH			FRONT FINISH		
Source Laminate	Flintwood	Natural Veneer	Source Laminate	Flintwood	Natural Veneer
782	1957	2052	198	495	515
820	2048	2149	211	533	557

If Accent/Mica is specified with one infeed grommet, add 6

If Accent/Mica is specified with two infeed grommets, add 14

# height-adjustability

## Y G U

### Navigate Height-Adjustable Built-In Base

One Table  
One Plug

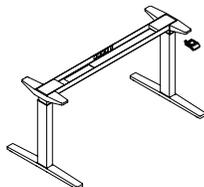

Navigate Height-Adjustable Built-In Base is for use with upStage Modules and Credenzas for Height-Adjustable Tables.

#### WHAT'S INCLUDED

1 electric height-adjustable table base, leg and foot configuration as specified.

#### NOTES

Electric base mechanism has 0.1 Watt resting power draw and uses 120V North American control box.

For Switch details, see the Application Guide section.

Vertical Wire Carrier includes Cross-Channel bracket and mounts into Module.

Cross Channel Integrated Powerbar option (C) includes 3 outlets + 1 IEC Connection. This IEC connection accepts only one IEC-compatible power accessory (with an IEC cord terminal) at a time.

Undersurface cable management option (5) - Dual Plastic Trays + Powerbar with IEC refers to a Power Rod (with IEC cord terminal) that must be plugged into the IEC connection of the Cross Channel Integrated Powerbar option (C).

For more information about the One Table One Plug electrical system, IEC-compatible power accessories and planning with IEC Connection, refer to Complements: *Teknion's Ergonomics & Accessories Program*.

#### PRODUCT OPTIONS

Leg Application		Base Mechanism	Actual Depth	Actual Width	Foot Style
<b>TML</b>	T-Legs (Left Leg Corridor, Right Leg Stage Module)	<b>7S</b> Standard Range Electric (27" - 43")	25, 30	53, 59, 65, 71, 77, 83	<b>1</b> Standard
<b>TMR</b>	T-Legs (Right Leg Corridor, Left Leg Stage Module)				
<b>TCL</b>	T-Legs (Left Leg Credenza, Right Leg Stage Module)	<b>9C</b> Extended Electric-Restricted (25" - 48.7")			
<b>TCR</b>	T-Legs (Right Leg Credenza, Left Leg Stage Module)				
<b>PTL</b>	Post and T-Leg (Left Post Credenza, Right Leg Stage Module)				
<b>PTR</b>	Post and T-Leg (Right Post Credenza, Left Leg Stage Module)				

#### SAMPLE ORDER CODE

<b>YGU TML</b>	<b>9C</b>	<b>30</b>	<b>65</b>	<b>1</b>
----------------	-----------	-----------	-----------	----------

#### PRODUCT OPTIONS (CONTINUED)

Base Finish	Switch Style	Switch Finish	Powerbar	Undersurface Cable Management	Vertical Wire Carrier (Optional)
Foundation	<b>S</b> Standard Up/Down	<b>E</b> Ebony Coordinate	<b>N</b> None	<b>N</b> None	<b>N</b> None
Mica	<b>D</b> Display with Up/Down Memory	<b>X</b> Anthracite	<b>I</b> Cross Channel Integrated - 4 Outlets	<b>1</b> Cable Organizer with Felt Cover	<b>E</b> Ebony Coordinate
Accent		<b>7</b> Platinum			<b>7</b> Platinum Coordinate
	<b>T</b> Toggle Up/Down	<b>6</b> Crisp Grey	<b>C</b> Cross Channel Integrated - 3 Outlets +1 IEC	<b>3</b> Dual Plastic Trays and Powerbar	<b>V</b> Very White Coordinate
	<b>X</b> Display toggle with Memory and Navigate GPS				
				<b>5</b> Dual Plastic Trays + Powerbar with IEC	

#### SAMPLE ORDER CODE (CONTINUED)

<b>52</b>	<b>X</b>	<b>X</b>	<b>I</b>	<b>1</b>	<b>N</b>
-----------	----------	----------	----------	----------	----------

See Pricing on the following page.

**Navigate Height-Adjustable  
Built-In Base (Continued)**

**DIMENSIONS  
INCHES / MM**

D	W
25 / 635	53 / 1346
25 / 635	59 / 1499
25 / 635	65 / 1651
25 / 635	71 / 1803
25 / 635	77 / 1956
25 / 635	83 / 2108
30 / 762	53 / 1346
30 / 762	59 / 1499
30 / 762	65 / 1651
30 / 762	71 / 1803
30 / 762	77 / 1956
30 / 762	83 / 2108

D	W
25 / 635	53 / 1346
25 / 635	59 / 1499
25 / 635	65 / 1651
25 / 635	71 / 1803
25 / 635	77 / 1956
25 / 635	83 / 2108
30 / 762	53 / 1346
30 / 762	59 / 1499
30 / 762	65 / 1651
30 / 762	71 / 1803
30 / 762	77 / 1956
30 / 762	83 / 2108

**PRICING**

**STANDARD RANGE ELECTRIC BASE MECHANISM (7S)**

Foundation	Mica/Accent
3352	3457
3352	3457
3389	3494
3389	3494
3389	3494
3389	3494
3352	3457
3352	3457
3389	3494
3389	3494
3389	3494
3389	3494

**EXTENDED ELECTRIC-RESTRICTED RANGE BASE MECHANISM (9C)**

Foundation	Mica/Accent
3579	3684
3579	3684
3593	3699
3593	3699
3593	3699
3593	3699
3579	3684
3579	3684
3593	3699
3593	3699
3593	3699
3593	3699

- If Display with Up/Down Memory (D) switch is specified, add 184
- If Display Toggle with Memory and Navigate GPS (X) switch is specified, add 184
- If Dual Plastic Trays are specified, add 59
- If Dual Plastic Trays + Powerbar is specified, add 285
- If Cable Organizer with Felt Cover is specified, add 292
- If Cross Channel Integrated Powerbar - 4 Outlets (I) or 3 Outlets + 1 IEC (C) with No Cable Management is specified, add 247
- If Cross Channel Integrated Powerbar - 4 Outlets (I) or 3 Outlets + 1 IEC (C) + Dual Plastic Trays are specified, add 308
- If Cross Channel Integrated Powerbar - 4 Outlets (I) + Dual Plastic Trays + Powerbar are specified, add 533
- If Cross Channel Integrated Powerbar - 3 Outlets + 1 IEC (C) + Dual Plastic Trays + Powerbar with IEC are specified, add 605
- If Cross Channel Integrated Powerbar - 4 Outlets (I) or 3 Outlets + 1 IEC (C) + Cable Organizer with Felt Cover is specified, add 541
- If Vertical Wire Carrier is specified, add 334

# height-adjustability

## Y V U

### Navigate Height-Adjustable Built-in Gable Base

One Table  
One Plug

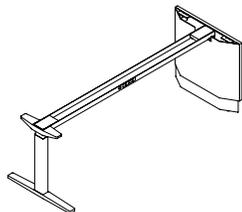

Navigate Height-Adjustable Built-In Gable Base is to be paired with Rectangular Height-Adjustable Worksurface Gable to create a specific upStage integrated Height-Adjustable Table.

#### WHAT'S INCLUDED

1 electric height-adjustable base, leg and foot configuration as specified, integrated Vertical Wire Carrier Cable Manager.

#### NOTES

Electric base mechanism has 0.1 Watt resting power draw and uses 120V North American control box.

For Switch details, see the Application Guide section.

Vertical Wire Carrier includes Cross-Channel bracket and mounts into Module.

The height-adjustable worksurface must be specified separately.

Cross Channel Integrated Powerbar option (C) includes 3 outlets + 1 IEC Connection. This IEC connection accepts only one IEC-compatible power accessory (with an IEC cord terminal) at a time.

Undersurface cable management option (5) - Dual Plastic Trays + Powerbar with IEC refers to a Power Rod (with IEC cord terminal) that must be plugged into the IEC connection of the Cross Channel Integrated Powerbar option (C).

For more information about the One Table One Plug electrical system, IEC-compatible power accessories and planning with IEC Connection, refer to Complements: Teknion's Ergonomics & Accessories Program.

#### PRODUCT OPTIONS

Leg Application	Base Mechanism	Actual Depth	Actual Width	Base Finish
<b>GTL</b> Gable & T-Leg (L Gable Corr, R Leg Stage Module)	<b>7S</b> Standard Range Electric (27" - 43")	30	47, 53, 59, 65, 71, 77, 83	Foundation
<b>GTR</b> Gable & T-Leg (R Gable Corr, L Leg Stage Module)				Mica Accent
	<b>9C</b> Extended Electric-Restricted (25" - 48.7")			

#### SAMPLE ORDER CODE

<b>YVU GTL</b>	<b>9C</b>	<b>30</b>	<b>65</b>	<b>52</b>
----------------	-----------	-----------	-----------	-----------

#### PRODUCT OPTIONS (CONTINUED)

Water Fall Finish	Switch Style	Switch Finish	Powerbar	Undersurface Cable Management	Vertical Wire Carrier (Optional)
Foundation	<b>S</b> Standard Up/Down	<b>E</b> Ebony Coordinate	<b>N</b> None	<b>N</b> None	<b>N</b> None
Flintwood	<b>D</b> Display with Up/Down Memory	<b>X</b> Anthracite	<b>I</b> Cross Channel Integrated - 4 Outlets	<b>1</b> Cable Organizer with Felt Cover	<b>E</b> Ebony Coordinate
Natural Veneer	<b>T</b> Toggle Up/Down	<b>7</b> Platinum	<b>C</b> Cross Channel Integrated - 3 Outlets +1 IEC	<b>3</b> Dual Plastic Trays and Powerbar	<b>7</b> Platinum Coordinate
	<b>X</b> Display toggle with Memory and Navigate GPS	<b>6</b> Crisp Grey		<b>4</b> Dual Plastic Trays	<b>V</b> Very White Coordinate
				<b>5</b> Dual Plastic Trays + Powerbar with IEC	

#### SAMPLE ORDER CODE (CONTINUED)

<b>VZ</b>	<b>X</b>	<b>X</b>	<b>I</b>	<b>1</b>	<b>N</b>
-----------	----------	----------	----------	----------	----------

See Pricing on the following page.

Y V U

**Navigate Height-Adjustable Built-in Gable Base (Continued)**

**DIMENSIONS  
INCHES / MM**

D	W
30 / 762	47 / 1194
30 / 762	53 / 1346
30 / 762	59 / 1499
30 / 762	65 / 1651
30 / 762	71 / 1803
30 / 762	77 / 1956
30 / 762	83 / 2108

D	W
30 / 762	47 / 1194
30 / 762	53 / 1346
30 / 762	59 / 1499
30 / 762	65 / 1651
30 / 762	71 / 1803
30 / 762	77 / 1956
30 / 762	83 / 2108

**PRICING**

**STANDARD RANGE ELECTRIC BASE MECHANISM (7S)**

Foundation	Mica/Accent
4938	5044
4997	5103
5031	5137
5110	5215
5152	5258
5258	5364
5311	5418

**EXTENDED ELECTRIC-RESTRICTED RANGE BASE MECHANISM (9C)**

Foundation	Mica/Accent
5333	5439
5394	5500
5433	5537
5515	5619
5597	5665
5707	5775
5767	5832

If Flintwood Water Fall Finish is specified,

47" Width:	830
53" Width	793
59" Width	872
65" Width	997
71" Width	1078
77" Width	851
83" Width	929

If Veneer Water Fall Finish is specified,

47" Width:	897
53" Width	863
59" Width	948
65" Width	1078
71" Width	1163
77" Width	942
83" Width	1024

If Display with Up/Down Memory (D) switch is specified, add 184

If Display Toggle with Memory and Navigate GPS (X) switch is specified, add 184

If Dual Plastic Trays are specified, add 59

If Dual Plastic Trays + Powerbar is specified, add 285

If Cable Organizer with Felt Cover is specified, add 292

If Cross Channel Integrated Powerbar - 4 Outlets (I) or 3 Outlets + 1 IEC (C) with No Cable Management is specified, add 247

If Cross Channel Integrated Powerbar - 4 Outlets (I) or 3 Outlets + 1 IEC (C) + Dual Plastic Trays are specified, add 308

If Cross Channel Integrated Powerbar - 4 Outlets (I) + Dual Plastic Trays + Powerbar are specified, add 533

If Cross Channel Integrated Powerbar - 3 Outlets + 1 IEC (C) + Dual Plastic Trays + Powerbar with IEC are specified, add 605

If Cross Channel Integrated Powerbar - 4 Outlets (I) or 3 Outlets + 1 IEC (C) + Cable Organizer with Felt Cover is specified, add 541

If Vertical Wire Carrier is specified, add 334

## Y S U

### hiSpace Height-Adjustable Built-In Base with Quick Connect

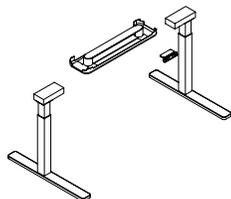

hiSpace Height-Adjustable Built-In Base is for use with upStage Modules and Credenzas for Height-Adjustable Tables.

#### WHAT'S INCLUDED

1 electric height-adjustable table base, leg and foot configuration as specified.

#### NOTES

Electric base mechanism has 0.1 Watt resting power draw and uses 120V North American control box.

For Switch details, see the Application Guide section. E-Chain includes Cross-Channel bracket and mounts into Module.

Rectangle Grommet (HTEG) must be ordered separately.

Cross Channel Integrated Powerbar option (C) includes 3 outlets + 1 IEC Connection. This IEC connection accepts only one IEC-compatible power accessory (with an IEC cord terminal) at a time.

Undersurface cable management option (3) - Dual Plastic Trays + Powerbar with IEC refers to a Power Rod (with IEC cord terminal) that must be plugged into the IEC connection of the Cross Channel Integrated Powerbar option (C).

For more information about the One Table One Plug electrical system, IEC-compatible power accessories and planning with IEC Connection, refer to Complements: Teknion's Ergonomics & Accessories Program.

#### PRODUCT OPTIONS

Leg Application	Base Mechanism	Actual Depth	Actual Width	Foot Style
<b>TML</b> T-Legs (Left Leg Corridor, Right Leg Stage Module)	<b>9U</b> Extended Electric-Restricted (25" - 51.1")	25, 30	53, 59, 65, 71	<b>1</b> Standard
<b>TMR</b> T-Legs (Right Leg Corridor, Left Leg Stage Module)				
<b>TCL</b> T-Legs (Left Leg Credenza, Right Leg Stage Module)				
<b>TCR</b> T-Legs (Right Leg Credenza, Left Leg Stage Module)				

#### SAMPLE ORDER CODE

<b>YSU TML</b>	<b>9U</b>	<b>30</b>	<b>65</b>	<b>1</b>
----------------	-----------	-----------	-----------	----------

#### PRODUCT OPTIONS (CONTINUED)

Base Finish	Switch Style	Power Pak	Undersurface Cable Management	Vertical Wire Carrier (Optional)
<b>60</b> Platinum	<b>D</b> Display with Up/Down Memory	<b>1</b> Cable Organizer with Felt Cover	<b>N</b> None	<b>N</b> None
<b>83</b> Very White				
<b>52</b> Ebony				
	<b>A</b> Toggle Display with Memory		<b>3</b> Dual Plastic Trays and Powerbar	<b>E</b> Ebony Coordinate
			<b>4</b> Dual Plastic Trays	<b>7</b> Platinum Coordinate
				<b>V</b> Very White Coordinate

#### SAMPLE ORDER CODE (CONTINUED)

<b>52</b>	<b>D</b>	<b>1</b>	<b>3</b>	<b>N</b>
-----------	----------	----------	----------	----------

See Pricing on the following page.

**Y S U**  
**hiSpace Height-Adjustable**  
**Built-In Base with Quick Connect**  
**(Continued)**

**PRICING**

No Cable Management	Dual Plastic Trays and Powerbar	Dual Plastic Trays
2049	2335	2107

If Vertical Wire Carrier (-) is specified, add 334

## W B U

### Rectangular Height-Adjustable Worksurface, Post & T Legs

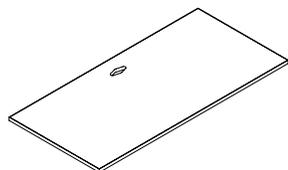

Rectangular Height-Adjustable Worksurface, Post & T Legs is to be paired with Navigate Height-Adjustable Built-In Base (YGU) to create an UpStage specific integrated Height-Adjustable table.

#### WHAT'S INCLUDED

1 worksurface.

#### NOTES

Worksurfaces only include a cut out when cut out style and location are specified.

Rectangle Grommet (HTEG) must be ordered separately.

Cut out locations are not available on the same side as a Post and T-Leg (PTL/PTR).

#### PRODUCT OPTIONS

Leg Application	Base Mechanism	Actual Depth	Actual Width
<b>TML</b> T-Legs (Left Leg Corridor, Right Leg Stage Module)	<b>7S</b> Standard Range Electric (27" - 43")	30	47, 53, 59, 65, 71, 77, 83
<b>TMR</b> T-Legs (Right Leg Corridor, Left Leg Stage Module)			
<b>TCL</b> T-Legs (Left Leg Credenza, Right Leg Stage Module)	<b>9C</b> Extended Electric-Restricted (25" - 48.6")		
<b>TCR</b> T-Legs (Right Leg Credenza, Left Leg Stage Module)			
<b>PTL</b> Post & T-Leg (Left Post Credenza, Right Leg Stage Module)			
<b>PTR</b> Post & T-Leg (Right Post Credenza, Left Leg Stage Module)			

#### SAMPLE ORDER CODE

<b>WBU GTL</b>	<b>7S</b>	<b>30</b>	<b>71</b>
----------------	-----------	-----------	-----------

#### PRODUCT OPTIONS (CONTINUED)

Cut Out Style	Cut Out Location	Surface Finish	Edge Trim Style	Edge Trim Finish
<b>N</b> None	<b>N</b> None	Foundation Laminate	<b>8</b> Flat (with Foundation)	PVC
<b>R</b> Rectangular (Diamond Shaped Cut Out)	<b>C</b> Center	Flintwood	<b>9</b> Flat (with Flintwood)	
	<b>L</b> Left	Natural Veneer	<b>9</b> Flat Edge	
	<b>R</b> Right			

#### SAMPLE ORDER CODE (CONTINUED)

<b>R</b>	<b>C</b>	<b>LW</b>	<b>8</b>	<b>ST</b>
----------	----------	-----------	----------	-----------

See Pricing on the following page.



W B U

**Rectangular Height-Adjustable  
Worksurface, Post & T Legs (Continued)**

**DIMENSIONS  
INCHES / MM**

**PRICING**

		NO CUT OUT (N)					
		FOUNDATION		FLINTWOOD		VENEER	
		Flat Trim	Full Knife Trim	Flat Trim	Full Knife Trim	Flat Trim	Full Knife Trim
25 / 635	53 / 1346	650	844	1299	1494	1361	1567
25 / 635	59 / 1499	663	859	1384	1582	1448	1659
25 / 635	65 / 1651	672	875	1489	1704	1558	1786
25 / 635	71 / 1803	684	890	1570	1793	1645	1881
25 / 635	77 / 1956	753	1002	1654	1885	1733	1975
25 / 635	83 / 2108	764	1016	1783	2035	1867	2132
30 / 762	53 / 1346	671	869	1449	1670	1520	1749
30 / 762	59 / 1499	684	887	1543	1768	1618	1855
30 / 762	65 / 1651	696	906	1680	1932	1758	2024
30 / 762	71 / 1803	708	922	1773	2031	1856	2130
30 / 762	77 / 1956	1072	1418	1909	2193	1999	2299
30 / 762	83 / 2108	1085	1437	2001	2297	2097	2405
		CENTER, LEFT OR RIGHT CUT OUT (C/L/R)					
		FOUNDATION		FLINTWOOD		VENEER	
		Flat Trim	Full Knife Trim	Flat Trim	Full Knife Trim	Flat Trim	Full Knife Trim
25 / 635	53 / 1346	696	887	1342	1538	1406	1609
25 / 635	59 / 1499	705	902	1426	1627	1492	1703
25 / 635	65 / 1651	715	918	1530	1749	1602	1830
25 / 635	71 / 1803	728	935	1614	1837	1688	1922
25 / 635	77 / 1956	796	1044	1697	1928	1778	2019
25 / 635	83 / 2108	807	1060	1826	2077	1911	2177
30 / 762	53 / 1346	713	913	1494	1711	1564	1791
30 / 762	59 / 1499	728	929	1588	1813	1659	1897
30 / 762	65 / 1651	738	949	1724	1973	1803	2067
30 / 762	71 / 1803	752	966	1815	2074	1899	2175
30 / 762	77 / 1956	1116	1463	1951	2237	2043	2342
30 / 762	83 / 2108	1129	1478	2044	2338	2140	2449

## W B U

### Rectangular Height-Adjustable Worksurface, Gable

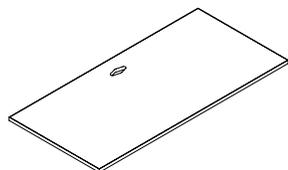

Rectangular Height-Adjustable Worksurface Gable is to be paired with Navigate Height-Adjustable Built-In Base (YGU) to create an upStage specific integrated Height-Adjustable table.

#### WHAT'S INCLUDED

1 worksurface.

#### NOTES

Worksurfaces only include a cut out when cut out style and location are specified.

Rectangle Grommet (HTEG) must be ordered separately.

#### PRODUCT OPTIONS

Leg Application	Base Mechanism	Actual Depth	Actual Width
<b>GTL</b> Left Gable Corridor , Right Leg Stage Module <b>GTR</b> Right Gable Corridor, Left Leg Stage Module	<b>7S</b> Standard Range Electric (27" - 43") <b>9C</b> Extended Electric-Restricted (25" - 48.6")	30	47, 53, 59, 65, 71, 77, 83

#### SAMPLE ORDER CODE

<b>WBU GTL</b>	<b>7S</b>	<b>30</b>	<b>71</b>
----------------	-----------	-----------	-----------

#### PRODUCT OPTIONS (CONTINUED)

Cut Out Style	Cut Out Location	Surface Finish	Edge Trim Style	Edge Trim Finish
<b>N</b> None <b>R</b> Rectangular (Diamond Shaped Cut Out)	<b>N</b> None <b>C</b> Center <b>L</b> Left <b>R</b> Right	Foundation Laminate Flintwood Natural Veneer	<b>8</b> Flat (with Foundation) <b>9</b> Flat (with Flintwood) <b>9</b> Flat Edge	PVC

#### SAMPLE ORDER CODE (CONTINUED)

<b>R</b>	<b>C</b>	<b>LW</b>	<b>8</b>	<b>ST</b>
----------	----------	-----------	----------	-----------

See Pricing on the following page.

W B U \_

**Rectangular Height-Adjustable Worksurface,  
Gable (Continued)**

**DIMENSIONS  
INCHES / MM**

30 / 762	47 / 1194
30 / 762	53 / 1346
30 / 762	59 / 1499
30 / 762	65 / 1651
30 / 762	71 / 1803
30 / 762	77 / 1956
30 / 762	83 / 2108

30 / 762	47 / 1194
30 / 762	53 / 1346
30 / 762	59 / 1499
30 / 762	65 / 1651
30 / 762	71 / 1803
30 / 762	77 / 1956
30 / 762	83 / 2108

**PRICING**

NO CUT OUT (N)		
Foundation	Flintwood	Veneer
542	1335	1398
671	1449	1520
684	1543	1618
696	1680	1758
708	1773	1856
1072	1909	1999
1085	2001	2097

CENTER (C) / LEFT (L) / RIGHT (R) CUT OUT		
Foundation	Flintwood	Veneer
583	1379	1441
713	1494	1564
728	1588	1659
738	1724	1803
752	1815	1899
1116	1951	2043
1129	2044	2140

# height-adjustability

## W J U

### Rectangular Height-Adjustable Worksurface with Radius Corners

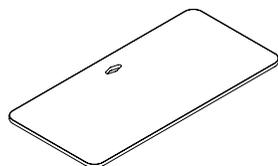

Rectangular Height-Adjustable Worksurface with Radius Corners is to be paired with Navigate Height-Adjustable Built-In Base (YGU) to create an UpStage specific integrated Height-Adjustable table that can also support curved screens.

#### WHAT'S INCLUDED

1 worksurface.

#### NOTES

Worksurfaces only include a cut out when cut out style and location are specified.

Rectangle Grommet (HTEG) must be ordered separately.

Cut Out locations are not available on the same side as a specified Post Leg (PTL and PTR).

#### PRODUCT OPTIONS

Leg Application	Base Mechanism	Actual Depth	Actual Width
<b>TML</b> T-Legs (Left Leg Corridor, Right Leg Stage Module)	<b>7S</b> Standard Range Electric (27" - 43") <b>9C</b> Extended Electric-Restricted (25" - 48.7")	25, 30	53, 59, 65, 71, 77, 83
<b>TMR</b> T-Legs (Right Leg Corridor, Left Leg Stage Module)			
<b>TCL</b> T-Legs (Left Leg Credenza, Right Leg Stage Module)			
<b>TCR</b> T-Legs (Right Leg Credenza, Left Leg Stage Module)			
<b>PTL</b> Post and T-Leg (Left Post Credenza, Right Leg Stage Module)			
<b>PTR</b> Post and T-Leg (Right Post Credenza, Left Leg Stage Module)			

#### SAMPLE ORDER CODE

<b>WJU TML</b>	<b>7S</b>	<b>30</b>	<b>71</b>
----------------	-----------	-----------	-----------

#### PRODUCT OPTIONS (CONTINUED)

Cut Out Style	Cut Out Location	Surface Finish	Edge Trim Style	Edge Trim Finish
<b>N</b> None	<b>N</b> None	Foundation Laminate	<b>8</b> Flat (with Foundation)	Edge Trim Colors
<b>R</b> Rectangular (Diamond Shaped Cut Out)	<b>C</b> Center	Flintwood	<b>9</b> Flat (with Flintwood & Natural Veneer)	
	<b>L</b> Left	Natural Veneer		
	<b>R</b> Right			

#### SAMPLE ORDER CODE (CONTINUED)

<b>R</b>	<b>C</b>	<b>LW</b>	<b>8</b>	<b>ST</b>
----------	----------	-----------	----------	-----------

See Pricing on the following page.

W J U

**Rectangular Height-Adjustable  
Worksurface with Radius Corners  
(Continued)**

**DIMENSIONS  
INCHES / MM**

**PRICING**

		FOUNDATION		FLINTWOOD		VENEER	
		Flat Trim	Full Knife Trim	Flat Trim	Full Knife Trim	Flat Trim	Full Knife Trim
25 / 635	53 / 1346	650	844	1299	1494	1361	1567
25 / 635	59 / 1499	663	859	1384	1582	1448	1659
25 / 635	65 / 1651	672	875	1489	1704	1558	1786
25 / 635	71 / 1803	684	890	1570	1793	1645	1881
25 / 635	77 / 1956	753	1002	1654	1885	1733	1975
25 / 635	83 / 2108	764	1016	1783	2035	1867	2132
30 / 762	53 / 1346	671	869	1449	1670	1520	1749
30 / 762	59 / 1499	684	887	1543	1768	1618	1855
30 / 762	65 / 1651	696	906	1680	1932	1758	2024
30 / 762	71 / 1803	708	922	1773	2031	1856	2130
30 / 762	77 / 1956	1072	1418	1909	2193	1999	2299
30 / 762	83 / 2108	1085	1437	2001	2297	2097	2405

If Cut Out is specified, add 46 for each

# height-adjustability

## W B A

### hiSpace Rectangular Height-Adjustable Worksurface

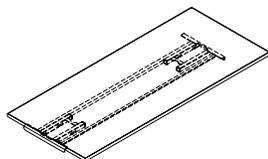

Rectangular Height-Adjustable Worksurface is to be paired with hiSpace Height-Adjustable Built-In Base (YSU) to create an upStage specific integrated Height-Adjustable table.

#### WHAT'S INCLUDED

1 worksurface with quick connect.

#### NOTES

Worksurfaces only include a cut out when cut out style and location are specified.

#### PRODUCT OPTIONS

Leg Application	Base Mechanism	Actual Depth	Actual Width
<b>TML</b> T-Legs (Left Leg Corridor, Right Leg Stage Module)	<b>9U</b> Extended Electric-with Riser (25" - 51.1")	25, 30	53, 59, 65, 71
<b>TMR</b> T-Legs (Right Leg Corridor, Left Leg Stage Module)			
<b>TCL</b> T-Legs (Left Leg Credenza, Right Leg Stage Module)			
<b>TCR</b> T-Legs (Right Leg Credenza, Left Leg Stage Module)			

#### SAMPLE ORDER CODE

<b>WBA TSL</b>	<b>9U</b>	<b>30</b>	<b>71</b>
----------------	-----------	-----------	-----------

#### PRODUCT OPTIONS (CONTINUED)

Cut Out Style	Cut Out Location	Surface Finish	Edge Trim Style	Edge Trim Finish	Connection Kit Finish
<b>N</b> None	<b>N</b> None	Foundation Laminate	<b>8</b> Flat	PVC with HPL surface only	<b>52</b> Ebony <b>60</b> Platinum <b>83</b> Very White
<b>R</b> Rectangular (Diamond Shaped Cut Out)	<b>C</b> Center				
	<b>L</b> Left				
	<b>R</b> Right				

#### SAMPLE ORDER CODE (CONTINUED)

<b>R</b>	<b>C</b>	<b>LW</b>	<b>8</b>	<b>ST</b>	<b>52</b>
----------	----------	-----------	----------	-----------	-----------

#### DIMENSIONS INCHES / MM

D	W
25 / 635	53 / 1346
25 / 635	59 / 1499
25 / 635	65 / 1651
25 / 635	71 / 1803
30 / 762	53 / 1346
30 / 635	59 / 1499
30 / 762	65 / 1651
30 / 762	71 / 1803

#### PRICING

No Cut Out	Rectangular Cut Out
756	799
766	808
776	820
789	830
775	819
789	830
800	844
812	856

Rectangular Height-Adjustable Worksurface with radius corners is to be paired with hiSpace Height-Adjustable Built-In Base (YSU) to create an upStage specific integrated Height-Adjustable table.

**WHAT'S INCLUDED**

1 worksurface with quick connect.

**NOTES**

Worksurfaces only include a cut out when cut out style and location are specified.

Rectangle Grommet (HTEG) must be ordered separately.

**W J B**

**hiSpace Rectangular Height-Adjustable Worksurface with Radius Corners for Quick Connect**

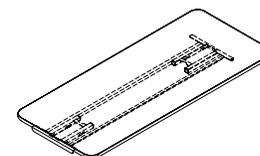

**PRODUCT OPTIONS**

Leg Application	Base Mechanism	Actual Depth	Actual Width
<b>TML</b> T-Legs (Left Leg Corridor, Right Leg Stage Module)	<b>9U</b> Extended Electric-with Riser (25" - 51.1")	25, 30	53, 59, 65, 71
<b>TMR</b> T-Legs (Right Leg Corridor, Left Leg Stage Module)			
<b>TCL</b> T-Legs (Left Leg Credenza, Right Leg Stage Module)			
<b>TCR</b> T-Legs (Right Leg Credenza, Left Leg Stage Module)			

**SAMPLE ORDER CODE**

<b>WJB TML</b>	<b>9U</b>	<b>30</b>	<b>71</b>
----------------	-----------	-----------	-----------

**PRODUCT OPTIONS (CONTINUED)**

Cut Out Style	Cut Out Location	Surface Finish	Edge Trim Style	Edge Trim Finish	Connection Kit Finish
<b>N</b> None	<b>N</b> None <b>C</b> Center <b>L</b> Left <b>R</b> Right	Foundation Laminate	<b>8</b> Flat	PVC	<b>52</b> Ebony
<b>R</b> Rectangular (Diamond Shaped Cut Out)					<b>60</b> Platinum <b>83</b> Very White

**SAMPLE ORDER CODE (CONTINUED)**

<b>R</b>	<b>C</b>	<b>LW</b>	<b>8</b>	<b>ST</b>	<b>52</b>
----------	----------	-----------	----------	-----------	-----------

**DIMENSIONS  
INCHES / MM**

D	W
25 / 635	53 / 1346
25 / 635	59 / 1499
25 / 635	65 / 1651
25 / 635	71 / 1803
30 / 762	53 / 1346
30 / 635	59 / 1499
30 / 762	65 / 1651
30 / 762	71 / 1803

**PRICING**

No Cut Out	Rectangular Cut Out
756	799
766	808
776	820
789	830
775	819
789	830
800	844
812	856

# height-adjustability

## HTSCC

### Double Credenza for Height-Adjustable Table

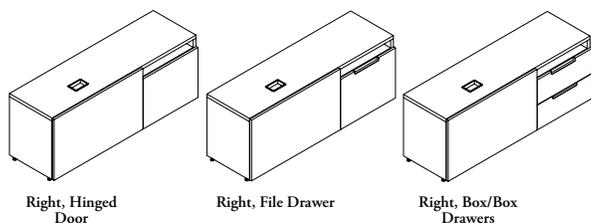

Right, Hinged Door

Right, File Drawer

Right, Box/Box Drawers

#### WHAT'S INCLUDED

Case and drawers/doors, levelers, filing accessory (if box drawers are specified), hanging bar when file drawers specified, leg grommet.

#### NOTES

File (F) Configuration is only available in widths 48" and 54".

Hinged door includes Push Latch, no handle option is available.

If Filing Accessory for box drawer is specified, the dividers match the color of the upStage handle, while the liner defaults to Ebony.

Orientation is determined from user's point of view, sitting at the desk.

#### PRODUCT OPTIONS

Width	Configuration	Pull Style	Orientation
48, 54, 60	<b>F</b> Navigate File <b>H</b> Navigate Hinged Door <b>B</b> Navigate Box/Box <b>E</b> hiSpace File <b>G</b> hiSpace Hinged Door <b>A</b> hiSpace Box, Box	<b>X</b> upStage Handle	<b>L</b> Left <b>R</b> Right

#### SAMPLE ORDER CODE

<b>HTSCC 48</b>	<b>F</b>	<b>X</b>	<b>R</b>
-----------------	----------	----------	----------

#### PRODUCT OPTIONS (CONTINUED)

Pull Finish	Leg Grommet Finish	Case, Shelves, Front & Back Finish	Key	Filing Accessory
Foundation	Foundation	Source Laminate	<b>N</b> No Key	<b>Y</b> Yes
Mica	Mica	Flintwood	<b>K</b> Key Alike	<b>N</b> No
Accent	Accent	Veneer	<b>R</b> Key Random	

#### SAMPLE ORDER CODE (CONTINUED)

<b>74</b>	<b>74</b>	<b>ZA</b>	<b>ZA</b>	<b>ZA</b>	<b>K</b>	<b>N</b>
-----------	-----------	-----------	-----------	-----------	----------	----------

See Pricing on the following page.



**HTSCC**  
**Double Credenza for**  
**Height-Adjustable Table**  
**(Continued)**

**DIMENSIONS**  
**INCHES / MM**

**PRICING**

		<b>FILE (F)</b>			
		<b>SOURCE LAMINATE</b>		<b>FLINTWOOD</b>	<b>VENEER</b>
W		Case, Shelves, Front & Back	Case, Shelves & Flintwood Front & Back	Case, Shelves, Front & Back	Case, Shelves, Front & Back
		48 / 1219		2064	2726
54 / 1372		2130	2807	4080	4275
		<b>HINGED DOOR (H)</b>			
		<b>SOURCE LAMINATE</b>		<b>FLINTWOOD</b>	<b>VENEER</b>
		Case, Shelves, Front & Back	Case, Shelves & Flintwood Front & Back	Case, Shelves, Front & Back	Case, Shelves, Front & Back
		48 / 1219		1717	2315
54 / 1372		1768	2386	3790	4005
60 / 1524		1835	2458	3904	4125
		<b>BOX, BOX (B)</b>			
		<b>SOURCE LAMINATE</b>		<b>FLINTWOOD</b>	<b>VENEER</b>
		Case, Shelves, Front & Back	Case, Shelves & Flintwood Front & Back	Case, Shelves, Front & Back	Case, Shelves, Front & Back
		48 / 1219		2219	2793
54 / 1372		2285	2876	4282	4493
60 / 1524		2371	2960	4410	4630

If Filing Accessory is specified, add 143

# height-adjustability

## HTSCT

### Triple Credenza for Height-Adjustable Table

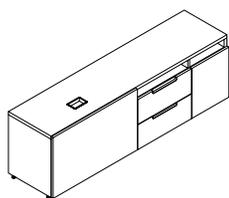

Right, Box, Box/  
Hinged Door

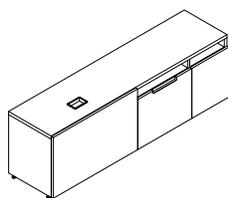

Right, File/Hinged  
Door

#### WHAT'S INCLUDED

Case and drawers/door, filing accessory (if box drawers are specified), hanging bar (when files drawer specified), leg grommet.

#### NOTES

Hinged door includes Push Latch, no handle option is available.

If Filing Accessory for box drawer is specified, the dividers match the color of the upStage handle, while the liner defaults to Ebony.

Orientation is determined from user's point of view, sitting at the desk.

Hinged Door is always positioned at the outer end of the credenza with drawers been placed in the mid section.

#### PRODUCT OPTIONS

Width	Configuration	Pull Style	Orientation
66, 72	<b>FH</b> Navigate File/Hinged Door <b>BH</b> Navigate Box, Box/Hinged Door <b>EH</b> hiSpace File/Hinged Door <b>AH</b> hiSpace Box, Box/Hinged Door	<b>X</b> upStage Handle	<b>L</b> Left <b>R</b> Right

#### SAMPLE ORDER CODE

<b>HTSCT 66</b>	<b>BH</b>	<b>X</b>	<b>R</b>
-----------------	-----------	----------	----------

#### PRODUCT OPTIONS (CONTINUED)

Pull Finish	Leg Grommet Finish	Case, Shelves, Front & Back Finish	Key	Filing Accessory
Foundation	Foundation	Source Laminate	<b>N</b> No Key	<b>Y</b> Yes
Mica	Mica	Flintwood	<b>K</b> Key Alike	<b>N</b> No
Accent	Accent	Veneer	<b>R</b> Key Random	

#### SAMPLE ORDER CODE (CONTINUED)

<b>74</b>	<b>74</b>	<b>ZA</b>	<b>ZA</b>	<b>ZA</b>	<b>K</b>	<b>N</b>
-----------	-----------	-----------	-----------	-----------	----------	----------

See Pricing on the following page.

**HTSCT**  
**Triple Credenza for**  
**Height-Adjustable Table**  
**(Continued)**

**DIMENSIONS**  
**INCHES / MM**

**PRICING**

	<b>FILE/HINGED DOOR (FH)</b>			
	<b>SOURCE LAMINATE</b>	<b>FLINTWOOD</b>	<b>VENEER</b>	
<b>W</b>	Case, Shelves, Front & Back	Case, Shelves & Flintwood Front & Back	Case, Shelves, Front & Back	Case, Shelves, Front & Back
66 / 1676	2495	3287	5346	5614
72 / 1829	2508	3307	5377	5645

	<b>BOX, BOX/HINGED DOOR (BH)</b>			
	<b>SOURCE LAMINATE</b>	<b>FLINTWOOD</b>	<b>VENEER</b>	
	Case, Shelves, Front & Back	Case, Shelves & Flintwood Front & Back	Case, Shelves, Front & Back	Case, Shelves, Front & Back
66 / 1676	2737	3607	5867	6159
72 / 1829	2756	3636	5911	6207

If Filing Accessory is specified, add 108

# height-adjustability

## HTSCD

### Height-Adjustable Integrated Double Credenza

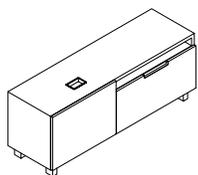

Right, File

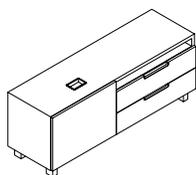

Right, Box, Box

#### WHAT'S INCLUDED

1 credenza with feet and levelers

1 leg pass-through grommet

Configuration B (Box/Box): two box drawers

Configuration F (File): one file drawer, one 12" hanging file bar (if width 48" is specified) and two 12" hanging file bars (if width 54"

If specified), lock and keys (if specified).

#### NOTES

Orientation is determined from user's perspective.

#### PRODUCT OPTIONS

Width	Configuration	Pull Style	Orientation
48, 54	<b>F</b> File <b>B</b> Box, Box	<b>X</b> upStage Handle	<b>L</b> Left <b>R</b> Right

#### SAMPLE ORDER CODE

<b>HTSCD 48</b>	<b>F</b>	<b>X</b>	<b>L</b>
-----------------	----------	----------	----------

#### PRODUCT OPTIONS (CONTINUED)

Pull Finish	Leg Grommet Finish	Case, Shelves, Front & Back Finish	Foot Finish	Key
Foundation	Foundation	Source Laminate	<b>74</b> Storm White	<b>N</b> No Key
Mica	Mica	Flintwood	<b>60</b> Platinum	<b>K</b> Key Alike
Accent	Accent	Veneer	<b>83</b> Very White	<b>R</b> Key Random
			<b>68</b> Anthracite	
			<b>62</b> Graphite	
			<b>71</b> Burnished Bronze	

#### SAMPLE ORDER CODE (CONTINUED)

<b>74</b>	<b>74</b>	<b>ZA</b>	<b>ZA</b>	<b>ZA</b>	<b>60</b>	<b>K</b>
-----------	-----------	-----------	-----------	-----------	-----------	----------

See Pricing on the following page.

**H T S C D**  
**Height-Adjustable**  
**Integrated Double Credenza**  
**(Continued)**

**DIMENSIONS**  
**INCHES / MM**

**PRICING**

		<b>FILE (F)</b>			
		<b>SOURCE LAMINATE</b>		<b>FLINTWOOD</b>	<b>VENEER</b>
		Case, Shelves, Front & Back	Case, Shelves & Flintwood Front & Back	Case, Shelves, Front & Back	Case, Shelves, Front & Back
<b>W</b>					
48 / 1219		2245	2539	4600	4829
54 / 1372		2312	2612	4762	5002

  

		<b>BOX, BOX (B)</b>			
		<b>SOURCE LAMINATE</b>		<b>FLINTWOOD</b>	<b>VENEER</b>
		Case, Shelves, Front & Back	Case, Shelves & Flintwood Front & Back	Case, Shelves, Front & Back	Case, Shelves, Front & Back
48 / 1219		2120	2394	4302	4519
54 / 1372		2183	2468	4472	4697

# height-adjustability

## HTSCP

### Height-Adjustable Integrated Triple Credenza

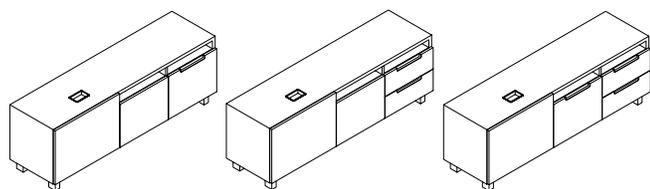

Right, Hinged  
Door/File

Right, Hinged  
Door/Box, Box

Left, Hinged File/  
Box, Box

#### WHAT'S INCLUDED

1 credenza with feet and levelers

1 leg pass-through grommet

Configuration FB (File/Box) : two box drawers and 1 file drawer, one 12" hanging bar

Configuration HB (Hinged door/Box): two box drawers and one hinged door

Configuration HF(Hinged door/File): one file drawer, one hinged door and one 12" hanging bar; lock and keys (if specified).

#### NOTES

Orientation is determined from user's perspective.

Configuration (FB) is only available if WIDTH 60-72 is specified.

Hinged Door includes a push latch, no handle option.

Hinged Door is always positioned in the middle. Box, Box is always at the outer end.

#### PRODUCT OPTIONS

Width	Configuration	Pull Style	Orientation
54, 60, 66, 72	<b>HF</b> Hinged Door/File <b>HB</b> Hinged Door/Box, Box <b>FB</b> File/Box, Box	<b>X</b> upStage Handle	<b>L</b> Left <b>R</b> Right

#### SAMPLE ORDER CODE

<b>HTSCP 60</b>	<b>FH</b>	<b>X</b>	<b>R</b>
-----------------	-----------	----------	----------

#### PRODUCT OPTIONS (CONTINUED)

Pull Finish	Leg Grommet Finish	Case, Shelves, Front & Back Finish	Foot Finish	Key
Foundation	Foundation	Source Laminate	<b>74</b> Storm White	<b>N</b> No Key
Mica	Mica	Flintwood	<b>60</b> Platinum	<b>K</b> Key Alike
Accent	Accent	Veneer	<b>83</b> Very White	<b>R</b> Key Random
			<b>68</b> Anthracite	
			<b>62</b> Graphite	
			<b>71</b> Burnished Bronze	

#### SAMPLE ORDER CODE (CONTINUED)

<b>74</b>	<b>74</b>	<b>ZA</b>	<b>ZA</b>	<b>ZA</b>	<b>60</b>	<b>K</b>
-----------	-----------	-----------	-----------	-----------	-----------	----------

See Pricing on the following page.

**HTSCP**  
**Height-Adjustable**  
**Integrated Triple Credenza**  
**(Continued)**

**DIMENSIONS**  
**INCHES / MM**

**PRICING**

W	HINGED DOOR/FILE (HF)			
	SOURCE LAMINATE		FLINTWOOD	VENEER
	Case, Shelves, Front & Back	Case, Shelves & Flintwood Front & Back	Case, Shelves, Front & Back	Case, Shelves, Front & Back
54 / 1372	2352	2649	5042	5298
60 / 1524	2444	2734	5196	5455
66 / 1676	2500	2820	5348	5615
72 / 1829	2579	2903	5496	5771

W	HINGED DOOR/BOX, BOX (HB)			
	SOURCE LAMINATE		FLINTWOOD	VENEER
	Case, Shelves, Front & Back	Case, Shelves & Flintwood Front & Back	Case, Shelves, Front & Back	Case, Shelves, Front & Back
54 / 1372	2614	2988	5298	5566
60 / 1524	2699	3079	5454	5726
66 / 1676	2770	3169	5607	5889
72 / 1829	2860	3270	5757	6046

W	FILE/BOX, BOX (FB)			
	SOURCE LAMINATE		FLINTWOOD	VENEER
	Case, Shelves, Front & Back	Case, Shelves & Flintwood Front & Back	Case, Shelves, Front & Back	Case, Shelves, Front & Back
60 / 1524	2925	3233	5726	6013
66 / 1676	3013	3328	5889	6184
72 / 1829	3101	3435	6046	6349

casual screens



# product map

## HTNX Casual Glass Screen

Page 334

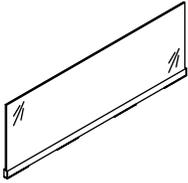

## HTND Casual Solid Screen

Page 335



With Accessory Rail

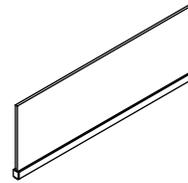

Without Accessory Rail

## HTNJ Casual Thick Solid Screen

Page 336

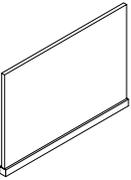

## HTNK Casual Thick Solid Screen with Glass

Page 338

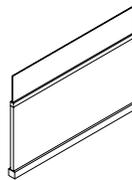

## GXAU Casual Infinity Screen

Page 340

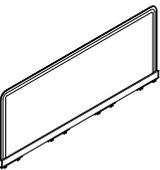

## HTNB Casual Framed Fabric Screen

Page 342

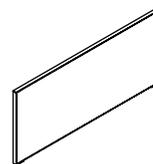

## HTNG Glass Desk Edge Screen

Page 343

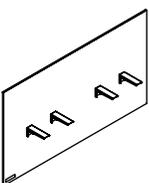

## HTNS Solid Desk Edge Screen

Page 344

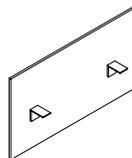

Modesty Height, shown Without Accessory Rail

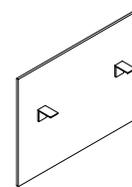

Elevated Height, shown Without Accessory Rail

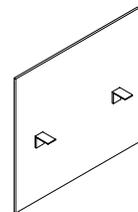

Floor Height, shown Without Accessory Rail

## product map

**G X C U** Infinity Curved Desk Edge Screen

Page 348

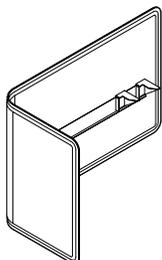

**G X D U** Infinity Desk Edge Screen

Page 352

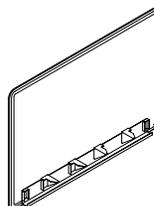

---

**G Q D U** Quilted Infinity Desk Edge Screen

Page 366

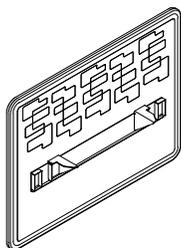

**G X S U** Infinity Side Desk Edge Screen

Page 368

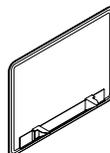

---

**H T N F** Framed Fabric Desk Edge Screen

Page 372

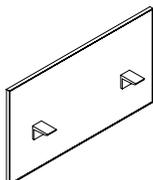

**G Y S U** Framed Fabric Side Desk Edge Screen

Page 376

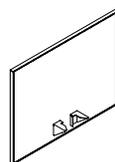

---

**G X F U** Infinity Desk Edge Floor Screen

Page 380

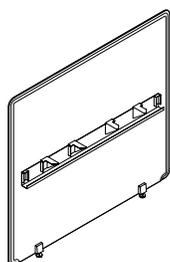

**G X E U** Infinity Side Desk Edge Floor Screen

Page 382

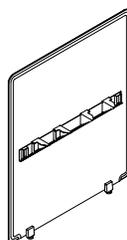

# product map

## G X C C Infinity Screen Alignment Clip

Page 383



## G Y F U Framed Fabric Desk Edge Floor Screen

Page 384

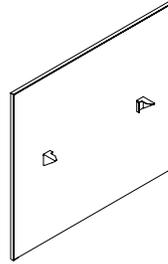

## G Y E U Framed Fabric Side Desk Edge Floor Screen

Page 386

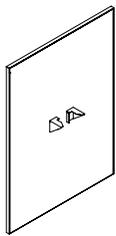

## G V G U Desk Edge Screen with Glass

Page 388

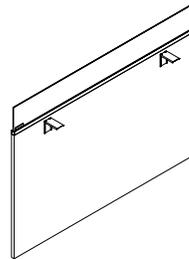

## H T N N Modesty Screen

Page 390

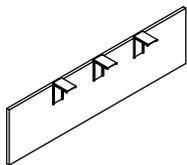

## H T N L Solid Lateral Floor Screen

Page 392

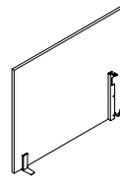

End Mounted Single, left handedness shown

## H T N A Solid Lateral Screen with Glass

Page 396

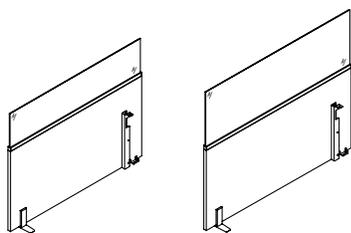

End Mounted Single, 43" Total, left handedness shown

End Mounted Single, 53" Total, left handedness shown

## H T N C Solid Corridor Screen

Page 401

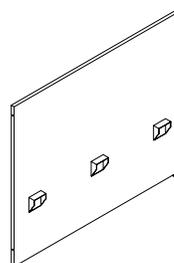

## product map

**H T N E** Solid Corridor Screen with Glass

Page 402

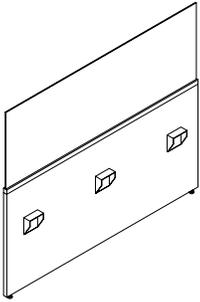

**G N G U** Glass 6mm Lateral Screen

Page 404

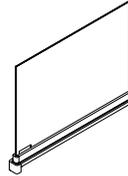

**G N T U** Glass 10mm Lateral Screen

Page 405

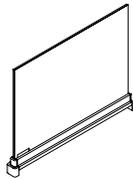

**G N W U** Writeable Glass Lateral Screen

Page 406

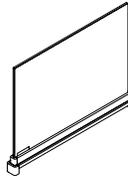

**G N S U** Solid Lateral Screen

Page 407

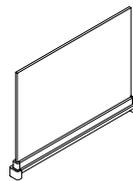

**G N L U** Writeable Laminate Lateral Screen

Page 408

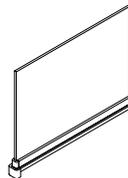

**G N X U** Infinity Lateral Screen

Page 409

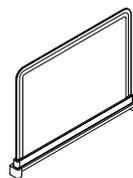

**G N Z U** Smooth Felt Lateral Screen

Page 410

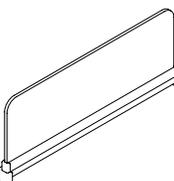

# product map

## G N M U Metal Lateral Screen

Page 412

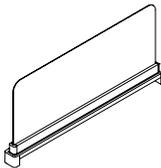

## G N Y U Framed Fabric Lateral Screen

Page 411

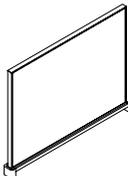



The Solid Casual Screen provides casual privacy and space division.

**HTND**

**Casual Solid Screen**

**WHAT'S INCLUDED**

1 solid screen, continuous metal attachment bracket, alignment clips and accessory rail (if specified).

**NOTES**

Accessory Rail can accommodate selected Personal Organizers (PAX) and fx accessories, available from Complements: *Teknion's Ergonomic & Accessories Program*.

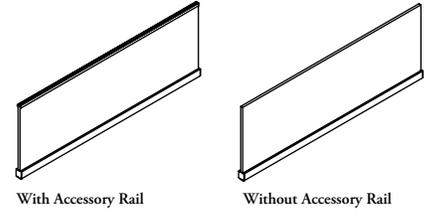

**PRODUCT OPTIONS**

Accessory Rail	Height	Width	Screen Finish	Metal Frame Finish
A With Accessory Rail	21 for 42" high datum	24, 30, 36, 42, 48, 54, 60, 66, 72, 78, 84, 90, 96	Source Laminate Flintwood Natural Veneer	Foundation Mica Accent
N Without Accessory Rail	30 for 51" high datum			

**SAMPLE ORDER CODE**

<b>HTND A</b>	<b>21</b>	<b>48</b>	<b>ZI</b>	<b>74</b>
---------------	-----------	-----------	-----------	-----------

**DIMENSIONS  
INCHES / MM**

H	W
42 / 1067	24 / 610
42 / 1067	30 / 762
42 / 1067	36 / 762
42 / 1067	42 / 1067
42 / 1067	48 / 1219
42 / 1067	54 / 1372
42 / 1067	60 / 1524
42 / 1067	66 / 1676
42 / 1067	72 / 1829
42 / 1067	78 / 1981
42 / 1067	84 / 2134
42 / 1067	90 / 2286
42 / 1067	96 / 2438
51 / 1295	24 / 610
51 / 1295	30 / 762
51 / 1295	36 / 762
51 / 1295	42 / 1067
51 / 1295	48 / 1219
51 / 1295	54 / 1372
51 / 1295	60 / 1524
51 / 1295	66 / 1676
51 / 1295	72 / 1829
51 / 1295	78 / 1981
51 / 1295	84 / 2134
51 / 1295	90 / 2286
51 / 1295	96 / 2438

**PRICING**

WITHOUT ACCESSORY RAIL (N)			WITH ACCESSORY RAIL (A)		
Source Laminate	Flintwood	Natural Veneer	Source Laminate	Flintwood	Natural Veneer
395	623	685	436	698	767
430	707	776	484	792	869
461	785	863	517	881	967
497	871	958	565	977	1072
605	952	1049	672	1069	1175
623	1038	1143	702	1161	1279
657	1120	1232	738	1253	1379
685	1203	1324	777	1348	1483
730	1286	1415	822	1440	1583
771	1366	1504	864	1530	1685
800	1453	1598	891	1628	1791
836	1531	1687	936	1715	1888
871	1620	1783	973	1814	1996
435	794	883	488	889	978
474	899	1000	529	1008	1108
507	1002	1112	569	1121	1233
548	1110	1234	611	1244	1368
666	1218	1353	746	1361	1497
685	1324	1469	767	1483	1629
725	1427	1588	810	1600	1758
755	1536	1704	845	1719	1889
803	1641	1823	899	1837	2021
851	1742	1937	951	1951	2148
882	1854	2059	986	2076	2284
920	1956	2173	1030	2189	2407
958	2063	2296	1072	2312	2545

If Accent/Mica is specified, add 14

## HTNJ

### Casual Thick Solid Screen

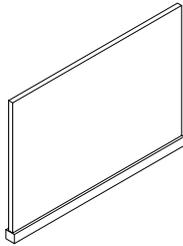

The Thick Solid Casual Screen provides casual privacy and space division at different heights.

#### WHAT'S INCLUDED

1 solid screen, continuous metal attachment bracket, alignment clips and accessory rail (if specified).

#### NOTES

Accessory Rail can accommodate selected Personal Organizers (PAX) and fx accessories, available from Complements: *Teknion's Ergonomics & Accessories Program*.

The Without Accessory Rail option can support the Sit and Slide Screen with Accessories (JNSSE).

#### PRODUCT OPTIONS

Accessory Rail	Height	Width (in 6" increments)	Alignment	Screen Finish	Metal Frame Finish
<b>A</b> With Accessory Rail	<b>21</b> for 42" high datum	24, 30, 36, 42, 48, 54, 60, 66, 72, 78, 84, 90, 96	<b>N</b> No Alignment	Source Laminate	Foundation
<b>N</b> Without Accessory Rail	<b>30</b> for 51" high datum		<b>W</b> With In Line Alignment	Flintwood	Mica
	<b>36</b> for 57" high datum		<b>E</b> End Alignment	Natural Veneer	Accent

#### SAMPLE ORDER CODE

<b>HTNJ A</b>	<b>21</b>	<b>48</b>	<b>N</b>	<b>ZI</b>	<b>74</b>
---------------	-----------	-----------	----------	-----------	-----------

#### DIMENSIONS INCHES / MM

H	W
42 / 1067	24 / 610
42 / 1067	30 / 762
42 / 1067	36 / 762
42 / 1067	42 / 1067
42 / 1067	48 / 1219
42 / 1067	54 / 1372
42 / 1067	60 / 1524
42 / 1067	66 / 1676
42 / 1067	72 / 1829
42 / 1067	78 / 1981
42 / 1067	84 / 2134
42 / 1067	90 / 2286
42 / 1067	96 / 2438
51 / 1295	24 / 610
51 / 1295	30 / 762
51 / 1295	36 / 762
51 / 1295	42 / 1067
51 / 1295	48 / 1219
51 / 1295	54 / 1372
51 / 1295	60 / 1524
51 / 1295	66 / 1676
51 / 1295	72 / 1829
51 / 1295	78 / 1981
51 / 1295	84 / 2134
51 / 1295	90 / 2286
51 / 1295	96 / 2438

#### PRICING

##### WITHOUT ACCESSORY RAIL (N)

Source Laminate	Flintwood	Natural Veneer
474	746	822
518	849	932
553	942	1038
597	1045	1150
726	1144	1259
746	1244	1369
790	1342	1477
822	1444	1590
875	1543	1697
927	1642	1806
961	1746	1918
1004	1840	2025
1045	1944	2138
522	952	1058
571	1080	1200
609	1202	1334
656	1333	1480
798	1461	1621
822	1590	1763
868	1712	1904
906	1841	2044
963	1967	2186
1021	2093	2326
1057	2223	2471
1104	2345	2606
1150	2474	2752

##### WITH ACCESSORY RAIL (A)

Source Laminate	Flintwood	Natural Veneer
525	836	920
581	950	1044
619	1055	1161
677	1172	1287
806	1282	1410
843	1393	1531
886	1504	1654
934	1619	1780
986	1728	1903
1039	1837	2024
1071	1953	2149
1124	2059	2266
1166	2178	2395
585	1068	1174
638	1210	1332
681	1343	1478
734	1494	1643
897	1633	1797
920	1780	1956
973	1920	2112
1014	2061	2267
1080	2206	2424
1143	2343	2577
1183	2492	2742
1235	2627	2887
1287	2774	3052

Pricing is continued on the following page.

If Accent/Mica is specified, add 14



**HTNJ**  
**Casual Thick Solid Screen**  
**(Continued)**

**DIMENSIONS**  
**INCHES / MM**

H	W
57 / 1448	24 / 610
57 / 1448	30 / 762
57 / 1448	36 / 762
57 / 1448	42 / 1067
57 / 1448	48 / 1219
57 / 1448	54 / 1372
57 / 1448	60 / 1524
57 / 1448	66 / 1676
57 / 1448	72 / 1829
57 / 1448	78 / 1981
57 / 1448	84 / 2134
57 / 1448	90 / 2286
57 / 1448	96 / 2438

**PRICING**

WITHOUT ACCESSORY RAIL (N)			WITH ACCESSORY RAIL (A)		
Source Laminate	Flintwood	Natural Veneer	Source Laminate	Flintwood	Natural Veneer
575	1214	1349	643	1359	1498
628	1378	1530	701	1542	1697
670	1534	1702	748	1712	1886
722	1700	1888	806	1904	2094
879	1863	2067	987	2082	2291
904	2026	2247	1011	2269	2493
955	2183	2427	1069	2449	2694
996	2348	2607	1115	2628	2890
1061	2509	2789	1190	2812	3090
1124	2668	2965	1257	2988	3285
1163	2835	3149	1303	3177	3495
1214	2990	3323	1359	3348	3682
1264	3155	3511	1415	3538	3890

If Accent/Mica is specified, add 14

## HTNK

### Casual Thick Solid Screen with Glass

The Thick Solid Casual Screen with Glass provides casual privacy and space division.

#### WHAT'S INCLUDED

1 solid screen with glass top, continuous metal attachment bracket, alignment clips.

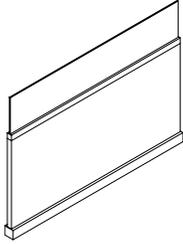

#### PRODUCT OPTIONS

Height	Width (in 6" increments)	Alignment	Screen Finish	Glass Finish	Metal Frame Finish
<b>B</b> 51" total (42" plus 9" glass)	24, 30, 36, 42, 48, 54, 60, 66, 72, 78, 84, 90, 96	<b>N</b> No Alignment	Source Laminate	<b>CL</b> Clear	Foundation
<b>C</b> 57" total (48" plus 9" glass)		<b>W</b> With In Line Alignment	Flintwood	<b>FT</b> Frost	Mica
		<b>E</b> End Alignment	Natural Veneer		Accent

#### SAMPLE ORDER CODE

<b>HTNK B</b>	<b>48</b>	<b>N</b>	<b>AG</b>	<b>CL</b>	<b>74</b>
---------------	-----------	----------	-----------	-----------	-----------

#### DIMENSIONS INCHES / MM

H	W
51 / 1295	24 / 610
51 / 1295	30 / 762
51 / 1295	36 / 762
51 / 1295	42 / 1067
51 / 1295	48 / 1219
51 / 1295	54 / 1372
51 / 1295	60 / 1524
51 / 1295	66 / 1676
51 / 1295	72 / 1829
51 / 1295	78 / 1981
51 / 1295	84 / 2134
51 / 1295	90 / 2286
51 / 1295	96 / 2438
57 / 1448	24 / 610
57 / 1448	30 / 762
57 / 1448	36 / 762
57 / 1448	42 / 1067
57 / 1448	48 / 1219
57 / 1448	54 / 1372
57 / 1448	60 / 1524
57 / 1448	66 / 1676
57 / 1448	72 / 1829
57 / 1448	78 / 1981
57 / 1448	84 / 2134
57 / 1448	90 / 2286
57 / 1448	96 / 2438

#### PRICING

SOURCE LAMINATE		FLINTWOOD		NATURAL VENEER	
Clear	Frost	Clear	Frost	Clear	Frost
694	763	1094	1124	1151	1250
762	841	1225	1259	1295	1402
817	907	1347	1391	1433	1549
883	985	1478	1530	1579	1704
950	1065	1483	1539	1622	1712
1150	1273	1858	1911	1951	2131
1168	1304	1922	1982	2043	2210
1236	1380	2071	2131	2199	2378
1313	1468	2217	2287	2359	2552
1354	1520	2303	2377	2469	2659
1387	1567	2420	2501	2602	2795
1439	1619	2524	2607	2719	2912
1483	1660	2643	2726	2849	3041
734	783	1174	1181	1232	1306
810	867	1316	1324	1386	1466
875	940	1456	1466	1542	1622
947	1019	1598	1614	1697	1787
1037	1118	1644	1658	1783	1832
1230	1316	2013	2021	2107	2240
1303	1400	2167	2177	2288	2404
1325	1444	2077	2180	2206	2427
1342	1506	2269	2290	2409	2556
1391	1531	2401	2412	2566	2695
1453	1579	2562	2582	2744	2876
1530	1637	2714	2722	2909	3028
1600	1680	2880	2880	3086	3195

If Accent/Mica is specified, add 14



## G X A U Casual Infinity Screen

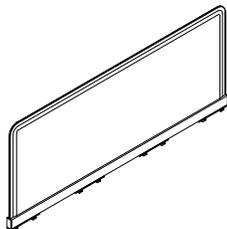

The Casual Infinity Screen attaches to the Accessory Beam to provide a lightweight, thin, upholstered fabric screen that is expressed in a softer curvilinear aesthetic that creates space division and local desktop privacy in varying levels.

### WHAT'S INCLUDED

1 infinity fabric desk edge screen, attachment brackets.

### NOTES

Fabric will be applied in the railroad direction in select Panel and Upholstery fabrics, refer to the *Teknion Textiles Program Guide*.

Stage (S) application is not available on 30" height.

### PRODUCT OPTIONS

Height	Width (in 6" increments)	Application	Screen Finish	Hardware Finish
42 for 42" high datum 51 for 51" high datum	24, 30, 36, 42, 48, 54, 60, 66, 72	<b>S</b> Stage <b>W</b> Worksurface	Panel Fabrics Upholstery Fabrics	Foundation Mica Accent

### SAMPLE ORDER CODE

<b>GXAU 21</b>	<b>60</b>	<b>S</b>	<b>B204</b>	<b>74</b>
----------------	-----------	----------	-------------	-----------

### DIMENSIONS INCHES / MM

H	W
42 / 1067	24 / 610
42 / 1067	30 / 762
42 / 1067	36 / 762
42 / 1067	42 / 1067
42 / 1067	48 / 1219
42 / 1067	54 / 1372
42 / 1067	60 / 1524
42 / 1067	66 / 1676
42 / 1067	72 / 1829

### PRICING

#### STAGE MOUNT (S)

#### PANEL FABRIC

COM/ Gr. A	Gr. 1	Gr. 2	Gr. 3	Gr. 4	Gr. 5
558	567	579	615	641	668
600	608	619	666	699	730
639	648	665	717	756	792
694	705	724	785	828	869
745	761	781	850	898	947
844	859	882	959	1014	1068
872	889	914	1000	1060	1120
906	924	950	1044	1110	1175
935	954	984	1084	1157	1227

#### UPHOLSTERY FABRIC

COM/ Gr. 1	Gr. 2	Gr. 3	Gr. 4	Gr. 5	Gr. 6	Gr. 7	Gr. 8	Gr. 9	Gr. 10
560	593	606	624	654	670	686	722	756	769
603	639	655	677	711	732	753	794	836	854
641	685	703	731	770	796	820	869	918	941
698	746	768	800	846	874	901	958	1015	1040
752	807	831	867	920	950	981	1045	1110	1137
850	913	941	979	1038	1071	1105	1177	1251	1281
879	948	978	1021	1085	1125	1162	1242	1320	1355
912	988	1021	1069	1138	1181	1223	1310	1395	1433
941	1023	1060	1110	1188	1233	1279	1373	1467	1507

If Accent/Mica Hardware Finish is specified for width 24" - 42", add 14

If Accent/Mica Hardware Finish is specified for width 48" - 72", add 29

Pricing is continued on the following page.

**G X A U**  
**Casual Infinity Screen**  
**(Continued)**

**DIMENSIONS**  
**INCHES / MM**

H	W
42 / 1067	24 / 610
42 / 1067	30 / 762
42 / 1067	36 / 762
42 / 1067	42 / 1067
42 / 1067	48 / 1219
42 / 1067	54 / 1372
42 / 1067	60 / 1524
42 / 1067	66 / 1676
42 / 1067	72 / 1829
51 / 1295	24 / 610
51 / 1295	30 / 762
51 / 1295	36 / 762
51 / 1295	42 / 1067
51 / 1295	48 / 1219
51 / 1295	54 / 1372
51 / 1295	60 / 1524
51 / 1295	66 / 1676
51 / 1295	72 / 1829

**PRICING**

WORKSURFACE MOUNT (W)															
PANEL FABRIC						UPHOLSTERY FABRIC									
COM/ Gr. A	Gr. 1	Gr. 2	Gr. 3	Gr. 4	Gr. 5	COM/ Gr. 1	Gr. 2	Gr. 3	Gr. 4	Gr. 5	Gr. 6	Gr. 7	Gr. 8	Gr. 9	Gr. 10
560	567	575	602	617	635	564	583	593	606	624	636	646	670	692	702
603	608	615	646	668	690	604	630	639	655	677	691	703	732	761	770
641	648	660	696	718	743	645	673	686	703	731	746	763	796	829	844
699	705	716	760	789	815	700	734	748	768	798	819	836	874	912	928
752	761	771	821	853	884	755	792	807	831	867	887	910	950	993	1012
850	859	874	925	962	997	853	895	913	940	978	1002	1023	1072	1121	1142
879	889	906	963	1004	1042	883	928	949	978	1021	1046	1071	1125	1176	1200
912	924	942	1005	1048	1092	916	967	989	1021	1068	1097	1124	1181	1237	1263
942	954	974	1041	1090	1136	947	1002	1024	1058	1110	1142	1172	1233	1296	1323
670	676	687	726	752	777	672	702	715	734	763	778	796	830	864	881
729	737	751	796	828	859	731	768	785	807	843	861	883	924	966	984
789	797	814	867	904	941	791	833	853	881	920	944	967	1018	1068	1090
854	864	883	944	988	1030	857	907	928	961	1007	1034	1061	1118	1175	1200
924	940	959	1028	1076	1125	929	986	1011	1045	1099	1129	1161	1225	1288	1316
1042	1058	1080	1158	1213	1266	1048	1112	1138	1177	1235	1269	1305	1378	1448	1478
1084	1101	1127	1211	1273	1332	1091	1160	1190	1233	1298	1336	1374	1453	1531	1567
1135	1153	1180	1274	1340	1406	1142	1218	1251	1298	1368	1410	1451	1539	1626	1660
1180	1200	1228	1329	1402	1471	1185	1268	1305	1356	1433	1477	1522	1619	1711	1753

If Accent/Mica Hardware Finish is specified for width 24" - 42", add 14  
If Accent/Mica Hardware Finish is specified for width 48" - 72", add 29

## HTNB

### Casual Framed Fabric Screen

The Casual Fabric Screen attaches to the Accessory Beam to provide space division.

#### WHAT'S INCLUDED

1 fabric screen, sliding metal attachment bracket and clips.

#### NOTES

Fabric will be applied in the railroad direction in select Panel and Upholstery fabrics, refer to the *Teknion Textiles Program Guide*.

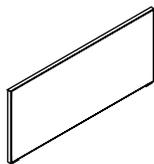

#### PRODUCT OPTIONS

Height	Width (in 6" increments)	Application	Screen Finish	Metal Frame Finish
<b>13</b> for 42" high datum worksurface mount	24, 30, 36, 42, 48, 54, 60, 66, 72	<b>S</b> Stage Mount <b>W</b> Worksurface Mount	Panel Fabric Upholstery Fabrics	Foundation
<b>21</b> for 42" high datum stage mount				Mica
<b>22</b> for 51" high datum worksurface mount				Accent

#### SAMPLE ORDER CODE

<b>HTNB 21</b>	<b>48</b>	<b>S</b>	<b>L308</b>	<b>74</b>
----------------	-----------	----------	-------------	-----------

#### DIMENSIONS INCHES / MM

H	W
42 / 1067	24 / 610
42 / 1067	30 / 762
42 / 1067	36 / 762
42 / 1067	42 / 1067
42 / 1067	48 / 1219
42 / 1067	54 / 1372
42 / 1067	60 / 1524
42 / 1067	66 / 1676
42 / 1067	72 / 1829
51 / 1295	24 / 610
51 / 1295	30 / 762
51 / 1295	36 / 762
51 / 1295	42 / 1067
51 / 1295	48 / 1219
51 / 1295	54 / 1372
51 / 1295	60 / 1524
51 / 1295	66 / 1676
51 / 1295	72 / 1829

#### PRICING

##### PANEL FABRIC

COM/ Gr. A	Gr. 1	Gr. 2	Gr. 3	Gr. 4	Gr. 5
534	541	548	574	588	608
574	579	586	617	639	661
611	618	630	665	690	713
665	672	684	726	755	782
715	725	737	785	817	849
808	820	833	886	921	958
836	849	863	921	962	1002
867	881	897	961	1004	1046
895	910	927	995	1042	1091
638	645	656	694	718	745
694	702	715	762	793	824
751	761	776	829	867	902
812	823	841	902	947	988
881	894	914	984	1033	1080
992	1008	1030	1107	1162	1215
1033	1049	1074	1160	1221	1280
1080	1099	1125	1219	1285	1349
1122	1143	1172	1273	1343	1415

##### UPHOLSTERY FABRIC

COM/ Gr. 1	Gr. 2	Gr. 3	Gr. 4	Gr. 5	Gr. 6	Gr. 7	Gr. 8	Gr. 9	Gr. 10
536	556	565	579	597	609	618	641	665	675
575	602	610	625	648	663	675	703	731	741
613	643	656	673	701	716	732	766	798	814
666	701	715	736	766	785	803	841	879	895
717	756	770	796	830	851	872	914	958	977
812	856	872	898	937	961	984	1033	1080	1100
841	887	907	936	979	1005	1030	1083	1135	1158
871	922	944	977	1022	1051	1078	1136	1195	1219
899	954	979	1012	1065	1095	1125	1188	1251	1276
640	671	684	702	731	746	764	798	833	849
698	734	751	771	807	828	849	889	932	949
753	796	815	843	883	907	929	980	1030	1051
815	864	887	918	965	992	1019	1075	1133	1158
886	942	966	1002	1054	1084	1116	1180	1244	1273
997	1061	1090	1128	1185	1221	1255	1327	1398	1430
1039	1107	1137	1181	1248	1285	1323	1402	1480	1514
1085	1162	1196	1243	1313	1356	1396	1485	1570	1605
1128	1211	1249	1298	1374	1419	1466	1561	1654	1695

If Accent/Mica Hardware Finish is specified for width 24" - 42", add 14

If Accent/Mica Hardware Finish is specified for width 48" - 72", add 29

The Glass Desk Edge Glass Screen attaches to the worksurface to provide space division and territorial desktop privacy

**HTNG**

**Glass Desk Edge Screen**

**WHAT'S INCLUDED**

1 glass desk edge screen, attachment brackets.

**NOTES**

Glass thickness is 6mm or 10mm.

Dimensions are actual width.

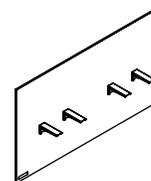

**PRODUCT OPTIONS**

Modesty Base Height	Height Above Worksurface	Width (in 6" increments)	Glass Thickness	Screen Finish	Frame Finish
M Modesty Height (15")	13 for 42" high datum 22 for 51" high datum 28 for 57" high datum	30, 36, 42, 48, 54, 60, 66	6 6mm 10 10mm	CL Clear FT Frost	Foundation Mica Accent

**SAMPLE ORDER CODE**

<b>HTNG M</b>	<b>22</b>	<b>66</b>	<b>6</b>	<b>FT</b>	<b>74</b>
---------------	-----------	-----------	----------	-----------	-----------

**DIMENSIONS  
INCHES / MM**

H	W
42 / 1067	30 / 762
42 / 1067	36 / 762
42 / 1067	42 / 1067
42 / 1067	48 / 1219
42 / 1067	54 / 1372
42 / 1067	60 / 1524
42 / 1067	66 / 1676
51 / 1295	30 / 762
51 / 1295	36 / 762
51 / 1295	42 / 1067
51 / 1295	48 / 1219
51 / 1295	54 / 1372
51 / 1295	60 / 1524
51 / 1295	66 / 1676
57 / 1448	30 / 762
57 / 1448	36 / 762
57 / 1448	42 / 1067
57 / 1448	48 / 1219
57 / 1448	54 / 1372
57 / 1448	60 / 1524
57 / 1448	66 / 1676

**PRICING**

6MM GLASS		10MM GLASS	
Clear	Frost	Clear	Frost
437	791	580	985
498	897	660	1118
559	1010	739	1256
630	1131	829	1410
700	1262	924	1570
771	1275	1019	1733
851	1406	1122	1908
460	949	609	1182
523	1075	691	1343
587	1207	776	1509
660	1358	869	1694
736	1387	971	1726
810	1528	1070	1906
894	1682	1181	2099
491	1016	631	1225
559	1158	738	1438
631	1303	850	1650
705	1467	985	1919
789	1508	1202	2137
874	1675	1338	2381
961	1843	1478	2627

If Accent/Mica is specified, add 25

## HTNS

### Solid Desk Edge Screen

The Solid Desk Edge Screen attaches to the worksurface to provide space division and territorial desktop privacy.

#### WHAT'S INCLUDED

1 desk edge screen, attachment brackets.

#### NOTES

Accessory Rail can accommodate selected Personal Organizers (PAX) and fx accessories, available from Complements: *Teknion's Ergonomic & Accessories Program*.

Actual width is nominal (specified) width.

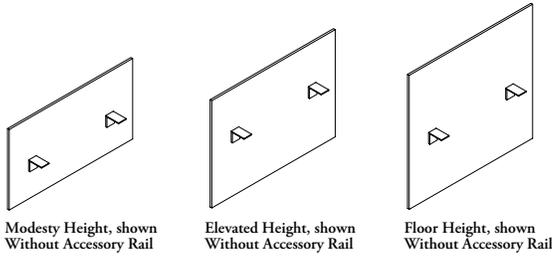

#### PRODUCT OPTIONS

Accessory Rail	Modesty Base Height	Height Above Worksurface	Width (in 6" increments)	Screen Finish	Metal Frame Finish
<b>A</b> With Accessory Rail	<b>S</b> Partial Modesty Height (23")	<b>0</b> for 29" high datum	24, 30, 36, 42, 48, 54, 60, 66	Source Laminate	Foundation
<b>N</b> Without Accessory Rail	<b>M</b> Modesty Height (15")	<b>13</b> for 42" high datum		Flintwood	Mica
	<b>E</b> Elevated Height (6")	<b>22</b> for 51" high datum		Natural Veneer	Accent
	<b>F</b> Floor Height (1")	<b>28</b> for 57" high datum			

#### SAMPLE ORDER CODE

<b>HTNS A</b>	<b>M</b>	<b>22</b>	<b>54</b>	<b>ZI</b>	<b>74</b>
---------------	----------	-----------	-----------	-----------	-----------

#### DIMENSIONS INCHES / MM

H	W
29 / 737	24 / 610
29 / 737	30 / 762
29 / 737	36 / 762
29 / 737	42 / 1067
29 / 737	48 / 1219
29 / 737	54 / 1372
29 / 737	60 / 1524
29 / 737	66 / 1676
29 / 737	72 / 1829
42 / 1067	24 / 610
42 / 1067	30 / 762
42 / 1067	36 / 762
42 / 1067	42 / 1067
42 / 1067	48 / 1219
42 / 1067	54 / 1372
42 / 1067	60 / 1524
42 / 1067	66 / 1676
42 / 1067	72 / 1829

#### PRICING

WITHOUT ACCESSORY RAIL (N)		
PARTIAL MODESTY HEIGHT (S)		
Source Laminate	Flintwood	Natural Veneer
174	296	312
183	311	332
191	330	347
205	344	368
213	362	387
223	376	420
235	394	452
244	411	483
255	427	517
249	504	506
272	544	556
298	597	608
321	655	656
344	701	708
369	753	781
393	803	834
419	854	899
438	904	910

WITH ACCESSORY RAIL (A)		
PARTIAL MODESTY HEIGHT (S)		
Source Laminate	Flintwood	Natural Veneer
n/a	n/a	n/a
n/a	n/a	n/a
n/a	n/a	n/a
n/a	n/a	n/a
n/a	n/a	n/a
n/a	n/a	n/a
n/a	n/a	n/a
n/a	n/a	n/a
n/a	n/a	n/a
278	588	707
307	636	777
334	699	849
364	769	922
392	824	993
420	886	1095
450	949	1174
476	1008	1266
504	1069	1281

If Accent/Mica is specified, add 25

Pricing is continued on the following page



**H T N S**

**Solid Desk Edge Screen (Continued)**

**DIMENSIONS  
INCHES / MM**

H	W
51 / 1295	24 / 610
51 / 1295	30 / 762
51 / 1295	36 / 762
51 / 1295	42 / 1067
51 / 1295	48 / 1219
51 / 1295	54 / 1372
51 / 1295	60 / 1524
51 / 1295	66 / 1676
51 / 1295	72 / 1829
57 / 1448	24 / 610
57 / 1448	30 / 762
57 / 1448	36 / 762
57 / 1448	42 / 1067
57 / 1448	48 / 1219
57 / 1448	54 / 1372
57 / 1448	60 / 1524
57 / 1448	66 / 1676
57 / 1448	72 / 1829
29 / 737	24 / 610
29 / 737	30 / 762
29 / 737	36 / 762
29 / 737	42 / 1067
29 / 737	48 / 1219
29 / 737	54 / 1372
29 / 737	60 / 1524
29 / 737	66 / 1676
42 / 1067	24 / 610
42 / 1067	30 / 762
42 / 1067	36 / 762
42 / 1067	42 / 1067
42 / 1067	48 / 1219
42 / 1067	54 / 1372
42 / 1067	60 / 1524
42 / 1067	66 / 1676
51 / 1295	24 / 610
51 / 1295	30 / 762
51 / 1295	36 / 762
51 / 1295	42 / 1067
51 / 1295	48 / 1219
51 / 1295	54 / 1372
51 / 1295	60 / 1524
51 / 1295	66 / 1676
57 / 1448	24 / 610
57 / 1448	30 / 762
57 / 1448	36 / 762
57 / 1448	42 / 1067
57 / 1448	48 / 1219
57 / 1448	54 / 1372
57 / 1448	60 / 1524
57 / 1448	66 / 1676

**PRICING**

**WITHOUT ACCESSORY RAIL (N) (CONTINUED)  
PARTIAL MODESTY HEIGHT (S) (CONTINUED)**

Source Laminate	Flintwood	Natural Veneer
346	700	782
375	777	828
398	854	875
422	932	944
443	1008	1065
465	1084	1183
488	1161	1304
511	1237	1421
532	1315	1544
381	769	859
415	856	912
436	941	962
462	1024	1039
487	1108	1172
513	1192	1303
537	1276	1434
559	1363	1564
585	1446	1700

**WITH ACCESSORY RAIL (A) (CONTINUED)  
PARTIAL MODESTY HEIGHT (S) (CONTINUED)**

Source Laminate	Flintwood	Natural Veneer
375	696	814
409	771	863
434	850	913
462	928	991
489	1007	1115
515	1082	1236
544	1162	1364
571	1237	1489
597	1316	1618
415	766	895
452	851	950
480	934	1005
511	1021	1091
540	1107	1227
567	1190	1361
600	1279	1500
628	1363	1637
657	1447	1779

**MODESTY HEIGHT (M)**

Source Laminate	Flintwood	Natural Veneer
259	495	544
269	540	590
281	583	641
292	630	691
359	730	803
369	776	854
381	820	901
392	863	950
328	732	806
349	815	897
369	899	989
397	974	1070
465	1101	1211
495	1185	1304
525	1275	1402
558	1364	1499
393	845	886
422	942	986
443	1039	1090
476	1124	1177
557	1273	1332
593	1369	1436
631	1474	1543
671	1574	1651
431	929	975
462	1037	1085
487	1143	1198
523	1235	1296
613	1400	1464
650	1507	1579
694	1621	1697
738	1732	1816

**MODESTY HEIGHT (M)**

Source Laminate	Flintwood	Natural Veneer
n/a	n/a	n/a
n/a	n/a	n/a
n/a	n/a	n/a
n/a	n/a	n/a
n/a	n/a	n/a
n/a	n/a	n/a
n/a	n/a	n/a
n/a	n/a	n/a
n/a	n/a	n/a
356	761	836
384	849	934
406	937	1031
437	1015	1116
513	1148	1263
544	1234	1358
581	1329	1463
619	1422	1567
422	833	916
453	929	1022
481	1027	1129
518	1112	1225
605	1256	1381
643	1355	1490
686	1459	1604
731	1561	1715
462	917	1008
497	1022	1125
527	1129	1243
571	1222	1348
665	1381	1520
708	1490	1640
755	1604	1764
805	1717	1888

If Accent/Mica is specified, add 25

Pricing is continued on the following page

**H T N S**

**Solid Desk Edge Screen (Continued)**

**DIMENSIONS  
INCHES / MM**

**PRICING**

DIMENSIONS INCHES / MM		WITHOUT ACCESSORY RAIL (N) (CONTINUED)			WITH ACCESSORY RAIL (A) (CONTINUED)		
		ELEVATED HEIGHT (E)			ELEVATED HEIGHT (E)		
H	W	Source Laminate	Flintwood	Natural Veneer	Source Laminate	Flintwood	Natural Veneer
29 / 737	24 / 610	311	643	708	n/a	n/a	n/a
29 / 737	30 / 762	323	699	768	n/a	n/a	n/a
29 / 737	36 / 762	338	760	834	n/a	n/a	n/a
29 / 737	42 / 1067	347	819	899	n/a	n/a	n/a
29 / 737	48 / 1219	429	948	1042	n/a	n/a	n/a
29 / 737	54 / 1372	443	1010	1110	n/a	n/a	n/a
29 / 737	60 / 1524	455	1065	1170	n/a	n/a	n/a
29 / 737	66 / 1676	469	1122	1234	n/a	n/a	n/a
42 / 1067	24 / 610	393	805	886	422	833	916
42 / 1067	30 / 762	422	897	986	453	929	1022
42 / 1067	36 / 762	443	989	1090	481	1027	1129
42 / 1067	42 / 1067	476	1070	1177	518	1112	1225
42 / 1067	48 / 1219	557	1210	1332	605	1256	1381
42 / 1067	54 / 1372	593	1305	1436	643	1355	1490
42 / 1067	60 / 1524	631	1404	1543	686	1459	1604
42 / 1067	66 / 1676	671	1499	1651	731	1561	1715
51 / 1295	24 / 610	392	833	916	452	925	1018
51 / 1295	30 / 762	422	929	1022	483	1031	1135
51 / 1295	36 / 762	446	1027	1129	511	1138	1252
51 / 1295	42 / 1067	482	1112	1225	548	1232	1356
51 / 1295	48 / 1219	560	1256	1381	641	1394	1531
51 / 1295	54 / 1372	600	1355	1490	681	1499	1651
51 / 1295	60 / 1524	639	1459	1604	725	1614	1776
51 / 1295	66 / 1676	680	1561	1715	769	1725	1899
DIMENSIONS INCHES / MM		FLOOR HEIGHT (F)			FLOOR HEIGHT (F)		
		Source Laminate	Flintwood	Natural Veneer	Source Laminate	Flintwood	Natural Veneer
29 / 737	24 / 610	328	732	806	n/a	n/a	n/a
29 / 737	30 / 762	349	815	897	n/a	n/a	n/a
29 / 737	36 / 762	369	899	989	n/a	n/a	n/a
29 / 737	42 / 1067	397	974	1070	n/a	n/a	n/a
29 / 737	48 / 1219	465	1101	1211	n/a	n/a	n/a
29 / 737	54 / 1372	495	1185	1304	n/a	n/a	n/a
29 / 737	60 / 1524	525	1275	1402	n/a	n/a	n/a
29 / 737	66 / 1676	558	1364	1499	n/a	n/a	n/a
42 / 1067	24 / 610	412	845	929	438	872	962
42 / 1067	30 / 762	442	942	1035	474	975	1071
42 / 1067	36 / 762	465	1040	1145	502	1075	1183
42 / 1067	42 / 1067	498	1124	1235	542	1165	1282
42 / 1067	48 / 1219	585	1273	1398	633	1317	1448
42 / 1067	54 / 1372	623	1368	1506	672	1417	1561
42 / 1067	60 / 1524	663	1471	1620	716	1528	1680
42 / 1067	66 / 1676	705	1575	1734	764	1634	1800

If Accent/Mica is specified, add 25



**G X C U**  
**Infinity Curved Desk Edge Screen**

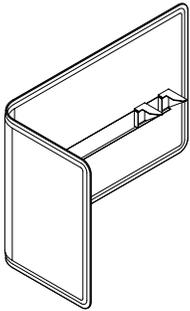

The Infinity Fabric Curved Desk Edge Screen attaches to the worksurface on both on the back and lateral edge to provide a lightweight, thin, upholstered fabric screen that is expressed in a softer curvilinear aesthetic that creates space division and local desktop privacy in varying levels.

**WHAT'S INCLUDED**

1 infinity fabric desk edge screen, attachment brackets, wire manager (if specified).

**NOTES**

The screen depth is 20" with a 1/2" wire gap around the screen.

Screen is designed to accompany an upStage Rectangle with Radius Corners Worksurface or Table with Radius Corners. Fabric will be applied in the railroad direction in select Panel and Upholstery fabrics, refer to the *Teknion Textiles Program Guide*.

**PRODUCT OPTIONS**

Modesty Base Height	Height	Depth	Width	Orientation	Screen Finish	Hardware Finish
<b>S</b> Partial Modesty Height	42 for 42" high datum	20	23, 29, 35, 41, 47, 53, 59	<b>NL</b> Left	Panel Fabrics	Foundation
<b>M</b> Modesty Height (15")	51 for 51" high datum 57 for 57" high datum			<b>NR</b> Right	Upholstery Fabrics	Mica Accent
				<b>WL</b> Left with Wire Manager		
				<b>WR</b> Right with Wire Manager		

**SAMPLE ORDER CODE**

<b>GXCU S</b>	<b>42</b>	<b>20</b>	<b>53</b>	<b>L</b>	<b>B204</b>	<b>74</b>
---------------	-----------	-----------	-----------	----------	-------------	-----------

**DIMENSIONS**  
**INCHES / MM**

H	W
42 / 1067	23 / 584
42 / 1067	29 / 737
42 / 1067	35 / 889
42 / 1067	41 / 1041
42 / 1067	47 / 1194
42 / 1067	53 / 1346
42 / 1067	59 / 1499
51 / 1295	23 / 584
51 / 1295	29 / 737
51 / 1295	35 / 889
51 / 1295	41 / 1041
51 / 1295	47 / 1194
51 / 1295	53 / 1346
51 / 1295	59 / 1499
57 / 1448	23 / 584
57 / 1448	29 / 737
57 / 1448	35 / 889
57 / 1448	41 / 1041
57 / 1448	47 / 1194
57 / 1448	53 / 1346
57 / 1448	59 / 1499

**PRICING**

PARTIAL MODESTY HEIGHT (S)																
LEFT/RIGHT (NL/NR)																
PANEL FABRIC						UPHOLSTERY FABRIC										
COM/	Gr. 1	Gr. 2	Gr. 3	Gr. 4	Gr. 5	COM/	Gr. 1	Gr. 2	Gr. 3	Gr. 4	Gr. 5	Gr. 6	Gr. 7	Gr. 8	Gr. 9	Gr. 10
1067	1078	1098	1165	1211	1257	1070	1125	1148	1181	1232	1262	1293	1355	1416	1441	
1130	1145	1166	1242	1294	1346	1135	1196	1223	1259	1316	1349	1384	1451	1521	1551	
1192	1210	1233	1316	1374	1433	1198	1266	1295	1336	1400	1437	1474	1550	1627	1659	
1326	1343	1369	1461	1524	1589	1332	1407	1438	1485	1552	1594	1633	1719	1802	1837	
1381	1402	1430	1528	1598	1667	1388	1469	1504	1552	1628	1673	1715	1809	1899	1939	
1455	1476	1507	1614	1688	1762	1463	1549	1588	1642	1723	1768	1816	1916	2014	2057	
1501	1526	1557	1673	1754	1833	1510	1603	1644	1702	1788	1840	1891	1998	2103	2150	
1466	1489	1520	1634	1715	1794	1471	1567	1605	1663	1753	1803	1855	1962	2067	2114	
1531	1558	1596	1724	1814	1904	1542	1645	1693	1756	1855	1911	1968	2088	2207	2258	
1630	1659	1701	1843	1942	2041	1641	1756	1807	1879	1987	2049	2115	2245	2377	2434	
2012	2043	2087	2244	2351	2461	2022	2149	2206	2283	2401	2471	2541	2684	2829	2890	
2099	2132	2180	2350	2469	2588	2107	2247	2307	2394	2522	2599	2673	2830	2989	3057	
2191	2228	2277	2462	2591	2720	2202	2351	2418	2511	2649	2732	2813	2983	3153	3225	
2273	2313	2367	2567	2703	2841	2285	2448	2516	2615	2765	2854	2942	3125	3307	3385	
1626	1654	1695	1839	1937	2036	1634	1753	1802	1874	1982	2046	2110	2242	2374	2430	
1720	1755	1797	1959	2071	2183	1732	1863	1920	1999	2122	2192	2265	2412	2560	2623	
1826	1865	1912	2092	2213	2337	1840	1982	2044	2133	2268	2348	2427	2591	2756	2824	
2243	2284	2338	2532	2668	2803	2257	2416	2484	2582	2728	2815	2900	3081	3260	3336	
2347	2393	2451	2661	2808	2956	2363	2533	2609	2714	2875	2968	3061	3256	3455	3538	
2490	2538	2604	2830	2990	3150	2504	2691	2773	2887	3061	3164	3268	3480	3689	3781	
2588	2639	2707	2952	3126	3298	2605	2804	2893	3016	3201	3312	3421	3649	3878	3974	

If Accent/Mica Hardware Finish is specified for depth 23" - 41", add 14  
If Accent/Mica Hardware Finish is specified for depth 47" - 59", add 29

Pricing is continued on the following page.

G X C U

Infinity Curved Desk Edge Screen  
(Continued)

DIMENSIONS  
INCHES / MM

PRICING

H		W		PARTIAL MODESTY HEIGHT (S) (CONTINUED)													
				LEFT/RIGHT WITH WIRE MANAGER (WL/WR)						UPHOLSTERY FABRIC							
PANEL FABRIC		COM/						COM/									
Gr. A	Gr. 1	Gr. 2	Gr. 3	Gr. 4	Gr. 5	Gr. 1	Gr. 2	Gr. 3	Gr. 4	Gr. 5	Gr. 6	Gr. 7	Gr. 8	Gr. 9	Gr. 10		
42 / 1067	23 / 584	1074	1087	1105	1174	1221	1266	1078	1133	1157	1190	1241	1269	1302	1363	1424	1449
42 / 1067	29 / 737	1138	1153	1175	1251	1303	1355	1144	1204	1232	1268	1326	1358	1391	1461	1529	1561
42 / 1067	35 / 889	1202	1219	1242	1326	1384	1440	1206	1275	1304	1346	1409	1445	1483	1558	1634	1670
42 / 1067	41 / 1041	1334	1354	1379	1469	1531	1597	1340	1415	1446	1492	1562	1602	1643	1726	1810	1845
42 / 1067	47 / 1194	1389	1410	1438	1538	1605	1675	1396	1477	1513	1562	1635	1681	1725	1816	1908	1948
42 / 1067	53 / 1346	1464	1486	1516	1622	1697	1771	1470	1557	1596	1650	1731	1779	1826	1925	2024	2067
42 / 1067	59 / 1499	1512	1536	1567	1681	1762	1841	1519	1611	1652	1710	1799	1848	1900	2008	2114	2159
51 / 1295	23 / 584	1474	1497	1528	1644	1725	1805	1480	1574	1615	1673	1761	1811	1863	1969	2074	2122
51 / 1295	29 / 737	1542	1568	1603	1732	1823	1912	1550	1654	1701	1764	1863	1919	1976	2097	2214	2267
51 / 1295	35 / 889	1641	1670	1709	1853	1950	2049	1649	1764	1815	1888	1995	2057	2123	2254	2387	2442
51 / 1295	41 / 1041	2021	2052	2095	2253	2361	2470	2029	2156	2213	2290	2409	2481	2549	2695	2838	2900
51 / 1295	47 / 1194	2106	2142	2189	2360	2477	2594	2117	2257	2315	2403	2531	2607	2682	2839	2998	3065
51 / 1295	53 / 1346	2199	2237	2287	2471	2600	2728	2210	2361	2426	2519	2657	2741	2823	2992	3163	3233
51 / 1295	59 / 1499	2282	2321	2377	2576	2712	2850	2296	2456	2524	2623	2774	2862	2951	3134	3316	3394
57 / 1448	23 / 584	1633	1664	1703	1846	1946	2044	1644	1761	1810	1883	1992	2056	2119	2250	2382	2440
57 / 1448	29 / 737	1728	1763	1807	1967	2079	2192	1740	1870	1927	2008	2130	2200	2272	2421	2568	2634
57 / 1448	35 / 889	1836	1873	1921	2100	2222	2345	1847	1992	2055	2144	2276	2359	2435	2600	2763	2833
57 / 1448	41 / 1041	2253	2291	2347	2541	2675	2812	2266	2424	2492	2590	2736	2823	2909	3089	3270	3345
57 / 1448	47 / 1194	2360	2403	2461	2673	2820	2967	2373	2546	2620	2727	2885	2980	3072	3270	3465	3548
57 / 1448	53 / 1346	2499	2547	2611	2839	2999	3159	2515	2699	2781	2898	3071	3172	3275	3488	3698	3790
57 / 1448	59 / 1499	2598	2645	2715	2962	3134	3305	2612	2813	2902	3026	3211	3320	3430	3658	3885	3982
H		W		MODESTY HEIGHT (M)													
				LEFT/RIGHT (NL/NR)						UPHOLSTERY FABRIC							
PANEL FABRIC		COM/						COM/									
Gr. A	Gr. 1	Gr. 2	Gr. 3	Gr. 4	Gr. 5	Gr. 1	Gr. 2	Gr. 3	Gr. 4	Gr. 5	Gr. 6	Gr. 7	Gr. 8	Gr. 9	Gr. 10		
42 / 1067	23 / 584	1320	1343	1376	1491	1570	1650	1328	1421	1463	1520	1604	1657	1707	1813	1919	1965
42 / 1067	29 / 737	1434	1460	1496	1624	1712	1802	1441	1546	1591	1655	1753	1810	1866	1983	2102	2154
42 / 1067	35 / 889	1529	1558	1598	1740	1839	1938	1539	1654	1704	1778	1884	1946	2010	2140	2272	2328
42 / 1067	41 / 1041	1709	1740	1784	1939	2048	2155	1720	1845	1900	1978	2097	2166	2236	2378	2522	2584
42 / 1067	47 / 1194	1793	1829	1876	2044	2163	2280	1806	1942	2002	2088	2214	2290	2366	2522	2680	2745
42 / 1067	53 / 1346	1885	1921	1972	2155	2284	2410	1896	2046	2109	2202	2340	2423	2502	2672	2842	2914
42 / 1067	59 / 1499	1966	2006	2061	2257	2394	2531	1978	2138	2208	2307	2456	2545	2630	2812	2993	3071
51 / 1295	23 / 584	1550	1577	1615	1750	1841	1936	1558	1670	1714	1783	1884	1944	2002	2126	2252	2303
51 / 1295	29 / 737	1637	1670	1710	1860	1965	2070	1649	1768	1823	1897	2012	2077	2146	2283	2421	2483
51 / 1295	35 / 889	1737	1773	1817	1983	2100	2214	1750	1885	1942	2026	2152	2224	2300	2454	2606	2672
51 / 1295	41 / 1041	2132	2170	2221	2403	2529	2655	2146	2291	2359	2449	2588	2668	2748	2916	3086	3156
51 / 1295	47 / 1194	2232	2273	2328	2526	2665	2802	2245	2407	2474	2576	2726	2813	2902	3086	3269	3347
51 / 1295	53 / 1346	2356	2400	2458	2673	2823	2971	2368	2545	2619	2727	2887	2985	3080	3278	3475	3561
51 / 1295	59 / 1499	2446	2493	2558	2788	2947	3109	2461	2649	2729	2846	3019	3121	3224	3437	3649	3741
57 / 1448	23 / 584	1660	1689	1726	1859	1952	2046	1671	1780	1826	1895	1994	2055	2114	2236	2359	2409
57 / 1448	29 / 737	1744	1776	1817	1969	2072	2177	1755	1877	1932	2005	2119	2185	2252	2390	2529	2588
57 / 1448	35 / 889	1848	1884	1932	2095	2210	2326	1863	1996	2054	2136	2260	2335	2408	2560	2711	2775
57 / 1448	41 / 1041	2400	2440	2495	2683	2817	2946	2413	2567	2635	2732	2875	2958	3042	3219	3391	3467
57 / 1448	47 / 1194	2501	2546	2602	2808	2951	3096	2515	2684	2758	2859	3015	3107	3199	3389	3579	3662
57 / 1448	53 / 1346	2707	2758	2822	3052	3212	3374	2726	2913	2995	3111	3284	3388	3490	3703	3917	4008
57 / 1448	59 / 1499	2819	2871	2937	3189	3360	3534	2834	3038	3126	3252	3437	3548	3659	3888	4121	4218

If Accent/Mica Hardware Finish is specified for depth 23" - 41", add 14  
If Accent/Mica Hardware Finish is specified for depth 47" - 59", add 29

Pricing is continued on the following page.

**G X C U**

**Infinity Curved Desk Edge Screen  
(Continued)**

**DIMENSIONS  
INCHES / MM**

H	W
42 / 1067	23 / 584
42 / 1067	29 / 737
42 / 1067	35 / 889
42 / 1067	41 / 1041
42 / 1067	47 / 1194
42 / 1067	53 / 1346
42 / 1067	59 / 1499
51 / 1295	23 / 584
51 / 1295	29 / 737
51 / 1295	35 / 889
51 / 1295	41 / 1041
51 / 1295	47 / 1194
51 / 1295	53 / 1346
51 / 1295	59 / 1499
57 / 1448	23 / 584
57 / 1448	29 / 737
57 / 1448	35 / 889
57 / 1448	41 / 1041
57 / 1448	47 / 1194
57 / 1448	53 / 1346
57 / 1448	59 / 1499

**PRICING**

**MODESTY HEIGHT (M) (CONTINUED)**

**LEFT/RIGHT WITH WIRE MANAGER (WL/WR)**

**PANEL FABRIC**

COM/						
Gr. A	Gr. 1	Gr. 2	Gr. 3	Gr. 4	Gr. 5	
1329	1354	1385	1499	1579	1658	
1441	1468	1504	1632	1723	1810	
1539	1568	1605	1750	1846	1946	
1719	1750	1792	1948	2056	2164	
1803	1837	1885	2054	2173	2288	
1892	1932	1981	2164	2291	2420	
1973	2014	2070	2266	2403	2540	
1558	1588	1624	1757	1850	1944	
1648	1677	1720	1869	1972	2077	
1748	1781	1828	1994	2107	2223	
2142	2179	2229	2410	2538	2666	
2244	2284	2338	2538	2674	2813	
2364	2408	2468	2682	2830	2980	
2455	2501	2564	2796	2956	3117	
1670	1697	1734	1869	1962	2055	
1754	1785	1826	1976	2082	2184	
1858	1895	1938	2104	2220	2334	
2408	2449	2501	2691	2824	2954	
2510	2554	2609	2818	2960	3102	
2717	2765	2829	3059	3221	3380	
2826	2880	2948	3196	3368	3543	

**UPHOLSTERY FABRIC**

COM/									
Gr. 1	Gr. 2	Gr. 3	Gr. 4	Gr. 5	Gr. 6	Gr. 7	Gr. 8	Gr. 9	Gr. 10
1336	1431	1470	1528	1614	1666	1715	1820	1928	1972
1449	1553	1599	1663	1761	1817	1875	1994	2112	2163
1547	1662	1712	1785	1891	1956	2019	2149	2280	2336
1727	1855	1909	1988	2104	2176	2244	2388	2531	2592
1814	1950	2012	2097	2223	2300	2375	2531	2689	2755
1906	2055	2119	2210	2349	2431	2513	2681	2852	2922
1988	2148	2216	2315	2465	2552	2639	2822	3004	3080
1568	1677	1724	1791	1891	1951	2012	2134	2259	2312
1657	1779	1832	1907	2021	2087	2153	2290	2430	2490
1757	1892	1950	2035	2160	2235	2308	2461	2614	2681
2153	2302	2366	2457	2594	2675	2758	2926	3094	3165
2257	2419	2487	2588	2736	2825	2913	3096	3279	3359
2378	2552	2627	2735	2896	2993	3089	3285	3485	3569
2470	2657	2737	2854	3029	3131	3232	3445	3659	3750
1679	1787	1836	1903	2001	2061	2120	2243	2367	2419
1763	1886	1939	2012	2126	2193	2259	2397	2534	2593
1871	2003	2061	2146	2269	2344	2418	2568	2719	2787
2423	2576	2642	2741	2882	2966	3052	3225	3402	3475
2524	2694	2764	2869	3026	3117	3208	3398	3589	3669
2734	2921	3004	3119	3294	3395	3498	3709	3924	4015
2843	3048	3134	3260	3445	3556	3668	3896	4127	4225

If Accent/Mica Hardware Finish is specified for depth 23" - 41", add 14

If Accent/Mica Hardware Finish is specified for depth 47" - 59", add 29



## G X D U

### Infinity Desk Edge Screen

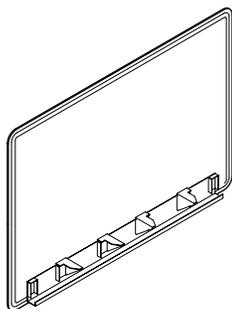

The Infinity Desk Edge Screen attaches to a worksurface to provide a lightweight, thin, upholstered fabric screen that is expressed in a softer curvilinear aesthetic that creates space division and local desktop privacy in varying levels.

#### WHAT'S INCLUDED

1 Infinity fabric desk edge screen, attachment brackets, wire manager (if specified).

#### NOTES

Infinity screen is 1/2" less than specified size. The worksurface wire gap is 1/2", to allow for mounting of select desk edge accessories.

Wire manager is designed to be accompanied by the Power Bar (YEPD) or Compact Power Bar (YEPS).

The screen is available in select Panel and Upholstery fabrics, refer to the *Teknion Textiles Program Guide*.

#### PRODUCT OPTIONS

Modesty Base Height	Height	Width (in 1" increments)	Wire Manager	Screen Finish	Hardware Finish
<b>S</b> Partial Modesty Height	42 for 42" high datum	36 - 71	<b>Y</b> Yes	Panel Fabrics	Foundation
<b>M</b> Modesty Height (15")	51 for 51" high datum		<b>N</b> No	Upholstery Fabrics	Mica
	57 for 57" high datum				Accent

#### SAMPLE ORDER CODE

<b>GXDU S</b>	<b>42</b>	<b>60</b>	<b>Y</b>	<b>B204</b>	<b>74</b>
---------------	-----------	-----------	----------	-------------	-----------

See Pricing on the following page.



**G X D U**  
**Infinity Desk Edge Screen**  
**(Continued)**

**DIMENSIONS**  
**INCHES / MM**

H	W
42 / 1067	36 / 914
42 / 1067	37 / 940
42 / 1067	38 / 965
42 / 1067	39 / 991
42 / 1067	40 / 1016
42 / 1067	41 / 1041
42 / 1067	42 / 1067
42 / 1067	43 / 1092
42 / 1067	44 / 1118
42 / 1067	45 / 1143
42 / 1067	46 / 1168
42 / 1067	47 / 1194
42 / 1067	48 / 1219
42 / 1067	49 / 1245
42 / 1067	50 / 1270
42 / 1067	51 / 1295
42 / 1067	52 / 1321
42 / 1067	53 / 1346
42 / 1067	54 / 1372
42 / 1067	55 / 1397
42 / 1067	56 / 1422
42 / 1067	57 / 1448
42 / 1067	58 / 1473
42 / 1067	59 / 1499
42 / 1067	60 / 1524
42 / 1067	61 / 1549
42 / 1067	62 / 1575
42 / 1067	63 / 1600
42 / 1067	64 / 1626
42 / 1067	65 / 1651
42 / 1067	66 / 1676
42 / 1067	67 / 1702
42 / 1067	68 / 1727
42 / 1067	69 / 1753
42 / 1067	70 / 1778
42 / 1067	71 / 1803

**PRICING**

PARTIAL MODESTY HEIGHT (S)															
NO WIRE MANAGER (N)															
PANEL FABRIC							UPHOLSTERY FABRIC								
COM/ Gr. A	Gr. 1	Gr. 2	Gr. 3	Gr. 4	Gr. 5	COM/ Gr. 1	Gr. 2	Gr. 3	Gr. 4	Gr. 5	Gr. 6	Gr. 7	Gr. 8	Gr. 9	Gr. 10
890	901	917	971	1008	1044	894	937	955	984	1023	1048	1071	1122	1172	1192
890	901	917	973	1010	1048	894	940	958	986	1027	1051	1075	1127	1177	1200
889	901	917	974	1012	1051	894	941	959	988	1030	1055	1080	1131	1183	1206
929	942	958	1015	1055	1097	935	980	1002	1030	1074	1099	1125	1177	1232	1255
929	942	959	1018	1058	1099	935	981	1003	1033	1076	1102	1129	1183	1237	1262
929	942	959	1019	1061	1102	934	984	1004	1034	1080	1105	1133	1190	1244	1268
969	980	997	1060	1102	1145	973	1022	1044	1075	1122	1150	1176	1233	1289	1315
967	980	997	1061	1104	1150	973	1023	1045	1076	1125	1153	1181	1237	1298	1323
967	980	1000	1064	1107	1152	973	1023	1046	1080	1128	1157	1185	1244	1304	1329
1010	1022	1041	1105	1152	1198	1014	1068	1091	1124	1173	1203	1232	1293	1354	1379
1010	1022	1041	1108	1155	1202	1014	1069	1092	1125	1175	1205	1235	1298	1359	1386
1010	1022	1041	1110	1158	1205	1014	1069	1094	1128	1180	1210	1241	1303	1365	1393
1049	1065	1084	1153	1203	1251	1055	1112	1136	1172	1225	1255	1286	1349	1415	1441
1049	1065	1084	1155	1204	1255	1054	1112	1137	1174	1227	1258	1289	1356	1419	1448
1049	1065	1084	1157	1206	1257	1054	1113	1138	1175	1230	1262	1295	1361	1427	1457
1084	1099	1120	1195	1244	1296	1090	1150	1175	1211	1267	1302	1334	1402	1469	1498
1084	1099	1121	1196	1249	1299	1090	1150	1176	1214	1269	1304	1336	1407	1475	1506
1083	1099	1121	1197	1251	1304	1090	1151	1177	1215	1274	1309	1341	1411	1483	1513
1116	1131	1153	1232	1286	1340	1122	1185	1213	1252	1310	1343	1379	1449	1522	1552
1116	1131	1153	1233	1287	1343	1122	1185	1214	1253	1312	1348	1384	1457	1528	1561
1116	1131	1155	1235	1289	1347	1121	1188	1214	1256	1316	1353	1387	1463	1537	1568
1180	1196	1219	1302	1357	1414	1183	1251	1280	1320	1384	1418	1455	1529	1605	1637
1177	1196	1219	1303	1359	1417	1183	1252	1281	1323	1386	1421	1460	1537	1611	1645
1177	1196	1219	1304	1363	1419	1183	1253	1282	1326	1388	1426	1464	1542	1620	1652
1241	1257	1282	1366	1427	1487	1248	1315	1346	1388	1453	1492	1529	1609	1688	1723
1241	1257	1282	1368	1430	1490	1248	1316	1347	1391	1457	1496	1536	1615	1695	1728
1241	1257	1282	1371	1433	1494	1248	1317	1348	1393	1460	1499	1539	1620	1702	1735
1264	1283	1310	1398	1461	1522	1273	1343	1376	1419	1489	1528	1569	1651	1734	1768
1264	1283	1310	1400	1464	1527	1269	1346	1378	1422	1492	1531	1573	1657	1740	1778
1264	1283	1310	1402	1467	1529	1269	1346	1379	1424	1496	1537	1577	1662	1749	1784
1289	1310	1335	1430	1496	1561	1296	1373	1407	1453	1524	1567	1607	1695	1781	1816
1289	1310	1336	1433	1497	1564	1296	1374	1408	1455	1527	1569	1611	1701	1786	1824
1289	1310	1336	1434	1499	1568	1296	1374	1409	1459	1529	1573	1618	1704	1793	1832
1315	1335	1363	1461	1528	1597	1323	1402	1437	1486	1558	1602	1648	1735	1828	1866
1340	1359	1387	1487	1556	1626	1347	1427	1463	1512	1588	1630	1674	1765	1858	1897
1340	1359	1388	1489	1558	1628	1346	1427	1464	1514	1590	1633	1679	1773	1865	1906

If Accent/Mica Hardware Finish is specified for depth 36" - 42", add 14  
If Accent/Mica Hardware Finish is specified for depth 43" - 71", add 29

Pricing is continued on the following page.

G X D U

Infinity Desk Edge Screen  
(Continued)

DIMENSIONS  
INCHES / MM

H	W
51 / 1295	36 / 914
51 / 1295	37 / 940
51 / 1295	38 / 965
51 / 1295	39 / 991
51 / 1295	40 / 1016
51 / 1295	41 / 1041
51 / 1295	42 / 1067
51 / 1295	43 / 1092
51 / 1295	44 / 1118
51 / 1295	45 / 1143
51 / 1295	46 / 1168
51 / 1295	47 / 1194
51 / 1295	48 / 1219
51 / 1295	49 / 1245
51 / 1295	50 / 1270
51 / 1295	51 / 1295
51 / 1295	52 / 1321
51 / 1295	53 / 1346
51 / 1295	54 / 1372
51 / 1295	55 / 1397
51 / 1295	56 / 1422
51 / 1295	57 / 1448
51 / 1295	58 / 1473
51 / 1295	59 / 1499
51 / 1295	60 / 1524
51 / 1295	61 / 1549
51 / 1295	62 / 1575
51 / 1295	63 / 1600
51 / 1295	64 / 1626
51 / 1295	65 / 1651
51 / 1295	66 / 1676
51 / 1295	67 / 1702
51 / 1295	68 / 1727
51 / 1295	69 / 1753
51 / 1295	70 / 1778
51 / 1295	71 / 1803

PRICING

PARTIAL MODESTY HEIGHT (S) (CONTINUED)															
NO WIRE MANAGER (N) (CONTINUED)															
PANEL FABRIC							UPHOLSTERY FABRIC								
COM/ Gr. A	Gr. 1	Gr. 2	Gr. 3	Gr. 4	Gr. 5	COM/ Gr. 1	Gr. 2	Gr. 3	Gr. 4	Gr. 5	Gr. 6	Gr. 7	Gr. 8	Gr. 9	Gr. 10
1130	1150	1175	1267	1332	1395	1136	1211	1244	1289	1359	1402	1441	1527	1611	1649
1130	1150	1175	1269	1335	1402	1136	1213	1248	1294	1365	1408	1448	1538	1624	1660
1129	1150	1176	1274	1341	1408	1136	1214	1250	1298	1371	1414	1457	1546	1634	1674
1182	1203	1230	1329	1398	1467	1190	1269	1305	1355	1430	1474	1517	1609	1701	1738
1182	1203	1232	1333	1404	1474	1189	1273	1306	1358	1436	1478	1524	1619	1711	1753
1181	1203	1232	1335	1408	1478	1189	1274	1310	1361	1439	1486	1530	1628	1724	1764
1234	1256	1286	1391	1466	1539	1242	1328	1365	1418	1498	1546	1594	1689	1787	1830
1234	1256	1286	1394	1469	1546	1242	1329	1366	1421	1504	1551	1600	1701	1800	1843
1233	1256	1286	1396	1474	1551	1241	1332	1369	1426	1509	1558	1607	1709	1811	1856
1302	1324	1356	1468	1547	1626	1309	1400	1440	1497	1581	1632	1682	1786	1890	1936
1302	1324	1356	1470	1551	1630	1309	1402	1441	1499	1589	1637	1689	1797	1903	1948
1299	1324	1357	1474	1556	1637	1309	1404	1445	1504	1592	1645	1697	1806	1914	1961
1365	1389	1422	1543	1627	1710	1374	1470	1513	1573	1663	1719	1771	1883	1992	2040
1365	1389	1424	1546	1630	1715	1373	1471	1516	1577	1671	1724	1779	1890	2002	2052
1364	1389	1424	1549	1634	1723	1373	1474	1519	1580	1674	1731	1785	1900	2014	2063
1410	1437	1471	1598	1687	1776	1418	1521	1567	1630	1726	1783	1839	1956	2072	2123
1410	1437	1471	1600	1693	1781	1418	1522	1569	1633	1732	1787	1845	1966	2084	2134
1409	1437	1471	1604	1696	1786	1417	1526	1572	1635	1735	1794	1854	1973	2095	2148
1453	1480	1519	1652	1746	1837	1463	1572	1619	1685	1786	1845	1906	2028	2152	2206
1453	1480	1519	1655	1750	1844	1463	1573	1621	1688	1791	1853	1912	2039	2163	2217
1451	1480	1520	1658	1754	1850	1463	1574	1622	1694	1797	1859	1919	2048	2176	2229
1539	1568	1605	1749	1844	1942	1547	1662	1711	1783	1889	1950	2014	2144	2273	2329
1539	1568	1607	1751	1850	1948	1547	1663	1714	1786	1892	1957	2022	2153	2284	2342
1538	1568	1607	1754	1855	1956	1547	1666	1715	1788	1899	1965	2028	2163	2297	2352
1624	1654	1695	1843	1945	2048	1633	1754	1806	1881	1992	2056	2123	2258	2394	2454
1624	1654	1696	1845	1949	2054	1633	1755	1809	1884	1996	2063	2130	2269	2405	2465
1622	1654	1696	1848	1953	2059	1632	1756	1810	1886	2001	2070	2137	2276	2418	2477
1675	1707	1751	1906	2012	2120	1685	1811	1866	1944	2061	2129	2197	2340	2483	2545
1675	1707	1751	1908	2016	2125	1685	1813	1869	1946	2064	2134	2206	2349	2493	2554
1674	1707	1753	1911	2022	2131	1685	1814	1870	1950	2071	2142	2212	2360	2504	2568
1726	1758	1805	1966	2077	2189	1735	1867	1925	2006	2129	2199	2272	2420	2568	2634
1726	1758	1805	1968	2082	2196	1735	1870	1926	2010	2132	2207	2277	2430	2581	2644
1725	1758	1806	1971	2087	2202	1735	1871	1930	2013	2138	2212	2285	2439	2592	2657
1763	1799	1844	2013	2130	2246	1776	1912	1971	2055	2182	2257	2333	2487	2643	2710
1802	1836	1884	2054	2173	2289	1811	1950	2010	2097	2224	2302	2377	2533	2694	2759
1800	1836	1884	2056	2177	2298	1811	1951	2013	2100	2230	2307	2382	2545	2703	2772

If Accent/Mica Hardware Finish is specified for depth 36" - 42", add 14  
If Accent/Mica Hardware Finish is specified for depth 43" - 71", add 29

Pricing is continued on the following page.

**G X D U**  
**Infinity Desk Edge Screen**  
**(Continued)**

**DIMENSIONS**  
**INCHES / MM**

H	W
57 / 1448	36 / 914
57 / 1448	37 / 940
57 / 1448	38 / 965
57 / 1448	39 / 991
57 / 1448	40 / 1016
57 / 1448	41 / 1041
57 / 1448	42 / 1067
57 / 1448	43 / 1092
57 / 1448	44 / 1118
57 / 1448	45 / 1143
57 / 1448	46 / 1168
57 / 1448	47 / 1194
57 / 1448	48 / 1219
57 / 1448	49 / 1245
57 / 1448	50 / 1270
57 / 1448	51 / 1295
57 / 1448	52 / 1321
57 / 1448	53 / 1346
57 / 1448	54 / 1372
57 / 1448	55 / 1397
57 / 1448	56 / 1422
57 / 1448	57 / 1448
57 / 1448	58 / 1473
57 / 1448	59 / 1499
57 / 1448	60 / 1524
57 / 1448	61 / 1549
57 / 1448	62 / 1575
57 / 1448	63 / 1600
57 / 1448	64 / 1626
57 / 1448	65 / 1651
57 / 1448	66 / 1676
57 / 1448	67 / 1702
57 / 1448	68 / 1727
57 / 1448	69 / 1753
57 / 1448	70 / 1778
57 / 1448	71 / 1803

**PRICING**

<b>PARTIAL MODESTY HEIGHT (S) (CONTINUED)</b>															
<b>NO WIRE MANAGER (N) (CONTINUED)</b>															
<b>PANEL FABRIC</b>							<b>UPHOLSTERY FABRIC</b>								
COM/ Gr. A	Gr. 1	Gr. 2	Gr. 3	Gr. 4	Gr. 5	COM/ Gr. 1	Gr. 2	Gr. 3	Gr. 4	Gr. 5	Gr. 6	Gr. 7	Gr. 8	Gr. 9	Gr. 10
1124	1143	1170	1264	1333	1398	1129	1206	1242	1288	1363	1406	1447	1537	1626	1662
1124	1143	1170	1264	1333	1398	1129	1206	1242	1288	1363	1406	1447	1537	1626	1662
1124	1143	1170	1264	1333	1398	1129	1206	1242	1288	1363	1406	1447	1537	1626	1662
1175	1196	1225	1328	1398	1470	1181	1264	1303	1354	1431	1476	1522	1619	1712	1754
1175	1196	1225	1328	1398	1470	1181	1264	1303	1354	1431	1476	1522	1619	1712	1754
1175	1196	1225	1328	1398	1470	1181	1264	1303	1354	1431	1476	1522	1619	1712	1754
1226	1249	1279	1388	1466	1540	1233	1323	1359	1416	1498	1547	1597	1697	1800	1843
1226	1249	1279	1388	1466	1540	1233	1323	1359	1416	1498	1547	1597	1697	1800	1843
1226	1249	1279	1388	1466	1540	1233	1323	1359	1416	1498	1547	1597	1697	1800	1843
1293	1315	1348	1466	1546	1627	1299	1394	1436	1494	1581	1633	1685	1793	1903	1948
1293	1315	1348	1466	1546	1627	1299	1394	1436	1494	1581	1633	1685	1793	1903	1948
1293	1315	1348	1466	1546	1627	1299	1394	1436	1494	1581	1633	1685	1793	1903	1948
1358	1384	1417	1542	1627	1712	1365	1467	1510	1572	1666	1721	1776	1889	2003	2052
1358	1384	1417	1542	1627	1712	1365	1467	1510	1572	1666	1721	1776	1889	2003	2052
1358	1384	1417	1542	1627	1712	1365	1467	1510	1572	1666	1721	1776	1889	2003	2052
1400	1426	1463	1594	1684	1776	1408	1514	1561	1627	1725	1783	1840	1962	2080	2132
1400	1426	1463	1594	1684	1776	1408	1514	1561	1627	1725	1783	1840	1962	2080	2132
1400	1426	1463	1594	1684	1776	1408	1514	1561	1627	1725	1783	1840	1962	2080	2132
1440	1468	1507	1644	1738	1835	1448	1561	1609	1679	1783	1843	1906	2029	2156	2212
1440	1468	1507	1644	1738	1835	1448	1561	1609	1679	1783	1843	1906	2029	2156	2212
1440	1468	1507	1644	1738	1835	1448	1561	1609	1679	1783	1843	1906	2029	2156	2212
1526	1553	1596	1738	1839	1939	1536	1652	1703	1776	1885	1948	2013	2147	2277	2336
1526	1553	1596	1738	1839	1939	1536	1652	1703	1776	1885	1948	2013	2147	2277	2336
1526	1553	1596	1738	1839	1939	1536	1652	1703	1776	1885	1948	2013	2147	2277	2336
1609	1641	1681	1833	1938	2043	1619	1741	1794	1870	1983	2052	2120	2258	2397	2458
1609	1641	1681	1833	1938	2043	1619	1741	1794	1870	1983	2052	2120	2258	2397	2458
1609	1641	1681	1833	1938	2043	1619	1741	1794	1870	1983	2052	2120	2258	2397	2458
1660	1694	1735	1895	2003	2115	1672	1800	1855	1936	2054	2124	2194	2340	2486	2548
1660	1694	1735	1895	2003	2115	1672	1800	1855	1936	2054	2124	2194	2340	2486	2548
1660	1694	1735	1895	2003	2115	1672	1800	1855	1936	2054	2124	2194	2340	2486	2548
1711	1746	1791	1956	2071	2184	1723	1856	1914	1997	2122	2194	2269	2420	2574	2638
1711	1746	1791	1956	2071	2184	1723	1856	1914	1997	2122	2194	2269	2420	2574	2638
1711	1746	1791	1956	2071	2184	1723	1856	1914	1997	2122	2194	2269	2420	2574	2638
1749	1783	1829	1996	2114	2228	1758	1895	1953	2039	2164	2238	2313	2468	2621	2689
1784	1818	1867	2042	2163	2284	1794	1937	1998	2087	2217	2296	2371	2532	2695	2762
1784	1818	1867	2042	2163	2284	1794	1937	1998	2087	2217	2296	2371	2532	2695	2762

If Accent/Mica Hardware Finish is specified for depth 36" - 42", add 14  
If Accent/Mica Hardware Finish is specified for depth 43" - 71", add 29

Pricing is continued on the following page.

## G X D U

### Infinity Desk Edge Screen (Continued)

#### DIMENSIONS INCHES / MM

H	W
42 / 1067	36 / 914
42 / 1067	37 / 940
42 / 1067	38 / 965
42 / 1067	39 / 991
42 / 1067	40 / 1016
42 / 1067	41 / 1041
42 / 1067	42 / 1067
42 / 1067	43 / 1092
42 / 1067	44 / 1118
42 / 1067	45 / 1143
42 / 1067	46 / 1168
42 / 1067	47 / 1194
42 / 1067	48 / 1219
42 / 1067	49 / 1245
42 / 1067	50 / 1270
42 / 1067	51 / 1295
42 / 1067	52 / 1321
42 / 1067	53 / 1346
42 / 1067	54 / 1372
42 / 1067	55 / 1397
42 / 1067	56 / 1422
42 / 1067	57 / 1448
42 / 1067	58 / 1473
42 / 1067	59 / 1499
42 / 1067	60 / 1524
42 / 1067	61 / 1549
42 / 1067	62 / 1575
42 / 1067	63 / 1600
42 / 1067	64 / 1626
42 / 1067	65 / 1651
42 / 1067	66 / 1676
42 / 1067	67 / 1702
42 / 1067	68 / 1727
42 / 1067	69 / 1753
42 / 1067	70 / 1778
42 / 1067	71 / 1803

#### PRICING

##### PARTIAL MODESTY HEIGHT (S) (CONTINUED)

##### WITH WIRE MANAGER (Y)

##### PANEL FABRIC

COM/ Gr. A	Gr. 1	Gr. 2	Gr. 3	Gr. 4	Gr. 5
899	911	925	979	1016	1053
899	911	925	980	1018	1057
898	911	925	981	1021	1060
940	950	966	1023	1065	1104
940	950	967	1027	1068	1107
940	950	967	1028	1070	1112
978	989	1007	1069	1112	1153
977	989	1007	1070	1113	1158
977	989	1008	1071	1116	1161
1018	1031	1049	1115	1161	1206
1018	1031	1049	1118	1163	1210
1018	1031	1049	1120	1166	1214
1058	1072	1094	1162	1211	1258
1058	1072	1094	1163	1213	1263
1058	1072	1094	1165	1215	1266
1094	1107	1128	1203	1253	1305
1094	1107	1129	1204	1256	1309
1092	1107	1129	1205	1258	1312
1125	1142	1162	1241	1295	1348
1125	1142	1162	1242	1296	1354
1125	1142	1163	1244	1299	1356
1189	1204	1227	1310	1365	1421
1188	1204	1227	1311	1368	1426
1188	1204	1227	1312	1371	1430
1250	1266	1289	1376	1437	1496
1250	1266	1289	1378	1438	1498
1250	1266	1289	1380	1440	1501
1274	1293	1317	1408	1469	1530
1274	1293	1317	1409	1471	1537
1274	1293	1317	1410	1475	1539
1299	1317	1343	1438	1504	1569
1299	1317	1346	1440	1506	1572
1299	1317	1346	1441	1509	1575
1324	1343	1371	1469	1538	1604
1348	1368	1395	1496	1566	1633
1348	1368	1396	1497	1568	1635

##### UPHOLSTERY FABRIC

COM/ Gr. 1	Gr. 2	Gr. 3	Gr. 4	Gr. 5	Gr. 6	Gr. 7	Gr. 8	Gr. 9	Gr. 10
902	947	965	992	1033	1057	1080	1130	1180	1202
902	948	966	995	1035	1060	1084	1135	1188	1207
902	949	967	996	1039	1065	1090	1142	1192	1215
943	989	1010	1039	1083	1107	1133	1188	1241	1263
943	991	1011	1041	1085	1112	1137	1192	1249	1269
942	992	1012	1042	1090	1115	1143	1198	1253	1279
980	1031	1053	1084	1130	1158	1185	1242	1299	1324
980	1033	1054	1085	1133	1162	1190	1249	1306	1332
980	1033	1055	1090	1136	1165	1195	1253	1312	1338
1022	1075	1099	1131	1181	1211	1241	1302	1361	1387
1022	1076	1100	1133	1183	1214	1244	1306	1368	1394
1022	1076	1101	1136	1189	1219	1250	1311	1374	1402
1065	1121	1145	1180	1233	1263	1295	1358	1422	1449
1064	1121	1146	1182	1235	1267	1299	1364	1430	1459
1064	1122	1148	1183	1237	1269	1304	1369	1437	1466
1098	1158	1183	1221	1276	1310	1342	1410	1477	1507
1098	1158	1185	1223	1280	1312	1346	1415	1485	1514
1098	1160	1188	1225	1282	1316	1349	1419	1491	1521
1130	1195	1222	1259	1317	1354	1387	1460	1530	1562
1130	1195	1223	1262	1320	1357	1391	1466	1538	1569
1129	1196	1223	1264	1326	1359	1395	1470	1544	1575
1192	1258	1287	1329	1391	1427	1464	1539	1615	1648
1192	1259	1288	1332	1394	1431	1468	1544	1621	1654
1192	1262	1289	1334	1396	1436	1471	1550	1628	1660
1255	1324	1355	1396	1463	1500	1539	1619	1697	1731
1255	1326	1356	1400	1466	1504	1543	1624	1703	1737
1255	1327	1357	1402	1468	1509	1547	1628	1710	1746
1281	1354	1385	1430	1497	1538	1577	1659	1742	1779
1280	1355	1386	1433	1500	1542	1581	1666	1750	1785
1280	1355	1387	1434	1504	1544	1588	1672	1756	1792
1305	1381	1415	1463	1531	1574	1618	1703	1788	1826
1305	1384	1416	1464	1537	1577	1621	1709	1794	1833
1305	1384	1417	1467	1539	1581	1626	1712	1803	1840
1332	1410	1445	1494	1568	1610	1655	1746	1836	1875
1356	1437	1470	1520	1596	1641	1682	1776	1866	1907
1355	1437	1471	1522	1598	1643	1687	1781	1873	1914

If Accent/Mica Hardware Finish is specified for depth 36" - 42", add 14

If Accent/Mica Hardware Finish is specified for depth 43" - 71", add 29

Pricing is continued on the following page.

**G X D U**  
**Infinity Desk Edge Screen**  
**(Continued)**

**DIMENSIONS**  
**INCHES / MM**

H	W
51 / 1295	36 / 914
51 / 1295	37 / 940
51 / 1295	38 / 965
51 / 1295	39 / 991
51 / 1295	40 / 1016
51 / 1295	41 / 1041
51 / 1295	42 / 1067
51 / 1295	43 / 1092
51 / 1295	44 / 1118
51 / 1295	45 / 1143
51 / 1295	46 / 1168
51 / 1295	47 / 1194
51 / 1295	48 / 1219
51 / 1295	49 / 1245
51 / 1295	50 / 1270
51 / 1295	51 / 1295
51 / 1295	52 / 1321
51 / 1295	53 / 1346
51 / 1295	54 / 1372
51 / 1295	55 / 1397
51 / 1295	56 / 1422
51 / 1295	57 / 1448
51 / 1295	58 / 1473
51 / 1295	59 / 1499
51 / 1295	60 / 1524
51 / 1295	61 / 1549
51 / 1295	62 / 1575
51 / 1295	63 / 1600
51 / 1295	64 / 1626
51 / 1295	65 / 1651
51 / 1295	66 / 1676
51 / 1295	67 / 1702
51 / 1295	68 / 1727
51 / 1295	69 / 1753
51 / 1295	70 / 1778
51 / 1295	71 / 1803

**PRICING**

PARTIAL MODESTY HEIGHT (S) (CONTINUED)															
WITH WIRE MANAGER (Y) (CONTINUED)															
PANEL FABRIC							UPHOLSTERY FABRIC								
COM/ Gr. A	Gr. 1	Gr. 2	Gr. 3	Gr. 4	Gr. 5	COM/ Gr. 1	Gr. 2	Gr. 3	Gr. 4	Gr. 5	Gr. 6	Gr. 7	Gr. 8	Gr. 9	Gr. 10
1138	1158	1183	1276	1340	1406	1145	1221	1253	1299	1368	1410	1449	1537	1621	1657
1138	1158	1183	1280	1343	1410	1145	1222	1255	1303	1374	1416	1459	1546	1632	1671
1137	1158	1185	1282	1349	1416	1145	1223	1257	1306	1380	1421	1466	1553	1644	1682
1191	1211	1237	1338	1408	1475	1198	1280	1313	1363	1438	1483	1526	1619	1709	1749
1191	1211	1241	1341	1411	1483	1197	1281	1315	1366	1444	1489	1531	1627	1721	1761
1190	1211	1241	1343	1416	1489	1197	1282	1317	1369	1447	1494	1540	1635	1732	1775
1243	1264	1295	1400	1474	1547	1251	1336	1374	1427	1507	1553	1602	1700	1797	1839
1243	1264	1295	1404	1477	1553	1251	1338	1376	1431	1513	1561	1609	1709	1809	1853
1242	1264	1295	1407	1483	1561	1250	1340	1379	1436	1517	1568	1618	1719	1818	1865
1310	1333	1364	1476	1556	1633	1316	1409	1448	1506	1591	1642	1693	1794	1899	1944
1310	1333	1364	1478	1561	1641	1316	1410	1449	1509	1597	1648	1700	1806	1911	1957
1309	1333	1365	1483	1566	1648	1316	1411	1453	1513	1600	1654	1705	1814	1921	1968
1374	1398	1433	1551	1634	1720	1384	1478	1521	1581	1673	1726	1780	1890	1999	2048
1374	1398	1434	1553	1641	1725	1381	1480	1524	1588	1679	1732	1786	1899	2012	2061
1373	1398	1434	1557	1644	1731	1381	1483	1527	1590	1682	1738	1793	1909	2024	2072
1418	1445	1480	1605	1696	1784	1427	1529	1574	1641	1734	1791	1846	1965	2080	2131
1418	1445	1480	1609	1701	1788	1427	1530	1577	1643	1740	1797	1855	1973	2093	2146
1417	1445	1480	1614	1704	1794	1426	1536	1580	1645	1746	1805	1861	1982	2103	2155
1463	1490	1527	1660	1754	1845	1470	1580	1627	1695	1794	1855	1914	2039	2160	2213
1463	1490	1527	1663	1757	1854	1470	1581	1629	1697	1800	1860	1920	2046	2173	2227
1461	1490	1528	1667	1762	1859	1470	1582	1630	1702	1806	1867	1928	2056	2183	2238
1547	1575	1615	1756	1854	1950	1556	1672	1721	1791	1897	1961	2024	2152	2282	2337
1547	1575	1618	1758	1859	1957	1556	1673	1724	1794	1903	1966	2029	2161	2291	2350
1546	1575	1618	1762	1863	1965	1556	1674	1725	1799	1908	1972	2039	2173	2305	2363
1632	1662	1703	1853	1953	2056	1643	1762	1814	1889	1999	2064	2131	2267	2403	2461
1632	1662	1704	1855	1959	2062	1643	1763	1816	1891	2003	2072	2138	2276	2413	2472
1630	1662	1704	1858	1964	2069	1642	1764	1817	1895	2010	2077	2147	2285	2426	2486
1684	1715	1758	1914	2021	2129	1695	1818	1875	1951	2070	2137	2207	2349	2490	2552
1684	1715	1758	1916	2025	2133	1695	1820	1877	1956	2073	2146	2213	2359	2501	2563
1682	1715	1761	1919	2029	2140	1695	1823	1879	1961	2079	2150	2221	2367	2514	2577
1734	1767	1813	1973	2087	2197	1746	1876	1935	2014	2137	2208	2280	2428	2577	2642
1734	1767	1813	1976	2092	2206	1746	1879	1936	2019	2142	2214	2287	2439	2590	2653
1733	1767	1814	1980	2095	2210	1746	1881	1938	2022	2148	2221	2296	2448	2602	2667
1773	1807	1854	2022	2138	2255	1784	1920	1980	2063	2191	2266	2340	2496	2652	2719
1810	1844	1891	2062	2180	2299	1818	1961	2019	2104	2235	2310	2387	2543	2701	2767
1809	1844	1891	2064	2184	2306	1818	1962	2022	2107	2239	2315	2393	2552	2712	2780

If Accent/Mica Hardware Finish is specified for depth 36" - 42", add 14  
If Accent/Mica Hardware Finish is specified for depth 43" - 71", add 29

Pricing is continued on the following page.

G X D U

Infinity Desk Edge Screen  
(Continued)

DIMENSIONS  
INCHES / MM

H	W
57 / 1448	36 / 914
57 / 1448	37 / 940
57 / 1448	38 / 965
57 / 1448	39 / 991
57 / 1448	40 / 1016
57 / 1448	41 / 1041
57 / 1448	42 / 1067
57 / 1448	43 / 1092
57 / 1448	44 / 1118
57 / 1448	45 / 1143
57 / 1448	46 / 1168
57 / 1448	47 / 1194
57 / 1448	48 / 1219
57 / 1448	49 / 1245
57 / 1448	50 / 1270
57 / 1448	51 / 1295
57 / 1448	52 / 1321
57 / 1448	53 / 1346
57 / 1448	54 / 1372
57 / 1448	55 / 1397
57 / 1448	56 / 1422
57 / 1448	57 / 1448
57 / 1448	58 / 1473
57 / 1448	59 / 1499
57 / 1448	60 / 1524
57 / 1448	61 / 1549
57 / 1448	62 / 1575
57 / 1448	63 / 1600
57 / 1448	64 / 1626
57 / 1448	65 / 1651
57 / 1448	66 / 1676
57 / 1448	67 / 1702
57 / 1448	68 / 1727
57 / 1448	69 / 1753
57 / 1448	70 / 1778
57 / 1448	71 / 1803

PRICING

PARTIAL MODESTY HEIGHT (S) (CONTINUED)  
WITH WIRE MANAGER (Y) (CONTINUED)

PANEL FABRIC							UPHOLSTERY FABRIC									
COM/							COM/									
Gr. A	Gr. 1	Gr. 2	Gr. 3	Gr. 4	Gr. 5		Gr. 1	Gr. 2	Gr. 3	Gr. 4	Gr. 5	Gr. 6	Gr. 7	Gr. 8	Gr. 9	Gr. 10
1131	1151	1177	1274	1341	1408		1137	1215	1251	1298	1371	1414	1457	1544	1633	1672
1131	1151	1177	1274	1341	1408		1137	1215	1251	1298	1371	1414	1457	1544	1633	1672
1131	1151	1177	1274	1341	1408		1137	1215	1251	1298	1371	1414	1457	1544	1633	1672
1183	1204	1233	1336	1408	1478		1190	1274	1311	1361	1439	1486	1530	1627	1723	1762
1183	1204	1233	1336	1408	1478		1190	1274	1311	1361	1439	1486	1530	1627	1723	1762
1183	1204	1233	1336	1408	1478		1190	1274	1311	1361	1439	1486	1530	1627	1723	1762
1234	1256	1286	1396	1474	1549		1242	1332	1368	1424	1507	1556	1604	1705	1809	1853
1234	1256	1286	1396	1474	1549		1242	1332	1368	1424	1507	1556	1604	1705	1809	1853
1234	1256	1286	1396	1474	1549		1242	1332	1368	1424	1507	1556	1604	1705	1809	1853
1302	1324	1357	1474	1553	1634		1309	1404	1444	1501	1591	1643	1695	1803	1911	1957
1302	1324	1357	1474	1553	1634		1309	1404	1444	1501	1591	1643	1695	1803	1911	1957
1302	1324	1357	1474	1553	1634		1309	1404	1444	1501	1591	1643	1695	1803	1911	1957
1366	1391	1426	1550	1634	1723		1374	1475	1519	1580	1674	1728	1784	1897	2013	2061
1366	1391	1426	1550	1634	1723		1374	1475	1519	1580	1674	1728	1784	1897	2013	2061
1366	1391	1426	1550	1634	1723		1374	1475	1519	1580	1674	1728	1784	1897	2013	2061
1409	1436	1470	1602	1694	1784		1416	1522	1569	1634	1733	1791	1848	1969	2089	2142
1409	1436	1470	1602	1694	1784		1416	1522	1569	1634	1733	1791	1848	1969	2089	2142
1409	1436	1470	1602	1694	1784		1416	1522	1569	1634	1733	1791	1848	1969	2089	2142
1448	1476	1516	1652	1749	1843		1459	1569	1619	1687	1791	1853	1914	2040	2166	2221
1448	1476	1516	1652	1749	1843		1459	1569	1619	1687	1791	1853	1914	2040	2166	2221
1448	1476	1516	1652	1749	1843		1459	1569	1619	1687	1791	1853	1914	2040	2166	2221
1536	1564	1603	1749	1846	1948		1543	1660	1711	1784	1892	1957	2022	2154	2287	2344
1536	1564	1603	1749	1846	1948		1543	1660	1711	1784	1892	1957	2022	2154	2287	2344
1536	1564	1603	1749	1846	1948		1543	1660	1711	1784	1892	1957	2022	2154	2287	2344
1619	1649	1689	1841	1946	2052		1627	1751	1805	1879	1994	2061	2129	2267	2407	2468
1619	1649	1689	1841	1946	2052		1627	1751	1805	1879	1994	2061	2129	2267	2407	2468
1619	1649	1689	1841	1946	2052		1627	1751	1805	1879	1994	2061	2129	2267	2407	2468
1671	1702	1746	1904	2013	2123		1680	1809	1863	1944	2062	2132	2205	2349	2495	2558
1671	1702	1746	1904	2013	2123		1680	1809	1863	1944	2062	2132	2205	2349	2495	2558
1671	1702	1746	1904	2013	2123		1680	1809	1863	1944	2062	2132	2205	2349	2495	2558
1721	1754	1800	1965	2079	2193		1731	1865	1921	2006	2130	2205	2276	2428	2581	2645
1721	1754	1800	1965	2079	2193		1731	1865	1921	2006	2130	2205	2276	2428	2581	2645
1721	1754	1800	1965	2079	2193		1731	1865	1921	2006	2130	2205	2276	2428	2581	2645
1756	1791	1837	2003	2122	2237		1767	1904	1964	2046	2175	2246	2321	2474	2630	2697
1792	1829	1876	2051	2173	2291		1805	1945	2008	2095	2227	2303	2380	2541	2702	2771
1792	1829	1876	2051	2173	2291		1805	1945	2008	2095	2227	2303	2380	2541	2702	2771

If Accent/Mica Hardware Finish is specified for depth 36" - 42", add 11  
If Accent/Mica Hardware Finish is specified for depth 43" - 71", add 24

Pricing is continued on the following page.

**G X D U**  
**Infinity Desk Edge Screen**  
**(Continued)**

**DIMENSIONS**  
**INCHES / MM**

H	W
42 / 1067	36 / 914
42 / 1067	37 / 940
42 / 1067	38 / 965
42 / 1067	39 / 991
42 / 1067	40 / 1016
42 / 1067	41 / 1041
42 / 1067	42 / 1067
42 / 1067	43 / 1092
42 / 1067	44 / 1118
42 / 1067	45 / 1143
42 / 1067	46 / 1168
42 / 1067	47 / 1194
42 / 1067	48 / 1219
42 / 1067	49 / 1245
42 / 1067	50 / 1270
42 / 1067	51 / 1295
42 / 1067	52 / 1321
42 / 1067	53 / 1346
42 / 1067	54 / 1372
42 / 1067	55 / 1397
42 / 1067	56 / 1422
42 / 1067	57 / 1448
42 / 1067	58 / 1473
42 / 1067	59 / 1499
42 / 1067	60 / 1524
42 / 1067	61 / 1549
42 / 1067	62 / 1575
42 / 1067	63 / 1600
42 / 1067	64 / 1626
42 / 1067	65 / 1651
42 / 1067	66 / 1676
42 / 1067	67 / 1702
42 / 1067	68 / 1727
42 / 1067	69 / 1753
42 / 1067	70 / 1778
42 / 1067	71 / 1803

**PRICING**

MODESTY HEIGHT (M)															
NO WIRE MANAGER (N)															
PANEL FABRIC						UPHOLSTERY FABRIC									
COM/ Gr. A	Gr. 1	Gr. 2	Gr. 3	Gr. 4	Gr. 5	COM/ Gr. 1	Gr. 2	Gr. 3	Gr. 4	Gr. 5	Gr. 6	Gr. 7	Gr. 8	Gr. 9	Gr. 10
1124	1143	1168	1258	1324	1387	1129	1204	1235	1282	1353	1393	1434	1517	1602	1637
1124	1143	1168	1262	1328	1393	1129	1205	1237	1286	1357	1398	1440	1527	1614	1651
1124	1143	1170	1264	1333	1398	1129	1206	1242	1288	1363	1406	1447	1537	1626	1662
1175	1196	1223	1320	1389	1459	1182	1262	1296	1347	1419	1466	1509	1599	1689	1728
1175	1196	1225	1324	1394	1466	1181	1263	1299	1349	1426	1470	1516	1607	1702	1741
1175	1196	1225	1328	1398	1470	1181	1264	1303	1354	1431	1476	1522	1619	1712	1754
1226	1249	1276	1384	1455	1528	1233	1317	1356	1409	1489	1537	1581	1679	1778	1817
1226	1249	1279	1386	1460	1536	1233	1318	1358	1411	1494	1542	1590	1688	1787	1830
1226	1249	1279	1388	1466	1540	1233	1323	1359	1416	1498	1547	1597	1697	1800	1843
1293	1315	1347	1460	1538	1615	1299	1391	1431	1487	1572	1622	1672	1776	1879	1921
1293	1315	1347	1463	1542	1621	1299	1393	1434	1491	1575	1628	1679	1784	1890	1936
1293	1315	1348	1466	1546	1627	1299	1394	1436	1494	1581	1633	1685	1793	1903	1948
1358	1384	1416	1537	1619	1701	1366	1464	1506	1566	1655	1707	1761	1870	1981	2027
1358	1384	1416	1539	1622	1707	1365	1466	1509	1569	1659	1714	1767	1881	1994	2041
1358	1384	1417	1542	1627	1712	1365	1467	1510	1572	1666	1721	1776	1889	2003	2052
1400	1426	1461	1589	1674	1762	1409	1512	1556	1620	1714	1768	1826	1942	2057	2107
1400	1426	1463	1591	1680	1767	1409	1513	1557	1622	1720	1778	1833	1950	2070	2122
1400	1426	1463	1594	1684	1776	1408	1514	1561	1627	1725	1783	1840	1962	2080	2132
1440	1468	1506	1637	1731	1823	1448	1557	1604	1672	1771	1830	1889	2012	2133	2186
1440	1468	1506	1642	1734	1829	1448	1558	1605	1674	1778	1837	1896	2022	2147	2199
1440	1468	1507	1644	1738	1835	1448	1561	1609	1679	1783	1843	1906	2029	2156	2212
1526	1553	1594	1733	1830	1926	1537	1649	1700	1767	1873	1936	1998	2126	2255	2312
1526	1553	1594	1735	1835	1935	1536	1650	1701	1773	1879	1942	2006	2134	2267	2325
1526	1553	1596	1738	1839	1939	1536	1652	1703	1776	1885	1948	2013	2147	2277	2336
1609	1641	1680	1828	1930	2029	1620	1738	1788	1865	1973	2040	2104	2239	2375	2432
1609	1641	1681	1830	1935	2036	1620	1740	1792	1867	1980	2046	2114	2250	2388	2446
1609	1641	1681	1833	1938	2043	1619	1741	1794	1870	1983	2052	2120	2258	2397	2458
1660	1694	1735	1889	1996	2102	1672	1797	1850	1928	2043	2112	2180	2321	2462	2523
1660	1694	1735	1891	1999	2107	1672	1799	1854	1932	2049	2119	2186	2330	2473	2537
1660	1694	1735	1895	2003	2115	1672	1800	1855	1936	2054	2124	2194	2340	2486	2548
1711	1746	1788	1949	2061	2175	1724	1854	1909	1991	2112	2182	2254	2401	2549	2613
1711	1746	1788	1951	2064	2179	1723	1855	1912	1994	2117	2189	2260	2410	2561	2623
1711	1746	1791	1956	2071	2184	1723	1856	1914	1997	2122	2194	2269	2420	2574	2638
1749	1783	1829	1996	2114	2228	1758	1895	1953	2039	2164	2238	2313	2468	2621	2689
1785	1818	1867	2036	2154	2272	1797	1935	1995	2079	2207	2283	2359	2514	2671	2736
1785	1818	1867	2040	2159	2277	1794	1936	1996	2082	2212	2288	2365	2523	2682	2750

If Accent/Mica Hardware Finish is specified for depth 36" - 42", add 11  
 If Accent/Mica Hardware Finish is specified for depth 43" - 71", add 24

Pricing is continued on the following page.

## G X D U

### Infinity Desk Edge Screen (Continued)

#### DIMENSIONS INCHES / MM

H	W
51 / 1295	36 / 914
51 / 1295	37 / 940
51 / 1295	38 / 965
51 / 1295	39 / 991
51 / 1295	40 / 1016
51 / 1295	41 / 1041
51 / 1295	42 / 1067
51 / 1295	43 / 1092
51 / 1295	44 / 1118
51 / 1295	45 / 1143
51 / 1295	46 / 1168
51 / 1295	47 / 1194
51 / 1295	48 / 1219
51 / 1295	49 / 1245
51 / 1295	50 / 1270
51 / 1295	51 / 1295
51 / 1295	52 / 1321
51 / 1295	53 / 1346
51 / 1295	54 / 1372
51 / 1295	55 / 1397
51 / 1295	56 / 1422
51 / 1295	57 / 1448
51 / 1295	58 / 1473
51 / 1295	59 / 1499
51 / 1295	60 / 1524
51 / 1295	61 / 1549
51 / 1295	62 / 1575
51 / 1295	63 / 1600
51 / 1295	64 / 1626
51 / 1295	65 / 1651
51 / 1295	66 / 1676
51 / 1295	67 / 1702
51 / 1295	68 / 1727
51 / 1295	69 / 1753
51 / 1295	70 / 1778
51 / 1295	71 / 1803

#### PRICING

MODESTY HEIGHT (M) (CONTINUED)															
NO WIRE MANAGER (N) (CONTINUED)															
PANEL FABRIC							UPHOLSTERY FABRIC								
COM/ Gr. A	Gr. 1	Gr. 2	Gr. 3	Gr. 4	Gr. 5	COM/ Gr. 1	Gr. 2	Gr. 3	Gr. 4	Gr. 5	Gr. 6	Gr. 7	Gr. 8	Gr. 9	Gr. 10
1347	1368	1398	1506	1580	1654	1355	1440	1477	1531	1614	1660	1709	1809	1907	1949
1347	1368	1398	1510	1583	1660	1355	1444	1480	1538	1620	1670	1719	1817	1920	1965
1346	1368	1400	1513	1591	1670	1354	1445	1485	1542	1626	1675	1726	1830	1935	1978
1404	1426	1459	1573	1654	1733	1410	1504	1544	1602	1689	1740	1792	1899	2003	2051
1402	1426	1460	1577	1658	1740	1410	1506	1547	1605	1696	1749	1802	1909	2019	2064
1402	1426	1460	1580	1663	1749	1409	1509	1550	1610	1702	1755	1810	1920	2031	2079
1460	1485	1519	1642	1727	1813	1467	1568	1610	1673	1764	1818	1876	1989	2102	2152
1459	1485	1519	1645	1732	1818	1467	1569	1614	1677	1773	1829	1884	1999	2117	2166
1459	1485	1520	1649	1737	1828	1467	1570	1618	1681	1779	1836	1891	2012	2130	2180
1517	1544	1580	1711	1805	1895	1526	1633	1680	1746	1844	1904	1962	2082	2205	2255
1517	1544	1581	1715	1809	1903	1526	1634	1681	1750	1850	1911	1969	2094	2217	2270
1517	1544	1581	1720	1814	1909	1526	1635	1684	1754	1858	1918	1978	2103	2230	2284
1574	1603	1643	1783	1879	1975	1583	1697	1748	1816	1921	1983	2046	2176	2303	2359
1574	1603	1643	1785	1884	1982	1582	1700	1750	1820	1928	1992	2055	2185	2315	2371
1574	1603	1644	1787	1889	1991	1582	1702	1753	1826	1935	1998	2063	2196	2330	2388
1624	1654	1695	1843	1945	2048	1633	1754	1806	1879	1992	2056	2123	2258	2394	2454
1624	1654	1696	1845	1949	2055	1633	1755	1809	1884	1997	2063	2130	2269	2407	2468
1622	1654	1696	1848	1956	2062	1632	1756	1811	1888	2002	2071	2138	2280	2421	2483
1672	1703	1748	1903	2010	2119	1681	1809	1863	1941	2057	2126	2196	2340	2484	2546
1672	1703	1748	1906	2014	2125	1681	1810	1866	1945	2063	2133	2206	2350	2496	2560
1671	1703	1749	1909	2021	2131	1680	1811	1867	1949	2071	2142	2213	2363	2511	2575
1873	1907	1950	2116	2229	2342	1884	2016	2073	2155	2280	2351	2426	2576	2727	2792
1871	1907	1951	2119	2235	2349	1884	2019	2076	2160	2285	2360	2434	2588	2741	2805
1871	1907	1951	2123	2239	2357	1884	2021	2079	2164	2290	2367	2442	2599	2755	2822
2074	2109	2156	2329	2449	2567	2086	2224	2285	2371	2501	2578	2654	2812	2971	3038
2073	2109	2159	2333	2454	2575	2086	2227	2288	2377	2509	2586	2664	2824	2983	3052
2073	2109	2159	2336	2458	2581	2086	2229	2290	2380	2514	2592	2671	2833	2998	3067
2126	2164	2214	2394	2519	2643	2140	2285	2349	2439	2575	2654	2734	2900	3066	3137
2126	2164	2214	2396	2523	2650	2138	2287	2351	2442	2581	2664	2743	2912	3079	3150
2126	2164	2216	2401	2529	2657	2138	2288	2356	2448	2588	2669	2751	2921	3094	3165
2180	2220	2272	2458	2590	2720	2193	2345	2410	2507	2648	2732	2815	2988	3162	3233
2180	2220	2273	2462	2593	2727	2193	2348	2413	2511	2653	2737	2824	2999	3173	3249
2180	2220	2273	2466	2600	2734	2192	2349	2418	2515	2660	2745	2832	3010	3189	3262
2223	2265	2318	2514	2650	2787	2237	2395	2465	2562	2711	2797	2885	3066	3246	3324
2267	2307	2363	2561	2698	2835	2280	2441	2511	2611	2760	2849	2936	3119	3302	3381
2266	2307	2364	2563	2703	2843	2277	2442	2514	2614	2765	2855	2945	3131	3316	3396

If Accent/Mica Hardware Finish is specified for depth 36" - 42", add 14  
 If Accent/Mica Hardware Finish is specified for depth 43" - 71", add 29

Pricing is continued on the following page.



**G X D U**  
**Infinity Desk Edge Screen**  
**(Continued)**

**DIMENSIONS**  
**INCHES / MM**

H	W
57 / 1448	36 / 914
57 / 1448	37 / 940
57 / 1448	38 / 965
57 / 1448	39 / 991
57 / 1448	40 / 1016
57 / 1448	41 / 1041
57 / 1448	42 / 1067
57 / 1448	43 / 1092
57 / 1448	44 / 1118
57 / 1448	45 / 1143
57 / 1448	46 / 1168
57 / 1448	47 / 1194
57 / 1448	48 / 1219
57 / 1448	49 / 1245
57 / 1448	50 / 1270
57 / 1448	51 / 1295
57 / 1448	52 / 1321
57 / 1448	53 / 1346
57 / 1448	54 / 1372
57 / 1448	55 / 1397
57 / 1448	56 / 1422
57 / 1448	57 / 1448
57 / 1448	58 / 1473
57 / 1448	59 / 1499
57 / 1448	60 / 1524
57 / 1448	61 / 1549
57 / 1448	62 / 1575
57 / 1448	63 / 1600
57 / 1448	64 / 1626
57 / 1448	65 / 1651
57 / 1448	66 / 1676
57 / 1448	67 / 1702
57 / 1448	68 / 1727
57 / 1448	69 / 1753
57 / 1448	70 / 1778
57 / 1448	71 / 1803

**PRICING**

MODESTY HEIGHT (M) (CONTINUED)															
NO WIRE MANAGER (N) (CONTINUED)															
PANEL FABRIC						UPHOLSTERY FABRIC									
COM/ Gr. A	Gr. 1	Gr. 2	Gr. 3	Gr. 4	Gr. 5	COM/ Gr. 1	Gr. 2	Gr. 3	Gr. 4	Gr. 5	Gr. 6	Gr. 7	Gr. 8	Gr. 9	Gr. 10
1417	1440	1471	1583	1662	1740	1424	1517	1556	1614	1697	1749	1799	1903	2006	2051
1417	1440	1471	1583	1662	1740	1424	1517	1556	1614	1697	1749	1799	1903	2006	2051
1417	1440	1471	1583	1662	1740	1424	1517	1556	1614	1697	1749	1799	1903	2006	2051
1494	1519	1551	1673	1756	1840	1500	1600	1643	1703	1793	1846	1903	2013	2124	2173
1494	1519	1551	1673	1756	1840	1500	1600	1643	1703	1793	1846	1903	2013	2124	2173
1494	1519	1551	1673	1756	1840	1500	1600	1643	1703	1793	1846	1903	2013	2124	2173
1569	1596	1630	1758	1848	1938	1577	1681	1727	1792	1889	1946	2002	2123	2240	2290
1569	1596	1630	1758	1848	1938	1577	1681	1727	1792	1889	1946	2002	2123	2240	2290
1569	1596	1630	1758	1848	1938	1577	1681	1727	1792	1889	1946	2002	2123	2240	2290
1622	1650	1687	1824	1919	2014	1630	1741	1788	1859	1964	2024	2084	2209	2336	2390
1622	1650	1687	1824	1919	2014	1630	1741	1788	1859	1964	2024	2084	2209	2336	2390
1622	1650	1687	1824	1919	2014	1630	1741	1788	1859	1964	2024	2084	2209	2336	2390
1675	1704	1746	1889	1991	2092	1684	1803	1854	1926	2035	2100	2164	2298	2431	2487
1675	1704	1746	1889	1991	2092	1684	1803	1854	1926	2035	2100	2164	2298	2431	2487
1675	1704	1746	1889	1991	2092	1684	1803	1854	1926	2035	2100	2164	2298	2431	2487
1735	1767	1810	1964	2070	2177	1748	1870	1925	2001	2117	2184	2253	2394	2534	2594
1735	1767	1810	1964	2070	2177	1748	1870	1925	2001	2117	2184	2253	2394	2534	2594
1735	1767	1810	1964	2070	2177	1748	1870	1925	2001	2117	2184	2253	2394	2534	2594
1799	1832	1876	2039	2149	2259	1809	1939	1996	2077	2199	2270	2342	2490	2639	2702
1799	1832	1876	2039	2149	2259	1809	1939	1996	2077	2199	2270	2342	2490	2639	2702
1799	1832	1876	2039	2149	2259	1809	1939	1996	2077	2199	2270	2342	2490	2639	2702
2012	2046	2093	2261	2379	2496	2024	2160	2220	2305	2431	2509	2583	2737	2894	2960
2012	2046	2093	2261	2379	2496	2024	2160	2220	2305	2431	2509	2583	2737	2894	2960
2012	2046	2093	2261	2379	2496	2024	2160	2220	2305	2431	2509	2583	2737	2894	2960
2224	2260	2310	2487	2611	2733	2237	2380	2442	2532	2666	2744	2823	2985	3149	3219
2224	2260	2310	2487	2611	2733	2237	2380	2442	2532	2666	2744	2823	2985	3149	3219
2224	2260	2310	2487	2611	2733	2237	2380	2442	2532	2666	2744	2823	2985	3149	3219
2277	2315	2367	2552	2681	2808	2289	2440	2507	2599	2737	2822	2903	3072	3245	3316
2277	2315	2367	2552	2681	2808	2289	2440	2507	2599	2737	2822	2903	3072	3245	3316
2277	2315	2367	2552	2681	2808	2289	2440	2507	2599	2737	2822	2903	3072	3245	3316
2330	2368	2423	2615	2750	2884	2342	2499	2567	2666	2810	2895	2982	3161	3337	3413
2330	2368	2423	2615	2750	2884	2342	2499	2567	2666	2810	2895	2982	3161	3337	3413
2330	2368	2423	2615	2750	2884	2342	2499	2567	2666	2810	2895	2982	3161	3337	3413
2378	2419	2472	2668	2804	2940	2391	2549	2619	2717	2865	2952	3040	3221	3402	3480
2424	2466	2522	2726	2868	3010	2437	2604	2674	2777	2930	3020	3112	3301	3488	3569
2424	2466	2522	2726	2868	3010	2437	2604	2674	2777	2930	3020	3112	3301	3488	3569

If Accent/Mica Hardware Finish is specified for depth 36" - 42", add 14  
If Accent/Mica Hardware Finish is specified for depth 43" - 71", add 29

Pricing is continued on the following page.

**G X D U**

**Infinity Desk Edge Screen  
(Continued)**

**DIMENSIONS  
INCHES / MM**

H	W
42 / 1067	36 / 914
42 / 1067	37 / 940
42 / 1067	38 / 965
42 / 1067	39 / 991
42 / 1067	40 / 1016
42 / 1067	41 / 1041
42 / 1067	42 / 1067
42 / 1067	43 / 1092
42 / 1067	44 / 1118
42 / 1067	45 / 1143
42 / 1067	46 / 1168
42 / 1067	47 / 1194
42 / 1067	48 / 1219
42 / 1067	49 / 1245
42 / 1067	50 / 1270
42 / 1067	51 / 1295
42 / 1067	52 / 1321
42 / 1067	53 / 1346
42 / 1067	54 / 1372
42 / 1067	55 / 1397
42 / 1067	56 / 1422
42 / 1067	57 / 1448
42 / 1067	58 / 1473
42 / 1067	59 / 1499
42 / 1067	60 / 1524
42 / 1067	61 / 1549
42 / 1067	62 / 1575
42 / 1067	63 / 1600
42 / 1067	64 / 1626
42 / 1067	65 / 1651
42 / 1067	66 / 1676
42 / 1067	67 / 1702
42 / 1067	68 / 1727
42 / 1067	69 / 1753
42 / 1067	70 / 1778
42 / 1067	71 / 1803

**PRICING**

MODESTY HEIGHT (M) (CONTINUED)															
WITH WIRE MANAGER (Y)															
PANEL FABRIC							UPHOLSTERY FABRIC								
COM/ Gr. A	Gr. 1	Gr. 2	Gr. 3	Gr. 4	Gr. 5	COM/ Gr. 1	Gr. 2	Gr. 3	Gr. 4	Gr. 5	Gr. 6	Gr. 7	Gr. 8	Gr. 9	Gr. 10
1131	1151	1176	1267	1333	1395	1137	1213	1244	1289	1359	1402	1441	1526	1610	1648
1131	1151	1176	1269	1336	1402	1137	1214	1249	1295	1365	1408	1448	1537	1622	1659
1131	1151	1177	1274	1341	1408	1137	1215	1251	1298	1371	1414	1457	1544	1633	1672
1183	1204	1232	1329	1398	1467	1191	1269	1305	1356	1430	1474	1517	1607	1700	1737
1183	1204	1233	1333	1404	1474	1190	1273	1309	1358	1436	1478	1524	1618	1710	1751
1183	1204	1233	1336	1408	1478	1190	1274	1311	1361	1439	1486	1530	1627	1723	1762
1234	1256	1285	1391	1464	1538	1242	1327	1364	1417	1497	1544	1591	1687	1785	1828
1234	1256	1286	1394	1468	1543	1242	1328	1366	1419	1501	1550	1598	1697	1797	1839
1234	1256	1286	1396	1474	1549	1242	1332	1368	1424	1507	1556	1604	1705	1809	1853
1302	1324	1356	1468	1546	1624	1309	1400	1439	1496	1580	1630	1680	1784	1888	1932
1302	1324	1356	1470	1550	1629	1309	1402	1441	1499	1583	1635	1687	1792	1899	1944
1302	1324	1357	1474	1553	1634	1309	1404	1444	1501	1591	1643	1695	1803	1911	1957
1366	1391	1424	1544	1627	1709	1376	1471	1514	1573	1663	1715	1768	1879	1991	2036
1366	1391	1424	1547	1630	1715	1374	1474	1517	1577	1670	1724	1778	1889	2001	2049
1366	1391	1426	1550	1634	1723	1374	1475	1519	1580	1674	1728	1784	1897	2013	2061
1409	1436	1469	1597	1682	1771	1417	1520	1566	1628	1724	1779	1835	1950	2067	2117
1409	1436	1470	1599	1688	1778	1417	1521	1567	1630	1727	1785	1841	1961	2077	2130
1409	1436	1470	1602	1694	1784	1416	1522	1569	1634	1733	1791	1848	1969	2089	2142
1448	1476	1514	1648	1738	1832	1459	1567	1614	1680	1780	1839	1897	2021	2144	2196
1448	1476	1514	1650	1742	1837	1459	1568	1615	1682	1785	1845	1906	2029	2154	2208
1448	1476	1516	1652	1749	1843	1459	1569	1619	1687	1791	1853	1914	2040	2166	2221
1536	1564	1602	1741	1839	1936	1544	1657	1707	1778	1883	1944	2008	2134	2265	2319
1536	1564	1602	1746	1843	1942	1543	1658	1709	1781	1888	1950	2014	2146	2275	2333
1536	1564	1603	1749	1846	1948	1543	1660	1711	1784	1892	1957	2022	2154	2287	2344
1619	1649	1688	1836	1938	2040	1628	1749	1799	1873	1982	2048	2115	2247	2382	2441
1619	1649	1689	1839	1942	2044	1628	1750	1802	1876	1989	2055	2122	2258	2395	2455
1619	1649	1689	1841	1946	2052	1627	1751	1805	1879	1994	2061	2129	2267	2407	2468
1671	1702	1746	1897	2003	2112	1680	1806	1859	1937	2052	2120	2189	2330	2471	2532
1671	1702	1746	1900	2009	2117	1680	1807	1861	1939	2057	2126	2196	2338	2484	2546
1671	1702	1746	1904	2013	2123	1680	1809	1863	1944	2062	2132	2205	2349	2495	2558
1721	1754	1799	1959	2070	2182	1732	1861	1918	1998	2120	2191	2261	2409	2559	2621
1721	1754	1799	1962	2073	2186	1731	1863	1920	2001	2125	2197	2270	2420	2570	2634
1721	1754	1800	1965	2079	2193	1731	1865	1921	2006	2130	2205	2276	2428	2581	2645
1756	1791	1837	2003	2122	2237	1767	1904	1964	2046	2175	2246	2321	2474	2630	2697
1793	1829	1876	2044	2163	2280	1806	1942	2002	2088	2214	2290	2366	2522	2680	2745
1793	1829	1876	2048	2167	2287	1805	1944	2003	2092	2221	2298	2374	2532	2691	2759

If Accent/Mica Hardware Finish is specified for depth 36" - 42", add 14  
 If Accent/Mica Hardware Finish is specified for depth 43" - 71", add 29

Pricing is continued on the following page.

**G X D U**  
**Infinity Desk Edge Screen**  
**(Continued)**

**DIMENSIONS**  
**INCHES / MM**

**PRICING**

DIMENSIONS		MODESTY HEIGHT (M) (CONTINUED)															
INCHES / MM		WITH WIRE MANAGER (Y) (CONTINUED)															
		PANEL FABRIC						UPHOLSTERY FABRIC									
H	W	COM/ Gr. A	Gr. 1	Gr. 2	Gr. 3	Gr. 4	Gr. 5	COM/ Gr. 1	Gr. 2	Gr. 3	Gr. 4	Gr. 5	Gr. 6	Gr. 7	Gr. 8	Gr. 9	Gr. 10
51 / 1295	36 / 914	1356	1378	1408	1514	1590	1662	1363	1448	1487	1542	1622	1671	1719	1816	1915	1959
51 / 1295	37 / 940	1356	1378	1408	1519	1594	1671	1363	1451	1490	1546	1628	1677	1726	1828	1930	1972
51 / 1295	38 / 965	1355	1378	1409	1521	1599	1677	1361	1453	1492	1550	1633	1684	1734	1839	1942	1988
51 / 1295	39 / 991	1411	1436	1467	1581	1662	1741	1418	1513	1552	1610	1700	1750	1802	1908	2013	2059
51 / 1295	40 / 1016	1410	1436	1468	1588	1667	1750	1418	1514	1556	1615	1704	1756	1810	1918	2027	2073
51 / 1295	41 / 1041	1410	1436	1468	1590	1673	1756	1417	1517	1558	1620	1710	1763	1817	1930	2041	2088
51 / 1295	42 / 1067	1468	1492	1527	1650	1735	1820	1475	1575	1620	1681	1775	1829	1885	1997	2112	2160
51 / 1295	43 / 1092	1467	1492	1527	1654	1740	1829	1475	1577	1622	1685	1781	1837	1891	2009	2125	2176
51 / 1295	44 / 1118	1467	1492	1528	1657	1748	1836	1475	1579	1626	1689	1786	1844	1900	2021	2138	2189
51 / 1295	45 / 1143	1526	1552	1590	1721	1813	1904	1536	1643	1688	1754	1854	1912	1969	2092	2212	2265
51 / 1295	46 / 1168	1526	1552	1591	1725	1816	1911	1536	1644	1689	1757	1859	1919	1978	2102	2227	2277
51 / 1295	47 / 1194	1526	1552	1591	1727	1823	1918	1536	1645	1694	1762	1866	1926	1988	2114	2239	2291
51 / 1295	48 / 1219	1582	1611	1651	1791	1888	1983	1594	1705	1755	1826	1932	1994	2055	2183	2312	2366
51 / 1295	49 / 1245	1582	1611	1651	1793	1891	1992	1592	1707	1757	1830	1937	1999	2063	2194	2326	2380
51 / 1295	50 / 1270	1582	1611	1652	1797	1897	1998	1592	1710	1761	1835	1942	2008	2072	2206	2338	2395
51 / 1295	51 / 1295	1632	1662	1703	1853	1953	2056	1643	1762	1814	1888	1999	2064	2131	2267	2403	2461
51 / 1295	52 / 1321	1632	1662	1704	1855	1959	2063	1643	1763	1816	1891	2006	2072	2138	2276	2416	2474
51 / 1295	53 / 1346	1630	1662	1704	1858	1965	2071	1642	1764	1818	1896	2012	2079	2148	2288	2430	2490
51 / 1295	54 / 1372	1680	1711	1755	1911	2019	2126	1689	1816	1871	1949	2067	2134	2206	2349	2492	2553
51 / 1295	55 / 1397	1680	1711	1755	1914	2024	2133	1689	1817	1875	1953	2072	2144	2213	2360	2504	2568
51 / 1295	56 / 1422	1679	1711	1756	1918	2028	2140	1688	1818	1876	1959	2079	2150	2222	2370	2519	2583
51 / 1295	57 / 1448	1883	1915	1961	2124	2238	2350	1891	2025	2082	2164	2288	2361	2434	2584	2735	2801
51 / 1295	58 / 1473	1881	1915	1962	2126	2243	2359	1891	2027	2086	2168	2296	2367	2442	2594	2748	2815
51 / 1295	59 / 1499	1881	1915	1962	2131	2247	2365	1891	2028	2088	2175	2300	2377	2453	2607	2763	2829
51 / 1295	60 / 1524	2084	2119	2166	2337	2457	2576	2094	2235	2296	2380	2511	2588	2665	2822	2980	3046
51 / 1295	61 / 1549	2082	2119	2167	2340	2461	2583	2094	2236	2298	2387	2516	2593	2671	2832	2992	3061
51 / 1295	62 / 1575	2082	2119	2167	2344	2468	2590	2094	2238	2300	2390	2522	2602	2680	2842	3007	3074
51 / 1295	63 / 1600	2134	2175	2223	2403	2528	2652	2149	2296	2359	2448	2583	2665	2743	2909	3073	3146
51 / 1295	64 / 1626	2134	2175	2223	2405	2532	2659	2148	2297	2361	2453	2590	2671	2751	2920	3088	3161
51 / 1295	65 / 1651	2134	2175	2224	2409	2538	2667	2148	2298	2364	2456	2594	2676	2760	2930	3101	3173
51 / 1295	66 / 1676	2189	2228	2280	2468	2599	2728	2202	2356	2420	2515	2655	2741	2824	2996	3170	3244
51 / 1295	67 / 1702	2189	2228	2282	2471	2604	2735	2202	2357	2423	2519	2664	2747	2832	3008	3181	3256
51 / 1295	68 / 1727	2189	2228	2282	2473	2608	2743	2200	2359	2426	2523	2669	2755	2841	3018	3196	3272
51 / 1295	69 / 1753	2232	2273	2328	2522	2659	2795	2245	2404	2472	2572	2720	2805	2894	3073	3254	3332
51 / 1295	70 / 1778	2275	2315	2370	2570	2706	2846	2288	2450	2519	2619	2769	2856	2945	3127	3311	3390
51 / 1295	71 / 1803	2274	2315	2371	2574	2712	2853	2287	2453	2522	2622	2774	2863	2954	3140	3325	3405

If Accent/Mica Hardware Finish is specified for depth 36" - 42", add 14

If Accent/Mica Hardware Finish is specified for depth 43" - 71", add 29

Pricing is continued on the following page.

**G X D U**

**Infinity Desk Edge Screen  
(Continued)**

**DIMENSIONS  
INCHES / MM**

**PRICING**

		MODESTY HEIGHT (M) (CONTINUED)															
		WITH WIRE MANAGER (Y) (CONTINUED)															
		PANEL FABRIC						UPHOLSTERY FABRIC									
H	W	COM/ Gr. A	Gr. 1	Gr. 2	Gr. 3	Gr. 4	Gr. 5	COM/ Gr. 1	Gr. 2	Gr. 3	Gr. 4	Gr. 5	Gr. 6	Gr. 7	Gr. 8	Gr. 9	Gr. 10
57 / 1448	36 / 914	1426	1448	1480	1594	1672	1750	1434	1526	1566	1622	1705	1756	1807	1911	2014	2059
57 / 1448	37 / 940	1426	1448	1480	1594	1672	1750	1434	1526	1566	1622	1705	1756	1807	1911	2014	2059
57 / 1448	38 / 965	1426	1448	1480	1594	1672	1750	1434	1526	1566	1622	1705	1756	1807	1911	2014	2059
57 / 1448	39 / 991	1501	1527	1561	1681	1764	1848	1510	1609	1651	1711	1803	1856	1911	2022	2132	2180
57 / 1448	40 / 1016	1501	1527	1561	1681	1764	1848	1510	1609	1651	1711	1803	1856	1911	2022	2132	2180
57 / 1448	41 / 1041	1501	1527	1561	1681	1764	1848	1510	1609	1651	1711	1803	1856	1911	2022	2132	2180
57 / 1448	42 / 1067	1577	1603	1641	1767	1858	1946	1588	1689	1735	1802	1897	1956	2012	2131	2250	2300
57 / 1448	43 / 1092	1577	1603	1641	1767	1858	1946	1588	1689	1735	1802	1897	1956	2012	2131	2250	2300
57 / 1448	44 / 1118	1577	1603	1641	1767	1858	1946	1588	1689	1735	1802	1897	1956	2012	2131	2250	2300
57 / 1448	45 / 1143	1630	1658	1696	1833	1928	2024	1641	1751	1799	1867	1971	2031	2093	2217	2344	2397
57 / 1448	46 / 1168	1630	1658	1696	1833	1928	2024	1641	1751	1799	1867	1971	2031	2093	2217	2344	2397
57 / 1448	47 / 1194	1630	1658	1696	1833	1928	2024	1641	1751	1799	1867	1971	2031	2093	2217	2344	2397
57 / 1448	48 / 1219	1684	1712	1754	1897	1998	2100	1694	1811	1861	1936	2043	2107	2175	2306	2440	2496
57 / 1448	49 / 1245	1684	1712	1754	1897	1998	2100	1694	1811	1861	1936	2043	2107	2175	2306	2440	2496
57 / 1448	50 / 1270	1684	1712	1754	1897	1998	2100	1694	1811	1861	1936	2043	2107	2175	2306	2440	2496
57 / 1448	51 / 1295	1746	1778	1817	1971	2077	2184	1755	1879	1935	2010	2125	2193	2260	2403	2545	2605
57 / 1448	52 / 1321	1746	1778	1817	1971	2077	2184	1755	1879	1935	2010	2125	2193	2260	2403	2545	2605
57 / 1448	53 / 1346	1746	1778	1817	1971	2077	2184	1755	1879	1935	2010	2125	2193	2260	2403	2545	2605
57 / 1448	54 / 1372	1807	1840	1885	2046	2156	2269	1816	1948	2003	2087	2208	2277	2350	2499	2648	2711
57 / 1448	55 / 1397	1807	1840	1885	2046	2156	2269	1816	1948	2003	2087	2208	2277	2350	2499	2648	2711
57 / 1448	56 / 1422	1807	1840	1885	2046	2156	2269	1816	1948	2003	2087	2208	2277	2350	2499	2648	2711
57 / 1448	57 / 1448	2021	2055	2101	2272	2389	2504	2031	2168	2228	2313	2440	2516	2591	2747	2903	2968
57 / 1448	58 / 1473	2021	2055	2101	2272	2389	2504	2031	2168	2228	2313	2440	2516	2591	2747	2903	2968
57 / 1448	59 / 1499	2021	2055	2101	2272	2389	2504	2031	2168	2228	2313	2440	2516	2591	2747	2903	2968
57 / 1448	60 / 1524	2235	2270	2318	2496	2619	2742	2245	2390	2453	2541	2673	2752	2830	2993	3158	3226
57 / 1448	61 / 1549	2235	2270	2318	2496	2619	2742	2245	2390	2453	2541	2673	2752	2830	2993	3158	3226
57 / 1448	62 / 1575	2235	2270	2318	2496	2619	2742	2245	2390	2453	2541	2673	2752	2830	2993	3158	3226
57 / 1448	63 / 1600	2287	2326	2377	2561	2690	2818	2299	2449	2515	2607	2747	2829	2912	3082	3253	3325
57 / 1448	64 / 1626	2287	2326	2377	2561	2690	2818	2299	2449	2515	2607	2747	2829	2912	3082	3253	3325
57 / 1448	65 / 1651	2287	2326	2377	2561	2690	2818	2299	2449	2515	2607	2747	2829	2912	3082	3253	3325
57 / 1448	66 / 1676	2338	2378	2431	2623	2759	2893	2350	2509	2576	2673	2820	2905	2990	3169	3347	3422
57 / 1448	67 / 1702	2338	2378	2431	2623	2759	2893	2350	2509	2576	2673	2820	2905	2990	3169	3347	3422
57 / 1448	68 / 1727	2338	2378	2431	2623	2759	2893	2350	2509	2576	2673	2820	2905	2990	3169	3347	3422
57 / 1448	69 / 1753	2388	2427	2483	2675	2813	2948	2400	2559	2627	2726	2875	2960	3048	3227	3408	3487
57 / 1448	70 / 1778	2432	2473	2531	2734	2878	3018	2446	2612	2683	2787	2938	3030	3120	3309	3496	3577
57 / 1448	71 / 1803	2432	2473	2531	2734	2878	3018	2446	2612	2683	2787	2938	3030	3120	3309	3496	3577

If Accent/Mica Hardware Finish is specified for depth 36" - 42", add 14

If Accent/Mica Hardware Finish is specified for depth 43" - 71", add 29



**G Q D U**  
**Quilted Infinity Desk Edge Screen**

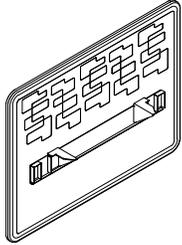

The Quilted fabrics provide a textured aesthetic, elevating the overall feel of an area creating a tactile user experience. Both the Teknion Quilted patterns Pico and Diode, designed by Suzanne Tick, soften the surface of textiles and elevate the user experience in the workplace with textured, quilted designs that add depth and perspective to a space. The Quilted Infinity Desk Edge Screen attaches to a worksurface to provide a lightweight, thin, upholstered fabric screen that is expressed in a softer curvilinear aesthetic that creates space division and local desktop privacy in varying levels.

**WHAT'S INCLUDED**

1 quilted infinity fabric desk edge screen, attachment brackets, wire manger (if specified).

**NOTES**

Infinity screen is 1/2" less than specified size. The worksurface wire gap is 1/2", to allow for mounting of select desk edge accessories.

Wire manger is designed to be accompanied by the Power Bar (YEPD) or Compact Power Bar (YEPS).

Fabric will be applied in the railroad direction in select Panel and Upholstery fabrics, refer to the *Teknion Textiles Program Guide*. The pattern thread is designed to accompany the color way of the fabric selected.

**PRODUCT OPTIONS**

Quilted Pattern	Modesty Height	Height	Width	Wire Manager	Screen Finish	Hardware Finish
<b>D</b> Diode	<b>S</b> Partial Modesty Height (23")	<b>42</b> 42" datum height	36 - 71	<b>Y</b> Yes	<b>Y</b> Panel Fabrics	Foundation
<b>P</b> Pico	<b>M</b> Modesty Height (15")	<b>51</b> 51" datum height		<b>N</b> No	<b>U</b> Upholstery Fabrics	Mica Accent

**SAMPLE ORDER CODE**

<b>GQDU P</b>	<b>S</b>	<b>42</b>	<b>60</b>	<b>Y</b>	<b>B204</b>	<b>74</b>
---------------	----------	-----------	-----------	----------	-------------	-----------

**DIMENSIONS**  
**INCHES / MM**

H	W
42 / 1067	36 / 914
42 / 1067	42 / 1067
42 / 1067	48 / 102
42 / 1067	54 / 1372
42 / 1067	60 / 1524
42 / 1067	66 / 1676
42 / 1067	72 / 1295
51 / 1295	36 / 914
51 / 1295	42 / 1067
51 / 1295	48 / 102
51 / 1295	54 / 1372
51 / 1295	60 / 1524
51 / 1295	66 / 1676
51 / 1295	72 / 1295

**PRICING**

**PARTIAL MODESTY HEIGHT (S)**

**NO WIRE MANAGER (N)**

**PANEL FABRIC**

COM/ Gr. A	Gr. 1	Gr. 2	Gr. 3	Gr. 4	Gr. 5
1098	1107	1124	1176	1214	1251
1198	1210	1227	1288	1333	1376
1304	1318	1338	1408	1457	1506
1400	1415	1437	1514	1569	1622
1561	1579	1603	1688	1749	1809
1634	1654	1680	1775	1840	1906
1723	1742	1771	1871	1941	2010
1416	1436	1461	1552	1618	1681
1564	1587	1615	1721	1794	1869
1732	1756	1788	1909	1994	2076
1859	1886	1925	2058	2152	2243
2082	2112	2153	2300	2403	2504
2222	2255	2300	2461	2575	2684
2343	2378	2426	2599	2719	2841

**UPHOLSTERY FABRIC**

COM/ Gr. 1	Gr. 2	Gr. 3	Gr. 4	Gr. 5	Gr. 6	Gr. 7	Gr. 8	Gr. 9	Gr. 10
1100	1144	1162	1191	1230	1255	1279	1328	1378	1398
1202	1252	1274	1305	1353	1379	1407	1463	1520	1544
1310	1365	1389	1426	1478	1509	1540	1603	1670	1696
1406	1468	1496	1536	1592	1627	1662	1733	1806	1836
1568	1635	1666	1710	1775	1814	1850	1930	2009	2043
1641	1717	1751	1797	1869	1911	1951	2040	2125	2161
1727	1810	1846	1897	1972	2016	2061	2155	2246	2288
1421	1497	1529	1575	1645	1687	1727	1813	1897	1935
1570	1658	1695	1749	1828	1875	1922	2019	2117	2160
1740	1837	1879	1939	2029	2085	2137	2247	2359	2405
1869	1978	2025	2092	2192	2252	2312	2434	2558	2611
2092	2212	2265	2338	2450	2514	2581	2715	2852	2912
2232	2364	2421	2502	2623	2696	2767	2915	3065	3128
2352	2495	2556	2642	2773	2850	2926	3087	3246	3314

If Accent/Mica Hardware Finish is specified for width 36" - 42", add 14  
 If Accent/Mica Hardware Finish is specified for depth 43" - 71", add 29

Pricing is continued on the following page.

# GXDU

## Infinity Desk Edge Screen (Continued)

**DIMENSIONS  
INCHES / MM**

H	W
42 / 1067	36 / 914
42 / 1067	42 / 1067
42 / 1067	48 / 102
42 / 1067	54 / 1372
42 / 1067	60 / 1524
42 / 1067	66 / 1676
42 / 1067	72 / 1295
51 / 1295	36 / 914
51 / 1295	42 / 1067
51 / 1295	48 / 102
51 / 1295	54 / 1372
51 / 1295	60 / 1524
51 / 1295	66 / 1676
51 / 1295	72 / 1295

**PRICING**

PARTIAL MODESTY HEIGHT (S) (CONTINUED)															
WITH WIRE MANAGER (Y)															
PANEL FABRIC							UPHOLSTERY FABRIC								
COM/ Gr. A	Gr. 1	Gr. 2	Gr. 3	Gr. 4	Gr. 5	COM/ Gr. 1	Gr. 2	Gr. 3	Gr. 4	Gr. 5	Gr. 6	Gr. 7	Gr. 8	Gr. 9	Gr. 10
1105	1115	1131	1185	1222	1258	1108	1152	1170	1198	1237	1263	1286	1336	1386	1407
1206	1219	1235	1297	1341	1384	1210	1259	1282	1313	1359	1387	1415	1470	1528	1552
1312	1327	1347	1416	1466	1513	1317	1374	1398	1434	1487	1517	1549	1611	1677	1704
1408	1422	1445	1522	1577	1630	1414	1476	1504	1543	1600	1634	1671	1741	1814	1844
1569	1588	1611	1696	1756	1816	1575	1644	1674	1719	1783	1822	1859	1938	2018	2052
1643	1662	1688	1783	1847	1914	1649	1725	1758	1806	1876	1919	1961	2048	2133	2168
1731	1751	1780	1879	1949	2019	1735	1817	1855	1906	1980	2025	2070	2163	2255	2297
1424	1444	1469	1561	1626	1689	1430	1506	1538	1583	1654	1695	1735	1820	1906	1942
1572	1594	1624	1728	1803	1876	1579	1666	1703	1756	1836	1884	1932	2027	2125	2167
1740	1764	1797	1918	2001	2085	1749	1845	1888	1948	2039	2093	2147	2257	2366	2413
1867	1895	1934	2067	2160	2252	1876	1987	2032	2100	2200	2259	2319	2442	2564	2619
2089	2120	2161	2308	2410	2514	2100	2220	2272	2347	2457	2522	2589	2725	2859	2920
2230	2265	2308	2470	2582	2694	2240	2371	2428	2511	2634	2703	2775	2924	3072	3137
2350	2388	2434	2607	2727	2849	2363	2502	2563	2650	2781	2857	2935	3095	3254	3323

MODESTY HEIGHT (M)															
NO WIRE MANAGER (N)															
PANEL FABRIC							UPHOLSTERY FABRIC								
COM/ Gr. A	Gr. 1	Gr. 2	Gr. 3	Gr. 4	Gr. 5	COM/ Gr. 1	Gr. 2	Gr. 3	Gr. 4	Gr. 5	Gr. 6	Gr. 7	Gr. 8	Gr. 9	Gr. 10
1409	1429	1455	1544	1609	1673	1415	1490	1521	1568	1637	1679	1720	1803	1888	1922
1557	1579	1607	1714	1785	1859	1564	1649	1687	1740	1818	1867	1912	2009	2107	2149
1732	1756	1788	1909	1992	2073	1740	1837	1877	1938	2028	2080	2133	2243	2356	2400
1859	1886	1922	2056	2149	2242	1867	1975	2024	2089	2190	2247	2307	2430	2552	2606
2080	2112	2152	2299	2401	2501	2092	2210	2260	2336	2446	2511	2577	2711	2848	2905
2228	2261	2306	2466	2578	2690	2240	2370	2426	2507	2629	2698	2771	2918	3066	3131
2350	2387	2432	2606	2725	2845	2361	2501	2561	2648	2777	2854	2930	3089	3248	3315
1844	1866	1896	2002	2077	2152	1853	1938	1975	2029	2112	2159	2207	2306	2404	2448
2032	2057	2092	2214	2300	2387	2040	2140	2183	2245	2337	2393	2450	2561	2674	2725
2227	2255	2296	2434	2531	2627	2237	2349	2398	2469	2575	2637	2698	2826	2955	3010
2395	2426	2470	2625	2734	2842	2404	2531	2586	2665	2780	2850	2920	3064	3207	3269
2878	2912	2959	3132	3251	3368	2887	3028	3088	3173	3304	3380	3457	3614	3773	3841
3057	3096	3148	3335	3466	3596	3070	3222	3286	3383	3523	3607	3692	3864	4038	4110
3224	3268	3323	3523	3664	3803	3239	3403	3472	3575	3726	3816	3905	4091	4278	4355

WITH WIRE MANAGER (Y)															
PANEL FABRIC							UPHOLSTERY FABRIC								
COM/ Gr. A	Gr. 1	Gr. 2	Gr. 3	Gr. 4	Gr. 5	COM/ Gr. 1	Gr. 2	Gr. 3	Gr. 4	Gr. 5	Gr. 6	Gr. 7	Gr. 8	Gr. 9	Gr. 10
1417	1437	1463	1552	1618	1681	1422	1498	1529	1575	1645	1687	1727	1811	1896	1932
1566	1588	1615	1723	1793	1867	1572	1657	1695	1749	1828	1875	1920	2018	2116	2156
1740	1764	1797	1918	1999	2082	1749	1845	1886	1946	2036	2088	2142	2252	2364	2408
1867	1895	1932	2063	2156	2250	1875	1982	2031	2099	2197	2257	2315	2439	2560	2613
2088	2120	2160	2307	2409	2510	2100	2217	2269	2344	2454	2519	2584	2719	2855	2913
2237	2270	2314	2473	2586	2698	2247	2378	2434	2515	2637	2706	2778	2926	3073	3139
2360	2394	2441	2613	2733	2853	2368	2510	2570	2655	2787	2862	2938	3097	3255	3324
1853	1874	1904	2010	2086	2160	1860	1946	1982	2039	2120	2166	2214	2314	2412	2455
2041	2064	2100	2222	2308	2394	2048	2149	2191	2254	2345	2400	2457	2570	2683	2733
2236	2265	2303	2442	2540	2636	2244	2359	2407	2477	2582	2644	2706	2834	2963	3018
2403	2434	2479	2635	2742	2850	2412	2540	2593	2672	2789	2857	2928	3071	3215	3276
2885	2920	2967	3140	3257	3377	2896	3036	3096	3181	3312	3389	3465	3622	3781	3849
3065	3103	3156	3344	3474	3605	3079	3230	3295	3391	3532	3615	3699	3872	4045	4120
3232	3275	3331	3532	3671	3811	3246	3410	3482	3582	3733	3824	3912	4098	4285	4366

If Accent/Mica Hardware Finish is specified for width 36" - 42", add 14  
 If Accent/Mica Hardware Finish is specified for depth 43" - 71", add 29

## G X S U

### Infinity Side Desk Edge Screen

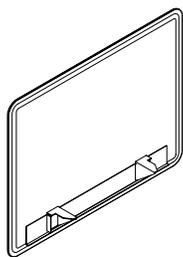

The Infinity Side Desk Edge Screen attaches to a worksurface to provide a lightweight, thin, upholstered fabric screen that is expressed in a softer curvilinear aesthetic that creates space division and local desktop privacy in varying levels.

#### WHAT'S INCLUDED

1 Infinity fabric side desk edge screen, attachment brackets.

#### NOTES

Infinity side screen is 1/2" less than specified size. Screen is designed to have no gap between worksurface and Side Screen.

Fabric will be applied in the railroad direction in select Panel and Upholstery fabrics, refer to the *Teknion Textiles Program Guide*.

#### PRODUCT OPTIONS

Modesty Base Height	Height	Depth	Screen Finish	Hardware Finish
<b>S</b> Partial Modesty Height	<b>42</b> for 42" high datum	17, 18, 23, 24, 29, 30, 31, 35, 36, 42, 48, 60, 72	Panel Fabrics Upholstery Fabrics	Foundation Mica Accent
<b>M</b> Modesty Height (15")	<b>51</b> for 51" high datum			
	<b>57</b> for 57" high datum			

#### SAMPLE ORDER CODE

<b>GXSU S</b>	<b>42</b>	<b>24</b>	<b>B204</b>	<b>74</b>
---------------	-----------	-----------	-------------	-----------

See Pricing on the following page.



G X S U

Infinity Side Desk Edge Screen  
(Continued)

DIMENSIONS  
INCHES / MM

PRICING

DIMENSIONS		PARTIAL MODESTY HEIGHT (S)															
		PANEL FABRIC						UPHOLSTERY FABRIC									
H	D	COM/ Gr. A	Gr. 1	Gr. 2	Gr. 3	Gr. 4	Gr. 5	COM/ Gr. 1	Gr. 2	Gr. 3	Gr. 4	Gr. 5	Gr. 6	Gr. 7	Gr. 8	Gr. 9	Gr. 10
42 / 1067	17 / 432	665	671	678	709	730	751	668	691	701	716	738	752	764	792	820	830
42 / 1067	18 / 457	665	671	678	709	730	751	668	691	701	716	738	752	764	792	820	830
42 / 1067	23 / 584	740	748	761	797	823	850	743	775	789	806	834	851	868	902	937	951
42 / 1067	24 / 610	740	748	761	797	823	850	743	775	789	806	834	851	868	902	937	951
42 / 1067	29 / 737	819	827	838	887	920	951	821	858	875	898	935	954	977	1019	1064	1080
42 / 1067	30 / 762	819	827	838	887	920	951	821	858	875	898	935	954	977	1019	1064	1080
42 / 1067	31 / 787	819	827	838	887	920	951	821	858	875	898	935	954	977	1019	1064	1080
42 / 1067	35 / 889	890	901	917	971	1008	1044	894	937	955	984	1023	1048	1071	1122	1172	1192
42 / 1067	36 / 762	890	901	917	971	1008	1044	894	937	955	984	1023	1048	1071	1122	1172	1192
42 / 1067	42 / 1067	969	980	997	1060	1102	1145	973	1022	1044	1075	1122	1150	1176	1233	1289	1315
42 / 1067	48 / 1219	1049	1065	1084	1153	1203	1251	1055	1112	1136	1172	1225	1255	1286	1349	1415	1441
42 / 1067	60 / 1524	1241	1257	1282	1366	1427	1487	1248	1315	1346	1388	1453	1492	1529	1609	1688	1723
42 / 1067	72 / 1829	1340	1359	1388	1490	1562	1632	1346	1430	1466	1516	1592	1637	1682	1779	1871	1912
51 / 1295	17 / 432	800	810	824	875	912	947	803	845	861	888	927	949	973	1018	1067	1085
51 / 1295	18 / 457	800	810	824	875	912	947	803	845	861	888	927	949	973	1018	1067	1085
51 / 1295	23 / 584	912	924	943	1007	1053	1098	916	967	991	1023	1072	1100	1129	1190	1250	1275
51 / 1295	24 / 610	912	924	943	1007	1053	1098	916	967	991	1023	1072	1100	1129	1190	1250	1275
51 / 1295	29 / 737	1021	1038	1060	1142	1197	1252	1024	1092	1121	1161	1222	1257	1294	1366	1441	1474
51 / 1295	30 / 762	1021	1038	1060	1142	1197	1252	1024	1092	1121	1161	1222	1257	1294	1366	1441	1474
51 / 1295	31 / 787	1021	1038	1060	1142	1197	1252	1024	1092	1121	1161	1222	1257	1294	1366	1441	1474
51 / 1295	35 / 889	1130	1150	1175	1267	1332	1395	1136	1211	1244	1289	1359	1402	1441	1527	1611	1649
51 / 1295	36 / 762	1130	1150	1175	1267	1332	1395	1136	1211	1244	1289	1359	1402	1441	1527	1611	1649
51 / 1295	42 / 1067	1234	1256	1286	1391	1466	1539	1242	1328	1365	1418	1498	1546	1594	1689	1787	1830
51 / 1295	48 / 1219	1365	1389	1422	1543	1627	1710	1374	1470	1513	1573	1663	1719	1771	1883	1992	2040
51 / 1295	60 / 1524	1624	1654	1695	1843	1945	2048	1633	1754	1806	1881	1992	2056	2123	2258	2394	2454
51 / 1295	72 / 1829	1800	1836	1885	2059	2182	2303	1811	1953	2016	2103	2236	2313	2393	2553	2715	2785
57 / 1448	17 / 432	830	843	856	907	947	980	834	879	897	921	961	982	1008	1054	1102	1124
57 / 1448	18 / 457	830	843	856	907	947	980	834	879	897	921	961	982	1008	1054	1102	1124
57 / 1448	23 / 584	961	975	993	1060	1107	1153	966	1019	1044	1076	1129	1157	1188	1249	1311	1338
57 / 1448	24 / 610	961	975	993	1060	1107	1153	966	1019	1044	1076	1129	1157	1188	1249	1311	1338
57 / 1448	29 / 737	1100	1118	1142	1227	1286	1343	1105	1175	1205	1249	1312	1349	1387	1464	1543	1575
57 / 1448	30 / 762	1100	1118	1142	1227	1286	1343	1105	1175	1205	1249	1312	1349	1387	1464	1543	1575
57 / 1448	31 / 787	1100	1118	1142	1227	1286	1343	1105	1175	1205	1249	1312	1349	1387	1464	1543	1575
57 / 1448	35 / 889	1124	1143	1170	1264	1333	1398	1129	1206	1242	1288	1363	1406	1447	1537	1626	1662
57 / 1448	36 / 762	1124	1143	1170	1264	1333	1398	1129	1206	1242	1288	1363	1406	1447	1537	1626	1662
57 / 1448	42 / 1067	1183	1204	1233	1336	1408	1478	1190	1274	1311	1361	1439	1486	1530	1627	1723	1762
57 / 1448	48 / 1219	1358	1384	1417	1542	1627	1712	1365	1467	1510	1572	1666	1721	1776	1889	2003	2052
57 / 1448	60 / 1524	1609	1641	1681	1833	1938	2043	1619	1741	1794	1870	1983	2052	2120	2258	2397	2458
57 / 1448	72 / 1829	1784	1818	1867	2042	2163	2284	1794	1937	1998	2087	2217	2296	2371	2532	2695	2762

If Accent/Mica Hardware Finish is specified for width 17" - 42", add 14  
If Accent/Mica Hardware Finish is specified for width 48" - 72", add 29

Pricing is continued on the following page.

G X S U

Infinity Side Desk Edge Screen  
(Continued)

DIMENSIONS  
INCHES / MM

H	D
42 / 1067	17 / 432
42 / 1067	18 / 457
42 / 1067	23 / 584
42 / 1067	24 / 610
42 / 1067	29 / 737
42 / 1067	30 / 762
42 / 1067	31 / 787
42 / 1067	35 / 889
42 / 1067	36 / 762
42 / 1067	42 / 1067
42 / 1067	48 / 1219
42 / 1067	60 / 1524
42 / 1067	72 / 1829
51 / 1295	17 / 432
51 / 1295	18 / 457
51 / 1295	23 / 584
51 / 1295	24 / 610
51 / 1295	29 / 737
51 / 1295	30 / 762
51 / 1295	31 / 787
51 / 1295	35 / 889
51 / 1295	36 / 762
51 / 1295	42 / 1067
51 / 1295	48 / 1219
51 / 1295	60 / 1524
51 / 1295	72 / 1829
57 / 1448	17 / 432
57 / 1448	18 / 457
57 / 1448	23 / 584
57 / 1448	24 / 610
57 / 1448	29 / 737
57 / 1448	30 / 762
57 / 1448	31 / 787
57 / 1448	35 / 889
57 / 1448	36 / 762
57 / 1448	42 / 1067
57 / 1448	48 / 1219
57 / 1448	60 / 1524
57 / 1448	72 / 1829

PRICING

MODESTY HEIGHT (M)															
PANEL FABRIC						UPHOLSTERY FABRIC									
COM/ Gr. A	Gr. 1	Gr. 2	Gr. 3	Gr. 4	Gr. 5	COM/ Gr. 1	Gr. 2	Gr. 3	Gr. 4	Gr. 5	Gr. 6	Gr. 7	Gr. 8	Gr. 9	Gr. 10
798	808	823	874	910	944	801	844	860	887	924	948	969	1015	1064	1083
798	808	823	874	910	944	801	844	860	887	924	948	969	1015	1064	1083
907	920	940	1003	1046	1092	912	963	986	1018	1068	1097	1124	1182	1242	1267
907	920	940	1003	1046	1092	912	963	986	1018	1068	1097	1124	1182	1242	1267
1016	1033	1055	1135	1191	1249	1022	1087	1115	1155	1215	1252	1287	1361	1436	1467
1016	1033	1055	1135	1191	1249	1022	1087	1115	1155	1215	1252	1287	1361	1436	1467
1016	1033	1055	1135	1191	1249	1022	1087	1115	1155	1215	1252	1287	1361	1436	1467
1124	1143	1168	1258	1324	1387	1129	1204	1235	1282	1353	1393	1434	1517	1602	1637
1124	1143	1168	1258	1324	1387	1129	1204	1235	1282	1353	1393	1434	1517	1602	1637
1226	1249	1276	1384	1455	1528	1233	1317	1356	1409	1489	1537	1581	1679	1778	1817
1226	1249	1276	1384	1455	1528	1233	1317	1356	1409	1489	1537	1581	1679	1778	1817
1358	1384	1416	1537	1619	1701	1366	1464	1506	1566	1655	1707	1761	1870	1981	2027
1358	1384	1416	1537	1619	1701	1366	1464	1506	1566	1655	1707	1761	1870	1981	2027
1609	1641	1680	1828	1930	2029	1620	1738	1788	1865	1973	2040	2104	2239	2375	2432
1609	1641	1680	1828	1930	2029	1620	1738	1788	1865	1973	2040	2104	2239	2375	2432
1784	1818	1867	2042	2163	2284	1794	1937	1998	2087	2217	2296	2371	2532	2695	2762
1784	1818	1867	2042	2163	2284	1794	1937	1998	2087	2217	2296	2371	2532	2695	2762
1022	1034	1051	1110	1151	1191	1027	1074	1095	1125	1170	1196	1222	1276	1332	1355
1022	1034	1051	1110	1151	1191	1027	1074	1095	1125	1170	1196	1222	1276	1332	1355
1131	1146	1168	1243	1295	1347	1136	1197	1225	1262	1317	1353	1385	1453	1522	1552
1131	1146	1168	1243	1295	1347	1136	1197	1225	1262	1317	1353	1385	1453	1522	1552
1241	1258	1285	1379	1445	1510	1248	1323	1356	1404	1474	1516	1557	1644	1731	1765
1241	1258	1285	1379	1445	1510	1248	1323	1356	1404	1474	1516	1557	1644	1731	1765
1241	1258	1285	1379	1445	1510	1248	1323	1356	1404	1474	1516	1557	1644	1731	1765
1347	1368	1398	1506	1580	1654	1355	1440	1477	1531	1614	1660	1709	1809	1907	1949
1347	1368	1398	1506	1580	1654	1355	1440	1477	1531	1614	1660	1709	1809	1907	1949
1460	1485	1519	1642	1727	1813	1467	1568	1610	1673	1764	1818	1876	1989	2102	2152
1460	1485	1519	1642	1727	1813	1467	1568	1610	1673	1764	1818	1876	1989	2102	2152
1574	1603	1643	1783	1879	1975	1583	1697	1748	1816	1921	1983	2046	2176	2303	2359
1574	1603	1643	1783	1879	1975	1583	1697	1748	1816	1921	1983	2046	2176	2303	2359
2074	2109	2156	2329	2449	2567	2086	2224	2285	2371	2501	2578	2654	2812	2971	3038
2074	2109	2156	2329	2449	2567	2086	2224	2285	2371	2501	2578	2654	2812	2971	3038
2266	2307	2364	2567	2710	2852	2277	2443	2516	2619	2772	2862	2954	3142	3330	3410
2266	2307	2364	2567	2710	2852	2277	2443	2516	2619	2772	2862	2954	3142	3330	3410
1053	1065	1083	1143	1185	1225	1058	1107	1129	1158	1204	1230	1257	1312	1368	1393
1053	1065	1083	1143	1185	1225	1058	1107	1129	1158	1204	1230	1257	1312	1368	1393
1181	1197	1220	1296	1349	1403	1188	1250	1279	1315	1374	1408	1441	1512	1583	1615
1181	1197	1220	1296	1349	1403	1188	1250	1279	1315	1374	1408	1441	1512	1583	1615
1318	1340	1366	1466	1534	1602	1327	1406	1440	1491	1564	1607	1651	1741	1832	1869
1318	1340	1366	1466	1534	1602	1327	1406	1440	1491	1564	1607	1651	1741	1832	1869
1318	1340	1366	1466	1534	1602	1327	1406	1440	1491	1564	1607	1651	1741	1832	1869
1445	1468	1499	1611	1690	1768	1455	1544	1582	1641	1726	1776	1826	1932	2033	2079
1445	1468	1499	1611	1690	1768	1455	1544	1582	1641	1726	1776	1826	1932	2033	2079
1569	1596	1630	1758	1848	1938	1577	1681	1727	1792	1889	1946	2002	2123	2240	2290
1569	1596	1630	1758	1848	1938	1577	1681	1727	1792	1889	1946	2002	2123	2240	2290
1675	1704	1746	1889	1991	2092	1684	1803	1854	1926	2035	2100	2164	2298	2431	2487
1675	1704	1746	1889	1991	2092	1684	1803	1854	1926	2035	2100	2164	2298	2431	2487
2224	2260	2310	2487	2611	2733	2237	2380	2442	2532	2666	2744	2823	2985	3149	3219
2224	2260	2310	2487	2611	2733	2237	2380	2442	2532	2666	2744	2823	2985	3149	3219
2424	2466	2522	2726	2868	3010	2437	2604	2674	2777	2930	3020	3112	3301	3488	3569
2424	2466	2522	2726	2868	3010	2437	2604	2674	2777	2930	3020	3112	3301	3488	3569

If Accent/Mica Hardware Finish is specified for width 17" - 42", add 14  
If Accent/Mica Hardware Finish is specified for width 48" - 72", add 29



## HTNF

### Framed Fabric Desk Edge Screen

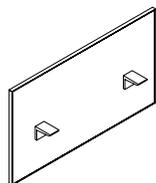

The Framed Fabric Desk Edge Screen attaches to the worksurface on to provide an upholstered fabric screen that is outlined by frame that creates space division and local desktop privacy in at various heights both above and below the worksurface.

#### WHAT'S INCLUDED

1 fabric desk edge screen, attachment brackets.

#### NOTES

Framed screens match the width of the worksurface for tight fit applications. Recommended to have 1/2" wire gap between screen and worksurface.

If Modesty base height option (F) is selected, then Height above worksurface option (22) is not available.

Fabric will be applied in the railroad direction in select Panel and Upholstery fabrics, refer to the *Teknion Textiles Program Guide*.

#### PRODUCT OPTIONS

Modesty Base Height	Height Above Worksurface	Width (in 1" increments)	Screen Finish	Metal Frame Finish
M Modesty Height (15")	13 for 42" high datum	36 - 72	Panel Fabric	Foundation
E Elevated Height (6")	22 for 51" high datum		Upholstery Fabric	Mica
F Floor Height (1")	28 for 57" high datum			Accent

#### SAMPLE ORDER CODE

<b>HTNF M</b>	<b>13</b>	<b>48</b>	<b>L308</b>	<b>74</b>
---------------	-----------	-----------	-------------	-----------

See Pricing on the following page.

## HTNF Fabric Desk Edge Screen (Continued)

**DIMENSIONS  
CODE / INCHES  
FOR MM X BY 25.4**

**PRICING**

		MODESTY HEIGHT (M)															
		PANEL FABRIC						UPHOLSTERY FABRIC									
H	W	COM/ Gr. A	Gr. 1	Gr. 2	Gr. 3	Gr. 4	Gr. 5	COM/ Gr. 1	Gr. 2	Gr. 3	Gr. 4	Gr. 5	Gr. 6	Gr. 7	Gr. 8	Gr. 9	Gr. 10
42	36-38	985	1004	1031	1127	1195	1259	991	1069	1102	1151	1225	1266	1310	1396	1487	1524
42	39-41	1064	1083	1112	1215	1286	1358	1069	1152	1190	1241	1317	1364	1410	1506	1600	1642
42	42-44	1138	1161	1191	1303	1379	1453	1146	1235	1274	1329	1411	1461	1510	1610	1712	1756
42	45-47	1161	1183	1218	1334	1415	1496	1168	1263	1304	1363	1449	1501	1553	1662	1771	1816
42	48-50	1181	1205	1241	1364	1448	1537	1189	1288	1333	1394	1489	1543	1598	1711	1828	1875
42	51-53	1251	1276	1312	1444	1536	1626	1257	1364	1410	1476	1574	1632	1689	1811	1932	1982
42	54-56	1318	1347	1386	1522	1619	1712	1328	1439	1489	1557	1660	1723	1784	1909	2036	2092
42	57-59	1336	1365	1407	1550	1650	1751	1346	1464	1514	1588	1696	1758	1824	1957	2089	2148
42	60-62	1354	1384	1424	1575	1681	1786	1361	1486	1539	1614	1727	1794	1863	2001	2142	2202
42	63-65	1408	1439	1483	1642	1751	1860	1417	1546	1600	1681	1800	1870	1941	2087	2232	2296
42	66-68	1461	1494	1540	1704	1818	1935	1470	1604	1662	1748	1870	1944	2018	2168	2321	2388
42	69	1477	1513	1558	1726	1843	1959	1490	1626	1684	1767	1895	1968	2043	2197	2351	2419
42	70-72	1494	1529	1577	1753	1873	1995	1506	1648	1709	1797	1928	2003	2082	2243	2404	2471
51	36-38	1095	1118	1150	1262	1340	1417	1101	1195	1233	1289	1374	1424	1475	1579	1682	1727
51	39-41	1172	1196	1228	1349	1434	1517	1177	1279	1318	1380	1470	1524	1579	1689	1802	1848
51	42-44	1248	1273	1309	1437	1526	1615	1255	1358	1406	1469	1567	1624	1680	1800	1918	1968
51	45-47	1267	1295	1333	1469	1566	1659	1276	1387	1436	1504	1607	1670	1728	1855	1981	2035
51	48-50	1287	1316	1357	1500	1602	1703	1296	1415	1466	1539	1648	1711	1778	1909	2043	2100
51	51-53	1380	1411	1453	1605	1712	1818	1389	1514	1569	1645	1761	1829	1896	2039	2179	2239
51	54-56	1471	1506	1550	1711	1823	1935	1483	1614	1671	1753	1873	1944	2016	2164	2313	2377
51	57-59	1489	1522	1569	1738	1856	1972	1499	1635	1696	1781	1908	1983	2059	2214	2370	2437
51	60-62	1504	1540	1590	1765	1889	2012	1516	1659	1723	1811	1944	2024	2101	2265	2428	2498
51	63-65	1569	1605	1658	1843	1971	2100	1580	1731	1797	1889	2028	2112	2193	2364	2534	2607
51	66-68	1633	1673	1726	1919	2054	2186	1645	1803	1870	1968	2115	2199	2285	2462	2642	2717
51	69	1651	1693	1748	1941	2077	2213	1663	1823	1891	1991	2138	2224	2313	2493	2673	2751
51	70-72	1667	1709	1764	1968	2112	2253	1680	1845	1918	2021	2175	2265	2356	2545	2732	2812
57	36-38	1213	1235	1267	1380	1459	1537	1221	1312	1353	1409	1492	1543	1594	1697	1802	1845
57	39-41	1312	1336	1369	1491	1574	1658	1318	1418	1461	1521	1611	1666	1721	1832	1942	1991
57	42-44	1410	1437	1471	1600	1689	1780	1418	1522	1569	1633	1731	1787	1844	1965	2082	2132
57	45-47	1433	1460	1497	1633	1728	1824	1440	1551	1599	1670	1773	1833	1892	2019	2147	2199
57	48-50	1453	1483	1522	1667	1767	1869	1463	1580	1630	1704	1813	1877	1942	2074	2209	2266
57	51-53	1546	1577	1620	1773	1879	1987	1556	1680	1734	1811	1926	1995	2062	2205	2344	2405
57	54-56	1641	1673	1719	1879	1991	2101	1650	1781	1837	1919	2041	2112	2183	2333	2481	2545
57	57-59	1655	1689	1735	1907	2024	2140	1667	1805	1863	1948	2074	2152	2227	2381	2538	2605
57	60-62	1672	1707	1756	1935	2056	2179	1682	1828	1889	1978	2112	2191	2269	2431	2594	2666
57	63-65	1749	1785	1837	2022	2150	2277	1758	1909	1975	2069	2208	2289	2371	2543	2714	2787
57	66-68	1823	1861	1915	2107	2243	2377	1835	1992	2059	2156	2303	2389	2473	2652	2830	2906
57	69	1840	1881	1936	2130	2267	2403	1854	2012	2080	2179	2328	2413	2501	2682	2862	2940
57	70-72	1856	1897	1953	2156	2300	2441	1869	2035	2106	2209	2363	2454	2545	2733	2920	3000

If Accent/Mica Hardware Finish is specified for 36" - 41", add 14  
 If Accent/Mica Hardware Finish is specified for 42" - 72", add 29

Pricing is continued on the following page.

**H T N F**

**Framed Fabric Desk Edge Screen  
(Continued)**

**DIMENSIONS  
CODE / INCHES  
FOR MM X BY 25.4**

**PRICING**

		ELEVATED HEIGHT (E)															
		PANEL FABRIC					UPHOLSTERY FABRIC										
H	W	COM/ Gr. A	Gr. 1	Gr. 2	Gr. 3	Gr. 4	Gr. 5	COM/ Gr. 1	Gr. 2	Gr. 3	Gr. 4	Gr. 5	Gr. 6	Gr. 7	Gr. 8	Gr. 9	Gr. 10
42	36-38	1099	1122	1153	1266	1343	1421	1105	1198	1236	1295	1379	1430	1478	1582	1687	1732
42	39-41	1175	1200	1233	1355	1438	1521	1182	1282	1324	1385	1475	1528	1582	1695	1806	1854
42	42-44	1251	1276	1312	1440	1529	1620	1258	1363	1409	1474	1570	1628	1684	1805	1921	1972
42	45-47	1273	1299	1336	1474	1569	1663	1281	1391	1439	1509	1611	1673	1733	1859	1987	2040
42	48-50	1293	1320	1361	1506	1605	1707	1302	1418	1469	1543	1651	1715	1781	1914	2048	2103
42	51-53	1385	1416	1459	1610	1719	1824	1394	1519	1573	1650	1764	1833	1900	2042	2183	2244
42	54-56	1477	1512	1556	1719	1829	1939	1489	1620	1675	1757	1879	1949	2022	2170	2318	2381
42	57-59	1494	1528	1574	1746	1861	1978	1506	1643	1702	1786	1914	1991	2064	2221	2377	2442
42	60-62	1509	1544	1594	1771	1892	2016	1520	1663	1726	1815	1948	2027	2104	2269	2432	2501
42	63-65	1573	1610	1662	1846	1975	2103	1583	1734	1802	1892	2033	2116	2197	2367	2540	2612
42	66-68	1637	1677	1731	1922	2057	2192	1650	1807	1875	1972	2119	2205	2289	2468	2645	2721
42	69	1655	1696	1751	1945	2082	2217	1670	1828	1896	1995	2144	2229	2317	2498	2676	2756
42	70-72	1672	1712	1768	1972	2116	2257	1684	1850	1921	2025	2178	2269	2360	2548	2735	2817
51	36-38	1213	1235	1267	1380	1459	1537	1221	1312	1353	1409	1492	1543	1594	1697	1802	1845
51	39-41	1312	1336	1369	1491	1574	1658	1318	1418	1461	1521	1611	1666	1721	1832	1942	1991
51	42-44	1410	1437	1471	1600	1689	1780	1418	1522	1569	1633	1731	1787	1844	1965	2082	2132
51	45-47	1433	1460	1497	1633	1728	1824	1440	1551	1599	1670	1773	1833	1892	2019	2147	2199
51	48-50	1453	1483	1522	1667	1767	1869	1463	1580	1630	1704	1813	1877	1942	2074	2209	2266
51	51-53	1546	1577	1620	1773	1879	1987	1556	1680	1734	1811	1926	1995	2062	2205	2344	2405
51	54-56	1641	1673	1719	1879	1991	2101	1650	1781	1837	1919	2041	2112	2183	2333	2481	2545
51	57-59	1655	1689	1735	1907	2024	2140	1667	1805	1863	1948	2074	2152	2227	2381	2538	2605
51	60-62	1672	1707	1756	1935	2056	2179	1682	1828	1889	1978	2112	2191	2269	2431	2594	2666
51	63-65	1749	1785	1837	2022	2150	2277	1758	1909	1975	2069	2208	2289	2371	2543	2714	2787
51	66-68	1823	1861	1915	2107	2243	2377	1835	1992	2059	2156	2303	2389	2473	2652	2830	2906
51	69	1840	1881	1936	2130	2267	2403	1854	2012	2080	2179	2328	2413	2501	2682	2862	2940
51	70-72	1856	1897	1953	2156	2300	2441	1869	2035	2106	2209	2363	2454	2545	2733	2920	3000
		FLOOR HEIGHT (F)															
		PANEL FABRIC					UPHOLSTERY FABRIC										
H	W	COM/ Gr. A	Gr. 1	Gr. 2	Gr. 3	Gr. 4	Gr. 5	COM/ Gr. 1	Gr. 2	Gr. 3	Gr. 4	Gr. 5	Gr. 6	Gr. 7	Gr. 8	Gr. 9	Gr. 10
42	36-38	1200	1223	1255	1366	1445	1522	1206	1299	1338	1395	1478	1529	1580	1684	1787	1833
42	39-41	1302	1326	1358	1478	1564	1648	1309	1408	1448	1510	1600	1654	1709	1818	1932	1978
42	42-44	1400	1426	1463	1591	1680	1768	1409	1513	1558	1624	1721	1779	1835	1953	2072	2123
42	45-47	1421	1448	1487	1624	1720	1814	1431	1542	1590	1658	1762	1823	1884	2009	2134	2189
42	48-50	1444	1471	1513	1657	1757	1859	1451	1570	1621	1695	1803	1867	1934	2064	2199	2255
42	51-53	1537	1568	1609	1762	1869	1975	1546	1671	1725	1802	1916	1983	2052	2193	2335	2395
42	54-56	1629	1662	1707	1869	1980	2092	1641	1771	1828	1909	2029	2101	2175	2321	2470	2533
42	57-59	1645	1680	1726	1896	2013	2130	1657	1793	1854	1938	2064	2142	2216	2371	2528	2593
42	60-62	1660	1697	1748	1922	2046	2168	1673	1816	1879	1968	2101	2180	2258	2421	2586	2654
42	63-65	1737	1776	1828	2012	2140	2269	1750	1899	1966	2057	2197	2280	2363	2532	2703	2775
42	66-68	1813	1853	1906	2099	2232	2366	1824	1981	2049	2148	2291	2378	2465	2642	2822	2895
42	69	1830	1870	1925	2120	2257	2393	1843	2001	2071	2168	2317	2404	2492	2672	2853	2930
42	70-72	1845	1888	1944	2148	2289	2431	1859	2025	2097	2199	2351	2442	2533	2722	2910	2990

If Accent/Mica Hardware Finish is specified for 36" - 41", add 14

If Accent/Mica Hardware Finish is specified for 42" - 72", add 29



## GYSU

### Framed Fabric Side Desk Edge Screen

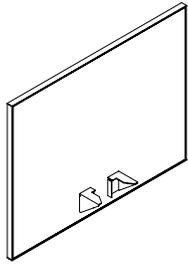

The Framed Fabric Side Desk Edge Screen attaches to the worksurface on to provide an upholstered fabric screen that is outlined by frame that creates space division and local desktop privacy in at various heights both above and below the worksurface.

#### WHAT'S INCLUDED

1 framed fabric desk edge screen, attachment brackets, corner connection hardware (if specified).

#### NOTES

Framed screens match the width of the worksurface for tight fit applications.

Fabric will be applied in the railroad direction in select Panel and Upholstery fabrics, refer to the *Teknion Textiles Program Guide*.

#### PRODUCT OPTIONS

Modesty Base Height	Height	Depth	Corner Connection	Screen Finish	Hardware Finish
<b>S</b> Partial Modesty Height	42 for 42" high datum	17, 18, 23, 24, 29, 30, 31, 35, 36, 42, 48	<b>N</b> No <b>R</b> Right <b>L</b> Left	Panel Fabrics Upholstery Fabrics	Foundation Mica Accent
<b>M</b> Modesty Height (15")	51 for 51" high datum				

#### SAMPLE ORDER CODE

<b>GYSU S</b>	<b>42</b>	<b>24</b>	<b>R</b>	<b>B204</b>	<b>74</b>
---------------	-----------	-----------	----------	-------------	-----------

#### DIMENSIONS INCHES / MM

H	D
42 / 1067	17 / 432
42 / 1067	18 / 457
42 / 1067	23 / 584
42 / 1067	24 / 610
42 / 1067	29 / 737
42 / 1067	30 / 762
42 / 1067	31 / 787
42 / 1067	35 / 889
42 / 1067	36 / 914
42 / 1067	42 / 1067
42 / 1067	48 / 1219
51 / 1295	17 / 432
51 / 1295	18 / 457
51 / 1295	23 / 584
51 / 1295	24 / 610
51 / 1295	29 / 737
51 / 1295	30 / 762
51 / 1295	31 / 787
51 / 1295	35 / 889
51 / 1295	36 / 914
51 / 1295	42 / 1067
51 / 1295	48 / 1219

#### PRICING

PARTIAL MODESTY HEIGHT (S)																
NO CORNER CONNECTION (N)																
PANEL FABRIC							UPHOLSTERY FABRIC									
COM/							COM/									
Gr. A	Gr. 1	Gr. 2	Gr. 3	Gr. 4	Gr. 5		Gr. 1	Gr. 2	Gr. 3	Gr. 4	Gr. 5	Gr. 6	Gr. 7	Gr. 8	Gr. 9	Gr. 10
619	625	635	663	681	701		623	646	655	670	691	703	715	740	767	778
619	625	635	665	685	705		623	646	656	672	694	707	718	746	775	787
681	690	700	736	762	787		685	713	728	745	771	790	805	837	871	886
681	690	701	738	764	791		685	715	729	746	776	792	808	844	879	891
743	753	766	810	841	871		746	783	798	821	854	874	894	935	975	992
743	753	766	812	844	875		746	785	800	823	858	879	898	941	981	1000
743	753	766	814	846	879		746	785	801	824	860	882	902	947	989	1007
797	807	822	875	912	948		800	844	861	888	927	950	974	1022	1070	1092
797	807	823	876	914	950		800	844	861	889	929	954	978	1028	1076	1099
891	904	921	984	1027	1069		895	947	967	1000	1045	1072	1100	1157	1214	1237
917	932	951	1021	1070	1118		922	979	1004	1039	1092	1122	1153	1218	1282	1310
700	709	725	770	806	838		703	741	761	785	821	843	863	910	952	973
700	709	725	775	810	845		702	743	762	789	827	849	871	917	965	985
823	836	854	916	959	1003		828	879	901	932	979	1007	1034	1092	1150	1174
823	836	856	918	965	1010		828	881	902	936	985	1012	1041	1101	1161	1188
932	948	969	1045	1098	1151		937	1000	1024	1065	1122	1155	1190	1258	1329	1359
932	948	969	1048	1101	1157		937	1002	1028	1068	1127	1162	1197	1268	1341	1371
932	948	971	1051	1107	1162		936	1003	1031	1071	1131	1168	1204	1279	1354	1385
985	1004	1030	1120	1181	1243		992	1065	1097	1143	1210	1250	1288	1373	1455	1491
985	1004	1030	1122	1185	1251		991	1067	1099	1145	1214	1256	1296	1381	1467	1501
1138	1161	1191	1296	1369	1444		1146	1233	1269	1324	1404	1449	1498	1596	1694	1734
1181	1205	1237	1358	1441	1526		1190	1286	1328	1388	1478	1531	1588	1697	1807	1855

If Accent/Mica Hardware Finish is specified for depth 17" - 42", add 14  
If Accent/Mica Hardware Finish is specified for depth 48", add 29

Pricing is continued on the following page.



GYSU

Framed Fabric Side Desk Edge Screen (Continued)

DIMENSIONS  
INCHES / MM

PRICING

**PARTIAL MODESTY HEIGHT (S) (CONTINUED)**

LEFT/RIGHT CORNER CONNECTION (L/R)

DIMENSIONS		PANEL FABRIC					UPHOLSTERY FABRIC										
H	D	COM/ Gr. A	Gr. 1	Gr. 2	Gr. 3	Gr. 4	Gr. 5	COM/ Gr. 1	Gr. 2	Gr. 3	Gr. 4	Gr. 5	Gr. 6	Gr. 7	Gr. 8	Gr. 9	Gr. 10
42 / 1067	17 / 432	633	638	646	673	694	711	635	657	666	680	702	715	728	753	778	791
42 / 1067	18 / 457	633	638	646	676	698	716	635	657	668	684	705	717	731	760	787	797
42 / 1067	23 / 584	694	701	710	746	771	797	698	726	738	758	785	800	817	850	883	897
42 / 1067	24 / 610	694	701	711	751	776	801	698	728	739	760	789	803	821	856	889	904
42 / 1067	29 / 737	756	764	777	822	853	883	760	794	810	831	864	886	906	947	986	1004
42 / 1067	30 / 762	756	764	777	823	856	887	760	796	812	834	869	889	911	951	993	1011
42 / 1067	31 / 787	756	764	777	824	858	889	760	796	814	836	872	891	914	958	1002	1018
42 / 1067	35 / 889	808	820	833	887	922	959	812	856	874	899	940	962	985	1034	1082	1102
42 / 1067	36 / 914	808	820	834	888	925	962	812	856	874	901	942	966	989	1040	1090	1110
42 / 1067	42 / 1067	904	916	934	995	1039	1080	907	958	979	1011	1057	1084	1112	1168	1226	1251
42 / 1067	48 / 1219	928	943	963	1033	1082	1129	935	991	1015	1049	1102	1133	1165	1228	1294	1320
51 / 1295	17 / 432	715	726	739	789	822	856	718	760	776	800	836	858	881	924	969	988
51 / 1295	18 / 457	715	726	739	791	827	860	717	761	777	803	843	863	887	934	980	1002
51 / 1295	23 / 584	838	853	869	932	975	1018	844	894	917	948	995	1022	1049	1107	1165	1190
51 / 1295	24 / 610	838	853	871	935	980	1024	844	895	918	951	1002	1028	1057	1118	1176	1203
51 / 1295	29 / 737	948	963	985	1061	1113	1166	952	1015	1041	1080	1137	1172	1205	1275	1346	1376
51 / 1295	30 / 762	948	963	985	1065	1118	1173	952	1016	1044	1083	1143	1177	1213	1285	1357	1387
51 / 1295	31 / 787	948	963	986	1068	1124	1177	951	1018	1046	1087	1148	1183	1221	1294	1368	1400
51 / 1295	35 / 889	1002	1019	1045	1135	1197	1258	1008	1080	1112	1158	1226	1264	1305	1388	1470	1507
51 / 1295	36 / 914	1002	1019	1045	1137	1202	1266	1007	1082	1115	1161	1230	1273	1312	1396	1483	1519
51 / 1295	42 / 1067	1155	1176	1206	1312	1386	1460	1162	1250	1286	1340	1418	1467	1514	1610	1709	1751
51 / 1295	48 / 1219	1197	1222	1255	1374	1459	1542	1205	1303	1343	1406	1496	1549	1602	1712	1823	1870

**MODESTY HEIGHT (M)**

NO CORNER CONNECTION (N)

DIMENSIONS		PANEL FABRIC					UPHOLSTERY FABRIC										
H	D	COM/ Gr. A	Gr. 1	Gr. 2	Gr. 3	Gr. 4	Gr. 5	COM/ Gr. 1	Gr. 2	Gr. 3	Gr. 4	Gr. 5	Gr. 6	Gr. 7	Gr. 8	Gr. 9	Gr. 10
42 / 1067	17 / 432	701	709	725	770	805	837	703	741	761	783	821	841	861	907	951	971
42 / 1067	18 / 457	700	709	725	775	808	845	702	743	762	789	824	849	869	916	963	984
42 / 1067	23 / 584	824	836	854	916	959	1003	828	879	899	932	978	1005	1033	1091	1148	1172
42 / 1067	24 / 610	823	836	856	918	963	1008	828	881	902	935	984	1012	1040	1099	1158	1183
42 / 1067	29 / 737	934	948	969	1044	1098	1150	937	1000	1024	1064	1121	1153	1189	1257	1327	1357
42 / 1067	30 / 762	932	948	969	1046	1101	1155	937	1002	1028	1068	1127	1161	1196	1266	1338	1369
42 / 1067	31 / 787	932	948	971	1049	1105	1162	937	1003	1030	1070	1130	1166	1203	1276	1349	1381
42 / 1067	35 / 889	986	1004	1028	1118	1180	1242	992	1065	1097	1142	1207	1249	1287	1369	1451	1489
42 / 1067	36 / 914	985	1004	1030	1121	1185	1250	991	1067	1098	1144	1213	1255	1295	1379	1464	1499
42 / 1067	42 / 1067	1138	1161	1190	1296	1368	1441	1146	1232	1268	1323	1402	1448	1496	1592	1689	1732
42 / 1067	48 / 1219	1181	1205	1237	1358	1440	1522	1190	1286	1328	1387	1477	1529	1582	1694	1805	1850
51 / 1295	17 / 432	853	863	881	936	975	1014	857	902	921	950	992	1018	1042	1095	1146	1170
51 / 1295	18 / 457	853	863	882	941	980	1021	857	904	924	954	1000	1024	1051	1105	1161	1183
51 / 1295	23 / 584	916	929	950	1022	1072	1124	920	979	1005	1041	1097	1128	1161	1227	1294	1323
51 / 1295	24 / 610	916	929	951	1027	1078	1130	920	980	1008	1045	1101	1135	1168	1236	1306	1336
51 / 1295	29 / 737	979	996	1021	1110	1172	1233	985	1057	1087	1131	1198	1237	1279	1358	1440	1475
51 / 1295	30 / 762	978	996	1022	1113	1176	1241	984	1058	1091	1136	1205	1248	1286	1369	1453	1490
51 / 1295	31 / 787	978	996	1022	1116	1182	1249	984	1060	1094	1142	1211	1253	1295	1381	1468	1504
51 / 1295	35 / 889	1097	1118	1146	1252	1324	1396	1102	1189	1226	1279	1357	1404	1448	1546	1643	1684
51 / 1295	36 / 914	1097	1118	1148	1255	1329	1404	1102	1190	1227	1282	1363	1410	1459	1557	1655	1700
51 / 1295	42 / 1067	1249	1273	1306	1430	1516	1600	1255	1356	1398	1461	1552	1607	1663	1778	1890	1939
51 / 1295	48 / 1219	1287	1316	1356	1496	1592	1688	1298	1410	1460	1529	1634	1697	1758	1888	2016	2071

If Accent/Mica Hardware Finish is specified for depth 17" - 42", add 14  
If Accent/Mica Hardware Finish is specified for depth 48", add 29

Pricing is continued on the following page.

**GYSU**

**Framed Fabric Side Desk Edge Screen (Continued)**

**DIMENSIONS  
INCHES / MM**

H	D
42 / 1067	17 / 432
42 / 1067	18 / 457
42 / 1067	23 / 584
42 / 1067	24 / 610
42 / 1067	29 / 737
42 / 1067	30 / 762
42 / 1067	31 / 787
42 / 1067	35 / 889
42 / 1067	36 / 914
42 / 1067	42 / 1067
42 / 1067	48 / 1219
51 / 1295	17 / 432
51 / 1295	18 / 457
51 / 1295	23 / 584
51 / 1295	24 / 610
51 / 1295	29 / 737
51 / 1295	30 / 762
51 / 1295	31 / 787
51 / 1295	35 / 889
51 / 1295	36 / 914
51 / 1295	42 / 1067
51 / 1295	48 / 1219

**PRICING**

MODESTY HEIGHT (M) (CONTINUED)															
LEFT/RIGHT CORNER CONNECTION (L/R)															
PANEL FABRIC							UPHOLSTERY FABRIC								
COM/ Gr. A	Gr. 1	Gr. 2	Gr. 3	Gr. 4	Gr. 5	COM/ Gr. 1	Gr. 2	Gr. 3	Gr. 4	Gr. 5	Gr. 6	Gr. 7	Gr. 8	Gr. 9	Gr. 10
716	726	739	789	821	854	718	760	776	798	836	857	879	922	967	986
715	726	739	791	824	860	717	761	777	803	841	863	886	932	979	1000
841	853	869	932	975	1018	844	894	916	948	993	1021	1048	1105	1163	1188
838	853	871	935	979	1023	844	895	918	950	1000	1028	1055	1115	1174	1200
949	963	985	1060	1113	1165	952	1015	1041	1078	1136	1170	1204	1274	1342	1373
948	963	985	1064	1118	1172	952	1016	1044	1083	1143	1176	1211	1282	1355	1386
948	963	986	1067	1122	1177	952	1018	1045	1085	1146	1182	1219	1293	1365	1396
1003	1019	1044	1133	1196	1257	1008	1080	1112	1157	1225	1263	1304	1386	1468	1504
1002	1019	1045	1136	1202	1264	1007	1082	1113	1160	1228	1269	1311	1394	1478	1516
1155	1176	1205	1312	1385	1459	1162	1249	1285	1338	1417	1466	1512	1607	1705	1749
1197	1222	1255	1374	1457	1539	1205	1303	1343	1404	1494	1546	1599	1709	1818	1866
869	882	897	952	992	1031	874	920	940	967	1010	1035	1060	1112	1163	1188
869	882	898	958	997	1039	874	921	942	973	1016	1042	1069	1124	1177	1202
934	948	967	1040	1091	1142	937	996	1022	1058	1113	1145	1177	1244	1311	1340
934	948	969	1044	1097	1148	937	997	1024	1064	1120	1152	1185	1255	1324	1355
996	1014	1039	1128	1189	1251	1003	1074	1104	1150	1215	1256	1295	1376	1459	1492
995	1014	1040	1130	1195	1257	1002	1075	1107	1153	1223	1263	1304	1387	1470	1507
995	1014	1040	1133	1200	1264	1002	1076	1110	1158	1228	1269	1312	1398	1486	1521
1113	1135	1163	1268	1341	1415	1121	1205	1243	1295	1374	1419	1467	1564	1659	1702
1113	1135	1165	1273	1347	1419	1121	1206	1244	1299	1380	1427	1475	1574	1673	1715
1264	1288	1324	1446	1531	1619	1273	1373	1416	1477	1570	1626	1681	1793	1908	1957
1305	1334	1373	1513	1609	1705	1315	1427	1476	1547	1652	1714	1778	1906	2033	2088

If Accent/Mica Hardware Finish is specified for depth 17" - 42", add 17

If Accent/Mica Hardware Finish is specified for depth 48", add 29



**G X F U**

**Infinity Desk Edge Floor Screen**

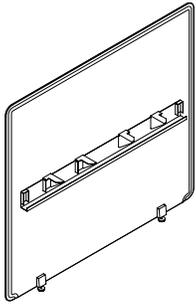

The Infinity Floor Desk Edge Screen attaches to a worksurface to provide a lightweight, thin, upholstered fabric screen that is expressed in a softer curvilinear aesthetic that creates space division and local desktop privacy down to the floor level.

**WHAT'S INCLUDED**

1 Infinity Floor fabric desk edge screen, attachment brackets, wire manager (if specified).

**NOTES**

Infinity Floor screen is 1/2" less than specified size. The worksurface wire gap is 1/2", to allow for mounting of select desk edge accessories.

Wire manager is designed to be accompanied by the Power Bar (YEPD) or Compact Power Bar (YEPS).

The screen is available in select Panel and Upholstery fabrics, refer to the *Teknion Textiles Program Guide*.

**PRODUCT OPTIONS**

Modesty Base Height	Height	Width (in 1" increments)	Screen Finish	Hardware Finish
F Floor Height (1")	42 for 42" high datum 51 for 51" high datum	36 - 70	Panel Fabrics Upholstery Fabrics	Foundation Mica Accent

**SAMPLE ORDER CODE**

<b>GXFU F</b>	<b>42</b>	<b>60</b>	<b>B204</b>	<b>74</b>
---------------	-----------	-----------	-------------	-----------

**DIMENSIONS  
INCHES / MM**

H	W
42 / 1067	36 / 914
42 / 1067	37 / 940
42 / 1067	38 / 965
42 / 1067	39 / 991
42 / 1067	40 / 1016
42 / 1067	41 / 1041
42 / 1067	42 / 1067
42 / 1067	43 / 1092
42 / 1067	44 / 1118
42 / 1067	45 / 1143
42 / 1067	46 / 1168
42 / 1067	47 / 1194
42 / 1067	48 / 1219
42 / 1067	49 / 1245
42 / 1067	50 / 1270
42 / 1067	51 / 1295
42 / 1067	52 / 1321
42 / 1067	53 / 1346
42 / 1067	54 / 1372
42 / 1067	55 / 1397
42 / 1067	56 / 1422

**PRICING**

**PANEL FABRIC**

COM/ Gr. A	Gr. 1	Gr. 2	Gr. 3	Gr. 4	Gr. 5
1550	1573	1604	1719	1794	1873
1550	1573	1604	1719	1794	1873
1550	1573	1604	1719	1794	1873
1610	1634	1670	1788	1873	1957
1610	1634	1670	1788	1873	1957
1610	1634	1670	1788	1873	1957
1672	1697	1733	1861	1950	2041
1672	1697	1733	1861	1950	2041
1672	1697	1733	1861	1950	2041
1731	1757	1794	1934	2027	2123
1731	1757	1794	1934	2027	2123
1731	1757	1794	1934	2027	2123
1731	1757	1794	1934	2027	2123
1788	1817	1859	2002	2103	2206
1788	1817	1859	2002	2103	2206
1788	1817	1859	2002	2103	2206
1840	1871	1914	2067	2175	2280
1840	1871	1914	2067	2175	2280
1840	1871	1914	2067	2175	2280
1891	1925	1969	2131	2243	2352
1891	1925	1969	2131	2243	2352
1891	1925	1969	2131	2243	2352

**UPHOLSTERY FABRIC**

COM/ Gr. 1	Gr. 2	Gr. 3	Gr. 4	Gr. 5	Gr. 6	Gr. 7	Gr. 8	Gr. 9	Gr. 10
1557	1650	1688	1748	1830	1881	1932	2035	2138	2183
1557	1650	1688	1748	1830	1881	1932	2035	2138	2183
1557	1650	1688	1748	1830	1881	1932	2035	2138	2183
1619	1719	1758	1818	1911	1965	2019	2130	2240	2288
1619	1719	1758	1818	1911	1965	2019	2130	2240	2288
1619	1719	1758	1818	1911	1965	2019	2130	2240	2288
1680	1784	1830	1895	1992	2049	2104	2224	2343	2394
1680	1784	1830	1895	1992	2049	2104	2224	2343	2394
1680	1784	1830	1895	1992	2049	2104	2224	2343	2394
1738	1850	1897	1967	2071	2131	2192	2317	2443	2498
1738	1850	1897	1967	2071	2131	2192	2317	2443	2498
1738	1850	1897	1967	2071	2131	2192	2317	2443	2498
1738	1850	1897	1967	2071	2131	2192	2317	2443	2498
1799	1916	1967	2041	2149	2213	2277	2410	2546	2602
1799	1916	1967	2041	2149	2213	2277	2410	2546	2602
1799	1916	1967	2041	2149	2213	2277	2410	2546	2602
1850	1973	2028	2104	2221	2288	2357	2498	2639	2699
1850	1973	2028	2104	2221	2288	2357	2498	2639	2699
1850	1973	2028	2104	2221	2288	2357	2498	2639	2699
1903	2033	2089	2173	2291	2364	2435	2584	2733	2796
1903	2033	2089	2173	2291	2364	2435	2584	2733	2796
1903	2033	2089	2173	2291	2364	2435	2584	2733	2796

If Accent/Mica Hardware Finish is specified for depth 36" - 42", add 14

If Accent/Mica Hardware Finish is specified for depth 43" - 70", add 29

Pricing is continued on the following page.

G X F U

Infinity Desk Edge Floor Screen  
(Continued)

DIMENSIONS  
INCHES / MM

PRICING

DIMENSIONS		PANEL FABRIC						UPHOLSTERY FABRIC									
H	W	COM/ Gr. A	Gr. 1	Gr. 2	Gr. 3	Gr. 4	Gr. 5	COM/ Gr. 1	Gr. 2	Gr. 3	Gr. 4	Gr. 5	Gr. 6	Gr. 7	Gr. 8	Gr. 9	Gr. 10
42 / 1067	57 / 1448	2129	2163	2209	2379	2496	2613	2140	2276	2336	2421	2548	2623	2699	2855	3011	3076
42 / 1067	58 / 1473	2129	2163	2209	2379	2496	2613	2140	2276	2336	2421	2548	2623	2699	2855	3011	3076
42 / 1067	59 / 1499	2129	2163	2209	2379	2496	2613	2140	2276	2336	2421	2548	2623	2699	2855	3011	3076
42 / 1067	60 / 1524	2364	2400	2449	2625	2748	2872	2375	2519	2581	2671	2803	2883	2960	3123	3286	3358
42 / 1067	61 / 1549	2364	2400	2449	2625	2748	2872	2375	2519	2581	2671	2803	2883	2960	3123	3286	3358
42 / 1067	62 / 1575	2364	2400	2449	2625	2748	2872	2375	2519	2581	2671	2803	2883	2960	3123	3286	3358
42 / 1067	63 / 1600	2421	2458	2511	2696	2824	2952	2432	2583	2649	2742	2882	2963	3045	3217	3388	3459
42 / 1067	64 / 1626	2421	2458	2511	2696	2824	2952	2432	2583	2649	2742	2882	2963	3045	3217	3388	3459
42 / 1067	65 / 1651	2421	2458	2511	2696	2824	2952	2432	2583	2649	2742	2882	2963	3045	3217	3388	3459
42 / 1067	66 / 1676	2477	2516	2570	2763	2896	3033	2488	2645	2714	2812	2958	3042	3128	3306	3486	3561
42 / 1067	67 / 1702	2477	2516	2570	2763	2896	3033	2488	2645	2714	2812	2958	3042	3128	3306	3486	3561
42 / 1067	68 / 1727	2477	2516	2570	2763	2896	3033	2488	2645	2714	2812	2958	3042	3128	3306	3486	3561
42 / 1067	69 / 1753	2522	2562	2618	2812	2948	3086	2534	2695	2763	2860	3010	3096	3183	3364	3545	3622
42 / 1067	70 / 1778	2568	2608	2665	2862	2999	3139	2581	2743	2812	2912	3061	3149	3238	3420	3603	3682
51 / 1295	36 / 914	1632	1655	1687	1800	1877	1956	1641	1732	1771	1829	1912	1964	2013	2117	2221	2266
51 / 1295	37 / 940	1632	1655	1687	1800	1877	1956	1641	1732	1771	1829	1912	1964	2013	2117	2221	2266
51 / 1295	38 / 965	1632	1655	1687	1800	1877	1956	1641	1732	1771	1829	1912	1964	2013	2117	2221	2266
51 / 1295	39 / 991	1710	1734	1767	1889	1972	2056	1719	1816	1859	1919	2010	2063	2119	2229	2340	2389
51 / 1295	40 / 1016	1710	1734	1767	1889	1972	2056	1719	1816	1859	1919	2010	2063	2119	2229	2340	2389
51 / 1295	41 / 1041	1710	1734	1767	1889	1972	2056	1719	1816	1859	1919	2010	2063	2119	2229	2340	2389
51 / 1295	42 / 1067	1787	1814	1850	1978	2069	2156	1797	1900	1946	2012	2107	2166	2222	2342	2460	2511
51 / 1295	43 / 1092	1787	1814	1850	1978	2069	2156	1797	1900	1946	2012	2107	2166	2222	2342	2460	2511
51 / 1295	44 / 1118	1787	1814	1850	1978	2069	2156	1797	1900	1946	2012	2107	2166	2222	2342	2460	2511
51 / 1295	45 / 1143	1844	1871	1909	2046	2142	2237	1854	1965	2012	2080	2184	2245	2306	2431	2559	2612
51 / 1295	46 / 1168	1844	1871	1909	2046	2142	2237	1854	1965	2012	2080	2184	2245	2306	2431	2559	2612
51 / 1295	47 / 1194	1844	1871	1909	2046	2142	2237	1854	1965	2012	2080	2184	2245	2306	2431	2559	2612
51 / 1295	48 / 1219	1899	1928	1968	2114	2213	2314	1908	2026	2076	2150	2258	2325	2389	2521	2654	2711
51 / 1295	49 / 1245	1899	1928	1968	2114	2213	2314	1908	2026	2076	2150	2258	2325	2389	2521	2654	2711
51 / 1295	50 / 1270	1899	1928	1968	2114	2213	2314	1908	2026	2076	2150	2258	2325	2389	2521	2654	2711
51 / 1295	51 / 1295	1965	1996	2039	2191	2298	2404	1973	2099	2153	2229	2344	2412	2481	2621	2763	2824
51 / 1295	52 / 1321	1965	1996	2039	2191	2298	2404	1973	2099	2153	2229	2344	2412	2481	2621	2763	2824
51 / 1295	53 / 1346	1965	1996	2039	2191	2298	2404	1973	2099	2153	2229	2344	2412	2481	2621	2763	2824
51 / 1295	54 / 1372	2029	2063	2107	2270	2380	2492	2041	2173	2228	2310	2431	2501	2575	2722	2872	2935
51 / 1295	55 / 1397	2029	2063	2107	2270	2380	2492	2041	2173	2228	2310	2431	2501	2575	2722	2872	2935
51 / 1295	56 / 1422	2029	2063	2107	2270	2380	2492	2041	2173	2228	2310	2431	2501	2575	2722	2872	2935
51 / 1295	57 / 1448	2277	2313	2360	2529	2645	2763	2289	2427	2486	2572	2698	2774	2850	3006	3162	3226
51 / 1295	58 / 1473	2277	2313	2360	2529	2645	2763	2289	2427	2486	2572	2698	2774	2850	3006	3162	3226
51 / 1295	59 / 1499	2277	2313	2360	2529	2645	2763	2289	2427	2486	2572	2698	2774	2850	3006	3162	3226
51 / 1295	60 / 1524	2526	2562	2612	2789	2912	3035	2538	2682	2744	2833	2966	3045	3123	3285	3452	3519
51 / 1295	61 / 1549	2526	2562	2612	2789	2912	3035	2538	2682	2744	2833	2966	3045	3123	3285	3452	3519
51 / 1295	62 / 1575	2526	2562	2612	2789	2912	3035	2538	2682	2744	2833	2966	3045	3123	3285	3452	3519
51 / 1295	63 / 1600	2581	2619	2671	2855	2983	3112	2592	2743	2808	2902	3041	3123	3206	3376	3547	3619
51 / 1295	64 / 1626	2581	2619	2671	2855	2983	3112	2592	2743	2808	2902	3041	3123	3206	3376	3547	3619
51 / 1295	65 / 1651	2581	2619	2671	2855	2983	3112	2592	2743	2808	2902	3041	3123	3206	3376	3547	3619
51 / 1295	66 / 1676	2637	2674	2728	2921	3057	3191	2648	2804	2873	2971	3117	3201	3286	3465	3644	3720
51 / 1295	67 / 1702	2637	2674	2728	2921	3057	3191	2648	2804	2873	2971	3117	3201	3286	3465	3644	3720
51 / 1295	68 / 1727	2637	2674	2728	2921	3057	3191	2648	2804	2873	2971	3117	3201	3286	3465	3644	3720
51 / 1295	69 / 1753	2689	2728	2782	2978	3116	3251	2701	2859	2929	3027	3176	3261	3350	3531	3711	3788
51 / 1295	70 / 1778	2742	2781	2835	3036	3172	3311	2755	2915	2985	3086	3233	3323	3410	3593	3776	3856

If Accent/Mica Hardware Finish is specified for depth 36" - 42", add 14  
If Accent/Mica Hardware Finish is specified for depth 43" - 70", add 29

**G X E U**

**Infinity Side Desk Edge Floor Screen**

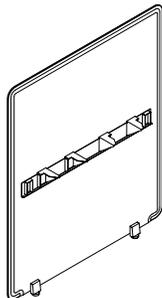

The Infinity Floor Side Desk Edge Screen attaches to a worksurface to provide a lightweight, thin, upholstered fabric screen that is expressed in a softer curvilinear aesthetic that creates space division and local desktop privacy down to the floor level.

**WHAT'S INCLUDED**

1 Infinity fabric side desk edge floor screen, attachment brackets.

**NOTES**

Infinity side floor screen is 1/2" less than specified size. Screen is designed to have no gap between worksurface and Side Screen.

Fabric will be applied in the railroad direction in select Panel and Upholstery fabrics, refer to the *Teknion Textiles Program Guide*.

**PRODUCT OPTIONS**

Modesty Base Height	Height	Depth	Screen Finish	Hardware Finish
F Floor Height (1")	42 for 42" high datum 51 for 51" high datum	23, 24, 29, 30, 35, 36, 42, 48, 60, 72	Panel Fabrics Upholstery Fabrics	Foundation Mica Accent

**SAMPLE ORDER CODE**

<b>GXEU F</b>	<b>42</b>	<b>24</b>	<b>B204</b>	<b>74</b>
---------------	-----------	-----------	-------------	-----------

**DIMENSIONS  
INCHES / MM**

H	D
42 / 1067	23 / 584
42 / 1067	24 / 610
42 / 1067	29 / 737
42 / 1067	30 / 762
42 / 1067	35 / 889
42 / 1067	36 / 762
42 / 1067	42 / 1067
42 / 1067	48 / 1219
42 / 1067	60 / 1524
42 / 1067	72 / 1829
51 / 1295	23 / 584
51 / 1295	24 / 610
51 / 1295	29 / 737
51 / 1295	30 / 762
51 / 1295	35 / 889
51 / 1295	36 / 762
51 / 1295	42 / 1067
51 / 1295	48 / 1219
51 / 1295	60 / 1524
51 / 1295	72 / 1829

**PRICING**

**PANEL FABRIC**

COM/ Gr. A	Gr. 1	Gr. 2	Gr. 3	Gr. 4	Gr. 5
1327	1341	1363	1438	1490	1542
1327	1341	1363	1438	1490	1542
1440	1460	1486	1575	1641	1703
1440	1460	1486	1575	1641	1703
1551	1573	1603	1710	1785	1859
1551	1573	1603	1710	1785	1859
1673	1697	1732	1855	1941	2026
1788	1817	1858	1997	2094	2191
2365	2400	2448	2619	2737	2856
2567	2608	2666	2868	3011	3151
1384	1396	1418	1494	1546	1598
1384	1396	1418	1494	1546	1598
1513	1530	1557	1649	1711	1776
1513	1530	1557	1649	1711	1776
1633	1655	1685	1792	1867	1941
1633	1655	1685	1792	1867	1941
1788	1814	1848	1971	2057	2144
1899	1928	1967	2106	2205	2300
2528	2562	2611	2781	2902	3019
2741	2781	2838	3041	3183	3325

**UPHOLSTERY FABRIC**

COM/ Gr. 1	Gr. 2	Gr. 3	Gr. 4	Gr. 5	Gr. 6	Gr. 7	Gr. 8	Gr. 9	Gr. 10
1332	1391	1418	1457	1513	1546	1579	1649	1719	1749
1332	1391	1418	1457	1513	1546	1579	1649	1719	1749
1446	1521	1552	1599	1670	1709	1750	1833	1916	1951
1446	1521	1552	1599	1670	1709	1750	1833	1916	1951
1558	1645	1682	1737	1817	1866	1914	2013	2112	2154
1558	1645	1682	1737	1817	1866	1914	2013	2112	2154
1680	1781	1824	1886	1978	2033	2089	2202	2315	2365
1800	1912	1962	2031	2137	2199	2260	2390	2517	2574
2375	2515	2576	2664	2792	2868	2945	3101	3260	3329
2579	2745	2818	2920	3072	3164	3254	3443	3631	3712
1387	1447	1475	1513	1569	1602	1634	1704	1775	1805
1387	1447	1475	1513	1569	1602	1634	1704	1775	1805
1519	1594	1626	1672	1740	1781	1820	1906	1989	2025
1519	1594	1626	1672	1740	1781	1820	1906	1989	2025
1642	1727	1764	1818	1900	1948	1996	2095	2193	2237
1642	1727	1764	1818	1900	1948	1996	2095	2193	2237
1797	1897	1941	2002	2095	2150	2207	2318	2432	2483
1909	2022	2071	2142	2246	2308	2370	2499	2627	2682
2538	2676	2737	2825	2955	3033	3109	3267	3425	3490
2752	2918	2990	3094	3246	3336	3428	3617	3804	3885

If Accent/Mica Hardware Finish is specified for width 23" - 42", add 14

If Accent/Mica Hardware Finish is specified for width 48" - 72", add 29

The Infinity Screen Alignment clip can be placed to align two Infinity screens together.

**G X C C**

**WHAT'S INCLUDED**

1 alignment clip.

**Infinity Screen Alignment Clip**



**PRODUCT OPTIONS**

**Finish**

Foundation

Mica

Accent

**SAMPLE ORDER CODE**

**GXCC 74**

**PRICING**

Foundation	Accent/Mica
43	50

**GYFU**

**Framed Fabric Desk Edge Floor Screen**

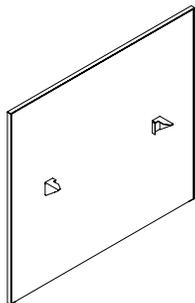

The Framed Floor Fabric Desk Edge Screen attaches to the worksurface on to provide an upholstered fabric screen that is outlined by frame that creates space division and local desktop privacy in at various heights both above and below the worksurface to the floor level.

**WHAT'S INCLUDED**

1 fabric desk edge screen, attachment brackets.

**NOTES**

Framed Floor screens match the width of the worksurface for tight fit applications. Recommended to have 1/2" wire gap between screen and worksurface.

Fabric will be applied in the railroad direction in select Panel and Upholstery fabrics, refer to the *Teknion Textiles Program Guide*.

**PRODUCT OPTIONS**

Modesty Base Height	Height	Width (in 1" increments)	Screen Finish	Hardware Finish
F Floor Height (1")	42 for 42" high datum 51 for 51" high datum	36 - 70	Panel Fabrics Upholstery Fabrics	Foundation Mica Accent

**SAMPLE ORDER CODE**

<b>GYFU F</b>	<b>42</b>	<b>60</b>	<b>B204</b>	<b>74</b>
---------------	-----------	-----------	-------------	-----------

**DIMENSIONS  
CODE / INCHES  
FOR MM X BY 25.4**

H	W
42	36-38
42	39-41
42	42-44
42	45-47
42	48-50
42	51-53
42	54-56
42	57-59
42	60-62
42	63-65
42	66-68
42	69
42	70

**PRICING**

**PANEL FABRIC**

COM/	Gr. 1	Gr. 2	Gr. 3	Gr. 4	Gr. 5
1200	1223	1255	1366	1445	1522
1302	1326	1358	1478	1564	1648
1400	1426	1463	1591	1680	1768
1421	1448	1487	1624	1720	1814
1444	1471	1513	1657	1757	1859
1537	1568	1609	1762	1869	1975
1629	1662	1707	1869	1980	2092
1645	1680	1726	1896	2013	2130
1660	1697	1748	1922	2046	2168
1737	1776	1828	2012	2140	2269
1813	1853	1906	2099	2232	2366
1830	1870	1925	2120	2257	2393
1845	1888	1944	2148	2289	2431

**UPHOLSTERY FABRIC**

COM/	Gr. 1	Gr. 2	Gr. 3	Gr. 4	Gr. 5	Gr. 6	Gr. 7	Gr. 8	Gr. 9	Gr. 10
1206	1299	1338	1395	1478	1529	1580	1684	1787	1833	
1309	1408	1448	1510	1600	1654	1709	1818	1932	1978	
1409	1513	1558	1624	1721	1779	1835	1953	2072	2123	
1431	1542	1590	1658	1762	1823	1884	2009	2134	2189	
1451	1570	1621	1695	1803	1867	1934	2064	2199	2255	
1546	1671	1725	1802	1916	1983	2052	2193	2335	2395	
1641	1771	1828	1909	2029	2101	2175	2321	2470	2533	
1657	1793	1854	1938	2064	2142	2216	2371	2528	2593	
1673	1816	1879	1968	2101	2180	2258	2421	2586	2654	
1750	1899	1966	2057	2197	2280	2363	2532	2703	2775	
1824	1981	2049	2148	2291	2378	2465	2642	2822	2895	
1843	2001	2071	2168	2317	2404	2492	2672	2853	2930	
1859	2025	2097	2199	2351	2442	2533	2722	2910	2990	

Pricing is continued on the following page.

If Accent/Mica Hardware Finish is specified for 36" - 41", add 14

If Accent/Mica Hardware Finish is specified for 42" - 70", add 29



**GYFU**

**Framed Fabric Desk Edge Floor Screen (Continued)**

**DIMENSIONS  
CODE / INCHES  
FOR MM X BY 25.4**

**PRICING**

H	W	PANEL FABRIC						UPHOLSTERY FABRIC									
		COM/ Gr. A	Gr. 1	Gr. 2	Gr. 3	Gr. 4	Gr.5	COM/ Gr. 1	Gr. 2	Gr. 3	Gr. 4	Gr. 5	Gr. 6	Gr. 7	Gr. 8	Gr. 9	Gr. 10
51	36-38	1233	1256	1287	1400	1477	1556	1241	1333	1371	1430	1513	1564	1614	1719	1820	1866
51	39-41	1333	1357	1389	1512	1596	1679	1340	1439	1480	1542	1632	1685	1740	1853	1964	2010
51	42-44	1431	1457	1492	1621	1710	1800	1439	1543	1590	1654	1751	1809	1865	1983	2102	2153
51	45-47	1451	1478	1517	1654	1750	1844	1461	1572	1620	1688	1792	1854	1914	2040	2166	2220
51	48-50	1474	1501	1543	1687	1787	1889	1483	1600	1651	1725	1833	1897	1964	2095	2229	2285
51	51-53	1567	1598	1641	1792	1899	2006	1575	1701	1755	1832	1946	2014	2082	2223	2365	2426
51	54-56	1659	1694	1737	1899	2010	2122	1671	1802	1858	1939	2061	2131	2205	2351	2500	2563
51	57-59	1675	1710	1756	1926	2043	2160	1687	1824	1884	1968	2095	2173	2246	2403	2559	2623
51	60-62	1693	1727	1778	1953	2076	2199	1703	1846	1909	1998	2131	2210	2288	2453	2615	2684
51	63-65	1767	1806	1858	2042	2170	2299	1780	1930	1996	2088	2228	2310	2393	2562	2734	2805
51	66-68	1843	1883	1936	2129	2261	2396	1855	2012	2079	2178	2325	2408	2495	2672	2852	2926
51	69	1860	1900	1956	2150	2287	2423	1873	2031	2101	2199	2348	2434	2522	2702	2883	2960
51	70	1876	1918	1973	2178	2319	2461	1889	2055	2126	2229	2381	2472	2563	2752	2940	3020

If Accent/Mica Hardware Finish is specified for 36" - 41", add 14

If Accent/Mica Hardware Finish is specified for 42" - 70", add 29

**GYEU**

**Framed Fabric Side Desk Edge Floor Screen**

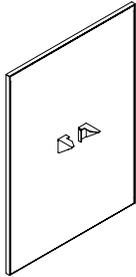

The Framed Side Floor Fabric Desk Edge Screen attaches to the worksurface on to provide an upholstered fabric screen that is outlined by frame that creates space division and local desktop privacy in at various heights both above and below the worksurface to the floor level.

**WHAT'S INCLUDED**

1 framed fabric desk edge screen, attachment brackets, corner connection hardware (if specified).

**NOTES**

Framed screens match the depth of the worksurface for tight fit applications.

Fabric will be applied in the railroad direction in select Panel and Upholstery fabrics, refer to the *Teknion Textiles Program Guide*.

**PRODUCT OPTIONS**

Modesty Base Height	Height	Depth	Corner Connection	Screen Finish	Hardware Finish
F Floor Height (1")	42 for 42" high datum 51 for 51" high datum	18, 24, 30, 36, 42, 48	N No R Right L Left	Panel Fabrics Upholstery Fabrics	Foundation Mica Accent

**SAMPLE ORDER CODE**

<b>GYEU F</b>	<b>42</b>	<b>24</b>	<b>R</b>	<b>B204</b>	<b>74</b>
---------------	-----------	-----------	----------	-------------	-----------

**DIMENSIONS  
INCHES / MM**

H	D
42 / 1067	18 / 457
42 / 1067	24 / 610
42 / 1067	30 / 762
42 / 1067	36 / 762
42 / 1067	42 / 1067
42 / 1067	48 / 1219
51 / 1295	18 / 457
51 / 1295	24 / 610
51 / 1295	30 / 762
51 / 1295	36 / 762
51 / 1295	42 / 1067
51 / 1295	48 / 1219

**PRICING**

**NO CORNER CONNECTION (N)**

**PANEL FABRIC**

COM/ Gr. A	Gr. 1	Gr. 2	Gr. 3	Gr. 4	Gr. 5
894	906	922	981	1022	1064
1000	1014	1035	1110	1162	1214
1087	1105	1131	1223	1286	1349
1202	1223	1253	1359	1436	1509
1402	1426	1461	1582	1671	1755
1444	1471	1512	1651	1749	1844
944	955	974	1033	1072	1113
1033	1046	1069	1144	1196	1249
1174	1192	1219	1310	1373	1437
1234	1256	1286	1393	1468	1542
1433	1457	1491	1614	1701	1785
1474	1501	1542	1681	1779	1875

**UPHOLSTERY FABRIC**

COM/ Gr. 1	Gr. 2	Gr. 3	Gr. 4	Gr. 5	Gr. 6	Gr. 7	Gr. 8	Gr. 9	Gr. 10
898	947	966	996	1041	1068	1094	1148	1203	1226
1004	1065	1092	1129	1185	1219	1252	1320	1389	1419
1094	1168	1200	1248	1315	1356	1395	1478	1564	1599
1207	1295	1333	1387	1468	1516	1564	1662	1761	1805
1409	1510	1552	1615	1707	1762	1817	1932	2044	2094
1453	1567	1615	1685	1791	1854	1915	2043	2173	2227
949	996	1016	1046	1092	1118	1144	1198	1253	1276
1038	1098	1125	1162	1219	1252	1285	1355	1422	1453
1180	1255	1286	1333	1402	1441	1483	1567	1650	1685
1242	1328	1365	1419	1500	1549	1597	1696	1793	1837
1439	1540	1582	1645	1737	1792	1848	1962	2074	2124
1485	1597	1645	1715	1820	1884	1945	2073	2202	2257

If Accent/Mica Hardware Finish is specified for width 18" - 42", add 14

If Accent/Mica Hardware Finish is specified for width 48", add 29

Pricing is continued on the following page.

**G Y E U**  
**Framed Fabric Side Desk Edge Floor**  
**Screen (Continued)**

**DIMENSIONS**  
**INCHES / MM**

**PRICING**

DIMENSIONS INCHES / MM		LEFT/RIGHT CORNER CONNECTION (L/R)															
		PANEL FABRIC						UPHOLSTERY FABRIC									
H	D	COM/ Gr. A	Gr. 1	Gr. 2	Gr. 3	Gr. 4	Gr. 5	COM/ Gr. 1	Gr. 2	Gr. 3	Gr. 4	Gr. 5	Gr. 6	Gr. 7	Gr. 8	Gr. 9	Gr. 10
42 / 1067	18 / 457	914	925	943	1003	1042	1083	918	966	986	1016	1061	1087	1113	1168	1223	1248
42 / 1067	24 / 610	1019	1034	1055	1130	1182	1234	1023	1084	1112	1150	1205	1237	1273	1341	1410	1440
42 / 1067	30 / 762	1107	1127	1152	1243	1306	1369	1113	1189	1221	1266	1335	1376	1416	1499	1582	1620
42 / 1067	36 / 762	1222	1243	1274	1380	1455	1528	1228	1315	1354	1408	1489	1537	1582	1682	1781	1824
42 / 1067	42 / 1067	1421	1446	1480	1603	1689	1776	1430	1529	1573	1634	1727	1783	1839	1950	2064	2115
42 / 1067	48 / 1219	1464	1492	1530	1672	1767	1865	1474	1588	1634	1705	1811	1873	1936	2063	2192	2246
51 / 1295	18 / 457	969	980	997	1057	1098	1137	974	1021	1041	1071	1116	1143	1168	1223	1279	1302
51 / 1295	24 / 610	1058	1072	1095	1170	1222	1274	1064	1124	1151	1189	1244	1279	1311	1380	1448	1478
51 / 1295	30 / 762	1200	1219	1244	1335	1398	1463	1205	1281	1312	1358	1427	1468	1509	1592	1675	1711
51 / 1295	36 / 762	1262	1283	1313	1419	1496	1569	1268	1356	1393	1447	1528	1575	1624	1724	1820	1865
51 / 1295	42 / 1067	1459	1483	1517	1641	1726	1811	1466	1567	1609	1672	1763	1817	1875	1988	2101	2150
51 / 1295	48 / 1219	1499	1528	1568	1707	1805	1900	1510	1622	1672	1741	1846	1909	1971	2100	2228	2283

If Accent/Mica Hardware Finish is specified for width 18" - 42", add 14

If Accent/Mica Hardware Finish is specified for width 48", add 29

**GVGU**

**Desk Edge Screen with Glass**

The Desk Edge Screen with Glass Top Screen attaches to the worksurface on to provide space division and local desktop privacy in at various heights both above and below the worksurface to the floor level.

**WHAT'S INCLUDED**

1 Desk Edge screen with glass top, attachment brackets, levelers.

**NOTES**

Edge trim will be finished to match the screen when Flintwood and Natural Veneer finishes have been specified. Edge trim on Fascia Laminate surfaces will have self edge trim options.

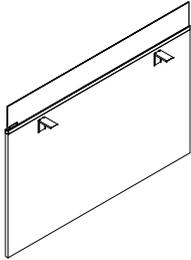

**PRODUCT OPTIONS**

Modesty Base Height	Height	Width	Screen Finish	Glass Finish	Hardware Finish
F Floor Height (1")	<b>A</b> 42" total (29" plus 13" glass) <b>B</b> 51" total (42" plus 9" glass) <b>C</b> 51" total (29" plus 22" glass) <b>D</b> 57" total (42" plus 15" glass)	46, 52, 58, 64, 70	Source Laminate Flintwood Natural Veneer	<b>CL</b> Clear <b>FT</b> Frost	Foundation Mica Accent

**SAMPLE ORDER CODE**

<b>GVGU F</b>	<b>A</b>	<b>60</b>	<b>5N</b>	<b>CL</b>	<b>74</b>
---------------	----------	-----------	-----------	-----------	-----------

**DIMENSIONS  
INCHES / MM**

H	W
42 / 1067	46 / 1168
42 / 1067	52 / 1321
42 / 1067	58 / 1473
42 / 1067	64 / 1626
42 / 1067	70 / 1778
51 / 1295	46 / 1168
51 / 1295	52 / 1321
51 / 1295	58 / 1473
51 / 1295	64 / 1626
51 / 1295	70 / 1778
51 / 1295	46 / 1168
51 / 1295	52 / 1321
51 / 1295	58 / 1473
57 / 1448	64 / 1626
57 / 1448	70 / 1778

**PRICING**

42" TOTAL (29" PLUS 13" GLASS) (A)							
SOURCE LAMINATE		FLINTWOOD		NATURAL VENEER			
Clear	Frost	Clear	Frost	Clear	Frost		
860	1084	1483	1577	1483	1761		
1102	1359	1892	1982	1892	2210		
1145	1421	1962	2064	1962	2300		
1394	1701	2374	2474	2374	2758		
1457	1781	2480	2590	2480	2884		
51" TOTAL (42" PLUS 9" GLASS) (B)							
SOURCE LAMINATE		FLINTWOOD		NATURAL VENEER			
Clear	Frost	Clear	Frost	Clear	Frost		
955	1145	1660	1704	1753	1903		
1192	1411	2063	2102	2177	2342		
1289	1528	2235	2274	2352	2533		
1378	1630	2378	2423	2507	2698		
1468	1740	2534	2584	2672	2879		
51" TOTAL (29" PLUS 22" GLASS) (C)							
SOURCE LAMINATE		FLINTWOOD		NATURAL VENEER			
Clear	Frost	Clear	Frost	Clear	Frost		
988	1303	1671	1843	1762	2055		
1235	1589	2077	2252	2190	2509		
1327	1710	2232	2424	2351	2699		
1421	1845	2381	2607	2511	2903		
1513	1975	2534	2785	2672	3100		

If Accent/Mica Hardware Finish is specified, add 25

Pricing is continued on the following page

**GVGU**  
**Desk Edge Screen with Glass**  
**(Continued)**

**DIMENSIONS**  
**INCHES / MM**

H	W
57 / 1448	46 / 1168
57 / 1448	52 / 1321
57 / 1448	58 / 1473
57 / 1448	64 / 1626
57 / 1448	70 / 1778

**PRICING**

57" TOTAL (42" PLUS 15" GLASS) (D)							
SOURCE LAMINATE		FLINTWOOD		NATURAL VENEER			
Clear	Frost	Clear	Frost	Clear	Frost		
1051	1259	1828	1875	1927	2093		
1311	1552	2456	2501	2589	2788		
1418	1681	2615	2665	2758	2967		
1516	1793	2790	2843	2940	3166		
1614	1914	2790	2843	2940	3166		

If Accent/Mica Hardware Finish is specified, add 25

## HTNN Modesty Screen

The Modesty Screen provides visual privacy below worksurface.

### WHAT'S INCLUDED

1 modesty screen, attachment brackets.

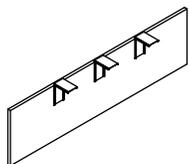

### PRODUCT OPTIONS

Height Below Worksurface	Width	Screen Finish	Metal Frame Finish
13 for 29" high datum	24, 30, 36, 42, 48, 54	Source Laminate Flintwood Natural Veneer	Foundation Mica Accent

### SAMPLE ORDER CODE

<b>HTNN 13</b>	<b>54</b>	<b>ZI</b>	<b>90</b>
----------------	-----------	-----------	-----------

### DIMENSIONS INCHES / MM

H	W
29 / 737	24 / 610
29 / 737	30 / 762
29 / 737	36 / 762
29 / 737	42 / 1067
29 / 737	48 / 1219
29 / 737	54 / 1372

### PRICING

	Source Laminate	Flintwood	Natural Veneer
24	242	479	504
30	254	520	545
36	265	564	586
42	273	608	633
48	339	705	736
54	349	751	782

If Accent/Mica is specified, add 25



## HTNL

### Solid Lateral Floor Screen

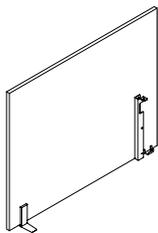

End Mounted Single,  
left handedness shown

The Lateral Screen attaches to a Stage to provide casual lateral space division.

#### WHAT'S INCLUDED

1 lateral solid screen, attachment brackets, support foot (width and mounting application dependent).

#### NOTES

Mounting Condition Support Foot:

- 44" to 84" Widths End Mounted Corner Connection
- 52" to 84" Widths End Mounted Single
- 44" to 84" Widths End Mounted Double
- No foot End Mounted Shared
- 36" to 72" Widths Flush Mid Gable
- 36" to 72" Widths Flush End Gable
- 52" to 84" Widths End Mounted Single for HA module
- 44" to 84" Widths End Mounted Double for HA module
- No foot End Mounted Shared for HA module

Support foot finish will automatically default to the bracket finish.

The left handed orientation will have the visible mounting brackets on the right and the support foot (if required) will be on the left.

The right handed orientation will have the visible mounting brackets on the left and the support foot (if required) will be on the right.

End Mounted Corner Connection includes alignment pins and cover caps.

#### PRODUCT OPTIONS

Bracket Attachment	Height	Width	Handedness	Screen Finish	Hardware Finish
<b>EC</b> End Mounted Corner Connection	42, 51, 57	24, 30, 36 42-84 (in 1" increments)	<b>L</b> Left	Source Laminate	Foundation
<b>ES</b> End Mounted Single			<b>R</b> Right	Flintwood	Mica
<b>EB</b> End Mounted Double			<b>N</b> Non Applicable	Natural Veneer	Accent
<b>ED</b> End Mounted Shared					
<b>FM</b> Flush Mid Gable					
<b>FE</b> Flush End Gable					
<b>HS</b> End Mounted Single for HA module					
<b>HB</b> End Mounted Double for HA module					
<b>HD</b> End Mounted Shared for HA module					

#### SAMPLE ORDER CODE

<b>HTNL ES</b>	<b>42</b>	<b>76</b>	<b>R</b>	<b>AG</b>	<b>74</b>
----------------	-----------	-----------	----------	-----------	-----------

See Pricing on the following page.



HTNL

Solid Lateral Screen (Continued)

DIMENSIONS INCHES / MM		PRICING		
H	W	Source Laminate	Flintwood	Natural Veneer
42 / 1067	24 / 610	461	729	800
42 / 1067	30 / 762	483	810	889
42 / 1067	36 / 762	532	1378	1512
42 / 1067	42 / 1067	583	985	1082
42 / 1067	43 / 1092	583	985	1082
42 / 1067	44 / 1118	583	985	1082
42 / 1067	45 / 1143	654	1101	1207
42 / 1067	46 / 1168	654	1101	1207
42 / 1067	47 / 1194	654	1101	1207
42 / 1067	48 / 1219	725	1218	1335
42 / 1067	49 / 1245	725	1218	1335
42 / 1067	50 / 1270	725	1218	1335
42 / 1067	51 / 1295	751	1262	1384
42 / 1067	52 / 1321	751	1262	1384
42 / 1067	53 / 1346	751	1262	1384
42 / 1067	54 / 1372	771	1304	1431
42 / 1067	55 / 1397	771	1304	1431
42 / 1067	56 / 1422	771	1304	1431
42 / 1067	57 / 1448	828	1395	1531
42 / 1067	58 / 1473	828	1395	1531
42 / 1067	59 / 1499	828	1395	1531
42 / 1067	60 / 1524	883	1489	1633
42 / 1067	61 / 1549	883	1489	1633
42 / 1067	62 / 1575	883	1489	1633
42 / 1067	63 / 1600	907	1529	1680
42 / 1067	64 / 1626	907	1529	1680
42 / 1067	65 / 1651	907	1529	1680
42 / 1067	66 / 1676	934	1572	1725
42 / 1067	67 / 1702	934	1572	1725
42 / 1067	68 / 1727	934	1572	1725
42 / 1067	69 / 1753	958	1619	1776
42 / 1067	70 / 1778	958	1619	1776
42 / 1067	71 / 1803	958	1619	1776
42 / 1067	72 / 1829	984	1660	1824
42 / 1067	73 / 1854	984	1660	1824
42 / 1067	74 / 1880	984	1660	1824
42 / 1067	75 / 1905	1024	1737	1908
42 / 1067	76 / 1930	1024	1737	1908
42 / 1067	77 / 1956	1024	1737	1908
42 / 1067	78 / 1981	1067	1810	1991
42 / 1067	79 / 2007	1067	1810	1991
42 / 1067	80 / 2032	1067	1810	1991
42 / 1067	81 / 2057	1102	1873	2057
42 / 1067	82 / 2083	1102	1873	2057
42 / 1067	83 / 2108	1102	1873	2057
42 / 1067	84 / 2134	1138	1936	2125

DIMENSIONS INCHES / MM		PRICING		
H	W	Source Laminate	Flintwood	Natural Veneer
51 / 1295	24 / 610	480	807	888
51 / 1295	30 / 762	542	910	997
51 / 1295	36 / 762	602	1549	1702
51 / 1295	42 / 1067	663	1113	1222
51 / 1295	43 / 1092	663	1113	1222
51 / 1295	44 / 1118	663	1113	1222
51 / 1295	45 / 1143	736	1241	1361
51 / 1295	46 / 1168	736	1241	1361
51 / 1295	47 / 1194	736	1241	1361
51 / 1295	48 / 1219	808	1365	1499
51 / 1295	49 / 1245	808	1365	1499
51 / 1295	50 / 1270	808	1365	1499
51 / 1295	51 / 1295	841	1416	1553
51 / 1295	52 / 1321	841	1416	1553
51 / 1295	53 / 1346	841	1416	1553
51 / 1295	54 / 1372	869	1467	1610
51 / 1295	55 / 1397	869	1467	1610
51 / 1295	56 / 1422	869	1467	1610
51 / 1295	57 / 1448	928	1567	1719
51 / 1295	58 / 1473	928	1567	1719
51 / 1295	59 / 1499	928	1567	1719
51 / 1295	60 / 1524	986	1663	1828
51 / 1295	61 / 1549	986	1663	1828
51 / 1295	62 / 1575	986	1663	1828
51 / 1295	63 / 1600	1016	1715	1884
51 / 1295	64 / 1626	1016	1715	1884
51 / 1295	65 / 1651	1016	1715	1884
51 / 1295	66 / 1676	1046	1764	1937
51 / 1295	67 / 1702	1046	1764	1937
51 / 1295	68 / 1727	1046	1764	1937
51 / 1295	69 / 1753	1076	1817	1996
51 / 1295	70 / 1778	1076	1817	1996
51 / 1295	71 / 1803	1076	1817	1996
51 / 1295	72 / 1829	1108	1870	2052
51 / 1295	73 / 1854	1108	1870	2052
51 / 1295	74 / 1880	1108	1870	2052
51 / 1295	75 / 1905	1158	1953	2144
51 / 1295	76 / 1930	1158	1953	2144
51 / 1295	77 / 1956	1158	1953	2144
51 / 1295	78 / 1981	1206	2039	2235
51 / 1295	79 / 2007	1206	2039	2235
51 / 1295	80 / 2032	1206	2039	2235
51 / 1295	81 / 2057	1251	2106	2313
51 / 1295	82 / 2083	1251	2106	2313
51 / 1295	83 / 2108	1251	2106	2313
51 / 1295	84 / 2134	1289	2179	2391

If Accent/Mica is specified, add 25

Pricing is continued on the following page.

## HTNL

### Solid Lateral Screen (Continued)

#### DIMENSIONS INCHES / MM

#### PRICING

H	W	Source Laminate	Flintwood	Natural Veneer
57 / 1448	24 / 610	526	888	978
57 / 1448	30 / 762	595	1002	1098
57 / 1448	36 / 762	661	1703	1873
57 / 1448	42 / 1067	728	1223	1343
57 / 1448	43 / 1092	728	1223	1343
57 / 1448	44 / 1118	728	1223	1343
57 / 1448	45 / 1143	808	1364	1498
57 / 1448	46 / 1168	808	1364	1498
57 / 1448	47 / 1194	808	1364	1498
57 / 1448	48 / 1219	889	1501	1650
57 / 1448	49 / 1245	889	1501	1650
57 / 1448	50 / 1270	889	1501	1650
57 / 1448	51 / 1295	925	1558	1710
57 / 1448	52 / 1321	925	1558	1710
57 / 1448	53 / 1346	925	1558	1710
57 / 1448	54 / 1372	957	1613	1771
57 / 1448	55 / 1397	957	1613	1771
57 / 1448	56 / 1422	957	1613	1771
57 / 1448	57 / 1448	1021	1724	1890
57 / 1448	58 / 1473	1021	1724	1890
57 / 1448	59 / 1499	1021	1724	1890
57 / 1448	60 / 1524	1085	1830	2010
57 / 1448	61 / 1549	1085	1830	2010
57 / 1448	62 / 1575	1085	1830	2010
57 / 1448	63 / 1600	1118	1888	2072
57 / 1448	64 / 1626	1118	1888	2072
57 / 1448	65 / 1651	1118	1888	2072
57 / 1448	66 / 1676	1152	1941	2131
57 / 1448	67 / 1702	1152	1941	2131
57 / 1448	68 / 1727	1152	1941	2131
57 / 1448	69 / 1753	1185	1999	2194
57 / 1448	70 / 1778	1185	1999	2194
57 / 1448	71 / 1803	1185	1999	2194
57 / 1448	72 / 1829	1220	2057	2257
57 / 1448	73 / 1854	1220	2057	2257
57 / 1448	74 / 1880	1220	2057	2257
57 / 1448	75 / 1905	1274	2150	2359
57 / 1448	76 / 1930	1274	2150	2359
57 / 1448	77 / 1956	1274	2150	2359
57 / 1448	78 / 1981	1327	2242	2456
57 / 1448	79 / 2007	1327	2242	2456
57 / 1448	80 / 2032	1327	2242	2456
57 / 1448	81 / 2057	1377	2317	2545
57 / 1448	82 / 2083	1377	2317	2545
57 / 1448	83 / 2108	1377	2317	2545
57 / 1448	84 / 2134	1418	2396	2630

If Accent/Mica is specified, add 25



## HTNA

### Solid Lateral Screen with Glass

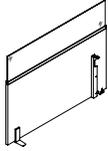

End Mounted Single,  
43" Total, left  
handedness shown

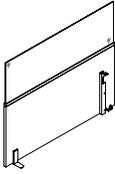

End Mounted Single,  
53" Total, left  
handedness shown

Solid Lateral Screen with Glass Top attaches to a Stage to provide casual lateral space division.

#### WHAT'S INCLUDED

1 lateral solid screen, attachment brackets, support foot (width and mounting application dependent).

#### NOTES

Mounting Condition Support Foot:

- End Mounted Single – 54" to 87" Widths
- End Mounted Double – 47" to 87" Widths
- End Mounted Shared – No foot
- Flush Mid Gable – 37" to 87" Widths
- Flush End Gable – 37" to 87" Widths

Support foot finish will automatically default to the bracket finish.

The left handed orientation will have the visible mounting brackets on the right and the support foot (if required) will be on the left.

The right handed orientation will have the visible mounting brackets on the left and the support foot (if required) will be on the right.

#### PRODUCT OPTIONS

Bracket Attachment	Height	Depth	Handedness	Screen Finish	Glass Finish	Hardware Finish
<b>ES</b> End Mounted Single	<b>A</b> 42" Total (29" plus 13" Glass)	25, 31, 37 43-87 (in 1" increments)	<b>L</b> Left	Source Laminate	<b>CL</b> Clear	Foundation
<b>EB</b> End Mounted Double			<b>R</b> Right			
<b>ED</b> End Mounted Shared	<b>B</b> 51" Total (42" plus 9" Glass)		<b>N</b> Non Applicable	Flintwood	<b>FT</b> Frost	Mica
<b>FM</b> Flush Mid Gable						
<b>FE</b> Flush End Gable	<b>C</b> 51" Total (29" plus 22" Glass)			Natural Veneer		Accent
<b>HS</b> End Mounted Single for HA module						
<b>HB</b> End Mounted Double for HA module	<b>D</b> 57" Total (42" plus 15" Glass)					
<b>HD</b> End Mounted Shared for HA module						

#### SAMPLE ORDER CODE

<b>HTNA ES</b>	<b>A</b>	<b>79</b>	<b>R</b>	<b>AG</b>	<b>CL</b>	<b>77</b>
----------------	----------	-----------	----------	-----------	-----------	-----------

See Pricing on the following page.

**H T N A**  
**Solid Lateral Screen with Glass**  
**(Continued)**

**DIMENSIONS**  
**INCHES / MM**

**PRICING**

H		D		42" TOTAL (29" PLUS 13" GLASS) (A)					
				SOURCE LAMINATE		FLINTWOOD		NATURAL VENEER	
				Clear	Frost	Clear	Frost	Clear	Frost
42 / 1067	24 / 610	608	696	984	1038	1054	1152		
42 / 1067	30 / 762	672	775	1091	1155	1168	1283		
42 / 1067	36 / 762	737	856	1197	1275	1282	1415		
42 / 1067	42 / 1067	803	935	1303	1389	1394	1542		
42 / 1067	43 / 1092	803	935	1303	1389	1394	1542		
42 / 1067	44 / 1118	803	935	1303	1389	1394	1542		
42 / 1067	45 / 1143	836	975	1354	1446	1448	1604		
42 / 1067	46 / 1168	836	975	1354	1446	1448	1604		
42 / 1067	47 / 1194	836	975	1354	1446	1448	1604		
42 / 1067	48 / 1219	867	1014	1406	1504	1504	1670		
42 / 1067	49 / 1245	867	1014	1406	1504	1504	1670		
42 / 1067	50 / 1270	867	1014	1406	1504	1504	1670		
42 / 1067	51 / 1295	981	1136	1590	1689	1703	1876		
42 / 1067	52 / 1321	981	1136	1590	1689	1703	1876		
42 / 1067	53 / 1346	981	1136	1590	1689	1703	1876		
42 / 1067	54 / 1372	1097	1256	1776	1875	1900	2080		
42 / 1067	55 / 1397	1097	1256	1776	1875	1900	2080		
42 / 1067	56 / 1422	1097	1256	1776	1875	1900	2080		
42 / 1067	57 / 1448	1115	1283	1807	1915	1936	2125		
42 / 1067	58 / 1473	1115	1283	1807	1915	1936	2125		
42 / 1067	59 / 1499	1115	1283	1807	1915	1936	2125		
42 / 1067	60 / 1524	1135	1310	1839	1950	1968	2164		
42 / 1067	61 / 1549	1135	1310	1839	1950	1968	2164		
42 / 1067	62 / 1575	1135	1310	1839	1950	1968	2164		
42 / 1067	63 / 1600	1251	1436	2025	2138	2170	2377		
42 / 1067	64 / 1626	1251	1436	2025	2138	2170	2377		
42 / 1067	65 / 1651	1251	1436	2025	2138	2170	2377		
42 / 1067	66 / 1676	1365	1557	2212	2328	2370	2586		
42 / 1067	67 / 1702	1365	1557	2212	2328	2370	2586		
42 / 1067	68 / 1727	1365	1557	2212	2328	2370	2586		
42 / 1067	69 / 1753	1395	1594	2260	2380	2423	2644		
42 / 1067	70 / 1778	1395	1594	2260	2380	2423	2644		
42 / 1067	71 / 1803	1395	1594	2260	2380	2423	2644		
42 / 1067	72 / 1829	1422	1628	2308	2432	2473	2702		
42 / 1067	73 / 1854	1422	1628	2308	2432	2473	2702		
42 / 1067	74 / 1880	1422	1628	2308	2432	2473	2702		
42 / 1067	75 / 1905	1453	1666	2357	2487	2524	2763		
42 / 1067	76 / 1930	1453	1666	2357	2487	2524	2763		
42 / 1067	77 / 1956	1453	1666	2357	2487	2524	2763		
42 / 1067	78 / 1981	1483	1701	2404	2541	2577	2823		
42 / 1067	79 / 2007	1483	1701	2404	2541	2577	2823		
42 / 1067	80 / 2032	1483	1701	2404	2541	2577	2823		
42 / 1067	81 / 2057	1512	1737	2454	2593	2630	2883		
42 / 1067	82 / 2083	1512	1737	2454	2593	2630	2883		
42 / 1067	83 / 2108	1512	1737	2454	2593	2630	2883		
42 / 1067	84 / 2134	1540	1773	2501	2645	2681	2940		

If Accent/Mica is specified, add 24

Pricing is continued on the following page.

**H T N A**

**Solid Lateral Screen with Glass  
(Continued)**

**DIMENSIONS  
INCHES / MM**

**PRICING**

		51" TOTAL (42" PLUS 9" GLASS) (B)					
		SOURCE LAMINATE		FLINTWOOD		NATURAL VENEER	
H	D	Clear	Frost	Clear	Frost	Clear	Frost
51 / 1295	24 / 610	647	716	1065	1095	1142	1218
51 / 1295	30 / 762	722	800	1182	1219	1267	1356
51 / 1295	36 / 762	796	887	1306	1349	1398	1500
51 / 1295	42 / 1067	867	969	1421	1474	1524	1637
51 / 1295	43 / 1092	867	969	1421	1474	1524	1637
51 / 1295	44 / 1118	867	969	1421	1474	1524	1637
51 / 1295	45 / 1143	911	1018	1496	1547	1602	1723
51 / 1295	46 / 1168	911	1018	1496	1547	1602	1723
51 / 1295	47 / 1194	911	1018	1496	1547	1602	1723
51 / 1295	48 / 1219	952	1068	1567	1622	1675	1803
51 / 1295	49 / 1245	952	1068	1567	1622	1675	1803
51 / 1295	50 / 1270	952	1068	1567	1622	1675	1803
51 / 1295	51 / 1295	1067	1185	1750	1805	1871	2006
51 / 1295	52 / 1321	1067	1185	1750	1805	1871	2006
51 / 1295	53 / 1346	1067	1185	1750	1805	1871	2006
51 / 1295	54 / 1372	1176	1299	1932	1983	2071	2209
51 / 1295	55 / 1397	1176	1299	1932	1983	2071	2209
51 / 1295	56 / 1422	1176	1299	1932	1983	2071	2209
51 / 1295	57 / 1448	1223	1354	2009	2063	2149	2297
51 / 1295	58 / 1473	1223	1354	2009	2063	2149	2297
51 / 1295	59 / 1499	1223	1354	2009	2063	2149	2297
51 / 1295	60 / 1524	1268	1406	2084	2144	2230	2382
51 / 1295	61 / 1549	1268	1406	2084	2144	2230	2382
51 / 1295	62 / 1575	1268	1406	2084	2144	2230	2382
51 / 1295	63 / 1600	1311	1449	2150	2212	2303	2461
51 / 1295	64 / 1626	1311	1449	2150	2212	2303	2461
51 / 1295	65 / 1651	1311	1449	2150	2212	2303	2461
51 / 1295	66 / 1676	1353	1494	2217	2277	2377	2534
51 / 1295	67 / 1702	1353	1494	2217	2277	2377	2534
51 / 1295	68 / 1727	1353	1494	2217	2277	2377	2534
51 / 1295	69 / 1753	1394	1543	2289	2352	2454	2619
51 / 1295	70 / 1778	1394	1543	2289	2352	2454	2619
51 / 1295	71 / 1803	1394	1543	2289	2352	2454	2619
51 / 1295	72 / 1829	1437	1591	2360	2428	2529	2702
51 / 1295	73 / 1854	1437	1591	2360	2428	2529	2702
51 / 1295	74 / 1880	1437	1591	2360	2428	2529	2702
51 / 1295	75 / 1905	1478	1641	2432	2504	2606	2787
51 / 1295	76 / 1930	1478	1641	2432	2504	2606	2787
51 / 1295	77 / 1956	1478	1641	2432	2504	2606	2787
51 / 1295	78 / 1981	1521	1688	2502	2577	2683	2869
51 / 1295	79 / 2007	1521	1688	2502	2577	2683	2869
51 / 1295	80 / 2032	1521	1688	2502	2577	2683	2869
51 / 1295	81 / 2057	1566	1737	2575	2653	2760	2954
51 / 1295	82 / 2083	1566	1737	2575	2653	2760	2954
51 / 1295	83 / 2108	1566	1737	2575	2653	2760	2954
51 / 1295	84 / 2134	1605	1785	2644	2727	2838	3037

If Accent/Mica is specified, add 24

Pricing is continued on the following page.

**HTNA**  
**Solid Lateral Screen with Glass**  
**(Continued)**

**DIMENSIONS**  
**INCHES / MM**

**PRICING**

H		D		51" TOTAL (29" PLUS 22" GLASS) (C)					
				SOURCE LAMINATE		FLINTWOOD		NATURAL VENEER	
				Clear	Frost	Clear	Frost	Clear	Frost
51 / 1295	24 / 610	663	793	1057	1155	1133	1281		
51 / 1295	30 / 762	736	889	1176	1294	1259	1434		
51 / 1295	36 / 762	808	981	1294	1427	1385	1579		
51 / 1295	42 / 1067	883	1078	1409	1566	1509	1731		
51 / 1295	43 / 1092	883	1078	1409	1566	1509	1731		
51 / 1295	44 / 1118	883	1078	1409	1566	1509	1731		
51 / 1295	45 / 1143	935	1144	1491	1657	1598	1833		
51 / 1295	46 / 1168	935	1144	1491	1657	1598	1833		
51 / 1295	47 / 1194	935	1144	1491	1657	1598	1833		
51 / 1295	48 / 1219	985	1204	1574	1748	1687	1934		
51 / 1295	49 / 1245	985	1204	1574	1748	1687	1934		
51 / 1295	50 / 1270	985	1204	1574	1748	1687	1934		
51 / 1295	51 / 1295	1101	1332	1758	1936	1884	2142		
51 / 1295	52 / 1321	1101	1332	1758	1936	1884	2142		
51 / 1295	53 / 1346	1101	1332	1758	1936	1884	2142		
51 / 1295	54 / 1372	1218	1457	1944	2123	2080	2350		
51 / 1295	55 / 1397	1218	1457	1944	2123	2080	2350		
51 / 1295	56 / 1422	1218	1457	1944	2123	2080	2350		
51 / 1295	57 / 1448	1259	1510	2013	2202	2156	2437		
51 / 1295	58 / 1473	1259	1510	2013	2202	2156	2437		
51 / 1295	59 / 1499	1259	1510	2013	2202	2156	2437		
51 / 1295	60 / 1524	1304	1566	2084	2280	2230	2523		
51 / 1295	61 / 1549	1304	1566	2084	2280	2230	2523		
51 / 1295	62 / 1575	1304	1566	2084	2280	2230	2523		
51 / 1295	63 / 1600	1348	1626	2152	2364	2305	2615		
51 / 1295	64 / 1626	1348	1626	2152	2364	2305	2615		
51 / 1295	65 / 1651	1348	1626	2152	2364	2305	2615		
51 / 1295	66 / 1676	1391	1685	2221	2448	2379	2706		
51 / 1295	67 / 1702	1391	1685	2221	2448	2379	2706		
51 / 1295	68 / 1727	1391	1685	2221	2448	2379	2706		
51 / 1295	69 / 1753	1436	1741	2290	2529	2455	2799		
51 / 1295	70 / 1778	1436	1741	2290	2529	2455	2799		
51 / 1295	71 / 1803	1436	1741	2290	2529	2455	2799		
51 / 1295	72 / 1829	1477	1799	2360	2611	2529	2887		
51 / 1295	73 / 1854	1477	1799	2360	2611	2529	2887		
51 / 1295	74 / 1880	1477	1799	2360	2611	2529	2887		
51 / 1295	75 / 1905	1521	1856	2430	2694	2605	2980		
51 / 1295	76 / 1930	1521	1856	2430	2694	2605	2980		
51 / 1295	77 / 1956	1521	1856	2430	2694	2605	2980		
51 / 1295	78 / 1981	1566	1912	2499	2773	2680	3068		
51 / 1295	79 / 2007	1566	1912	2499	2773	2680	3068		
51 / 1295	80 / 2032	1566	1912	2499	2773	2680	3068		
51 / 1295	81 / 2057	1607	1968	2570	2855	2756	3161		
51 / 1295	82 / 2083	1607	1968	2570	2855	2756	3161		
51 / 1295	83 / 2108	1607	1968	2570	2855	2756	3161		
51 / 1295	84 / 2134	1651	2025	2639	2936	2829	3249		

If Accent/Mica is specified, add 24

Pricing is continued on the following page.

## H T N A

### Solid Lateral Screen with Glass (Continued)

**DIMENSIONS**  
INCHES / MM

**PRICING**

		57" TOTAL (42" PLUS 15" GLASS) (D)					
		SOURCE LAMINATE		FLINTWOOD		NATURAL VENEER	
H	D	Clear	Frost	Clear	Frost	Clear	Frost
51 / 1295	24 / 610	711	789	1172	1204	1256	1338
51 / 1295	30 / 762	794	882	1302	1340	1394	1491
51 / 1295	36 / 762	875	977	1438	1485	1538	1651
51 / 1295	42 / 1067	952	1067	1564	1621	1677	1802
51 / 1295	43 / 1092	952	1067	1564	1621	1677	1802
51 / 1295	44 / 1118	952	1067	1564	1621	1677	1802
51 / 1295	45 / 1143	1003	1121	1644	1702	1762	1895
51 / 1295	46 / 1168	1003	1121	1644	1702	1762	1895
51 / 1295	47 / 1194	1003	1121	1644	1702	1762	1895
51 / 1295	48 / 1219	1048	1174	1724	1785	1844	1982
51 / 1295	49 / 1245	1048	1174	1724	1785	1844	1982
51 / 1295	50 / 1270	1048	1174	1724	1785	1844	1982
51 / 1295	51 / 1295	1173	1304	1925	1983	2058	2208
51 / 1295	52 / 1321	1173	1304	1925	1983	2058	2208
51 / 1295	53 / 1346	1173	1304	1925	1983	2058	2208
51 / 1295	54 / 1372	1295	1430	2124	2183	2277	2430
51 / 1295	55 / 1397	1295	1430	2124	2183	2277	2430
51 / 1295	56 / 1422	1295	1430	2124	2183	2277	2430
51 / 1295	57 / 1448	1347	1489	2210	2270	2364	2526
51 / 1295	58 / 1473	1347	1489	2210	2270	2364	2526
51 / 1295	59 / 1499	1347	1489	2210	2270	2364	2526
51 / 1295	60 / 1524	1395	1546	2290	2359	2454	2621
51 / 1295	61 / 1549	1395	1546	2290	2359	2454	2621
51 / 1295	62 / 1575	1395	1546	2290	2359	2454	2621
51 / 1295	63 / 1600	1441	1596	2365	2432	2533	2707
51 / 1295	64 / 1626	1441	1596	2365	2432	2533	2707
51 / 1295	65 / 1651	1441	1596	2365	2432	2533	2707
51 / 1295	66 / 1676	1487	1643	2440	2507	2614	2790
51 / 1295	67 / 1702	1487	1643	2440	2507	2614	2790
51 / 1295	68 / 1727	1487	1643	2440	2507	2614	2790
51 / 1295	69 / 1753	1534	1697	2519	2589	2699	2882
51 / 1295	70 / 1778	1534	1697	2519	2589	2699	2882
51 / 1295	71 / 1803	1534	1697	2519	2589	2699	2882
51 / 1295	72 / 1829	1580	1750	2594	2672	2781	2974
51 / 1295	73 / 1854	1580	1750	2594	2672	2781	2974
51 / 1295	74 / 1880	1580	1750	2594	2672	2781	2974
51 / 1295	75 / 1905	1627	1805	2675	2756	2866	3065
51 / 1295	76 / 1930	1627	1805	2675	2756	2866	3065
51 / 1295	77 / 1956	1627	1805	2675	2756	2866	3065
51 / 1295	78 / 1981	1673	1858	2752	2834	2951	3156
51 / 1295	79 / 2007	1673	1858	2752	2834	2951	3156
51 / 1295	80 / 2032	1673	1858	2752	2834	2951	3156
51 / 1295	81 / 2057	1723	1911	2830	2918	3036	3249
51 / 1295	82 / 2083	1723	1911	2830	2918	3036	3249
51 / 1295	83 / 2108	1723	1911	2830	2918	3036	3249
51 / 1295	84 / 2134	1767	1965	2910	3000	3121	3341

If Accent/Mica is specified, add 24



The Corridor Screen attaches to the stage to provide space division in single sided application or along a corridor.

**HTNC**

**Solid Corridor Screen**

**WHAT'S INCLUDED**

1 corridor screen and attachment bracket. Alignment pins and cover caps are included when specified.

**NOTES**

The Solid Screen is 1" thick. For corner application details refer to the application guide. Alignment holes include cover caps. Off module screens will need to have a connection to storage or a gable.

51" high only available to 90" wide.

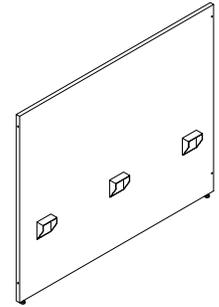

**PRODUCT OPTIONS**

Height	Width (6" increments)	Alignment	Screen Finish	Hardware Finish
42, 51	24-96	<b>N</b> Without Alignment <b>W</b> With In Line Alignment <b>R</b> Extended Right Corner and In Line Alignment <b>L</b> Extended Left Corner and In Line Alignment	Source Laminate Flintwood Natural Veneer	Foundation Mica Accent

**SAMPLE ORDER CODE**

<b>HTNC 42</b>	<b>60</b>	<b>R</b>	<b>AG</b>	<b>74</b>
----------------	-----------	----------	-----------	-----------

**DIMENSIONS  
INCHES / MM**

**PRICING**

**DIMENSIONS  
INCHES / MM**

**PRICING**

H	W
42 / 1067	24 / 610
42 / 1067	30 / 762
42 / 1067	36 / 762
42 / 1067	42 / 1067
42 / 1067	48 / 1219
42 / 1067	54 / 1372
42 / 1067	60 / 1524
42 / 1067	66 / 1676
42 / 1067	72 / 1829
42 / 1067	78 / 1981
42 / 1067	84 / 2134
42 / 1067	90 / 2286
42 / 1067	96 / 2438

Source Laminate	Flintwood	Natural Veneer
461	729	800
483	810	889
532	1378	1512
583	985	1082
725	1218	1335
771	1304	1431
883	1489	1633
934	1572	1725
984	1660	1824
1067	1810	1991
1138	1936	2125
1183	1976	2173
1249	2077	2283

H	W
51 / 1295	24 / 610
51 / 1295	30 / 762
51 / 1295	36 / 762
51 / 1295	42 / 1067
51 / 1295	48 / 1219
51 / 1295	54 / 1372
51 / 1295	60 / 1524
51 / 1295	72 / 1829
51 / 1295	78 / 1981
51 / 1295	78 / 1981
51 / 1295	84 / 2134
51 / 1295	90 / 2438

Source Laminate	Flintwood	Natural Veneer
480	807	888
542	910	997
602	1549	1702
663	1113	1222
808	1365	1499
869	1467	1610
986	1663	1828
1046	1764	1937
1108	1870	2052
1206	2039	2235
1289	2179	2391
1374	2280	2501

If Accent/Mica is specified, add 25

## HTNE

### Solid Corridor Screen with Glass

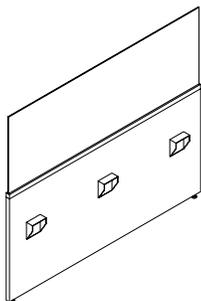

The Corridor Screen attaches to the stage to provide space division in single sided application or along a corridor.

#### WHAT'S INCLUDED

1 corridor screen and attachment bracket. Alignment pins and cover caps are included when specified.

#### NOTES

The Solid Screen is 1" thick. Off module screens will need to have a connection to storage or a gable .

51" high only available to 84" wide.

#### PRODUCT OPTIONS

Height	Width (6" increments)	Alignment	Screen Finish	Glass Finish	Hardware Finish
<b>A</b> 42" Total (29" plus 13" Glass)	24-96	<b>N</b> Without Alignment	Source Laminate	<b>CL</b> Clear	Foundation
<b>B</b> 51" Total (42" plus 9" Glass)		<b>W</b> With In Line Alignment	Flintwood	<b>FT</b> Frost	Mica
<b>C</b> 51" Total (29" plus 22" Glass)				Natural Veneer	

#### SAMPLE ORDER CODE

<b>HTNE A</b>	<b>60</b>	<b>W</b>	<b>AG</b>	<b>CL</b>	<b>74</b>
---------------	-----------	----------	-----------	-----------	-----------

#### DIMENSIONS INCHES / MM

H	W
42 / 1067	24 / 610
42 / 1067	30 / 762
42 / 1067	36 / 762
42 / 1067	42 / 1067
42 / 1067	48 / 1219
42 / 1067	54 / 1372
42 / 1067	60 / 1524
42 / 1067	66 / 1676
42 / 1067	72 / 1829
42 / 1067	78 / 1981
42 / 1067	84 / 2134
42 / 1067	90 / 2286
42 / 1067	96 / 2438

#### PRICING

##### 42" TOTAL (29" PLUS 23" GLASS) (A)

SOURCE LAMINATE		FLINTWOOD		NATURAL VENEER	
Clear	Frost	Clear	Frost	Clear	Frost
608	696	984	1038	1054	1152
672	775	1091	1155	1168	1283
737	856	1197	1275	1282	1415
803	935	1303	1389	1394	1542
867	1014	1406	1504	1504	1670
1097	1256	1776	1875	1900	2080
1135	1310	1839	1950	1968	2164
1365	1557	2212	2328	2370	2586
1422	1628	2308	2432	2473	2702
1483	1701	2404	2541	2577	2823
1540	1773	2501	2645	2681	2940
1685	1934	2734	2887	2930	3207
1788	2051	2903	3064	3111	3404

If Accent/Mica is specified, add 25

Pricing is continued on the following page.

**H T N E**  
**Solid Corridor Screen with Glass**  
**(Continued)**

**DIMENSIONS**  
**INCHES / MM**

H	W
51 / 1295	24 / 610
51 / 1295	30 / 762
51 / 1295	36 / 762
51 / 1295	42 / 1067
51 / 1295	48 / 1219
51 / 1295	54 / 1372
51 / 1295	60 / 1524
51 / 1295	72 / 1829
51 / 1295	78 / 1981
51 / 1295	78 / 1981
51 / 1295	84 / 2134
51 / 1295	90 / 2286

H	W
51 / 1295	24 / 610
51 / 1295	30 / 762
51 / 1295	36 / 762
51 / 1295	42 / 1067
51 / 1295	48 / 1219
51 / 1295	54 / 1372
51 / 1295	60 / 1524
51 / 1295	72 / 1829
51 / 1295	78 / 1981
51 / 1295	78 / 1981
51 / 1295	84 / 2134
51 / 1295	90 / 2286

**PRICING**

51" TOTAL (42" PLUS 9" GLASS) (B)							
SOURCE LAMINATE		FLINTWOOD		NATURAL VENEER			
Clear	Frost	Clear	Frost	Clear	Frost		
647	716	1065	1095	1142	1218		
722	800	1182	1219	1267	1356		
796	887	1306	1349	1398	1500		
867	969	1421	1474	1524	1637		
952	1068	1567	1622	1675	1803		
1176	1299	1932	1983	2071	2209		
1268	1406	2084	2144	2230	2382		
1353	1494	2217	2277	2377	2534		
1437	1591	2360	2428	2529	2702		
1521	1688	2502	2577	2683	2869		
1605	1785	2644	2727	2838	3037		
1733	1921	2852	2935	3058	3269		

51" TOTAL (29" PLUS 22" GLASS) (C)							
SOURCE LAMINATE		FLINTWOOD		NATURAL VENEER			
Clear	Frost	Clear	Frost	Clear	Frost		
663	793	1057	1155	1133	1281		
736	889	1176	1294	1259	1434		
808	981	1294	1427	1385	1579		
883	1078	1409	1566	1509	1731		
985	1204	1574	1748	1687	1934		
1218	1457	1944	2123	2080	2350		
1304	1566	2084	2280	2230	2523		
1391	1685	2221	2448	2379	2706		
1477	1799	2360	2611	2529	2887		
1566	1912	2499	2773	2680	3068		
1651	2025	2639	2936	2829	3249		
1785	2178	2853	3161	3058	3495		

If Accent/Mica is specified, add 25

## G N G U

### Glass 6mm Lateral Screen

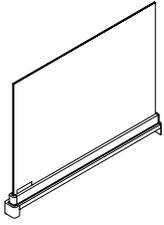

The Glass Lateral Screen attaches to the worksurface to provide lateral space division and privacy.

#### WHAT'S INCLUDED

Glass screen and attachment hardware.

#### NOTES

Designed for a full depth application. Specify depth of the screen that is same as worksurface depth only.

Can be applied to both flat and knife edge upStage worksurface.

Glass finishes are 6mm tempered glass.

Screen datum heights are:

- 42" (13" height of screen from worksurface)
- 51" (22" height of screen from worksurface)
- 57" (28" height of screen from worksurface)

#### PRODUCT OPTIONS

Height	Depth	Screen Finish	Hardware Finish
42 for 42" high datum	23, 29, 35	<b>CL</b> Clear <b>FT</b> Frost	Foundation
51 for 51" high datum			Mica
57 for 57" high datum			Accent

#### SAMPLE ORDER CODE

<b>GNGU 42</b>	<b>23</b>	<b>FT</b>	<b>74</b>
----------------	-----------	-----------	-----------

#### DIMENSIONS INCHES / MM

H	D
42 / 1067	23 / 584
42 / 1067	29 / 737
42 / 1067	35 / 889
51 / 1295	23 / 584
51 / 1295	29 / 737
51 / 1295	35 / 889
57 / 1448	23 / 584
57 / 1448	29 / 737
57 / 1448	35 / 889

#### PRICING

Standard Glass, Clear (CL)	Standard Glass, Frost (FT)
411	491
450	545
499	617
462	593
507	668
572	762
491	655
543	743
612	852

If Accent/Mica Hardware Finish is specified, add 14

The Glass Lateral Screen attaches to the worksurface to provide lateral space division and privacy.

**GNTU**

**Glass 10mm Lateral Screen**

**WHAT'S INCLUDED**

Glass screen and attachment hardware.

**NOTES**

Designed for a full depth application. Specify depth of the screen that is same as worksurface depth only.

Can be applied to both flat and knife edge upStage worksurface.

Glass finishes are 10mm tempered glass.

Screen datum heights are:

- 42" (13" height of screen from worksurface)
- 51" (22" height of screen from worksurface)
- 57" (28" height of screen from worksurface)

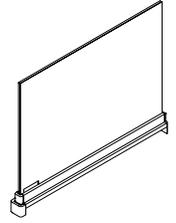

**PRODUCT OPTIONS**

Height	Depth	Screen Finish	Hardware Finish
42 for 42" high datum	23, 29, 35	CL Clear FT Frost	Foundation Mica Accent
51 for 51" high datum			
57 for 57" high datum			

**SAMPLE ORDER CODE**

<b>GNTU 42</b>	<b>23</b>	<b>FT</b>	<b>74</b>
----------------	-----------	-----------	-----------

**DIMENSIONS  
INCHES / MM**

H	D
42 / 1067	23 / 584
42 / 1067	29 / 737
42 / 1067	35 / 889
51 / 1295	23 / 584
51 / 1295	29 / 737
51 / 1295	35 / 889
57 / 1448	23 / 584
57 / 1448	29 / 737
57 / 1448	35 / 889

**PRICING**

Standard Glass, Clear (CL)	Standard Glass, Frost (FT)
427	559
479	631
544	716
513	702
578	800
661	917
556	778
631	897
724	1031

If Accent/Mica Hardware Finish is specified, add 14

## GNWU

### Writeable Glass Lateral Screen

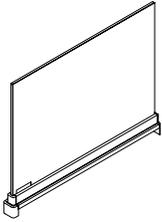

The Writeable Glass Lateral Screen attaches to the worksurface to provide additional functionality, lateral space division and privacy.

#### WHAT'S INCLUDED

Writeable Glass screen and attachment hardware.

#### NOTES

Designed for a full depth application. Specify depth of the screen that is same as worksurface depth only.

Can be applied to both flat and knife edge upStage worksurface.

Glass finishes are 10mm laminated glass.

Screen datum heights are:

- 42" (13" height of screen from worksurface)
- 51" (22" height of screen from worksurface)
- 57" (28" height of screen from worksurface)

#### PRODUCT OPTIONS

Height	Depth	Screen Finish	Hardware Finish
42 for 42" high datum 51 for 51" high datum 57 for 57" high datum	23, 29, 35	A6 Frost White H3 Polar White	Foundation Mica Accent

#### SAMPLE ORDER CODE

GNWU 42	23	G5	74
---------	----	----	----

#### DIMENSIONS INCHES / MM

H	D
42 / 1067	23 / 584
42 / 1067	29 / 737
42 / 1067	35 / 889
51 / 1295	23 / 584
51 / 1295	29 / 737
51 / 1295	35 / 889
57 / 1448	23 / 584
57 / 1448	29 / 737
57 / 1448	35 / 889

#### PRICING

Frost White (A6)	Polar White (H3)
567	650
645	732
738	830
766	800
881	886
944	992
849	975
980	1114
1131	1275

If Accent/Mica Hardware Finish is specified, add 14

The Solid Lateral Screen attaches to the worksurface to provide lateral space division and privacy.

**WHAT'S INCLUDED**

Solid screen and attachment hardware.

**NOTES**

Designed for a full depth application. Specify depth of the screen that is same as worksurface depth only.

Can be applied to both flat and knife edge upStage worksurface.

Screen datum heights are:

- 42" (13" height of screen from worksurface)
- 51" (22" height of screen from worksurface)
- 57" (28" height of screen from worksurface)

**GNSU  
Solid Lateral Screen**

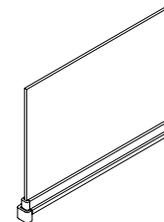

**PRODUCT OPTIONS**

Height	Depth	Screen Finish	Hardware Finish
42 for 42" high datum	23, 29, 35	Source Laminate	Foundation
51 for 51" high datum		Flintwood	Mica
57 for 57" high datum		Natural Veneer	Accent

**SAMPLE ORDER CODE**

<b>GNSU 42</b>	<b>23</b>	<b>ZA</b>	<b>74</b>
----------------	-----------	-----------	-----------

**DIMENSIONS  
INCHES / MM**

H	D
42 / 1067	23 / 584
42 / 1067	29 / 737
42 / 1067	35 / 889
51 / 1295	23 / 584
51 / 1295	29 / 737
51 / 1295	35 / 889
57 / 1448	23 / 584
57 / 1448	29 / 737
57 / 1448	35 / 889

**PRICING**

Source Laminate	Flintwood	Natural Veneer
376	618	634
409	677	696
467	740	761
422	718	738
464	794	817
543	888	913
462	792	812
512	875	898
597	978	1005

If Accent/Mica Hardware Finish is specified, add 14

## GNLU

### Writeable Laminate Lateral Screen

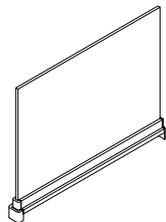

The Writeable Laminate Lateral Screen attaches to the worksurface to provide additional functionality, lateral space division and privacy.

#### WHAT'S INCLUDED

Writeable laminate screen and attachment hardware.

#### NOTES

Designed for a full depth application. Specify depth of the screen that is same as worksurface depth only.

Can be applied to both flat and knife edge upStage worksurface.

Screen datum heights are:

- 42" (13" height of screen from worksurface)

- 51" (22" height of screen from worksurface)

- 57" (28" height of screen from worksurface)

#### PRODUCT OPTIONS

Height	Depth	Screen Finish	Hardware Finish
42 for 42" high datum	23, 29, 35	Specialty Writeable Laminate	Foundation
51 for 51" high datum			Mica
57 for 57" high datum			Accent

#### SAMPLE ORDER CODE

<b>GNLU 42</b>	<b>29</b>	<b>5D</b>	<b>74</b>
----------------	-----------	-----------	-----------

#### DIMENSIONS INCHES / MM

H	D
42 / 1067	23 / 584
42 / 1067	29 / 737
42 / 1067	35 / 889
51 / 1295	23 / 584
51 / 1295	29 / 737
51 / 1295	35 / 889
57 / 1448	23 / 584
57 / 1448	29 / 737
57 / 1448	35 / 889

#### PRICING

Foundation	Accent/Mica
576	589
633	646
897	912
678	695
762	776
913	928
747	763
837	853
1005	1019



The Infinity Fabric Lateral Screen attaches to the worksurface to provide a lightweight, thin, upholstered fabric screen that is expressed in a softer curvilinear aesthetic that creates space division and lateral desktop privacy.

**GNXU**

**Infinity Lateral Screen**

**WHAT'S INCLUDED**

Infinity fabric screen and attachment hardware.

**NOTES**

Designed for a full depth application. Specify depth of the screen that is same as worksurface depth only.

Can be applied to both flat and knife edge upStage worksurface

Screen datum heights are:

- 42" (13" height of screen from worksurface)
- 51" (22" height of screen from worksurface)
- 57" (28" height of screen from worksurface)

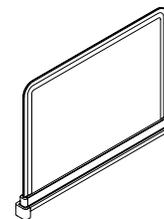

**PRODUCT OPTIONS**

Height	Depth	Screen Finish	Hardware Finish
42 for 42" high datum	23, 29, 35	Panel Fabrics	Foundation
51 for 51" high datum		Upholstery Fabrics	Mica
57 for 57" high datum			Accent

**SAMPLE ORDER CODE**

<b>GNXU 42</b>	<b>29</b>	<b>B204</b>	<b>74</b>
----------------	-----------	-------------	-----------

**DIMENSIONS  
INCHES / MM**

H	D
42 / 1067	23 / 584
42 / 1067	29 / 737
42 / 1067	35 / 889
51 / 1295	23 / 584
51 / 1295	29 / 737
51 / 1295	35 / 889
57 / 1448	23 / 584
57 / 1448	29 / 737
57 / 1448	35 / 889

**PRICING**

**PANEL FABRIC**

COM/ Gr. A	Gr. 1	Gr. 2	Gr. 3	Gr. 4	Gr. 5
751	755	762	789	805	822
815	821	829	859	882	902
869	876	887	922	948	973
833	841	853	889	916	942
890	899	913	959	991	1022
969	979	995	1048	1085	1122
883	890	904	943	971	997
971	980	995	1045	1080	1114
1068	1078	1097	1155	1196	1236

**UPHOLSTERY FABRIC**

COM/ Gr. 1	Gr. 2	Gr. 3	Gr. 4	Gr. 5	Gr. 6	Gr. 7	Gr. 8	Gr. 9	Gr. 10
752	770	781	793	812	823	833	857	881	889
817	843	853	868	890	904	917	947	974	985
872	901	914	932	959	975	991	1023	1057	1071
836	867	881	898	927	943	961	995	1030	1044
894	932	948	971	1005	1024	1045	1087	1129	1146
973	1015	1034	1061	1101	1127	1150	1200	1250	1269
887	918	934	951	982	1000	1018	1054	1091	1107
975	1015	1033	1058	1095	1116	1140	1183	1230	1250
1071	1120	1138	1168	1214	1242	1267	1324	1377	1400

If Accent/Mica Hardware Finish is specified, add 14

## GNZU

### Smooth Felt Lateral Screen

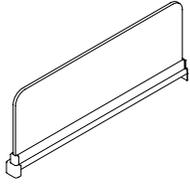

The Smooth Felt Lateral Screen attaches to the worksurface to provide lateral space division and privacy.

#### WHAT'S INCLUDED

Smooth Felt screen and attachment hardware.

#### NOTES

Designed for a full depth application. Specify depth of the screen that is same as worksurface depth only. Can be applied to both flat and knife edge upStage worksurface.

Screen datum heights are:

- 42" (13" height of screen from worksurface)
- 51" (22" height of screen from worksurface)
- 57" (28" height of screen from worksurface)

#### PRODUCT OPTIONS

Height	Depth	Smooth Felt Finish	Hardware Finish
42 for 42" high datum 51 for 51" high datum	23, 29, 35	Smooth Felt Colors	Foundation Mica Accent

#### SAMPLE ORDER CODE

<b>GNZU 42</b>	<b>29</b>	<b>R4</b>	<b>74</b>
----------------	-----------	-----------	-----------

#### DIMENSIONS INCHES / MM

H	D
42 / 1067	23 / 584
42 / 1067	29 / 737
42 / 1067	35 / 889
51 / 1295	23 / 584
51 / 1295	29 / 737
51 / 1295	35 / 889

#### PRICING

Foundation	Accent/Mica
390	402
491	507
529	545
498	520
593	612
635	654

The Framed Fabric Lateral Screen attaches to the worksurface to provide lateral space division and privacy.

**GNYU**

**Framed Fabric Lateral Screen**

**WHAT'S INCLUDED**

Framed fabric screen and attachment hardware.

**NOTES**

Designed for a full depth application. Specify depth of the screen that is same as worksurface depth only.

Can be applied to both flat and knife edge upStage worksurface.

Screen datum heights are:

- 42" (13" height of screen from worksurface)
- 51" (22" height of screen from worksurface)
- 57" (28" height of screen from worksurface)

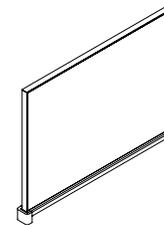

**PRODUCT OPTIONS**

Height	Depth	Screen Finish	Hardware Finish
42 for 42" high datum	23, 29, 35	Panel Fabrics Upholstery Fabrics	Foundation
51 for 51" high datum			Mica
57 for 57" high datum			Accent

**SAMPLE ORDER CODE**

<b>GNYU 42</b>	<b>23</b>	<b>B204</b>	<b>74</b>
----------------	-----------	-------------	-----------

**DIMENSIONS  
INCHES / MM**

H	D
42 / 1067	23 / 584
42 / 1067	29 / 737
42 / 1067	35 / 889
51 / 1295	23 / 584
51 / 1295	29 / 737
51 / 1295	35 / 889
57 / 1448	23 / 584
57 / 1448	29 / 737
57 / 1448	35 / 889

**PRICING**

**PANEL FABRIC**

COM/ Gr. A	Gr. 1	Gr. 2	Gr. 3	Gr. 4	Gr. 5
713	717	726	751	766	783
776	782	791	821	841	860
828	834	845	881	904	928
793	800	810	846	872	897
849	857	869	914	944	975
922	934	948	1002	1038	1072
822	830	843	881	907	934
880	889	902	950	982	1015
957	969	984	1040	1080	1116

**UPHOLSTERY FABRIC**

COM/ Gr. 1	Gr. 2	Gr. 3	Gr. 4	Gr. 5	Gr. 6	Gr. 7	Gr. 8	Gr. 9	Gr. 10
715	736	743	756	775	785	796	819	838	850
778	801	812	828	850	861	875	902	929	942
830	859	871	888	916	929	947	978	1011	1023
796	824	837	857	884	899	916	949	981	996
851	887	902	924	958	978	997	1039	1078	1097
925	969	988	1014	1053	1075	1099	1148	1196	1218
826	857	871	889	920	935	954	989	1027	1040
883	922	937	962	1000	1018	1040	1084	1127	1144
961	1007	1024	1054	1095	1121	1144	1197	1249	1272

If Accent/Mica Hardware Finish is specified, add 14

## GNMU Metal Lateral Screen

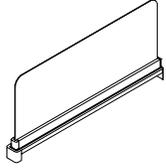

The Metal Lateral Screen attaches to the worksurface to provide a thin, metal screen that is expressed in a softer curvilinear aesthetic with an opportunity to add color that creates space division and lateral desktop privacy.

### WHAT'S INCLUDED

Metal screen and attachment hardware.

### NOTES

Designed for a full depth application. Specify depth of the screen that is same as worksurface depth only.

Can be applied to both flat and knife edge Interpret worksurface. Available at 42" datum height only.

Screen datum heights are:

- 42" (13" height of screen from worksurface)
- 51" (22" height of screen from worksurface)
- 57" (28" height of screen from worksurface)

### PRODUCT OPTIONS

Height	Depth	Finish	Hardware Finish
42 for 42" high datum 51 for 51" high datum	23, 29, 35	Foundation Mica Accent	Foundation Mica Accent

### SAMPLE ORDER CODE

<b>GNMU 42</b>	<b>23</b>	<b>E</b>	<b>74</b>
----------------	-----------	----------	-----------

### DIMENSIONS INCHES / MM

H	D
42 / 1067	23 / 584
42 / 1067	29 / 737
42 / 1067	35 / 889
51 / 1295	23 / 584
51 / 1295	29 / 737
51 / 1295	35 / 889

### PRICING

Foundation Finish	Mica/Accent Finish
389	404
424	446
473	496
417	434
457	482
511	536

If Accent/Mica Hardware Finish is specified, add 14



functional screens

# product map

**H T C F Functional Screen Frame**

Page 416



**H T C T Top Trim**

Page 417



**H T C G Top Trim for Glass Add-On**

Page 418



**H T C E End Trim**

Page 419



**H T C R Fabric Fascia**

Page 420

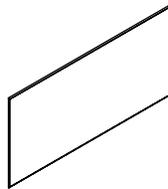

**H T C W Whiteboard Fascia**

Page 422

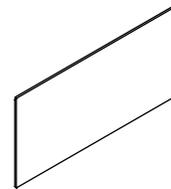

**H T C A Accessory Fascia**

Page 423

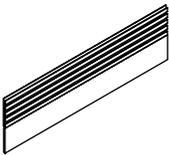

**H T C K Fascia Post Kit**

Page 424



**H T C L Glass Add-On Screen**

Page 425

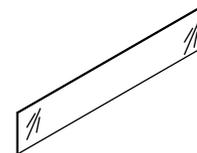

**H T C C Screen Connector**

Page 426



## HTCF

### Functional Screen Frame



The Functional Screen Frame is the main raw structure that mounts to the center Accessory Rail to provide privacy and functionality.

#### WHAT'S INCLUDED

2 or 4 vertical posts, horizontal rail and mounting brackets.

#### NOTES

The Top Trim (HTCT), End Trims (HTCE) and Fascias must be specified separately.

Frames over 48" wide will consist of two segments for added stability.

Screen Connectors (HTCC) must be specified separately if Functional Screen Frame (HTCF) is to be connected to another Functional Screen Frame to create a continuous screen.

#### PRODUCT OPTIONS

Height	Width
13, 21, 30	24, 30, 36, 42, 48, 54, 60, 66, 72, 78, 84, 90, 96

#### SAMPLE ORDER CODE

HTCF 21	72
---------	----

#### DIMENSIONS INCHES / MM

H	W
13 / 330	24 / 610
13 / 330	30 / 762
13 / 330	36 / 762
13 / 330	42 / 1067
13 / 330	48 / 1219
13 / 330	54 / 1372
13 / 330	60 / 1524
13 / 330	66 / 1676
13 / 330	72 / 1829
13 / 330	78 / 1981
13 / 330	84 / 2134
13 / 330	90 / 2286
13 / 330	96 / 2438
21 / 533	24 / 610
21 / 533	30 / 762
21 / 533	36 / 762
21 / 533	42 / 1067
21 / 533	48 / 1219
21 / 533	54 / 1372
21 / 533	60 / 1524
21 / 533	66 / 1676
21 / 533	72 / 1829
21 / 533	78 / 1981
21 / 533	84 / 2134
21 / 533	90 / 2286
21 / 533	96 / 2438

#### PRICING

300
317
340
369
391
451
499
511
550
565
575
588
604
316
340
362
394
417
481
534
548
588
606
615
634
646

#### DIMENSIONS INCHES / MM

H	W
30 / 762	24 / 610
30 / 762	30 / 762
30 / 762	36 / 762
30 / 762	42 / 1067
30 / 762	48 / 1219
30 / 762	54 / 1372
30 / 762	60 / 1524
30 / 762	66 / 1676
30 / 762	72 / 1829
30 / 762	78 / 1981
30 / 762	84 / 2134
30 / 762	90 / 2286
30 / 762	96 / 2438

#### PRICING

338
362
384
420
438
510
565
580
625
641
654
671
685



The Top Trim is required to finish off the top of the Functional Screens.

**WHAT'S INCLUDED**

1 top trim.

**NOTES**

Top Trim can span more than one frame.

Top Trim **cannot** accommodate a glass add-on.

**HTCT  
Top Trim**



**PRODUCT OPTIONS**

Width	Finish
24, 30, 36, 42, 48, 54, 60, 66, 72, 78, 84, 90, 96	Foundation Mica Accent

**SAMPLE ORDER CODE**

<b>HTCT 24</b>	<b>74</b>
----------------	-----------

**DIMENSIONS  
INCHES / MM**

W
24 / 610
30 / 762
36 / 762
42 / 1067
48 / 1219
54 / 1372
60 / 1524
66 / 1676
72 / 1829
78 / 1981
84 / 2134
90 / 2286
96 / 2438

**PRICING**

	Foundation	Accent/Mica
	39	48
	41	51
	44	52
	48	54
	51	55
	70	80
	74	83
	80	84
	81	87
	97	103
	99	104
	103	113
	111	117

## HTCG

### Top Trim for Glass Add-On

The Top Trim for Glass Add-On is required to finish off the top of the Functional Screens when a glass add-on is desired.

#### WHAT'S INCLUDED

1 top trim, additional clips to hold glass blade.

#### NOTES

Top Trim can span more than one frame.

Top Cover is removed only when Add-On Screens are applied.



#### PRODUCT OPTIONS

Width	Finish
24, 30, 36, 42, 48, 54, 60, 66, 72, 78, 84, 90, 96	Foundation Mica Accent

#### SAMPLE ORDER CODE

HTCG 24	74
---------	----

#### DIMENSIONS INCHES / MM

W
24 / 610
30 / 762
36 / 762
42 / 1067
48 / 1219
54 / 1372
60 / 1524
66 / 1676
72 / 1829
78 / 1981
84 / 2134
90 / 2286
96 / 2438

#### PRICING

	Foundation	Accent/Mica
	69	81
	71	84
	78	87
	81	92
	84	94
	121	130
	127	140
	130	142
	133	148
	164	180
	174	181
	180	187
	186	197

The End Trim is required to finish off the ends of the Functional or Basic Screen.

**HTCE**  
**End Trim**

**WHAT'S INCLUDED**

1 end trim.

**NOTES**

Required for Functional Screen Frame (HTCF) only as Lateral Spine Screen Frames includes an End Trim with integrated fastening brackets.

Must be specified at each end of the Functional Screen Frame (HTCF) only two End Trims are required to finish off a Continuous Functional Screen (HTCF) or a combination of both.



**PRODUCT OPTIONS**

Height	Finish
13, 21, 30	Foundation Mica Accent

**SAMPLE ORDER CODE**

<b>HTCE 21</b>	<b>74</b>
----------------	-----------

**DIMENSIONS  
INCHES / MM**

H
13 / 330
21 / 533
30 / 762

**PRICING**

Foundation	Accent/Mica
70	71
92	96
100	104

## HTCR Fabric Fascia

The Fabric Fascia mounts to the Functional Screen Frame to provide a tackable surface.

### WHAT'S INCLUDED

1 fabric fascia and attachment clips.

### NOTES

Must be mounted onto a Functional Screen Frame (HTCF) **cannot** be used on its own.

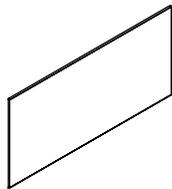

### PRODUCT OPTIONS

Height	Width	Screen Finish
13, 21, 30	24, 27, 30, 33, 36, 39, 42, 45, 48, 54, 60	Panel Fabric

### SAMPLE ORDER CODE

<b>HTCR 13</b>	<b>48</b>	<b>L308</b>
----------------	-----------	-------------

### DIMENSIONS INCHES / MM

H	W
13 / 330	24 / 610
13 / 330	27 / 686
13 / 330	30 / 762
13 / 330	33 / 838
13 / 330	36 / 762
13 / 330	39 / 991
13 / 330	42 / 1067
13 / 330	45 / 1143
13 / 330	48 / 1219
13 / 330	54 / 1372
13 / 330	60 / 1524
21 / 533	24 / 610
21 / 533	27 / 686
21 / 533	30 / 762
21 / 533	33 / 838
21 / 533	36 / 762
21 / 533	39 / 991
21 / 533	42 / 1067
21 / 533	45 / 1143
21 / 533	48 / 1219
21 / 533	54 / 1372
21 / 533	60 / 1524

### PRICING

COM/ Gr. A	Gr. 1	Gr. 2	Gr. 3	Gr. 4	Gr. 5	Gr. 6	Gr. 7
112	114	117	121	124	126	129	133
121	124	127	129	131	134	141	145
124	129	133	140	144	148	152	156
129	133	140	143	149	152	156	159
133	141	145	151	154	157	160	164
142	149	153	157	160	163	167	175
163	171	176	181	186	188	194	204
165	176	180	184	189	193	203	208
175	181	186	191	197	205	210	214
187	197	205	210	214	218	225	235
197	208	212	217	223	228	238	243
130	133	140	143	149	152	156	159
143	148	152	156	159	161	165	174
157	159	163	167	175	179	183	188
167	175	179	182	186	189	197	205
176	180	184	189	195	204	209	213
179	182	187	193	202	206	211	216
206	210	214	219	225	234	241	247
217	220	228	235	241	246	254	263
224	233	240	246	254	259	268	276
254	259	268	273	281	287	298	307
278	284	294	301	309	315	328	338

Pricing is continued on the following page.

**H T C R**  
**Fabric Fascia (Continued)**

**DIMENSIONS**  
**INCHES / MM**

**PRICING**

DIMENSIONS		PRICING							
H	W	COM/ Gr. A	Gr. 1	Gr. 2	Gr. 3	Gr. 4	Gr. 5	Gr. 6	Gr. 7
30 / 762	24 / 610	156	158	163	171	178	181	186	191
30 / 762	27 / 686	167	174	179	183	188	193	203	208
30 / 762	30 / 762	188	193	203	208	212	217	224	235
30 / 762	33 / 838	212	216	220	228	238	242	249	258
30 / 762	36 / 762	216	219	228	239	246	250	263	268
30 / 762	39 / 991	217	220	233	240	247	254	263	270
30 / 762	42 / 1067	244	251	263	269	276	285	296	307
30 / 762	45 / 1143	270	276	284	294	302	309	317	330
30 / 762	48 / 1219	282	287	299	309	318	328	338	347
30 / 762	54 / 1372	325	331	340	349	362	369	381	394
30 / 762	60 / 1524	367	371	384	395	406	419	429	445

## HTCW Whiteboard Fascia

The Whiteboard Fascia mounts to the Functional Screen Frame to provide an economical writable surface.

### WHAT'S INCLUDED

1 whiteboard fascia and attachment clips.

### NOTES

Must be mounted onto a Functional Screen Frame (HTCF) **cannot** be used on its own.

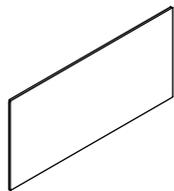

### PRODUCT OPTIONS

Height	Width
13, 21, 30	24, 27, 30, 33, 36, 39, 42, 45, 48, 54, 60, 66, 72

### SAMPLE ORDER CODE

HTCW 13	48
---------	----

### DIMENSIONS INCHES / MM

H	W
13 / 330	24 / 610
13 / 330	27 / 686
13 / 330	30 / 762
13 / 330	33 / 838
13 / 330	36 / 762
13 / 330	39 / 991
13 / 330	42 / 1067
13 / 330	45 / 1143
13 / 330	48 / 1219
13 / 330	54 / 1372
13 / 330	60 / 1524
13 / 330	66 / 1676
13 / 330	72 / 1829
21 / 533	24 / 610
21 / 533	27 / 686
21 / 533	30 / 762
21 / 533	33 / 838
21 / 533	36 / 762
21 / 533	39 / 991
21 / 533	42 / 1067
21 / 533	45 / 1143
21 / 533	48 / 1219
21 / 533	54 / 1372
21 / 533	60 / 1524
21 / 533	66 / 1676
21 / 533	72 / 1829

### PRICING

53
57
60
70
78
83
88
90
94
119
129
148
164
78
83
88
96
100
114
124
129
134
161
179
206
224

### DIMENSIONS INCHES / MM

H	W
30 / 762	24 / 610
30 / 762	27 / 686
30 / 762	30 / 762
30 / 762	33 / 838
30 / 762	36 / 762
30 / 762	39 / 991
30 / 762	42 / 1067
30 / 762	45 / 1143
30 / 762	48 / 1219
30 / 762	54 / 1372
30 / 762	60 / 1524
30 / 762	66 / 1676
30 / 762	72 / 1829

### PRICING

101
112
119
124
129
151
163
175
183
213
233
270
294

The Accessory Fascia mounts to the Functional Screen Frame and allows the mounting of accessories.

# HTCA

## Accessory Fascia

### WHAT'S INCLUDED

1 accessory fascia and attachment clips.

### NOTES

Must be mounted onto a Functional Screen Frame (HTCF), **cannot** be used on their own.

Additional posts are required for stability when mounting Accessory Fascias. See *Application Guides* for more details.

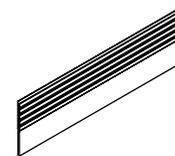

### PRODUCT OPTIONS

Height	Width	Finish
13	24, 27, 30, 33, 36, 39, 42, 45, 48, 54, 60, 66, 72	Foundation Mica Accent

### SAMPLE ORDER CODE

<b>HTCA 13</b>	<b>48</b>	<b>74</b>
----------------	-----------	-----------

### DIMENSIONS INCHES / MM

H	W
13 / 330	24 / 610
13 / 330	27 / 686
13 / 330	30 / 762
13 / 330	33 / 838
13 / 330	36 / 762
13 / 330	39 / 991
13 / 330	42 / 1067
13 / 330	45 / 1143
13 / 330	48 / 1219
13 / 330	54 / 1372
13 / 330	60 / 1524
13 / 330	66 / 1676
13 / 330	72 / 1829

### PRICING

Foundation	Accent/Mica
157	160
164	171
176	180
184	189
197	206
210	214
216	220
224	234
238	244
269	276
300	309
330	340
362	371

## HTCK

### Fascia Post Kit

The Fascia Post Kit provides additional vertical support to the Screen Frames when an Accessory or Wood Fascia is desired.

#### WHAT'S INCLUDED

- For sizes 24" - 30" - 1 post kit.
- For sizes 33" - 42" - 2 post kits.
- For sizes 45" - 48" - 3 post kits.
- For sizes 54" - 60" - 2 post kits.
- For sizes 66" - 72" - 4 post kits.



#### PRODUCT OPTIONS

Height	Width of Fascia
13, 21	24, 27, 30, 33, 36, 39, 42, 45, 48, 54, 60, 66, 72

#### SAMPLE ORDER CODE

<b>HTCK 13</b>	<b>48</b>
----------------	-----------

#### DIMENSIONS INCHES / MM

H	W
13 / 330	24 / 610
13 / 330	27 / 686
13 / 330	30 / 762
13 / 330	33 / 838
13 / 330	36 / 762
13 / 330	39 / 991
13 / 330	42 / 1067
13 / 330	45 / 1143
13 / 330	48 / 1219
13 / 330	54 / 1372
13 / 330	60 / 1524
13 / 330	66 / 1676
13 / 330	72 / 1829
21 / 533	24 / 610
21 / 533	27 / 686
21 / 533	30 / 762
21 / 533	33 / 838
21 / 533	36 / 762
21 / 533	39 / 991
21 / 533	42 / 1067
21 / 533	45 / 1143
21 / 533	48 / 1219
21 / 533	54 / 1372
21 / 533	60 / 1524
21 / 533	66 / 1676
21 / 533	72 / 1829

#### PRICING

80
80
80
156
156
156
156
233
233
156
156
309
309
99
99
99
204
204
204
204
301
301
204
204
204
400
400



The 8" Add-On Glass Screen is specified with a 13" Accessory Beam to reach 42" datum and the 9" Add-On Glass Screen is added to a 42" screen to reach 51" in height.

# HTCL Glass Add-On Screen

### WHAT'S INCLUDED

1 glass screen.

### NOTES

Cannot be mounted onto a Top Trim (HTCT).

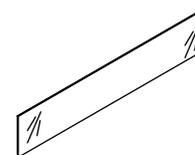

### PRODUCT OPTIONS

Height	Width	Screen Finish
8, 9	24, 30, 36, 42, 48, 54, 60, 66, 72, 78, 84, 90, 96	CL Clear FT Frost

### SAMPLE ORDER CODE

<b>HTCL 8</b>	<b>48</b>	<b>CL</b>
---------------	-----------	-----------

### DIMENSIONS INCHES / MM

H	W
8 / 203	24 / 610
8 / 203	30 / 762
8 / 203	36 / 762
8 / 203	42 / 1067
8 / 203	48 / 1219
8 / 203	54 / 1372
8 / 203	60 / 1524
8 / 203	66 / 1676
8 / 203	72 / 1829
8 / 203	78 / 1981
8 / 203	84 / 2134
8 / 203	90 / 2286
8 / 203	96 / 2438
9 / 229	24 / 610
9 / 229	30 / 762
9 / 229	36 / 762
9 / 229	42 / 1067
9 / 229	48 / 1219
9 / 229	54 / 1372
9 / 229	60 / 1524
9 / 229	66 / 1676
9 / 229	72 / 1829
9 / 229	78 / 1981
9 / 229	84 / 2134
9 / 229	90 / 2286
9 / 229	96 / 2438

### PRICING

Clear Glass	Frost Glass
88	156
97	171
110	188
124	216
136	241
152	266
165	294
181	315
193	341
210	365
223	393
240	420
254	443
88	156
97	171
110	188
124	216
136	241
152	266
165	294
181	315
193	341
210	365
223	393
240	420
254	443

## HTCC Screen Connector

The Screen Connector is used to connect Spine Screen Frames together in a continuous run.

### WHAT'S INCLUDED

1 screen connector.

### NOTES

Can connect Functional Spine Screen Frame (HTCF).



### PRODUCT OPTIONS

#### Height

13, 21, 30

### SAMPLE ORDER CODE

HTCC 21

### DIMENSIONS INCHES / MM

H
13 / 330
21 / 533
30 / 762

### PRICING

63
80
90



hutch stackers &  
accessories

# product map

## H T S H N Open Through Hutch Stacker

Page 432

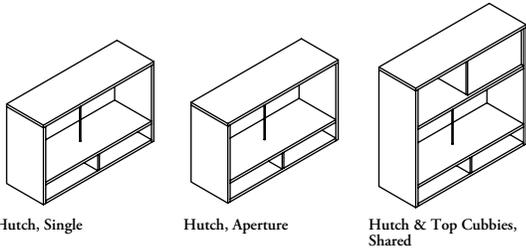

Hutch, Single

Hutch, Aperture

Hutch & Top Cubbies, Shared

## H T S H N K Open Through Hutch Stacker with Sliding Door Overhead

Page 436

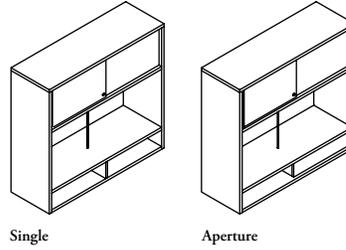

Single

Aperture

## H T S H S Solid Back Hutch Stacker

Page 438

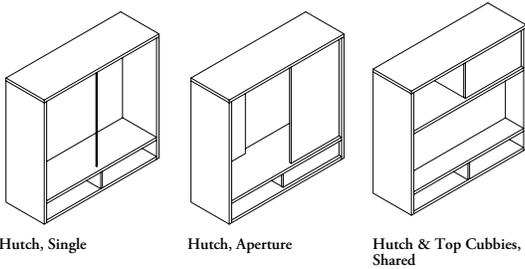

Hutch, Single

Hutch, Aperture

Hutch & Top Cubbies, Shared

## H T S H S K Solid Back Hutch Stacker with Sliding Door Overhead

Page 440

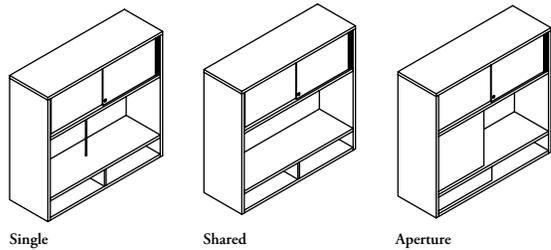

Single

Shared

Aperture

## H T S H G Glass Back Hutch Stacker

Page 442

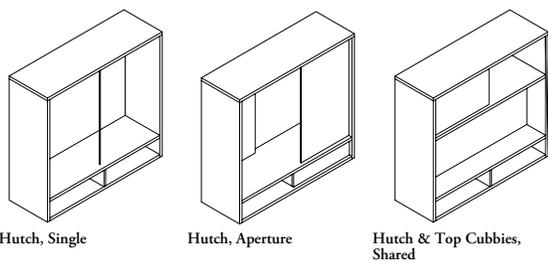

Hutch, Single

Hutch, Aperture

Hutch & Top Cubbies, Shared

## H T S H G K Glass Back Hutch Stacker with Sliding Door Overhead

Page 446

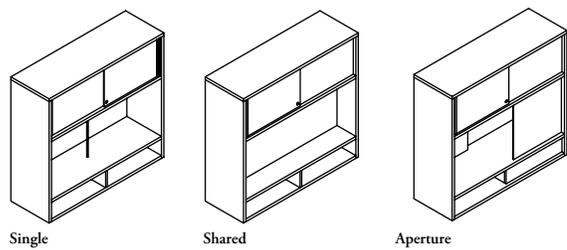

Single

Shared

Aperture

## H T S H P Perforated Hutch Stacker

Page 450

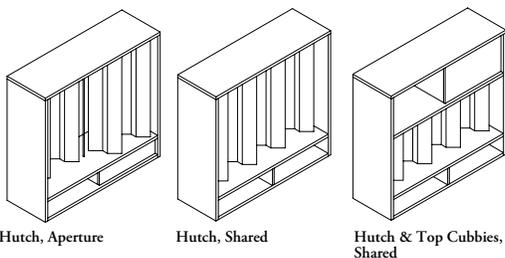

Hutch, Aperture

Hutch, Shared

Hutch & Top Cubbies, Shared

## H T S H P K Perforated Hutch Stacker with Sliding Door Overhead

Page 452

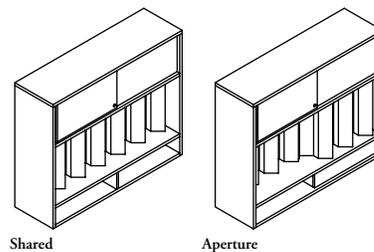

Shared

Aperture

## product map

### H T S H E Elevated Hutch Stacker

Page 454

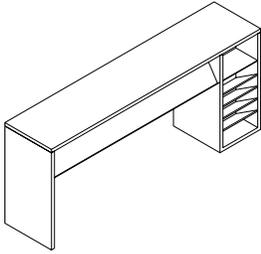

### H T A H Hutch Fascia Add-On

Page 456

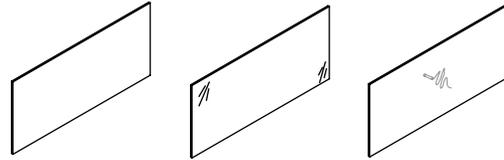

Fabric

Back-Painted Glass

Whiteboard

---

### H T A V Hutch Overhead Fascia Add-On

Page 462

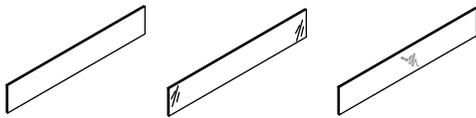

Fabric

Back-Painted Glass

Whiteboard

### H T H A Hutch Accessory

Page 464

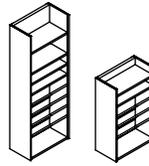



# hutch stackers & accessories

## HTSHN

### Open Through Hutch Stacker

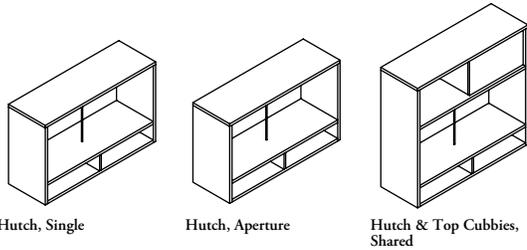

Hutch, Single

Hutch, Aperture

Hutch & Top Cubbies, Shared

#### WHAT'S INCLUDED

Case, rod (if necessary), double face tape.

#### WHAT'S EXCLUDED

Fascia Add-Ons, see *Storage Accessories* section.

#### NOTES

Configuration Hutch and Top Cubbies (J), is only available in heights 30" and 45".

Configuration Hutch (H), is only available in heights 21" and 30".

Handedness is available on styles Shared (D) and Aperture (Y) except for when configuration Hutch (H) and style Shared (D) are specified together.

#### PRODUCT OPTIONS

Configuration	Style	Height	Width	Handedness	Case & Secondary Finish	Secondary Finish Application
<b>H</b> Hutch	<b>S</b> Single	21, 30, 45	30, 36, 42, 48, 54, 60, 66, 72	<b>N</b> Not Applicable	Source Laminate	<b>A</b> Shelves
<b>J</b> Hutch & Top Cubbies	<b>D</b> Shared <b>Y</b> Aperture			<b>L</b> Left <b>R</b> Right	Flintwood Veneer	<b>B</b> Back <b>C</b> Shelves & Back

#### SAMPLE ORDER CODE

<b>HTSHN H</b>	<b>D</b>	<b>30</b>	<b>30</b>	<b>N</b>	<b>ZA</b>	<b>ZA</b>	<b>A</b>
----------------	----------	-----------	-----------	----------	-----------	-----------	----------

#### DIMENSIONS INCHES / MM

H	W
21 / 533	30 / 762
21 / 533	36 / 914
21 / 533	42 / 1066
21 / 533	48 / 1219
21 / 533	54 / 1372
21 / 533	60 / 1524
21 / 533	66 / 1676
21 / 533	72 / 1829
30 / 762	30 / 762
30 / 762	36 / 914
30 / 762	42 / 1066
30 / 762	48 / 1219
30 / 762	54 / 1372
30 / 762	60 / 1524
30 / 762	66 / 1676
30 / 762	72 / 1829

#### PRICING

HUTCH (H)			SHARED (D)		
SINGLE (S)					
Source Laminate	Flintwood	Veneer	Source Laminate	Flintwood	Veneer
928	2782	2922	928	2442	2566
975	2951	3097	975	2590	2720
1098	3146	3305	1207	2835	2977
1158	3345	3511	1267	3082	3236
1230	3542	3719	1340	3328	3494
1310	3739	3926	1419	3572	3751
1388	3937	4133	1498	3818	4010
1466	4134	4341	1575	4061	4264
991	2913	3059	991	2574	2703
1039	3087	3244	1039	2727	2866
1163	3285	3449	1272	2975	3125
1223	3482	3658	1332	3219	3382
1299	3679	3863	1409	3466	3639
1379	3878	4070	1490	3712	3896
1462	4075	4280	1572	3957	4156
1539	4273	4487	1648	4202	4413

Pricing is continued on the following page.



**H T S H N**  
**Open Through Hutch Stacker**  
**(Continued)**

**DIMENSIONS**  
**INCHES / MM**

H	W
21 / 533	30 / 762
21 / 533	36 / 914
21 / 533	42 / 1066
21 / 533	48 / 1219
21 / 533	54 / 1372
21 / 533	60 / 1524
21 / 533	66 / 1676
21 / 533	72 / 1829
30 / 762	30 / 762
30 / 762	36 / 914
30 / 762	42 / 1066
30 / 762	48 / 1219
30 / 762	54 / 1372
30 / 762	60 / 1524
30 / 762	66 / 1676
30 / 762	72 / 1829

**PRICING**

<b>HUTCH (H) (Continued)</b>			
<b>APERTURE (Y)</b>			
Source Laminate	Flintwood	Veneer	
1058	2718	2853	
1112	2882	3023	
1167	3054	3206	
1228	3256	3419	
1305	3460	3631	
1387	3664	3846	
1470	3867	4059	
1549	4069	4273	
1112	2853	2998	
1167	3023	3177	
1226	3206	3366	
1289	3419	3592	
1370	3631	3812	
1457	3846	4040	
1544	4059	4262	
1626	4273	4487	

H	W
30 / 762	30 / 762
30 / 762	36 / 914
30 / 762	42 / 1066
30 / 762	48 / 1219
30 / 762	54 / 1372
30 / 762	60 / 1524
30 / 762	66 / 1676
30 / 762	72 / 1829
45 / 1143	30 / 762
45 / 1143	36 / 914
45 / 1143	42 / 1066
45 / 1143	48 / 1219
45 / 1143	54 / 1372
45 / 1143	60 / 1524
45 / 1143	66 / 1676
45 / 1143	72 / 1829

<b>HUTCH &amp; TOP CUBBIES (J)</b>						
<b>SINGLE (S)</b>			<b>SHARED (D)</b>			
Source Laminate	Flintwood	Veneer	Source Laminate	Flintwood	Veneer	
1213	4030	4233	1144	3517	3692	
1276	4273	4487	1202	3727	3916	
1338	4553	4781	1459	4054	4258	
1415	4833	5076	1536	4383	4603	
1508	5116	5371	1627	4710	4947	
1605	5396	5667	1726	5038	5291	
1705	5677	5961	1826	5364	5634	
1800	5959	6257	1921	5696	5980	
1357	4352	4572	1357	3835	4027	
1423	4613	4846	1423	4068	4269	
1573	4908	5153	1701	4416	4639	
1667	5199	5463	1791	4767	5005	
1778	5496	5770	1904	5116	5371	
1896	5790	6079	2021	5466	5735	
2016	6084	6389	2139	5814	6104	
2131	6379	6697	2257	6161	6470	

Pricing is continued on the following page.

## H T S H N

### Open Through Hutch Stacker (Continued)

#### DIMENSIONS INCHES / MM

H	W
21 / 533	30 / 762
30 / 762	30 / 762
30 / 762	36 / 914
30 / 762	42 / 1066
30 / 762	48 / 1219
30 / 762	54 / 1372
30 / 762	60 / 1524
30 / 762	66 / 1676
30 / 762	72 / 1829
45 / 1143	30 / 762
45 / 1143	36 / 914
45 / 1143	42 / 1066
45 / 1143	48 / 1219
45 / 1143	54 / 1372
45 / 1143	60 / 1524
45 / 1143	66 / 1676
45 / 1143	72 / 1829

#### PRICING

#### HUTCH & TOP CUBBIES (J) (Continued)

#### APERTURE (Y)

Source Laminate	Flintwood	Veneer
1058	2718	2853
1278	3952	4145
1339	4187	4397
1408	4438	4660
1489	4743	4979
1587	5046	5298
1689	5350	5618
1795	5655	5937
1897	5959	6257
1575	4282	4496
1654	4540	4767
1737	4812	5054
1797	5123	5379
1883	5437	5708
1973	5752	6039
2067	6063	6365
2154	6379	6697



# hutch stackers & accessories

## HTSHNK

### Open Through Hutch Stacker with Sliding Door Overhead

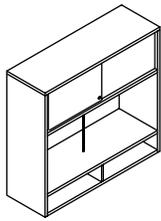

Single

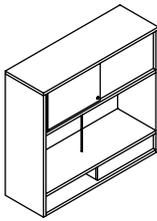

Aperture

#### WHAT'S INCLUDED

Case, sliding door with hardware, lock and keys (if specified), rod (if necessary), double face tape.

#### WHAT'S EXCLUDED

Fascia add-ons, see *Storage Accessories* section.

#### NOTES

Style Shared (D) and Aperture (Y), are only available in widths 42" - 72".

Handedness Left (L) or Right (R) must be specified if style Shared (D) or Aperture (Y) is selected.

#### PRODUCT OPTIONS

Style	Height	Width	Handedness	Case & Secondary Finish	Door Finish	Handle Finish	Key
S Single	45	30, 36, 42, 48, 54, 60, 66, 72	N Not Applicable	Source Laminate	Source Laminate	Foundation Mica	N No Key
D Shared			L Left	Flintwood	Flintwood		K Key Alike
Y Aperture			R Right	Veneer	Veneer Glass Frosted Glass Back-Painted Glass		R Key Random

#### SAMPLE ORDER CODE

HTSHNK D	45	48	R	ZA	ZA	ZA	60	N
----------	----	----	---	----	----	----	----	---

#### DIMENSIONS INCHES / MM

H	W
45 / 1143	30 / 762
45 / 1143	36 / 914
45 / 1143	42 / 1066
45 / 1143	48 / 1219
45 / 1143	54 / 1372
45 / 1143	60 / 1524
45 / 1143	66 / 1676
45 / 1143	72 / 1829

#### PRICING

##### SINGLE (S)

##### SOURCE LAMINATE

Case, Secondary & Front	Case, Secondary & Flintwood Front	Case, Secondary & Clear Glass Front	Case, Secondary & Frosted Glass Front	Case, Secondary & Glass BP Front
1538	1635	1538	1642	1838
1779	1884	1769	1879	2086
2076	2185	2055	2172	2391
2184	2303	2154	2277	2510
2317	2441	2277	2407	2650
2458	2588	2405	2539	2799
2616	2760	2532	2673	2946
2732	2876	2646	2790	3060

##### FLINTWOOD

Case, Secondary & Front	Case, Secondary & Clear Glass Front	Case, Secondary & Frosted Glass Front	Case, Secondary & Glass BP Front	Case, Secondary & Clear Glass Front	Case, Secondary & Frosted Glass Front	Case, Secondary & Glass BP Front
4720	4620	4727	4921	4955	4833	4940
5050	4935	5042	5250	5302	5165	5273
5379	5248	5364	5587	5649	5493	5611
5709	5560	5684	5918	5996	5823	5943
6043	5879	6005	6251	6344	6152	6280
6442	6260	6394	6654	6763	6553	6688
6841	6611	6756	7027	7184	6927	7065
7239	7014	7156	7428	7602	7346	7486

Pricing is continued on the following page.

**HTSHNK**

**Open Through Hutch Stacker with Sliding Door Overhead (Continued)**

**DIMENSIONS  
INCHES / MM**

**PRICING**

**SHARED (D)**

**SOURCE LAMINATE**

H	W	Case, Secondary & Front	Case, Secondary & Flintwood Front	Case, Secondary & Clear Glass Front	Case, Secondary & Frosted Glass Front	Case, Secondary & Glass BP Front
45 / 1143	42 / 1066	1957	2074	1914	2019	2214
45 / 1143	48 / 1219	2049	2164	2012	2110	2310
45 / 1143	54 / 1372	2161	2274	2123	2223	2420
45 / 1143	60 / 1524	2311	2433	2257	2374	2598
45 / 1143	66 / 1676	2461	2592	2390	2529	2775
45 / 1143	72 / 1829	2604	2748	2521	2675	2965

**FLINTWOOD**

**VENEER**

H	W	Case, Secondary & Front	Case, Secondary & Clear Glass Front	Case, Secondary & Frosted Glass Front	Case, Secondary & Glass BP Front	Case, Secondary & Front	Case, Secondary & Clear Glass Front	Case, Secondary & Frosted Glass Front	Case, Secondary & Glass BP Front
45 / 1143	42 / 1066	5952	5798	5900	6097	6251	6067	6174	6368
45 / 1143	48 / 1219	6280	6129	6229	6425	6597	6419	6518	6716
45 / 1143	54 / 1372	6608	6456	6556	6756	6938	6762	6864	7059
45 / 1143	60 / 1524	6970	6794	6912	7136	7320	7114	7234	7457
45 / 1143	66 / 1676	7330	7131	7267	7513	7698	7467	7605	7852
45 / 1143	72 / 1829	7691	7465	7621	7910	8075	7817	7974	8265

**APERTURE (Y)**

**SOURCE LAMINATE**

H	W	Case, Secondary & Front	Case, Secondary & Flintwood Front	Case, Secondary & Clear Glass Front	Case, Secondary & Frosted Glass Front	Case, Secondary & Glass BP Front
45 / 1143	42 / 1066	1957	2074	1914	2019	2214
45 / 1143	48 / 1219	2049	2164	2012	2110	2310
45 / 1143	54 / 1372	2161	2274	2123	2223	2420
45 / 1143	60 / 1524	2311	2433	2257	2374	2598
45 / 1143	66 / 1676	2461	2592	2390	2529	2775
45 / 1143	72 / 1829	2604	2748	2521	2675	2965

**FLINTWOOD**

**VENEER**

H	W	Case, Secondary & Front	Case, Secondary & Clear Glass Front	Case, Secondary & Frosted Glass Front	Case, Secondary & Glass BP Front	Case, Secondary & Front	Case, Secondary & Clear Glass Front	Case, Secondary & Frosted Glass Front	Case, Secondary & Glass BP Front
45 / 1143	42 / 1066	5756	5599	5704	5900	6044	5861	5966	6164
45 / 1143	48 / 1219	6110	5959	6058	6254	6417	6238	6338	6535
45 / 1143	54 / 1372	6466	6311	6412	6608	6787	6608	6711	6907
45 / 1143	60 / 1524	6893	6716	6835	7056	7237	7033	7149	7374
45 / 1143	66 / 1676	7320	7116	7255	7503	7684	7455	7593	7839
45 / 1143	72 / 1829	7747	7520	7677	7967	8135	7878	8033	8323

# hutch stackers & accessories

## HTSHS

### Solid Back Hutch Stacker

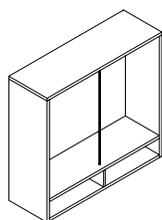

Hutch, Single

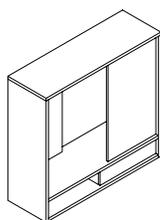

Hutch, Aperture

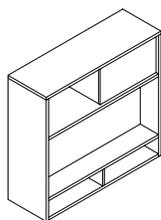

Hutch & Top Cubbies, Shared

#### WHAT'S INCLUDED

Case, rod (if necessary), double face tape.

#### WHAT'S EXCLUDED

Fascia add-ons, see *Storage Accessories* section.

#### NOTES

Configuration Hutch and Top Cubbies (J), is only available in heights 30" and 45".

Handedness is available on styles Shared (D) and Aperture (Y) except for when configuration Hutch (H) and style Shared (D) are specified together.

Style Aperture (Y) is only available in widths 42" - 72" and heights 30" and 45".

#### PRODUCT OPTIONS

Configuration	Style	Height	Width	Handedness	Case & Secondary Finish	Secondary Finish Application
<b>H</b> Hutch	<b>S</b> Single	21, 30, 45	30, 36, 42, 48, 54, 60, 66, 72	<b>N</b> Not Applicable	Source Laminate	<b>A</b> Shelves
<b>J</b> Hutch & Top Cubbies	<b>D</b> Shared <b>Y</b> Aperture			<b>L</b> Left <b>R</b> Right	Flintwood Veneer	<b>B</b> Back <b>C</b> Shelves & Back

#### SAMPLE ORDER CODE

<b>HTSHS H</b>	<b>D</b>	<b>45</b>	<b>30</b>	<b>N</b>	<b>ZA</b>	<b>ZA</b>	<b>A</b>
----------------	----------	-----------	-----------	----------	-----------	-----------	----------

#### DIMENSIONS INCHES / MM

H	W
21 / 533	30 / 762
21 / 533	36 / 914
21 / 533	42 / 1066
21 / 533	48 / 1219
21 / 533	54 / 1372
21 / 533	60 / 1524
21 / 533	66 / 1676
21 / 533	72 / 1829
30 / 762	30 / 762
30 / 762	36 / 914
30 / 762	42 / 1066
30 / 762	48 / 1219
30 / 762	54 / 1372
30 / 762	60 / 1524
30 / 762	66 / 1676
30 / 762	72 / 1829
45 / 1143	30 / 762
45 / 1143	36 / 914
45 / 1143	42 / 1066
45 / 1143	48 / 1219
45 / 1143	54 / 1372
45 / 1143	60 / 1524
45 / 1143	66 / 1676
45 / 1143	72 / 1829

#### PRICING

HUTCH (H)			SHARED (D)		
SINGLE (S)					
Source Laminate	Flintwood	Veneer	Source Laminate	Flintwood	Veneer
1024	2832	2975	1024	2796	2936
1076	3098	3254	1076	3098	3254
1253	3366	3535	1142	3400	3570
1328	3630	3811	1218	3705	3890
1418	3896	4091	1309	4008	4208
1513	4164	4371	1406	4310	4525
1610	4429	4650	1499	4612	4845
1702	4695	4928	1594	4914	5161
1127	3131	3286	1127	3110	3267
1182	3418	3591	1182	3418	3591
1366	3707	3892	1257	3724	3911
1448	3993	4193	1339	4030	4233
1550	4282	4497	1439	4340	4556
1655	4571	4799	1544	4646	4880
1761	4857	5101	1651	4952	5199
1862	5149	5406	1751	5259	5523
1260	3888	4080	1260	3849	4043
1326	4262	4474	1326	4262	4474
1516	4640	4872	1408	4676	4908
1610	5012	5266	1499	5089	5343
1723	5391	5658	1614	5499	5776
1840	5765	6055	1728	5913	6209
1959	6142	6449	1847	6324	6641
2074	6516	6841	1961	6735	7072

Pricing is continued on the following page.

## H T S H S Solid Back Hutch Stacker (Continued)

**DIMENSIONS  
INCHES / MM**

H	W
30 / 762	42 / 1066
30 / 762	48 / 1219
30 / 762	54 / 1372
30 / 762	60 / 1524
30 / 762	66 / 1676
30 / 762	72 / 1829
45 / 1143	42 / 1066
45 / 1143	48 / 1219
45 / 1143	54 / 1372
45 / 1143	60 / 1524
45 / 1143	66 / 1676
45 / 1143	72 / 1829

**PRICING**

<b>HUTCH (H) (Continued)</b>		
<b>APERTURE (Y)</b>		
Source Laminate	Flintwood	Veneer
1318	4141	4349
1408	4377	4595
1512	4613	4846
1621	4851	5093
1731	5223	5485
1840	5597	5879
1547	4594	4827
1651	4949	5197
1775	5305	5572
1903	5659	5943
2032	6016	6317
2160	6374	6694

<b>HUTCH &amp; TOP CUBBIES (J)</b>						
<b>SINGLE (S)</b>			<b>SHARED (D)</b>			
Source Laminate	Flintwood	Veneer	Source Laminate	Flintwood	Veneer	
1241	3712	3896	1241	4397	4615	
1302	4084	4291	1302	4733	4971	
1500	4461	4683	1381	5069	5326	
1595	4833	5076	1474	5409	5679	
1705	5211	5469	1587	5749	6035	
1820	5584	5861	1700	6085	6390	
1936	5959	6257	1816	6423	6746	
2048	6328	6644	1927	6762	7102	
1449	4246	4459	1449	4875	5117	
1522	4620	4852	1522	5238	5498	
1746	5000	5246	1618	5601	5883	
1850	5373	5643	1726	5965	6264	
1981	5750	6035	1853	6329	6645	
2116	6124	6428	1989	6694	7028	
2254	6501	6824	2127	7057	7410	
2382	6875	7218	2257	7418	7789	

<b>APERTURE (Y)</b>		
Source Laminate	Flintwood	Veneer
1449	5050	5301
1547	5397	5667
1663	5748	6032
1784	6094	6397
1907	6442	6763
2022	6793	7134
1780	5575	5855
1898	5968	6267
2041	6360	6679
2187	6752	7089
2340	7143	7503
2481	7536	7915

# hutch stackers & accessories

## HTSHSK

### Solid Back Hutch Stacker with Sliding Door Overhead

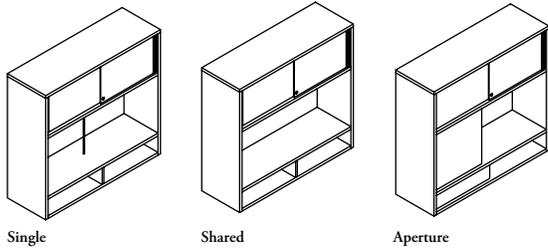

Single

Shared

Aperture

#### WHAT'S INCLUDED

Case, sliding door with hardware, lock and keys (if specified), rod (if necessary), double face tape.

#### WHAT'S EXCLUDED

Fascia add-ons, see *Storage Accessories* section.

#### NOTES

Handedness Left (L) or Right (R) must be specified if Style Shared (D) or Aperture (Y) are selected.

Style Shared (D) and Aperture (Y) are only available in widths 42" - 72".

#### PRODUCT OPTIONS

Style	Height	Width	Handedness	Case & Secondary Finish	Door Finish	Handle Finish	Key
S Single	45	30, 36, 42, 48, 54, 60, 66, 72	N Not Applicable	Source Laminate	Source Laminate	Foundation Mica	N No Key
D Shared			L Left	Flintwood	Flintwood		K Key Alike
Y Aperture			R Right	Veneer	Veneer Glass Frosted Glass Back-Painted Glass		R Key Random

#### SAMPLE ORDER CODE

<b>HTSHSK D</b>	<b>45</b>	<b>48</b>	<b>R</b>	<b>ZA</b>	<b>ZA</b>	<b>ZA</b>	<b>60</b>	<b>N</b>
-----------------	-----------	-----------	----------	-----------	-----------	-----------	-----------	----------

#### DIMENSIONS INCHES / MM

H	W
45 / 1143	30 / 762
45 / 1143	36 / 914
45 / 1143	42 / 1066
45 / 1143	48 / 1219
45 / 1143	54 / 1372
45 / 1143	60 / 1524
45 / 1143	66 / 1676
45 / 1143	72 / 1829

#### PRICING

##### SINGLE (S)

##### SOURCE LAMINATE

Case, Secondary & Front	Case, Secondary & Flintwood Front	Case, Secondary & Clear Glass Front	Case, Secondary & Frosted Glass Front	Case, Secondary & Glass BP Front
1780	1879	1780	1884	2079
1877	1983	1869	1978	2185
2117	2230	2100	2214	2435
2244	2364	2213	2338	2570
2394	2521	2355	2483	2727
2551	2680	2498	2631	2893
2726	2871	2643	2785	3057
2857	3004	2773	2916	3188

##### FLINTWOOD

Case, Secondary & Front	Case, Secondary & Clear Glass Front	Case, Secondary & Frosted Glass Front	Case, Secondary & Glass BP Front	Case, Secondary & Front	Case, Secondary & Clear Glass Front	Case, Secondary & Frosted Glass Front	Case, Secondary & Glass BP Front
5145	5045	5150	5346	5401	5280	5387	5582
5539	5423	5531	5738	5814	5677	5785	5994
5933	5800	5916	6138	6227	6070	6187	6410
6324	6176	6298	6531	6641	6468	6590	6823
6719	6553	6683	6929	7054	6863	6990	7235
7112	6930	7063	7323	7467	7255	7389	7650
7505	7276	7418	7690	7880	7622	7763	8036
7896	7671	7812	8084	8293	8035	8176	8449

##### VENER

Pricing is continued on the following page.



## H T S H S K Solid Back Hutch Stacker with Sliding Door Overhead (Continued)

**DIMENSIONS  
INCHES / MM**

H	W
45 / 1143	42 / 1066
45 / 1143	48 / 1219
45 / 1143	54 / 1372
45 / 1143	60 / 1524
45 / 1143	66 / 1676
45 / 1143	72 / 1829

**PRICING**

**SHARED (D)**

**SOURCE LAMINATE**

	Case, Secondary & Front	Case, Secondary & Flintwood Front	Case, Secondary & Clear Glass Front	Case, Secondary & Frosted Glass Front	Case, Secondary & Glass BP Front
	1907	2021	1866	1968	2166
	2001	2116	1961	2061	2259
	2108	2224	2073	2172	2371
	2267	2391	2214	2334	2555
	2433	2566	2365	2501	2749
	2601	2745	2516	2673	2962

**FLINTWOOD**

	Case, Secondary & Front	Case, Secondary & Clear Glass Front	Case, Secondary & Frosted Glass Front	Case, Secondary & Glass BP Front
	6569	6411	6516	6713
	6994	6841	6938	7139
	7419	7268	7369	7566
	7833	7655	7775	7997
	8247	8046	8183	8430
	8661	8434	8590	8879

**VENEER**

	Case, Secondary & Front	Case, Secondary & Clear Glass Front	Case, Secondary & Frosted Glass Front	Case, Secondary & Glass BP Front
	6897	6714	6817	7015
	7346	7168	7265	7464
	7790	7613	7714	7911
	8225	8023	8143	8363
	8660	8429	8567	8813
	9096	8836	8992	9281

**APERTURE (Y)**

**SOURCE LAMINATE**

	Case, Secondary & Front	Case, Secondary & Flintwood Front	Case, Secondary & Clear Glass Front	Case, Secondary & Frosted Glass Front	Case, Secondary & Glass BP Front
	2163	2281	2122	2224	2421
	2283	2396	2243	2343	2540
	2423	2539	2386	2487	2682
	2601	2725	2549	2667	2889
	2782	2916	2715	2852	3098
	2956	3100	2873	3028	3316

**FLINTWOOD**

	Case, Secondary & Front	Case, Secondary & Clear Glass Front	Case, Secondary & Frosted Glass Front	Case, Secondary & Glass BP Front
	7028	6870	6974	7171
	7483	7329	7430	7628
	7939	7787	7888	8088
	8384	8205	8324	8547
	8826	8625	8761	9009
	9267	9041	9197	9486

**VENEER**

	Case, Secondary & Front	Case, Secondary & Clear Glass Front	Case, Secondary & Frosted Glass Front	Case, Secondary & Glass BP Front
	7380	7196	7299	7497
	7858	7681	7779	7978
	8339	8159	8262	8456
	8804	8600	8717	8939
	9267	9037	9173	9421
	9732	9472	9628	9918

# hutch stackers & accessories

## HTSHG

### Glass Back Hutch Stacker

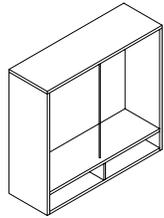

Hutch, Single

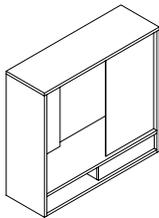

Hutch, Aperture

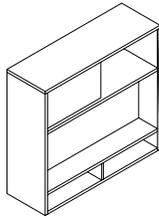

Hutch & Top Cubbies, Shared

#### WHAT'S INCLUDED

Case, glass back with hardware, rod (if necessary), double face tape.

#### WHAT'S EXCLUDED

Fascia add-ons, see *Storage Accessories* section.

#### NOTES

Configuration Hutch and Top Cubbies (J), is only available in heights 30" and 45".

Style Aperture (Y) is only available in widths 42" - 72" and heights 30" and 45".

Handedness is available on styles Shared (D) and Aperture (Y) except for when configuration Hutch (H) and style Shared (D) are specified together.

Support Rod is only required for Style (S) type hutches.

#### PRODUCT OPTIONS

Configuration	Style	Height	Width	Handedness	Case & Secondary Finish	Secondary Finish Application	Hutch Glass Finish
<b>H</b> Hutch	<b>S</b> Single	21, 30, 45	30, 36, 42, 48, 54, 60, 66, 72	<b>N</b> Not Applicable	Source Laminate	<b>A</b> Shelves	<b>CL</b> Clear Glass
<b>J</b> Hutch & Top Cubbies	<b>D</b> Shared			<b>L</b> Left	Flintwood	<b>B</b> Back	<b>FT</b> Frosted Glass
	<b>Y</b> Aperture			<b>R</b> Right	Veneer	<b>C</b> Shelves & Back	

#### SAMPLE ORDER CODE

<b>HTSHG H</b>	<b>D</b>	<b>45</b>	<b>30</b>	<b>N</b>	<b>ZA</b>	<b>ZA</b>	<b>A</b>	<b>FT</b>
----------------	----------	-----------	-----------	----------	-----------	-----------	----------	-----------

#### DIMENSIONS INCHES / MM

#### PRICING

		HUTCH (H)			HUTCH (H)		
		SINGLE (S)			SINGLE (S)		
		CLEAR GLASS (CL)			FROSTED GLASS (FT)		
H	W	Source Laminate	Flintwood	Veneer	Source Laminate	Flintwood	Veneer
21 / 533	30 / 762	1105	2530	2654	1216	2641	2765
21 / 533	36 / 914	1161	2682	2812	1275	2796	2926
21 / 533	42 / 1066	1348	2943	3084	1478	3074	3216
21 / 533	48 / 1219	1436	3202	3357	1588	3354	3509
21 / 533	54 / 1372	1534	3459	3625	1705	3631	3798
21 / 533	60 / 1524	1643	3721	3899	1830	3908	4085
21 / 533	66 / 1676	1747	3977	4168	1956	4187	4378
21 / 533	72 / 1829	1850	4236	4439	2078	4465	4667
30 / 762	30 / 762	1248	2701	2831	1429	2882	3012
30 / 762	36 / 914	1308	2861	3000	1500	3054	3193
30 / 762	42 / 1066	1508	3128	3279	1730	3351	3501
30 / 762	48 / 1219	1609	3394	3556	1856	3641	3804
30 / 762	54 / 1372	1728	3664	3836	2003	3939	4111
30 / 762	60 / 1524	1840	3924	4108	2147	4231	4415
30 / 762	66 / 1676	1966	4191	4391	2299	4526	4724
30 / 762	72 / 1829	2081	4454	4665	2446	4819	5030

Pricing is continued on the following page.

# H T S H G

## Glass Back Hutch Stacker (Continued)

**DIMENSIONS  
INCHES / MM**

H	W
45 / 1143	30 / 762
45 / 1143	36 / 914
45 / 1143	42 / 1066
45 / 1143	48 / 1219
45 / 1143	54 / 1372
45 / 1143	60 / 1524
45 / 1143	66 / 1676
45 / 1143	72 / 1829

H	W
21 / 533	30 / 762
21 / 533	36 / 914
21 / 533	42 / 1066
21 / 533	48 / 1219
21 / 533	54 / 1372
21 / 533	60 / 1524
21 / 533	66 / 1676
21 / 533	72 / 1829
30 / 762	30 / 762
30 / 762	36 / 914
30 / 762	42 / 1066
30 / 762	48 / 1219
30 / 762	54 / 1372
30 / 762	60 / 1524
30 / 762	66 / 1676
30 / 762	72 / 1829
45 / 1143	30 / 762
45 / 1143	36 / 914
45 / 1143	42 / 1066
45 / 1143	48 / 1219
45 / 1143	54 / 1372
45 / 1143	60 / 1524
45 / 1143	66 / 1676
45 / 1143	72 / 1829

**PRICING**

**HUTCH (H) (CONTINUED)**  
**SINGLE (S) (CONTINUED)**

CLEAR GLASS (CL)			FROSTED GLASS (FT)		
Source Laminate	Flintwood	Veneer	Source Laminate	Flintwood	Veneer
1445	3026	3167	1728	3308	3451
1519	3208	3357	1814	3504	3652
1734	3505	3670	2078	3848	4014
1853	3806	3982	2249	4203	4378
1990	4105	4299	2435	4551	4745
2131	4407	4612	2622	4899	5105
2273	4707	4925	2816	5249	5467
2413	5005	5237	3005	5597	5829

**SHARED (D)**  
**CLEAR GLASS (CL)**

Source Laminate	Flintwood	Veneer	FROSTED GLASS (FT)		
Source Laminate	Flintwood	Veneer	Source Laminate	Flintwood	Veneer
1105	2871	3010	1216	2982	3120
1161	3042	3189	1275	3156	3304
1237	3253	3412	1369	3384	3543
1326	3465	3631	1477	3617	3783
1422	3674	3849	1595	3846	4022
1534	3888	4075	1720	4075	4262
1635	4096	4292	1845	4306	4502
1740	4309	4517	1968	4536	4744
1248	3041	3187	1429	3222	3367
1308	3221	3377	1500	3413	3570
1398	3440	3603	1620	3661	3826
1499	3656	3833	1747	3904	4080
1618	3878	4060	1892	4152	4336
1731	4090	4282	2036	4396	4588
1859	4310	4514	2192	4643	4849
1972	4527	4740	2336	4891	5105
1445	3399	3561	1728	3682	3843
1519	3601	3772	1814	3896	4067
1625	3847	4031	1968	4190	4375
1742	4097	4286	2139	4493	4683
1881	4342	4545	2326	4789	4991
2022	4589	4801	2514	5082	5294
2162	4836	5061	2705	5378	5603
2303	5085	5321	2895	5677	5913

Pricing is continued on the following page.

# hutch stackers & accessories

## H T S H G

### Glass Back Hutch Stacker (Continued)

#### DIMENSIONS INCHES / MM

H	W
30 / 762	42 / 1066
30 / 762	48 / 1219
30 / 762	54 / 1372
30 / 762	60 / 1524
30 / 762	66 / 1676
30 / 762	72 / 1829
45 / 1143	42 / 1066
45 / 1143	48 / 1219
45 / 1143	54 / 1372
45 / 1143	60 / 1524
45 / 1143	66 / 1676
45 / 1143	72 / 1829

#### PRICING

#### HUTCH (H) (CONTINUED)

##### APERTURE (Y)

##### CLEAR GLASS (CL)

Source Laminate	Flintwood	Veneer
1433	3347	3508
1550	3587	3759
1689	3829	4010
1822	4066	4259
1968	4308	4510
2089	4541	4754
1814	3784	3962
1858	4050	4241
1918	4317	4513
1986	4580	4791
2051	4846	5067
2117	5110	5347

##### FROSTED GLASS (FT)

Source Laminate	Flintwood	Veneer
1673	3587	3747
1818	3856	4028
1981	4121	4301
2147	4390	4583
2318	4657	4859
2476	4927	5140
2156	4127	4304
2252	4444	4635
2360	4760	4956
2477	5071	5282
2593	5388	5610
2709	5701	5937

#### HUTCH & TOP CUBBIES (J)

##### SINGLE (S)

##### CLEAR GLASS (CL)

Source Laminate	Flintwood	Veneer
1321	3605	3780
1385	3818	4007
1598	4161	4366
1702	4503	4723
1818	4842	5078
1948	5186	5439
2071	5523	5793
2194	5870	6155
1534	3923	4114
1607	4159	4361
1838	4523	4746
1960	4887	5125
2094	5248	5502
2245	5614	5884
2388	5973	6264
2532	6336	6644

##### FROSTED GLASS (FT)

Source Laminate	Flintwood	Veneer
1432	3715	3890
1499	3933	4122
1726	4289	4493
1844	4645	4866
1978	5001	5237
2119	5357	5611
2255	5708	5978
2390	6066	6350
1644	4034	4226
1723	4273	4475
1969	4655	4878
2109	5037	5275
2266	5420	5674
2432	5801	6071
2596	6182	6472
2760	6563	6872

Pricing is continued on the following page.

## H T S H G Glass Back Hutch Stacker (Continued)

**DIMENSIONS  
INCHES / MM**

H	W
30 / 762	30 / 762
30 / 762	36 / 914
30 / 762	42 / 1066
30 / 762	48 / 1219
30 / 762	54 / 1372
30 / 762	60 / 1524
30 / 762	66 / 1676
30 / 762	72 / 1829
45 / 1143	30 / 762
45 / 1143	36 / 914
45 / 1143	42 / 1066
45 / 1143	48 / 1219
45 / 1143	54 / 1372
45 / 1143	60 / 1524
45 / 1143	66 / 1676
45 / 1143	72 / 1829

H	W
30 / 762	42 / 1066
30 / 762	48 / 1219
30 / 762	54 / 1372
30 / 762	60 / 1524
30 / 762	66 / 1676
30 / 762	72 / 1829
45 / 1143	42 / 1066
45 / 1143	48 / 1219
45 / 1143	54 / 1372
45 / 1143	60 / 1524
45 / 1143	66 / 1676
45 / 1143	72 / 1829

**PRICING**

**HUTCH & TOP CUBBIES (J) (CONTINUED)**

**SHARED (D)**

**CLEAR GLASS (CL)**

Source Laminate	Flintwood	Veneer
1321	4119	4321
1385	4366	4579
1477	4661	4888
1581	4954	5196
1700	5248	5502
1828	5544	5815
1951	5836	6120
2077	6133	6431
1534	4440	4660
1607	4706	4938
1712	5015	5260
1835	5320	5584
1969	5627	5900
2117	5938	6228
2262	6243	6548
2404	6554	6872

**FROSTED GLASS (FT)**

Source Laminate	Flintwood	Veneer
1432	4229	4431
1499	4480	4693
1609	4792	5019
1731	5103	5346
1871	5420	5674
2014	5731	6002
2160	6044	6329
2272	6329	6627
1644	4551	4770
1723	4820	5053
1844	5146	5392
1983	5469	5733
2141	5800	6073
2305	6125	6415
2471	6451	6757
2632	6782	7101

**APERTURE (Y)**

**CLEAR GLASS (CL)**

Source Laminate	Flintwood	Veneer
1504	4523	4745
1626	4850	5086
1761	5170	5423
1908	5496	5763
2048	5816	6099
2359	6227	6524
1833	4897	5139
1937	5230	5486
2057	5561	5832
2192	5897	6184
2321	6224	6526
2616	6646	6965

**FROSTED GLASS (FT)**

Source Laminate	Flintwood	Veneer
1742	4762	4984
1907	5131	5366
2099	5508	5760
2297	5885	6153
2494	6262	6545
3089	6957	7254
2072	5136	5378
2217	5512	5767
2395	5898	6170
2582	6287	6574
2767	6669	6973
3347	7377	7696

# hutch stackers & accessories

## HTSHGK

### Glass Back Hutch Stacker with Sliding Door Overhead

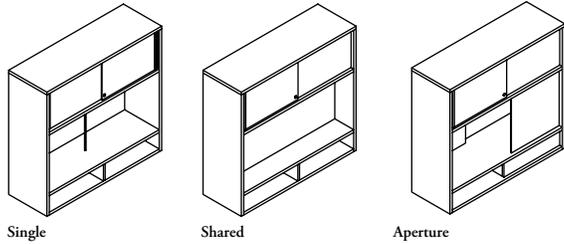

Single

Shared

Aperture

#### WHAT'S INCLUDED

Case, glass back with hardware, sliding door with hardware, lock and keys (if specified), rod (if necessary), double face tape.

#### WHAT'S EXCLUDED

Fascia add-ons, see *Storage Accessories* section.

#### NOTES

Handedness Left (L) or Right (R) must be specified if Style Shared (D) or Aperture (Y) are selected.

Styles Shared (D) and Aperture (Y) are only available in widths 42" - 72".

#### PRODUCT OPTIONS

Style	Height	Width	Handedness	Case & Secondary Finish	Door Finish	Hutch Glass Finish	Handle Finish	Key
S Single	45	30, 36, 42, 48, 54, 60, 66, 72	N Not Applicable L Left R Right	Source Laminate Flintwood Veneer	Source Laminate Flintwood Veneer Glass Frosted Glass Back-Painted Glass	CL Clear Glass FT Frosted Glass	Foundation Mica	N No Key K Key Alike R Key Random
D Shared								
Y Aperture								

#### SAMPLE ORDER CODE

HTSHGK D	45	48	R	ZA	ZA	ZA		FT	60	N
----------	----	----	---	----	----	----	--	----	----	---

#### DIMENSIONS INCHES / MM

H	W
45 / 1143	30 / 762
45 / 1143	36 / 914
45 / 1143	42 / 1066
45 / 1143	48 / 1219
45 / 1143	54 / 1372
45 / 1143	60 / 1524
45 / 1143	66 / 1676
45 / 1143	72 / 1829

#### PRICING

##### WITH CLEAR GLASS HUTCH (CL)

##### SINGLE (S)

##### SOURCE LAMINATE

Case, Secondary & Front	Case, Secondary & Flintwood Front	Case, Secondary & Clear Glass Front	Case, Secondary & Frosted Glass Front	Case, Secondary & Glass BP Front
1773	1871	1773	1877	2074
1870	1976	1862	1971	2179
2106	2219	2086	2205	2424
2231	2349	2201	2322	2558
2378	2501	2338	2466	2712
2532	2662	2478	2614	2875
2705	2847	2619	2762	3034
2832	2976	2748	2889	3162

Pricing is continued on the following page.

**H T S H G K**

**Glass Back Hutch Stacker with Sliding Door Overhead (Continued)**

**DIMENSIONS  
INCHES / MM**

45 / 1143	30 / 762
45 / 1143	36 / 914
45 / 1143	42 / 1066
45 / 1143	48 / 1219
45 / 1143	54 / 1372
45 / 1143	60 / 1524
45 / 1143	66 / 1676
45 / 1143	72 / 1829

45 / 1143	42 / 1066
45 / 1143	48 / 1219
45 / 1143	54 / 1372
45 / 1143	60 / 1524
45 / 1143	66 / 1676
45 / 1143	72 / 1829

H	W
45 / 1143	42 / 1066
45 / 1143	48 / 1219
45 / 1143	54 / 1372
45 / 1143	60 / 1524
45 / 1143	66 / 1676
45 / 1143	72 / 1829

**PRICING**

**WITH CLEAR GLASS HUTCH (CL) (Continued)**

**SINGLE (S) (Continued)**

FLINTWOOD				VENEER			
Case, Secondary & Front	Case, Secondary & Clear Glass Front	Case, Secondary & Frosted Glass Front	Case, Secondary & Glass BP Front	Case, Secondary & Front	Case, Secondary & Clear Glass Front	Case, Secondary & Frosted Glass Front	Case, Secondary & Glass BP Front
4269	4171	4277	4470	4484	4363	4468	4664
4526	4413	4522	4730	4754	4615	4725	4934
4901	4770	4887	5108	5146	4989	5108	5330
5275	5129	5250	5485	5542	5365	5489	5724
5652	5487	5617	5861	5936	5745	5875	6118
6029	5846	5980	6240	6331	6118	6253	6515
6430	6207	6347	6618	6755	6494	6636	6907
6779	6553	6695	6966	7117	6859	7003	7274

**SHARED (D)**

**SOURCE LAMINATE**

Case, Secondary & Front	Case, Secondary & Flintwood Front	Case, Secondary & Clear Glass Front	Case, Secondary & Frosted Glass Front	Case, Secondary & Glass BP Front
1989	2104	1948	2050	2250
2095	2210	2057	2157	2355
2220	2335	2182	2284	2480
2382	2508	2330	2449	2672
2547	2680	2478	2616	2862
2706	2848	2620	2777	3066

FLINTWOOD				VENEER			
Case, Secondary & Front	Case, Secondary & Clear Glass Front	Case, Secondary & Frosted Glass Front	Case, Secondary & Glass BP Front	Case, Secondary & Front	Case, Secondary & Clear Glass Front	Case, Secondary & Frosted Glass Front	Case, Secondary & Glass BP Front
5406	5248	5351	5549	5677	5493	5598	5796
5701	5546	5647	5843	5986	5808	5906	6104
5994	5840	5942	6139	6295	6116	6216	6416
6328	6150	6269	6491	6644	6441	6558	6781
6661	6458	6598	6843	6994	6763	6901	7147
6996	6769	6928	7216	7347	7088	7244	7533

Pricing is continued on the following page.

# hutch stackers & accessories

## H T S H G K

### Glass Back Hutch Stacker with Sliding Door Overhead (Continued)

#### DIMENSIONS INCHES / MM

H	W
45 / 1143	42 / 1066
45 / 1143	48 / 1219
45 / 1143	54 / 1372
45 / 1143	60 / 1524
45 / 1143	66 / 1676
45 / 1143	72 / 1829

#### PRICING

##### WITH CLEAR GLASS HUTCH (CL) (Continued)

##### APERTURE (Y)

##### SOURCE LAMINATE

Case, Secondary & Front	Case, Secondary & Flintwood Front	Case, Secondary & Clear Glass Front	Case, Secondary & Frosted Glass Front	Case, Secondary & Glass BP Front
2132	2245	2087	2192	2389
2212	2328	2176	2272	2471
2317	2433	2282	2380	2579
2461	2585	2408	2525	2748
2602	2735	2536	2672	2920
2826	2968	2741	2898	3187

##### FLINTWOOD

Case, Secondary & Front	Case, Secondary & Clear Glass Front	Case, Secondary & Frosted Glass Front	Case, Secondary & Glass BP Front
5309	5152	5256	5454
5624	5469	5569	5765
5936	5782	5883	6081
6290	6111	6230	6451
6641	6440	6576	6823
6996	6769	6928	7216

##### VENEER

Case, Secondary & Front	Case, Secondary & Clear Glass Front	Case, Secondary & Frosted Glass Front	Case, Secondary & Glass BP Front
5574	5392	5496	5694
5904	5725	5825	6021
6232	6055	6155	6351
6602	6398	6518	6739
6973	6741	6878	7125
7347	7088	7244	7533

##### WITH FROST GLASS BACK (FT)

##### SINGLE (S)

##### SOURCE LAMINATE

Case, Secondary & Front	Case, Secondary & Flintwood Front	Case, Secondary & Clear Glass Front	Case, Secondary & Frosted Glass Front	Case, Secondary & Glass BP Front
2061	2160	2061	2166	2363
2172	2277	2163	2272	2480
2456	2569	2437	2555	2774
2629	2747	2599	2720	2955
2824	2947	2785	2912	3158
3027	3156	2973	3109	3368
3247	3389	3162	3304	3576
3426	3569	3341	3482	3754

##### FLINTWOOD

Case, Secondary & Front	Case, Secondary & Clear Glass Front	Case, Secondary & Frosted Glass Front	Case, Secondary & Glass BP Front
4557	4458	4564	4759
4827	4714	4823	5031
5251	5121	5238	5459
5673	5526	5648	5883
6099	5934	6063	6307
6524	6341	6475	6735
6973	6749	6890	7161
7373	7146	7289	7560

##### VENEER

Case, Secondary & Front	Case, Secondary & Clear Glass Front	Case, Secondary & Frosted Glass Front	Case, Secondary & Glass BP Front
4773	4651	4756	4952
5056	4917	5027	5236
5497	5340	5459	5680
5939	5763	5886	6122
6382	6190	6320	6563
6825	6612	6747	7008
7297	7036	7178	7450
7710	7452	7595	7866

Pricing is continued on the following page.



**H T S H G K**

**Glass Back Hutch Stacker with Sliding Door Overhead (Continued)**

**DIMENSIONS  
INCHES / MM**

H	W
45 / 1143	42 / 1066
45 / 1143	48 / 1219
45 / 1143	54 / 1372
45 / 1143	60 / 1524
45 / 1143	66 / 1676
45 / 1143	72 / 1829

**PRICING**

**WITH CLEAR GLASS HUTCH (CL) (Continued)**

**SHARED (D)**

**SOURCE LAMINATE**

Case, Secondary & Front	Case, Secondary & Flintwood Front	Case, Secondary & Clear Glass Front	Case, Secondary & Frosted Glass Front	Case, Secondary & Glass BP Front
2340	2455	2298	2401	2601
2493	2608	2455	2555	2752
2666	2780	2628	2729	2926
2877	3003	2825	2943	3166
3089	3222	3020	3159	3405
3299	3441	3214	3369	3659

**FLINTWOOD**

Case, Secondary & Front	Case, Secondary & Clear Glass Front	Case, Secondary & Frosted Glass Front	Case, Secondary & Glass BP Front
5756	5598	5702	5899
6099	5944	6044	6240
6440	6287	6388	6585
6822	6644	6764	6984
7203	7001	7140	7385
7588	7361	7520	7809

**VENEER**

Case, Secondary & Front	Case, Secondary & Clear Glass Front	Case, Secondary & Frosted Glass Front	Case, Secondary & Glass BP Front
6027	5844	5949	6147
6383	6206	6304	6502
6741	6561	6662	6862
7139	6935	7052	7275
7536	7305	7443	7690
7940	7681	7836	8126

**WITH FROST GLASS BACK (FT) (Continued)**

**APERTURE (Y)**

**SOURCE LAMINATE**

Case, Secondary & Front	Case, Secondary & Flintwood Front	Case, Secondary & Clear Glass Front	Case, Secondary & Frosted Glass Front	Case, Secondary & Glass BP Front
2607	2720	2562	2667	2863
2866	2983	2830	2926	3125
3093	3209	3058	3156	3355
3359	3483	3306	3422	3646
3623	3756	3556	3693	3940
4502	4643	4416	4573	4861

**FLINTWOOD**

Case, Secondary & Front	Case, Secondary & Clear Glass Front	Case, Secondary & Frosted Glass Front	Case, Secondary & Glass BP Front
5784	5627	5731	5929
6278	6124	6224	6420
6712	6558	6659	6857
7188	7010	7128	7350
7662	7460	7596	7843
8670	8444	8603	8891

**VENEER**

Case, Secondary & Front	Case, Secondary & Clear Glass Front	Case, Secondary & Frosted Glass Front	Case, Secondary & Glass BP Front
6049	5867	5971	6169
6558	6379	6479	6676
7008	6831	6931	7128
7501	7297	7415	7637
7993	7761	7900	8146
9023	8763	8919	9208

# hutch stackers & accessories

## HTSHP

### Perforated Hutch Stacker

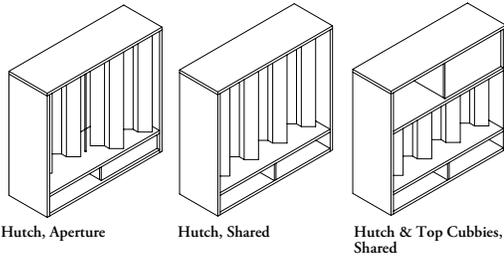

Hutch, Aperture

Hutch, Shared

Hutch & Top Cubbies, Shared

#### WHAT'S INCLUDED

Case, perforated metal with hardware, support rod (if necessary), double face tape.

#### WHAT'S EXCLUDED

Fascia add-ons, see *Storage Accessories* section.

#### NOTES

Configuration Hutch and Top Cubbies (J), is only available in heights 30" and 45".

Style Aperture (Y) is only available in widths 42" - 72" and heights 30" and 45".

#### PRODUCT OPTIONS

Configuration	Style	Height	Width	Handedness	Case & Secondary Finish	Secondary Finish Application	Perforated Divider Finish
<b>H</b> Hutch	<b>D</b> Shared	21, 30, 45	30, 36, 42, 48, 54, 60, 66, 72	<b>L</b> Left	Source Laminate	<b>A</b> Shelves	Foundation
<b>J</b> Hutch & Top Cubbies	<b>Y</b> Aperture			<b>R</b> Right	Flintwood Veneer	<b>B</b> Back <b>C</b> Shelves & Back	Mica Accent

#### SAMPLE ORDER CODE

<b>HTSHP H</b>	<b>D</b>	<b>45</b>	<b>30</b>	<b>R</b>	<b>ZA</b>	<b>ZA</b>	<b>A</b>	<b>74</b>
----------------	----------	-----------	-----------	----------	-----------	-----------	----------	-----------

#### DIMENSIONS INCHES / MM

H	W
21 / 533	30 / 762
21 / 533	36 / 914
21 / 533	42 / 1066
21 / 533	48 / 1219
21 / 533	54 / 1372
21 / 533	60 / 1524
21 / 533	66 / 1676
21 / 533	72 / 1829
30 / 762	30 / 762
30 / 762	36 / 914
30 / 762	42 / 1066
30 / 762	48 / 1219
30 / 762	54 / 1372
30 / 762	60 / 1524
30 / 762	66 / 1676
30 / 762	72 / 1829
45 / 1143	30 / 762
45 / 1143	36 / 914
45 / 1143	42 / 1066
45 / 1143	48 / 1219
45 / 1143	54 / 1372
45 / 1143	60 / 1524
45 / 1143	66 / 1676
45 / 1143	72 / 1829

#### PRICING

##### HUTCH (H) SHARED (D)

Source Laminate	Flintwood	Veneer
1651	3541	3679
1731	3708	3856
1783	3902	4060
1843	4103	4268
2168	4552	4730
2250	4751	4938
2327	4947	5144
2404	5145	5350
1911	3880	4024
2006	4053	4209
2056	4251	4416
2116	4446	4624
2513	4968	5152
2594	5166	5360
2676	5362	5568
2754	5560	5776
2442	4661	4822
2566	4853	5025
2614	5068	5250
2671	5289	5479
3232	5989	6190
3311	6208	6419
3395	6423	6645
3474	6641	6877

If Mica/Accent Divider is specified, add 52

Pricing is continued on the following page.

## H T S H P Perforated Hutch Stacker (Continued)

**DIMENSIONS  
INCHES / MM**

H	W
30 / 762	42 / 1066
30 / 762	48 / 1219
30 / 762	54 / 1372
30 / 762	60 / 1524
30 / 762	66 / 1676
30 / 762	72 / 1829
45 / 1143	42 / 1066
45 / 1143	48 / 1219
45 / 1143	54 / 1372
45 / 1143	60 / 1524
45 / 1143	66 / 1676
45 / 1143	72 / 1829

H	W
30 / 762	30 / 762
30 / 762	36 / 914
30 / 762	42 / 1066
30 / 762	48 / 1219
30 / 762	54 / 1372
30 / 762	60 / 1524
30 / 762	66 / 1676
30 / 762	72 / 1829
45 / 1143	30 / 762
45 / 1143	36 / 914
45 / 1143	42 / 1066
45 / 1143	48 / 1219
45 / 1143	54 / 1372
45 / 1143	60 / 1524
45 / 1143	66 / 1676
45 / 1143	72 / 1829

H	W
30 / 762	42 / 1066
30 / 762	48 / 1219
30 / 762	54 / 1372
30 / 762	60 / 1524
30 / 762	66 / 1676
30 / 762	72 / 1829
45 / 1143	42 / 1066
45 / 1143	48 / 1219
45 / 1143	54 / 1372
45 / 1143	60 / 1524
45 / 1143	66 / 1676
45 / 1143	72 / 1829

**PRICING**

<b>HUTCH (H) (Continued)</b>		
<b>APERTURE (Y)</b>		
Source Laminate	Flintwood	Veneer
2120	4172	4336
2183	4385	4556
2586	4921	5101
2672	5135	5328
2760	5348	5551
2841	5560	5776
2754	4981	5159
2735	5218	5406
3221	5937	6136
3227	6172	6383
3236	6405	6630
3241	6641	6877

<b>HUTCH &amp; TOP CUBBIES (J)</b>		
<b>SHARED (D)</b>		
Source Laminate	Flintwood	Veneer
1867	4790	4989
1960	5031	5244
2021	5310	5541
2100	5592	5833
2446	6125	6382
2543	6405	6677
2643	6688	6970
2739	6968	7267
2277	5319	5539
2390	5582	5812
2468	5876	6119
2559	6170	6427
2992	6783	7058
3110	7078	7368
3231	7372	7677
3345	7668	7986

<b>APERTURE (Y)</b>		
Source Laminate	Flintwood	Veneer
2089	5195	5417
2172	5499	5735
2523	6058	6308
2628	6361	6630
2733	6665	6946
2834	6968	7267
2629	5778	6018
2690	6092	6347
3098	6725	6996
3189	7037	7325
3284	7351	7653
3368	7668	7986

If Mica/Accent Divider is specified, add 52

# hutch stackers & accessories

## HTSHPK

### Perforated Back Hutch Stacker with Sliding Door Overhead

#### WHAT'S INCLUDED

Case, perforated metal with hardware, sliding door with hardware, lock and keys (if specified), support rod (if necessary), double face tape.

#### WHAT'S EXCLUDED

Fascia add-ons, see *Storage Accessories* section.

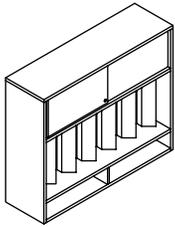

Shared

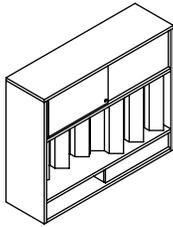

Aperture

#### PRODUCT OPTIONS

Style	Height	Width	Handedness	Case & Secondary Finish	Door Finish	Perforated Divider Finish	Handle Finish	Key
D Shared	45	42, 48, 54, 60, 66, 72	L Left	Source Laminate	Source Laminate	Foundation	Foundation	N No Key
Y Aperture			R Right	Flintwood Veneer	Flintwood Veneer Glass Frosted Glass Back-Painted Glass	Mica Accent	Mica	K Key Alike R Key Random

#### SAMPLE ORDER CODE

<b>HTSHPKD</b>	<b>45</b>	<b>48</b>	<b>R</b>	<b>ZA</b>	<b>ZA</b>	<b>ZA</b>	<b>74</b>	<b>60</b>	<b>N</b>
----------------	-----------	-----------	----------	-----------	-----------	-----------	-----------	-----------	----------

#### DIMENSIONS INCHES / MM

H	W
45 / 1143	42 / 1066
45 / 1143	48 / 1219
45 / 1143	54 / 1372
45 / 1143	60 / 1524
45 / 1143	66 / 1676
45 / 1143	72 / 1829

#### PRICING

##### SHARED (D)

##### SOURCE LAMINATE

Case, Secondary & Front	Case, Secondary & Flintwood Front	Case, Secondary & Clear Glass Front	Case, Secondary & Frosted Glass Front	Case, Secondary & Glass BP Front
2689	2794	2990	2732	2847
2773	2875	3072	2810	2928
2868	2967	3165	2905	3019
3300	3419	3641	3354	3478
3418	3554	3803	3486	3621
3538	3692	3982	3622	3765

##### FLINTWOOD

Case, Secondary & Front	Case, Secondary & Clear Glass Front	Case, Secondary & Frosted Glass Front	Case, Secondary & Glass BP Front	Case, Secondary & Front	Case, Secondary & Clear Glass Front	Case, Secondary & Frosted Glass Front	Case, Secondary & Glass BP Front
6373	6215	6319	6517	6691	6509	6611	6811
6667	6515	6611	6811	7000	6822	6923	7117
7282	7131	7230	7428	7647	7469	7569	7767
7616	7440	7558	7779	7997	7794	7911	8134
7949	7747	7886	8133	8346	8116	8254	8502
8284	8058	8215	8505	8699	8443	8598	8888

##### VENEER

If Mica/Accent Divider is specified, add 52

Pricing is continued on the following page.

**H T S H P K**

**Perforated Back Hutch Stacker with Sliding Door Overhead (Continued)**

**DIMENSIONS  
INCHES / MM**

H	W
45 / 1143	42 / 1066
45 / 1143	48 / 1219
45 / 1143	54 / 1372
45 / 1143	60 / 1524
45 / 1143	66 / 1676
45 / 1143	72 / 1829

**PRICING**

**APERTURE (Y)**

**SOURCE LAMINATE**

Case, Secondary & Front	Case, Secondary & Flintwood Front	Case, Secondary & Clear Glass Front	Case, Secondary & Frosted Glass Front	Case, Secondary & Glass BP Front
2928	3033	3229	2971	3086
2999	3097	3295	3036	3151
3407	3508	3705	3443	3561
3498	3618	3837	3549	3675
3592	3727	3976	3659	3791
3675	3833	4121	3759	3901

**FLINTWOOD**

H	W
45 / 1143	42 / 1066
45 / 1143	48 / 1219
45 / 1143	54 / 1372
45 / 1143	60 / 1524
45 / 1143	66 / 1676
45 / 1143	72 / 1829

Case, Secondary & Front	Case, Secondary & Clear Glass Front	Case, Secondary & Frosted Glass Front	Case, Secondary & Glass BP Front	Case, Secondary & Front	Case, Secondary & Clear Glass Front	Case, Secondary & Frosted Glass Front	Case, Secondary & Glass BP Front
6276	6118	6223	6420	6590	6408	6511	6709
6590	6436	6535	6733	6918	6739	6840	7036
7225	7070	7171	7369	7586	7406	7508	7705
7577	7400	7519	7741	7955	7754	7869	8093
7930	7728	7864	8113	8326	8095	8232	8479
8284	8058	8215	8505	8699	8443	8598	8888

**veneer**

If Mica/Accent Divider is specified, add 52

# hutch stackers & accessories

## HTSHE

### Elevated Hutch Stacker

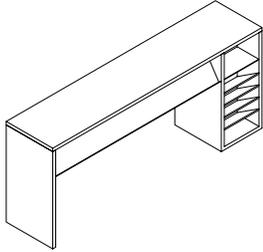

The Elevated Hutch Stacker mounts perpendicular to the worksurface to provide storage, privacy and workstation delineation in a benching environment.

#### WHAT'S INCLUDED

1 Lateral Tower unit with hardware, lock and keys (if specified).

#### WHAT'S EXCLUDED

Hutch to Worksurface Support (HTWF) brackets.

#### NOTES

Ships disassembled.

#### PRODUCT OPTIONS

Height	Depth	Width	Style	Case & Secondary Finish	Metal Paint Finish	Key
51	16	60, 66, 72, 78, 84, 90, 96	<b>P</b> Paper Filing <b>H</b> Hinged Door	Source Laminate Flintwood Veneer	Foundation Mica Accent	<b>N</b> No Key <b>K</b> Key Alike <b>R</b> Key Random

#### SAMPLE ORDER CODE

<b>HTSHE 51</b>	<b>16</b>	<b>72</b>	<b>H</b>	<b>ZA</b>	<b>ZA</b>	<b>74</b>	<b>N</b>
-----------------	-----------	-----------	----------	-----------	-----------	-----------	----------

#### DIMENSIONS INCHES / MM

H	D	W
51 / 1295	16 / 406	60 / 1524
51 / 1295	16 / 406	66 / 1676
51 / 1295	16 / 406	72 / 1829
51 / 1295	16 / 406	78 / 1981
51 / 1295	16 / 406	84 / 2134
51 / 1295	16 / 406	90 / 2286
51 / 1295	16 / 406	96 / 2438

51 / 1295	16 / 406	60 / 1524
51 / 1295	16 / 406	66 / 1676
51 / 1295	16 / 406	72 / 1829
51 / 1295	16 / 406	78 / 1981
51 / 1295	16 / 406	84 / 2134
51 / 1295	16 / 406	90 / 2286
51 / 1295	16 / 406	96 / 2438

#### PRICING

##### PAPER FILING (P)

Source Laminate	Flintwood	Veneer
1907	2628	2760
1989	2674	2807
2072	2720	2855
2111	2767	2903
2154	2810	2953
2199	2869	3011
2242	2925	3072

##### HINGED DOOR (H)

Source Laminate	Flintwood	Veneer
1838	3101	3256
1919	3148	3306
1999	3192	3354
2480	3236	3398
2480	3278	3442
2529	3342	3511
2581	3412	3579

If Mica/Accent Louvered Divider is specified, add 52



# hutch stackers & accessories

## HTAH

### Hutch Fascia Add-On

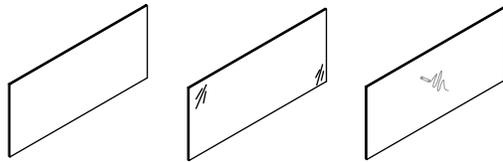

Fabric

Back-Painted Glass

Whiteboard

#### WHAT'S INCLUDED

1 fascia, velcro.

#### NOTES

Hutch Style Single with Cubby (SG), Aperture with Cubby (YC) and Shared with Cubby (SC) are only available in heights 30" and 45".

Styles Aperture (YP) and Aperture with Cubby (YC) are only available in widths 42" - 72".

Application Exterior (E) is only available if Style Single (SD), Single with Cubby (SG), Aperture (YP) or Aperture with Cubby (YC) is selected.

#### PRODUCT OPTIONS

Configuration	Style of Hutch	Application	Height of Hutch	Width of Hutch	Finish
<b>F</b> Fabric	<b>SD</b> Single	<b>E</b> Exterior	21, 30, 45	30, 36, 42, 48, 54, 60, 66, 72	Fabric
<b>G</b> Back-Painted Glass	<b>SG</b> Single with Cubby	<b>N</b> Interior			<b>K1</b> Storm White
<b>W</b> Whiteboard	<b>SH</b> Shared				<b>K7</b> Very White
	<b>SC</b> Shared with Cubby				<b>J6</b> Gris
	<b>YP</b> Aperture				<b>WB</b> Whiteboard
	<b>YC</b> Aperture with Cubby				

#### SAMPLE ORDER CODE

<b>HTAH F</b>	<b>SG</b>	<b>E</b>	<b>30</b>	<b>36</b>	<b>K671</b>
---------------	-----------	----------	-----------	-----------	-------------

#### DIMENSIONS INCHES / MM

H	W
21 / 533	30 / 762
21 / 533	36 / 914
21 / 533	42 / 1066
21 / 533	48 / 1219
21 / 533	54 / 1372
21 / 533	60 / 1524
21 / 533	66 / 1676
21 / 533	72 / 1829
30 / 762	30 / 762
30 / 762	36 / 914
30 / 762	42 / 1066
30 / 762	48 / 1219
30 / 762	54 / 1372
30 / 762	60 / 1524
30 / 762	66 / 1676
30 / 762	72 / 1829

#### PRICING

##### FABRIC (F)

##### SINGLE (SD)

##### EXTERIOR (E)

COM/ Gr. A	Gr. 1	Gr. 2	Gr. 3	Gr. 4	Gr. 5	Gr. 6	Gr. 7
73	74	80	82	84	85	88	89
87	89	92	94	97	99	101	104
100	103	110	112	115	119	122	126
117	121	124	127	130	133	140	143
129	133	136	142	148	152	156	159
145	151	154	158	161	165	175	179
159	163	171	176	181	184	189	197
176	181	184	189	195	205	210	214
78	81	82	84	87	88	90	94
90	94	97	99	101	104	111	113
104	111	113	117	121	123	127	129
123	126	129	133	136	142	148	152
136	142	148	152	157	159	163	167
153	157	160	164	171	178	182	186
165	174	179	182	187	193	203	208
182	187	191	202	208	211	217	223

##### INTERIOR (N)

COM Gr. A	Gr. 1	Gr. 2	Gr. 3	Gr. 4	Gr. 5	Gr. 6	Gr. 7
73	74	80	82	84	85	88	89
87	89	92	94	97	99	101	104
100	103	110	112	115	119	122	126
117	121	124	127	130	133	140	143
129	133	136	142	148	152	156	159
145	151	154	158	161	165	175	179
159	163	171	176	181	184	189	197
176	181	184	189	195	205	210	214
78	81	82	84	87	88	90	94
90	94	97	99	101	104	111	113
104	111	113	117	121	123	127	129
123	126	129	133	136	142	148	152
136	142	148	152	157	159	163	167
153	157	160	164	171	178	182	186
165	174	179	182	187	193	203	208
182	187	191	202	208	211	217	223



**H T A H**  
**Hutch Fascia Add-On (Continued)**

**DIMENSIONS  
INCHES / MM**

H	W
45 / 1143	30 / 762
45 / 1143	36 / 914
45 / 1143	42 / 1066
45 / 1143	48 / 1219
45 / 1143	54 / 1372
45 / 1143	60 / 1524
45 / 1143	66 / 1676
45 / 1143	72 / 1829
30 / 762	30 / 762
30 / 762	36 / 914
30 / 762	42 / 1066
30 / 762	48 / 1219
30 / 762	54 / 1372
30 / 762	60 / 1524
30 / 762	66 / 1676
30 / 762	72 / 1829
45 / 1143	30 / 762
45 / 1143	36 / 914
45 / 1143	42 / 1066
45 / 1143	48 / 1219
45 / 1143	54 / 1372
45 / 1143	60 / 1524
45 / 1143	66 / 1676
45 / 1143	72 / 1829

**PRICING**

<b>FABRIC (F) (Continued)</b>															
<b>SINGLE (SD) (Continued)</b>															
<b>EXTERIOR (E) (Continued)</b>					<b>INTERIOR (N) (Continued)</b>										
COM/ Gr. A	Gr. 1	Gr. 2	Gr. 3	Gr. 4	Gr. 5	Gr. 6	Gr. 7	COM Gr. A	Gr. 1	Gr. 2	Gr. 3	Gr. 4	Gr. 5	Gr. 6	Gr. 7
82	84	85	88	91	94	96	98	82	84	85	88	91	94	96	98
96	98	100	103	106	112	114	119	96	98	100	103	106	112	114	119
113	115	121	123	127	129	133	136	113	115	121	123	127	129	133	136
128	131	134	141	145	151	154	158	128	131	134	141	145	151	154	158
143	149	153	157	160	164	174	178	143	149	153	157	160	164	174	178
159	163	171	176	181	184	189	197	159	163	171	176	181	184	189	197
178	182	186	191	197	206	211	216	178	182	186	191	197	206	211	216
191	202	206	211	217	223	231	239	191	202	206	211	217	223	231	239
<b>SINGLE WITH CUBBY (SG)</b>															
<b>EXTERIOR (E)</b>					<b>INTERIOR (N)</b>										
COM/ Gr. A	Gr. 1	Gr. 2	Gr. 3	Gr. 4	Gr. 5	Gr. 6	Gr. 7	COM/ Gr. A	Gr. 1	Gr. 2	Gr. 3	Gr. 4	Gr. 5	Gr. 6	Gr. 7
84	87	88	90	94	97	99	101	92	96	98	100	104	110	112	114
99	101	104	111	114	117	121	123	112	114	119	122	126	128	130	134
119	122	126	128	131	136	141	145	129	133	136	142	148	152	156	159
133	140	142	148	152	156	159	164	149	153	157	160	165	174	178	182
152	156	159	163	167	176	181	184	165	174	179	182	187	193	203	208
165	174	179	182	187	193	203	208	184	189	197	204	209	214	219	228
184	189	197	204	209	214	219	228	205	210	214	220	228	238	242	249
204	209	213	219	227	235	241	247	220	228	238	243	250	258	266	272
88	90	94	96	98	100	103	111	97	99	101	104	110	113	117	121
104	111	113	117	121	123	127	129	117	121	124	127	130	133	140	143
124	127	130	134	140	143	149	153	134	141	145	149	152	157	161	165
141	145	151	154	158	161	165	175	156	159	163	171	178	181	184	189
158	161	165	175	181	183	188	193	176	181	184	189	195	205	210	214
178	182	186	191	197	206	211	216	193	203	208	212	218	224	233	240
193	203	208	212	218	224	233	240	213	218	225	234	241	247	255	264
212	217	224	233	240	246	254	263	234	241	247	254	263	270	278	286

Pricing is continued on the following page.

# hutch stackers & accessories

## H T A H

### Hutch Fascia Add-On (Continued)

#### DIMENSIONS INCHES / MM

H	W
21 / 533	30 / 762
21 / 533	36 / 914
21 / 533	42 / 1066
21 / 533	48 / 1219
21 / 533	54 / 1372
21 / 533	60 / 1524
21 / 533	66 / 1676
21 / 533	72 / 1829
30 / 762	30 / 762
30 / 762	36 / 914
30 / 762	42 / 1066
30 / 762	48 / 1219
30 / 762	54 / 1372
30 / 762	60 / 1524
30 / 762	66 / 1676
30 / 762	72 / 1829
45 / 1143	30 / 762
45 / 1143	36 / 914
45 / 1143	42 / 1066
45 / 1143	48 / 1219
45 / 1143	54 / 1372
45 / 1143	60 / 1524
45 / 1143	66 / 1676
45 / 1143	72 / 1829
30 / 762	30 / 762
30 / 762	36 / 914
30 / 762	42 / 1066
30 / 762	48 / 1219
30 / 762	54 / 1372
30 / 762	60 / 1524
30 / 762	66 / 1676
30 / 762	72 / 1829
45 / 1143	30 / 762
45 / 1143	36 / 914
45 / 1143	42 / 1066
45 / 1143	48 / 1219
45 / 1143	54 / 1372
45 / 1143	60 / 1524
45 / 1143	66 / 1676
45 / 1143	72 / 1829

#### PRICING

##### FABRIC (F) (Continued)

##### SHARED (SH)

##### INTERIOR (N)

COM/ Gr. A	Gr. 1	Gr. 2	Gr. 3	Gr. 4	Gr. 5	Gr. 6	Gr. 7
88	90	94	96	98	100	103	111
104	111	113	117	121	123	127	129
124	127	130	134	140	143	149	153
141	145	151	154	158	161	165	175
158	161	165	175	181	183	188	193
178	182	186	191	197	206	211	216
193	203	208	212	218	224	233	240
212	217	224	233	240	246	254	263
92	96	98	100	104	110	112	114
112	114	119	122	126	128	130	134
129	133	136	142	148	152	156	159
149	153	157	160	165	174	178	182
165	174	179	182	187	193	203	208
184	189	197	204	209	214	219	228
205	210	214	220	228	238	242	249
220	228	238	243	250	258	266	272
304	312	323	334	344	351	365	374
367	375	390	399	409	424	436	451
427	438	453	467	482	496	510	525
487	502	517	529	548	564	581	600
549	564	581	600	617	635	654	673
609	628	646	666	686	707	728	751
671	690	710	732	756	777	800	823
731	755	776	798	822	849	872	899

##### SHARED WITH CUBBY (SC)

##### INTERIOR (N)

COM/ Gr. A	Gr. 1	Gr. 2	Gr. 3	Gr. 4	Gr. 5	Gr. 6	Gr. 7
78	81	82	84	87	88	90	94
90	94	97	99	101	104	111	113
104	111	113	117	121	123	127	129
123	126	129	133	136	142	148	152
136	142	148	152	157	159	163	167
153	157	160	164	171	178	182	186
165	174	179	182	187	193	203	208
182	187	191	202	208	211	217	223
82	84	85	88	91	94	96	98
96	98	100	103	106	112	114	119
113	115	121	123	127	129	133	136
128	131	134	141	145	151	154	158
143	149	153	157	160	164	174	178
159	163	171	176	181	184	189	197
178	182	186	191	197	206	211	216
191	202	206	211	217	223	231	239

Pricing is continued on the following page.

**H T A H**

**Hutch Fascia Add-On (Continued)**

**DIMENSIONS  
INCHES / MM**

**PRICING**

**FABRIC (F) (Continued)**

**APERTURE (YP)**

**EXTERIOR (E) INTERIOR (N)**

DIMENSIONS		EXTERIOR (E)								INTERIOR (N)							
H	W	COM/ Gr. A	Gr. 1	Gr. 2	Gr. 3	Gr. 4	Gr. 5	Gr. 6	Gr. 7	COM/ Gr. A	Gr. 1	Gr. 2	Gr. 3	Gr. 4	Gr. 5	Gr. 6	Gr. 7
21 / 533	42 / 1066	54	55	57	58	60	61	63	66	54	55	57	58	60	61	63	66
21 / 533	48 / 1219	60	61	63	68	70	71	73	74	60	61	63	68	70	71	73	74
21 / 533	54 / 1372	69	70	73	74	78	81	83	85	69	70	73	74	78	81	83	85
21 / 533	60 / 1524	78	81	82	84	87	88	90	94	78	81	82	84	87	88	90	94
21 / 533	66 / 1676	84	87	88	90	94	97	99	101	84	87	88	90	94	97	99	101
21 / 533	72 / 1829	90	94	97	99	101	104	111	113	90	94	97	99	101	104	111	113
30 / 762	42 / 1066	85	88	89	92	97	98	100	103	85	88	89	92	97	98	100	103
30 / 762	48 / 1219	97	99	101	104	110	113	117	121	97	99	101	104	110	113	117	121
30 / 762	54 / 1372	111	113	115	121	124	127	129	133	111	113	115	121	124	127	129	133
30 / 762	60 / 1524	123	126	129	133	136	142	148	152	123	126	129	133	136	142	148	152
30 / 762	66 / 1676	133	140	142	148	152	156	159	164	133	140	142	148	152	156	159	164
30 / 762	72 / 1829	148	152	156	159	164	171	176	181	148	152	156	159	164	171	176	181
45 / 1143	42 / 1066	140	143	149	153	158	160	164	171	140	143	149	153	158	160	164	171
45 / 1143	48 / 1219	158	161	165	175	181	183	188	193	158	161	165	175	181	183	188	193
45 / 1143	54 / 1372	179	183	187	193	202	208	212	217	179	183	187	193	202	208	212	217
45 / 1143	60 / 1524	202	206	211	216	221	231	239	244	202	206	211	216	221	231	239	244
45 / 1143	66 / 1676	217	223	233	240	247	251	259	269	217	223	233	240	247	251	259	269
45 / 1143	72 / 1829	239	244	251	259	269	273	284	294	239	244	251	259	269	273	284	294

**APERTURE WITH CUBBY (YC)**

**EXTERIOR (E) INTERIOR (N)**

DIMENSIONS		EXTERIOR (E)								INTERIOR (N)							
H	W	COM/ Gr. A	Gr. 1	Gr. 2	Gr. 3	Gr. 4	Gr. 5	Gr. 6	Gr. 7	COM/ Gr. A	Gr. 1	Gr. 2	Gr. 3	Gr. 4	Gr. 5	Gr. 6	Gr. 7
30 / 762	42 / 1066	54	55	57	58	60	61	63	66	54	55	57	58	60	61	63	66
30 / 762	48 / 1219	60	61	63	68	70	71	73	74	60	61	63	68	70	71	73	74
30 / 762	54 / 1372	69	70	73	74	78	81	83	85	69	70	73	74	78	81	83	85
30 / 762	60 / 1524	78	81	82	84	87	88	90	94	78	81	82	84	87	88	90	94
30 / 762	66 / 1676	84	87	88	90	94	97	99	101	84	87	88	90	94	97	99	101
30 / 762	72 / 1829	90	94	97	99	101	104	111	113	90	94	97	99	101	104	111	113
45 / 1143	42 / 1066	85	88	89	92	97	98	100	103	85	88	89	92	97	98	100	103
45 / 1143	48 / 1219	97	99	101	104	110	113	117	121	97	99	101	104	110	113	117	121
45 / 1143	54 / 1372	111	113	115	121	124	127	129	133	111	113	115	121	124	127	129	133
45 / 1143	60 / 1524	123	126	129	133	136	142	148	152	123	126	129	133	136	142	148	152
45 / 1143	66 / 1676	133	140	142	148	152	156	159	164	133	140	142	148	152	156	159	164
45 / 1143	72 / 1829	148	152	156	159	164	171	176	181	148	152	156	159	164	171	176	181

Pricing is continued on the following page.

# hutch stackers & accessories

## H T A H

### Hutch Fascia Add-On (Continued)

#### DIMENSIONS INCHES / MM

#### PRICING

#### BACK-PAINTED GLASS (G)

H	W	SINGLE (SD)		SINGLE WITH CUBBY (SG)		SHARED (SH)	SHARED WITH CUBBY (SC)
		Exterior (E)	Interior (N)	Exterior (E)	Interior (N)	Interior (N)	Interior (N)
21 / 533	30 / 762	270	270	n/a	n/a	286	n/a
21 / 533	36 / 914	328	328	n/a	n/a	346	n/a
21 / 533	42 / 1066	387	387	n/a	n/a	409	n/a
21 / 533	48 / 1219	443	443	n/a	n/a	469	n/a
21 / 533	54 / 1372	502	502	n/a	n/a	529	n/a
21 / 533	60 / 1524	557	557	n/a	n/a	593	n/a
21 / 533	66 / 1676	615	615	n/a	n/a	654	n/a
21 / 533	72 / 1829	675	675	n/a	n/a	715	n/a
30 / 762	30 / 762	472	472	472	286	499	286
30 / 762	36 / 914	574	574	574	346	608	328
30 / 762	42 / 1066	675	675	675	409	715	387
30 / 762	48 / 1219	776	776	776	469	822	443
30 / 762	54 / 1372	879	879	879	529	929	502
30 / 762	60 / 1524	979	979	979	593	1038	557
30 / 762	66 / 1676	1078	1078	1078	654	1145	615
30 / 762	72 / 1829	1181	1181	1181	715	1252	675
45 / 1143	30 / 762	808	808	808	499	858	472
45 / 1143	36 / 914	984	984	984	608	1042	574
45 / 1143	42 / 1066	1157	1157	1157	715	1227	675
45 / 1143	48 / 1219	1329	1329	1329	822	1410	776
45 / 1143	54 / 1372	1504	1504	1504	929	1596	879
45 / 1143	60 / 1524	1677	1677	1677	1038	1780	979
45 / 1143	66 / 1676	1853	1853	1853	1145	1965	1078
45 / 1143	72 / 1829	2025	2025	2025	1252	2148	1181

#### APERTURE (YP)

Exterior (E)	Interior (N)
21 / 533	42 / 1066
21 / 533	48 / 1219
21 / 533	54 / 1372
21 / 533	60 / 1524
21 / 533	66 / 1676
21 / 533	72 / 1829
30 / 762	42 / 1066
30 / 762	48 / 1219
30 / 762	54 / 1372
30 / 762	60 / 1524
30 / 762	66 / 1676
30 / 762	72 / 1829
45 / 1143	42 / 1066
45 / 1143	48 / 1219
45 / 1143	54 / 1372
45 / 1143	60 / 1524
45 / 1143	66 / 1676
45 / 1143	72 / 1829

#### APERTURE WITH CUBBY (YC)

Exterior (E)	Interior (N)	Exterior (E)	Interior (N)
n/a	n/a	n/a	n/a
n/a	n/a	n/a	n/a
n/a	n/a	n/a	n/a
n/a	n/a	n/a	n/a
n/a	n/a	n/a	n/a
n/a	n/a	n/a	n/a
286	286	175	175
338	338	206	206
390	390	235	235
437	437	266	266
489	489	298	298
542	542	328	328
491	491	304	304
580	580	359	359
666	666	412	412
753	753	465	465
838	838	520	520
925	925	574	574

Pricing is continued on the following page.

**H T A H**  
**Hutch Fascia Add-On (Continued)**

**DIMENSIONS  
 INCHES / MM**

**PRICING**

**WHITEBOARD (W)**

H	W
21 / 533	30 / 762
21 / 533	36 / 914
21 / 533	42 / 1066
21 / 533	48 / 1219
21 / 533	54 / 1372
21 / 533	60 / 1524
21 / 533	66 / 1676
21 / 533	72 / 1829
30 / 762	30 / 762
30 / 762	36 / 914
30 / 762	42 / 1066
30 / 762	48 / 1219
30 / 762	54 / 1372
30 / 762	60 / 1524
30 / 762	66 / 1676
30 / 762	72 / 1829
45 / 1143	30 / 762
45 / 1143	36 / 914
45 / 1143	42 / 1066
45 / 1143	48 / 1219
45 / 1143	54 / 1372
45 / 1143	60 / 1524
45 / 1143	66 / 1676
45 / 1143	72 / 1829

SINGLE (SD)		SINGLE WITH CUBBY (SG)		SHARED (SH)	SHARED WITH CUBBY (SC)
Exterior (E)	Interior (N)	Exterior (E)	Interior (N)	Interior (N)	Interior (N)
53	53	n/a	n/a	53	n/a
63	63	n/a	n/a	63	n/a
78	78	n/a	n/a	78	n/a
88	88	n/a	n/a	88	n/a
103	103	n/a	n/a	103	n/a
122	122	n/a	n/a	122	n/a
140	140	n/a	n/a	140	n/a
156	156	n/a	n/a	156	n/a
58	58	58	58	58	58
74	74	74	74	74	74
92	92	92	92	92	92
111	111	111	111	111	111
133	133	133	133	133	133
158	158	158	158	158	158
182	182	182	182	182	182
209	209	209	209	209	209
70	70	70	70	70	70
96	96	96	96	96	96
122	122	122	122	122	122
148	148	148	148	148	148
182	182	182	182	182	182
218	218	218	218	218	218
256	256	256	256	256	256
294	294	294	294	294	294

**APERTURE (YP)**

Exterior (E)	Interior (N)
21 / 533	42 / 1066
21 / 533	48 / 1219
21 / 533	54 / 1372
21 / 533	60 / 1524
21 / 533	66 / 1676
21 / 533	72 / 1829
30 / 762	42 / 1066
30 / 762	48 / 1219
30 / 762	54 / 1372
30 / 762	60 / 1524
30 / 762	66 / 1676
30 / 762	72 / 1829
45 / 1143	42 / 1066
45 / 1143	48 / 1219
45 / 1143	54 / 1372
45 / 1143	60 / 1524
45 / 1143	66 / 1676
45 / 1143	72 / 1829

**APERTURE WITH CUBBY (YC)**

Exterior (E)	Interior (N)	Exterior (E)	Interior (N)
61	61	n/a	n/a
70	70	n/a	n/a
83	83	n/a	n/a
92	92	n/a	n/a
103	103	n/a	n/a
117	117	n/a	n/a
78	78	78	78
88	88	88	88
103	103	103	103
122	122	122	122
140	140	140	140
156	156	156	156
61	61	61	61
70	70	70	70
83	83	83	83
92	92	92	92
103	103	103	103
117	117	117	117

# hutch stackers & accessories

## HTAV

### Hutch Overhead Fascia Add-On

#### WHAT'S INCLUDED

1 fascia, velcro.

#### NOTES

Style Aperture (Y) is only available in widths 42" - 72".



#### PRODUCT OPTIONS

Configuration	Style of Hutch	Height of Hutch	Width of Hutch	Finish
<b>F</b> Fabric	<b>S</b> Single	30, 45	30, 36, 42, 48, 54, 60, 66, 72	Fabric
<b>G</b> Back-Painted Glass	<b>D</b> Shared			<b>K1</b> Storm White
<b>W</b> Whiteboard	<b>Y</b> Aperture			<b>K7</b> Very White
				<b>J6</b> Gris
				<b>WB</b> Whiteboard

#### SAMPLE ORDER CODE

<b>HTAV F</b>	<b>S</b>	<b>45</b>	<b>36</b>	<b>K671</b>
---------------	----------	-----------	-----------	-------------

#### DIMENSIONS INCHES / MM

H	W
30 / 762	30 / 762
30 / 762	36 / 914
30 / 762	42 / 1066
30 / 762	48 / 1219
30 / 762	54 / 1372
30 / 762	60 / 1524
30 / 762	66 / 1676
30 / 762	72 / 1829
45 / 1143	30 / 762
45 / 1143	36 / 914
45 / 1143	42 / 1066
45 / 1143	48 / 1219
45 / 1143	54 / 1372
45 / 1143	60 / 1524
45 / 1143	66 / 1676
45 / 1143	72 / 1829

#### PRICING

##### FABRIC (F)

##### SINGLE (S)

COM/	Gr. A	Gr. 1	Gr. 2	Gr. 3	Gr. 4	Gr. 5	Gr. 6	Gr. 7
52	53	54	55	57	58	60	61	
60	61	63	68	70	71	73	74	
71	73	78	80	82	84	85	88	
82	84	85	88	91	94	96	98	
90	94	97	99	101	104	111	113	
100	103	110	112	115	119	122	126	
113	115	121	123	127	129	133	136	
123	126	129	133	136	142	148	152	
78	81	82	84	87	88	90	94	
90	94	97	99	101	104	111	113	
104	111	113	117	121	123	127	129	
123	126	129	133	136	142	148	152	
136	142	148	152	157	159	163	167	
153	157	160	164	171	178	182	186	
165	174	179	182	187	193	203	208	
182	187	191	202	208	211	217	223	

##### SHARED (D)

COM	Gr. A	Gr. 1	Gr. 2	Gr. 3	Gr. 4	Gr. 5	Gr. 6	Gr. 7
52	53	54	55	57	58	60	61	
60	61	63	68	70	71	73	74	
71	73	78	80	82	84	85	88	
82	84	85	88	91	94	96	98	
90	94	97	99	101	104	111	113	
100	103	110	112	115	119	122	126	
113	115	121	123	127	129	133	136	
123	126	129	133	136	142	148	152	
78	81	82	84	87	88	90	94	
90	94	97	99	101	104	111	113	
104	111	113	117	121	123	127	129	
123	126	129	133	136	142	148	152	
136	142	148	152	157	159	163	167	
153	157	160	164	171	178	182	186	
165	174	179	182	187	193	203	208	
182	187	191	202	208	211	217	223	

Pricing is continued on the following page.

**H T A V**  
**Hutch Overhead Fascia Add-On**  
**(Continued)**

**DIMENSIONS**  
**INCHES / MM**

H	W
30 / 762	42 / 1066
30 / 762	48 / 1219
30 / 762	54 / 1372
30 / 762	60 / 1524
30 / 762	66 / 1676
30 / 762	72 / 1829

45 / 1143	42 / 1066
45 / 1143	48 / 1219
45 / 1143	54 / 1372
45 / 1143	60 / 1524
45 / 1143	66 / 1676
45 / 1143	72 / 1829

30 / 762	30 / 762
30 / 762	36 / 914
30 / 762	42 / 1066
30 / 762	48 / 1219
30 / 762	54 / 1372
30 / 762	60 / 1524
30 / 762	66 / 1676
30 / 762	72 / 1829

45 / 1143	30 / 762
45 / 1143	36 / 914
45 / 1143	42 / 1066
45 / 1143	48 / 1219
45 / 1143	54 / 1372
45 / 1143	60 / 1524
45 / 1143	66 / 1676
45 / 1143	72 / 1829

30 / 762	30 / 762
30 / 762	36 / 914
30 / 762	42 / 1066
30 / 762	48 / 1219
30 / 762	54 / 1372
30 / 762	60 / 1524
30 / 762	66 / 1676
30 / 762	72 / 1829

45 / 1143	30 / 762
45 / 1143	36 / 914
45 / 1143	42 / 1066
45 / 1143	48 / 1219
45 / 1143	54 / 1372
45 / 1143	60 / 1524
45 / 1143	66 / 1676
45 / 1143	72 / 1829

**PRICING**

**FABRIC (F) (Continued)**

**APERTURE (Y)**

COM/ Gr. A	Gr. 1	Gr. 2	Gr. 3	Gr. 4	Gr. 5	Gr. 6	Gr. 7
35	36	36	37	39	41	43	44
39	41	43	44	45	48	50	51
48	50	51	52	53	54	55	57
52	53	54	55	57	58	60	61
55	57	58	59	61	63	66	69
60	61	63	68	70	71	73	74
54	55	57	58	60	61	63	66
60	61	63	68	70	71	73	74
69	70	73	74	78	81	83	85
78	81	82	84	87	88	90	94
84	87	88	90	94	97	99	101
90	94	97	99	101	104	111	113

**BACK-PAINTED GLASS (G)**

SINGLE (S)	SHARED (D)	APERTURE (Y)
203	203	n/a
240	240	n/a
279	279	141
317	317	159
361	361	180
398	398	203
437	437	218
480	480	240
299	299	n/a
361	361	n/a
421	421	210
480	480	240
541	541	269
600	600	299
657	657	331
717	717	361

**WHITEBOARD (W)**

SINGLE (S)	SHARED (D)	APERTURE (Y)
55	51	n/a
60	54	n/a
69	59	59
74	63	63
88	73	73
100	83	83
115	92	92
127	100	100
71	60	n/a
84	70	n/a
97	81	81
111	88	88
133	104	104
158	124	124
182	141	141
209	158	158

# hutch stackers & accessories

## HTHA

### Hutch Accessory

Hutch Accessory can be placed inside hutch stackers for better space organization and convenient document piling.

#### WHAT'S INCLUDED

1 hutch accessory.

#### NOTES

Configuration With Overhead/Cubbies (W) is only available in heights 30" and 45".

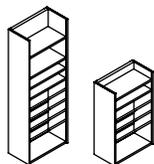

#### PRODUCT OPTIONS

Height of Hutch	Configuration of Hutch	Width	Case Wood Finish	Case Paint Finish
21, 30, 45	<b>W</b> With Overhead/Cubbies <b>N</b> Without Overhead/Cubbies	12	Source Laminate	Foundation Mica Accent

#### SAMPLE ORDER CODE

<b>HTHA 30</b>	<b>N</b>	<b>12</b>	<b>Y5</b>	<b>74</b>
----------------	----------	-----------	-----------	-----------

#### DIMENSIONS INCHES / MM

H	W
21 / 535	12 / 305
30 / 762	12 / 305
45 / 1143	12 / 305

#### PRICING

##### WITHOUT OVERHEAD/CUBBIES (N)

Foundation	Accent/Mica
337	351
499	525
499	525

##### WITH OVERHEAD/CUBBIES (W)

Foundation	Accent/Mica
n/a	n/a
337	351
746	783





storage

# storage product map

## H T S B Bookcase Stacker

Page 472

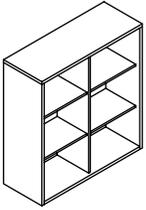

Single

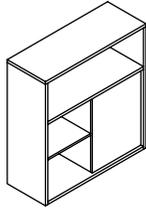

Shared, Open Through Top

## H T S B S Solid Door Bookcase Stacker

Page 474

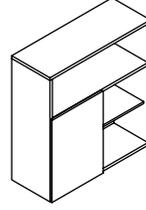

Single

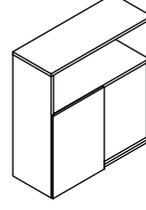

Shared, Open Through Top

## H T S B F Fabric Door Bookcase Stacker

Page 476

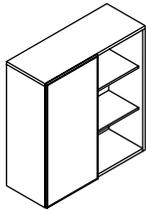

Single

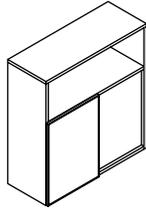

Shared, Open Through Top

## H T S B W Writable Door Bookcase Stacker

Page 480

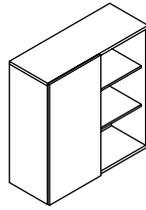

Single

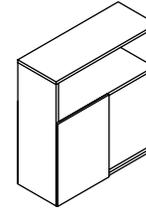

Shared, Open Through Top

## H T S B V Variable Bookcase Stacker

Page 482

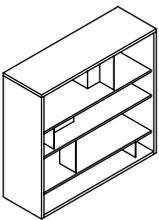

Single

## H T S S S Single Solid Hinged Door Stacker

Page 484

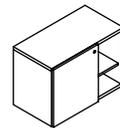

Open with Cubbies

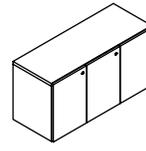

All Closed

## H T S S G Single Writable Hinged Door Stacker

Page 488

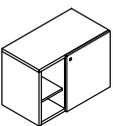

Open with Cubbies

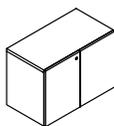

All Closed

## H T S S D Shared Solid Hinged Door Stacker

Page 490

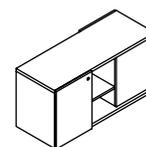
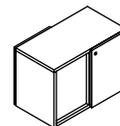

# storage product map

## H T S S P Shared Writable Hinged Door Stacker

Page 492

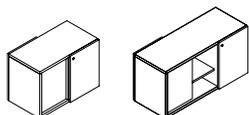

## H T S C J Stage Single Credenza

Page 493

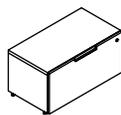

## H T S C W Stage Double Credenza

Page 494

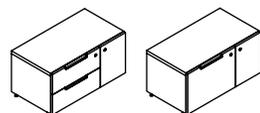

Box, Box/Hinged Door (BH)

File/Hinged Door (FH)

## H T S C U Stage Shared Double Credenza

Page 496

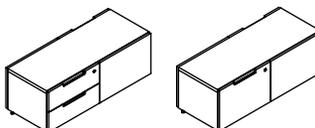

Box, Box (B)

File (F)

## H T S C Z Stage Triple Credenza

Page 498

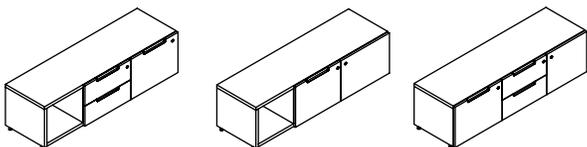

Cubby/Box, Box/ File (CBF)

Cubby/File/ Hinged Door (CFH)

File/Box, Box/ Hinged Door (FBH)

## H T S C V Stage Shared Triple Credenza

Page 500

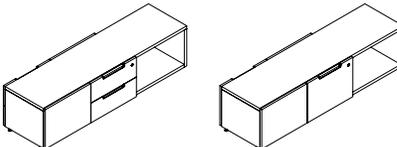

Box, Box (B)

File (F)

## H T S C Y Elevated Double Credenza

Page 502



Box, Box/Cubby (BC)

Box, Box/Hinged Door (BH)

File/Cubby (FC)

## H T S C X Elevated Triple Credenza

Page 506

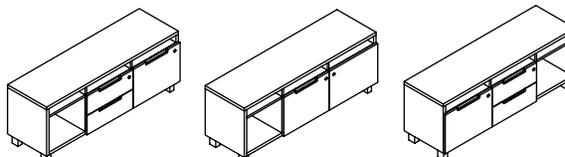

Cubby/Box, Box/ File (CBF)

Cubby/File/Hinged Door (CFH)

File/Box, Box/ Cubby (FBC)

# storage product map

## H T S C R Elevated Shared Double Credenza

Page 508

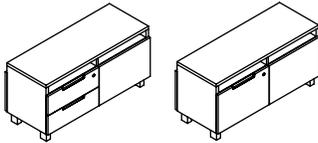

Box, Box (B)

File (F)

## H T S C Q Elevated Shared Triple Credenza

Page 510

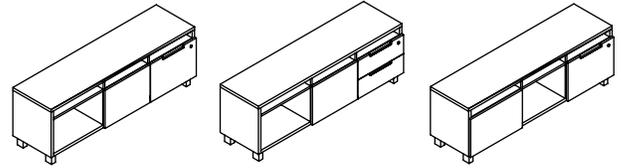

Side Open Through, Right File Drawer

Side Open Through, Right Box/Box Drawers

Center Open Through, Right File Drawer

## H T S L Lockers

Page 512

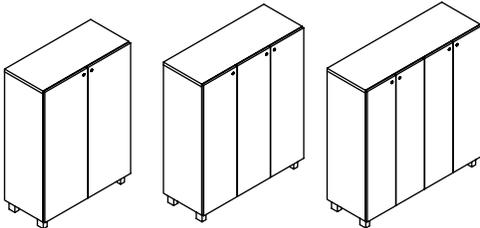

Dual, Push Latch

Triple, Push Latch

Quad, Push Latch

## H T S L C Cubby Lockers

Page 514

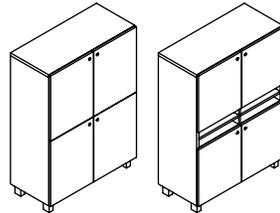

Hinged Door, Push Latch

Hinged Door with Mail Slots, Push Latch

## H T S M Mobile Pedestal

Page 516

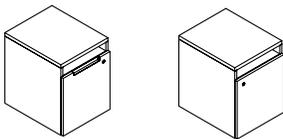

File Drawer

Hinged Door

## H T S T Lateral Tower

Page 518

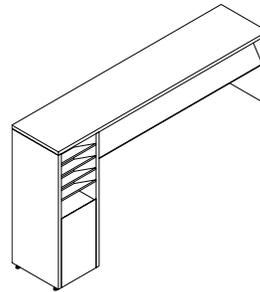

## H T S F T Side Filer

Page 520

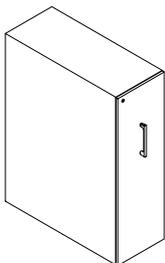

## H T S F S Mini Side Filer

Page 524

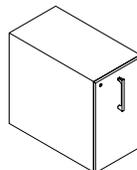

## storage product map

**H T A B Storage Cube**

Page 526





## HTSB

### Bookcase Stacker

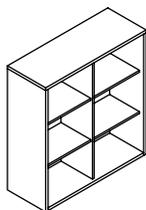

Single

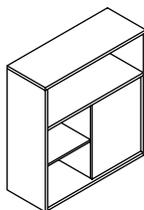

Shared, Open Through Top

#### WHAT'S INCLUDED

1 case, height adj. shelves (depending on height), double face tape.

#### WHAT'S EXCLUDED

Fascia add-ons, see Storage Accessories section.

#### NOTES

The Shelves with Open Through Top (B) configuration is only available in height of 45" and widths 30" - 72".

The Single (S) style is only available in widths 24" - 48".

The Shared (D) style is only available in widths 30" - 72".

Height 45" is only available if width 30" - 72" is selected.

Handedness Left (L) or Right (R) must be specified if the Shared (D) style is selected.

Bookcase Fascia Add-Ons (HTAN) can be ordered separately, see *Storage Accessories* section.

#### PRODUCT OPTIONS

Style	Configuration	Height	Width	Handedness	Case & Secondary Finish	Secondary Finish Application
<b>S</b> Single	<b>A</b> Shelves	21, 30, 45	24, 30, 36, 42, 48, 54, 60, 66, 72	<b>N</b> Not Applicable	Source Laminate	<b>A</b> Shelves
<b>D</b> Shared	<b>B</b> Shelves with Open Through Top			<b>L</b> Left <b>R</b> Right	Flintwood Veneer	<b>B</b> Back <b>C</b> Shelves & Back

#### SAMPLE ORDER CODE

<b>HTSB D</b>	<b>A</b>	<b>30</b>	<b>36</b>	<b>R</b>	<b>ZA</b>	<b>ZA</b>	<b>C</b>
---------------	----------	-----------	-----------	----------	-----------	-----------	----------

#### DIMENSIONS INCHES / MM

H	W
21 / 533	24 / 610
21 / 533	30 / 762
21 / 533	36 / 914
21 / 533	42 / 1066
21 / 533	48 / 1219
30 / 762	24 / 610
30 / 762	30 / 762
30 / 762	36 / 914
30 / 762	42 / 1066
30 / 762	48 / 1219
45 / 1143	30 / 762
45 / 1143	36 / 914
45 / 1143	42 / 1066
45 / 1143	48 / 1219

#### PRICING

##### SINGLE (S)

##### SHELVES (A)

Source Laminate	Flintwood	Veneer
993	2131	2237
1044	2386	2506
1090	2722	2857
1206	3060	3215
1305	3398	3568
1147	2357	2476
1142	2665	2797
1200	3060	3214
1327	3458	3629
1434	3856	4047
1434	3570	3750
1499	4000	4201
1659	4477	4704
1792	5016	5268

##### SHELVES WITH OPEN THROUGH TOP (B)

Source Laminate	Flintwood	Veneer
1434	3638	3818
1499	4073	4278
1659	4562	4792
1792	5109	5364

Pricing is continued on the following page.



**HTSB**  
**Bookcase Stacker (Continued)**

**DIMENSIONS**  
**INCHES / MM**

H	W
21 / 533	30 / 762
21 / 533	36 / 914
21 / 533	42 / 1066
21 / 533	48 / 1219
21 / 533	54 / 1372
21 / 533	60 / 1524
21 / 533	66 / 1676
21 / 533	72 / 1829
30 / 762	30 / 762
30 / 762	36 / 914
30 / 762	42 / 1066
30 / 762	48 / 1219
30 / 762	54 / 1372
30 / 762	60 / 1524
30 / 762	66 / 1676
30 / 762	72 / 1829
45 / 1143	30 / 762
45 / 1143	36 / 914
45 / 1143	42 / 1066
45 / 1143	48 / 1219
45 / 1143	54 / 1372
45 / 1143	60 / 1524
45 / 1143	66 / 1676
45 / 1143	72 / 1829

**PRICING**

<b>SHARED (D)</b>		
<b>SHELVES (A)</b>		
Source Laminate	Flintwood	Veneer
1069	3064	3217
1136	3254	3417
1206	3473	3646
1286	3692	3878
1381	3911	4106
1483	4131	4339
1587	4349	4565
1680	4571	4798
1174	3385	3552
1250	3631	3812
1328	3880	4073
1415	4128	4336
1520	4374	4592
1629	4620	4852
1744	4871	5110
1848	5110	5364
1468	4456	4678
1561	4804	5046
1660	5156	5416
1768	5508	5783
1901	5858	6152
2039	6210	6521
2179	6560	6888
2313	6916	7262

<b>SHELVES WITH OPEN THROUGH TOP (B)</b>		
Source Laminate	Flintwood	Veneer
1468	4157	4364
1561	4466	4687
1660	4771	5011
1768	5084	5336
1901	5391	5659
2039	5698	5984
2179	6006	6308
2313	6314	6631

**H T S B S**

**Solid Door Bookcase Stacker**

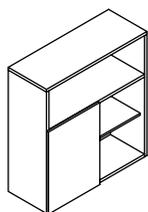

Single

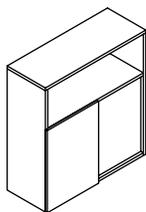

Shared, Open Through Top

**WHAT'S INCLUDED**

1 case, solid sliding door with hardware, height-adjustable shelves (depending on height), double face tape.

**WHAT'S EXCLUDED**

Fascia add-ons, see Storage Accessories section.

**NOTES**

The Shelves with Open Through Top & Solid Sliding Door Panel (K) configuration is only available in height of 45".

The Single (S) style is only available in widths 42" - 48".

Handedness Left (L) or Right (R) must be specified if the Shared (D) style is selected.

Bookcase Fascia Add-Ons (HTAN) can be ordered separately, see *Storage Accessories* section.

**PRODUCT OPTIONS**

Style	Configuration	Height	Width	Handedness	Case, Secondary & Door Finish	Secondary Finish Application
<b>S</b> Single	<b>C</b> Shelves with Solid Sliding Door Panel	30, 45	42, 48, 54, 60, 66, 72	<b>N</b> Not Applicable	Source Laminate	<b>A</b> Shelves
<b>D</b> Shared						<b>B</b> Back
	<b>K</b> Shelves with Open Through Top & Solid Sliding Door Panel			<b>R</b> Right	Veneer	<b>C</b> Shelves & Back

**SAMPLE ORDER CODE**

<b>HTSBS D</b>	<b>C</b>	<b>30</b>	<b>42</b>	<b>R</b>	<b>ZA</b>	<b>ZA</b>	<b>ZA</b>	<b>B</b>
----------------	----------	-----------	-----------	----------	-----------	-----------	-----------	----------

**DIMENSIONS  
INCHES / MM**

H	W
30 / 762	42 / 1066
30 / 762	48 / 1219
45 / 1143	42 / 1066
45 / 1143	48 / 1219

**PRICING**

<b>SINGLE (S)</b>			
<b>SHELVES WITH SOLID SLIDING DOOR PANEL (C)</b>			
SOURCE LAMINATE	FLINTWOOD	VENEER	
Case, Secondary & Front	Case, Secondary & Flintwood Front	Case, Secondary & Front	Case, Secondary & Front
1536	1597	3726	3914
1656	1721	4140	4348
1914	1992	4812	5055
2067	2149	5374	5644
<b>SHELVES WITH OPEN THROUGH TOP &amp; SOLID SLIDING DOOR PANEL (K)</b>			
SOURCE LAMINATE	FLINTWOOD	VENEER	
Case, Secondary & Front	Case, Secondary & Flintwood Front	Case, Secondary & Front	Case, Secondary & Front
1867	1928	4830	5074
2014	2079	5396	5667

Pricing is continued on the following page.

**H T S B S**  
**Solid Door Bookcase Stacker**  
**(Continued)**

**DIMENSIONS**  
**INCHES / MM**

H	W
30 / 762	42 / 1066
30 / 762	48 / 1219
30 / 762	54 / 1372
30 / 762	60 / 1524
30 / 762	66 / 1676
30 / 762	72 / 1829
45 / 1143	42 / 1066
45 / 1143	48 / 1219
45 / 1143	54 / 1372
45 / 1143	60 / 1524
45 / 1143	66 / 1676
45 / 1143	72 / 1829

**PRICING**

**SHARED (D)**  
**SHELVES WITH SOLID SLIDING DOOR PANEL (C)**

SOURCE LAMINATE		FLINTWOOD	veneer
Case, Secondary & Front	Case, Secondary & Flintwood Front	Case, Secondary & Front	Case, Secondary & Front
1744	1868	4420	4641
1854	1989	4700	4936
1989	2131	4981	5230
2124	2269	5264	5524
2261	2419	5543	5822
2394	2559	5817	6110
2172	2326	5823	6113
2317	2483	6223	6533
2488	2664	6622	6953
2662	2848	7019	7370
2839	3036	7418	7788
3010	3218	7821	8213

**SHELVES WITH OPEN THROUGH TOP & SOLID SLIDING DOOR PANEL (K)**

SOURCE LAMINATE		FLINTWOOD	veneer
Case, Secondary & Front	Case, Secondary & Flintwood Front	Case, Secondary & Front	Case, Secondary & Front
2077	2200	5313	5579
2209	2343	5656	5939
2371	2509	6001	6298
2532	2679	6340	6657
2699	2854	6684	7017
2856	3021	7023	7377

# HTSBF

## Fabric Door Bookcase Stacker

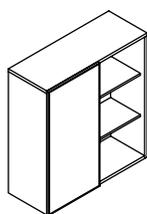

Single

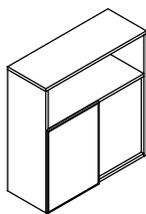

Shared, Open Through Top

### WHAT'S INCLUDED

1 case, fabric sliding door with hardware, height-adjustable shelves (depending on height), double face tape.

### WHAT'S EXCLUDED

Fascia add-ons, see Storage Accessories section.

### NOTES

The Shelves with Open Through Top & Fabric Sliding Door Panel (G) configuration is only available in height of 45".

The Single (S) style is only available in widths 42" - 48".

Handedness Left (L) or Right (R) must be specified if the Shared (D) style is selected.

Bookcase Fascia Add-Ons (HTAN) can be ordered separately, see *Storage Accessories* section.

### PRODUCT OPTIONS

Style	Configuration	Height	Width
<b>S</b> Single <b>D</b> Shared	<b>M</b> Shelves with Fabric Sliding Door Panel <b>G</b> Shelves with Open Through Top & Fabric Sliding Door Panel	30, 45	42, 48, 54, 60, 66, 72

### SAMPLE ORDER CODE

<b>HTSBF D</b>	<b>M</b>	<b>45</b>	<b>42</b>
----------------	----------	-----------	-----------

### PRODUCT OPTIONS (CONTINUED)

Handedness	Case & Secondary Finish	Secondary Finish Application	Sliding Door Finish	Door Trim Finish
<b>N</b> Not Applicable <b>L</b> Left <b>R</b> Right	Source Laminate Flintwood Veneer	<b>A</b> Shelves <b>B</b> Back <b>C</b> Shelves & Back	Panel Fabric	<b>AC</b> Clear Anodized <b>BP</b> Espresso Painted <b>83</b> Very White Painted

### SAMPLE ORDER CODE (CONTINUED)

<b>R</b>	<b>ZA</b>	<b>ZA</b>	<b>C</b>	<b>V512</b>	<b>AC</b>
----------	-----------	-----------	----------	-------------	-----------

See Pricing on the following page.

**H T S B F**  
**Fabric Door Bookcase Stacker**  
**(Continued)**

**DIMENSIONS**  
**INCHES / MM**

H	W
30 / 762	42 / 1066
30 / 762	48 / 1219
45 / 1143	42 / 1066
45 / 1143	48 / 1219

H	W
45 / 1143	42 / 1066
45 / 1143	48 / 1219

H	W
30 / 762	42 / 1066
30 / 762	48 / 1219
30 / 762	54 / 1372
30 / 762	60 / 1524
30 / 762	66 / 1676
30 / 762	72 / 1829
45 / 1143	42 / 1066
45 / 1143	48 / 1219
45 / 1143	54 / 1372
45 / 1143	60 / 1524
45 / 1143	66 / 1676
45 / 1143	72 / 1829

H	W
45 / 1143	42 / 1066
45 / 1143	48 / 1219
45 / 1143	54 / 1372
45 / 1143	60 / 1524
45 / 1143	66 / 1676
45 / 1143	72 / 1829

**PRICING**

**SINGLE (S)**  
**SHELVES WITH FABRIC SLIDING DOOR PANEL (M)**

Source Laminate	Flintwood	Veneer
1327	3458	3629
1434	3856	4047
1659	4477	4704
1792	5016	5268

**SHELVES WITH OPEN THROUGH TOP & FABRIC SLIDING DOOR PANEL (G)**

Source Laminate	Flintwood	Veneer
1659	4562	4792
1792	5109	5364

**SHARED (D)**  
**SHELVES WITH FABRIC SLIDING DOOR PANEL (M)**

Source Laminate	Flintwood	Veneer
1328	3880	4073
1415	4128	4336
1520	4374	4592
1629	4620	4852
1744	4871	5110
1848	5110	5364
1660	5156	5416
1768	5508	5783
1901	5858	6152
2039	6210	6521
2179	6560	6888
2313	6916	7262

**SHELVES WITH OPEN THROUGH TOP & FABRIC SLIDING DOOR PANEL (G)**

Source Laminate	Flintwood	Veneer
1660	4771	5011
1768	5084	5336
1901	5391	5659
2039	5698	5984
2179	6006	6308
2313	6314	6631

Pricing is continued on the following page.

**H T S B F**

**Fabric Door Bookcase Stacker  
(Continued)**

**DIMENSIONS  
INCHES / MM**

**PRICING**

IF FABRIC IS SPECIFIED ADD THE FOLLOWING:

		<b>SINGLE (S)</b>								<b>SINGLE (S)</b>							
		<b>SHELVES WITH FABRIC SLIDING DOOR PANEL (M)</b>								<b>SHELVES WITH OPEN THROUGH TOP &amp; FABRIC SLIDING DOOR PANEL (G)</b>							
		COM/								COM/							
H	W	Gr. A	Gr. 1	Gr. 2	Gr. 3	Gr. 4	Gr. 5	Gr. 6	Gr. 7	Gr. A	Gr. 1	Gr. 2	Gr. 3	Gr. 4	Gr. 5	Gr. 6	Gr. 7
30 / 762	42 / 1066	429	447	464	484	505	523	543	566	n/a	n/a	n/a	n/a	n/a	n/a	n/a	n/a
30 / 762	48 / 1219	451	469	487	506	527	545	569	593	n/a	n/a	n/a	n/a	n/a	n/a	n/a	n/a
45 / 1143	42 / 1066	461	482	500	518	541	563	586	609	429	447	464	484	505	523	543	566
45 / 1143	48 / 1219	487	506	529	545	567	593	616	640	451	469	487	506	527	545	569	593
		<b>SHARED (D)</b>								<b>SHARED (D)</b>							
		<b>SHELVES WITH FABRIC SLIDING DOOR PANEL (M)</b>								<b>SHELVES WITH OPEN THROUGH TOP &amp; FABRIC SLIDING DOOR PANEL (G)</b>							
		COM/								COM/							
H	W	Gr. A	Gr. 1	Gr. 2	Gr. 3	Gr. 4	Gr. 5	Gr. 6	Gr. 7	Gr. A	Gr. 1	Gr. 2	Gr. 3	Gr. 4	Gr. 5	Gr. 6	Gr. 7
30 / 762	42 / 1066	860	896	931	967	1009	1047	1088	1133	n/a	n/a	n/a	n/a	n/a	n/a	n/a	n/a
30 / 762	48 / 1219	901	934	973	1012	1053	1095	1139	1183	n/a	n/a	n/a	n/a	n/a	n/a	n/a	n/a
30 / 762	54 / 1372	939	977	1017	1057	1099	1142	1189	1236	n/a	n/a	n/a	n/a	n/a	n/a	n/a	n/a
30 / 762	60 / 1524	979	1019	1060	1102	1146	1193	1241	1289	n/a	n/a	n/a	n/a	n/a	n/a	n/a	n/a
30 / 762	66 / 1676	1019	1060	1102	1146	1195	1241	1289	1340	n/a	n/a	n/a	n/a	n/a	n/a	n/a	n/a
30 / 762	72 / 1829	1058	1101	1144	1195	1242	1288	1340	1392	n/a	n/a	n/a	n/a	n/a	n/a	n/a	n/a
45 / 1143	42 / 1066	926	962	1001	1042	1084	1127	1172	1218	860	896	931	967	1009	1047	1088	1133
45 / 1143	48 / 1219	971	1012	1053	1093	1140	1183	1230	1282	901	934	973	1012	1053	1095	1139	1183
45 / 1143	54 / 1372	1021	1061	1104	1147	1196	1242	1290	1343	939	977	1017	1057	1099	1142	1189	1236
45 / 1143	60 / 1524	1069	1110	1153	1200	1250	1299	1350	1406	979	1019	1060	1102	1146	1193	1241	1289
45 / 1143	66 / 1676	1115	1160	1206	1256	1305	1357	1411	1467	1019	1060	1102	1146	1195	1241	1289	1340
45 / 1143	72 / 1829	1163	1208	1258	1308	1359	1415	1470	1530	1058	1101	1144	1195	1242	1288	1340	1392



# HTSBW

## Writable Door Bookcase Stacker

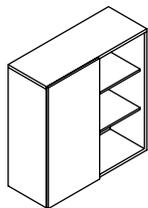

Single

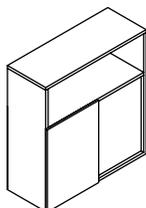

Shared, Open Through Top

### WHAT'S INCLUDED

1 case, framed glass sliding door with hardware, height-adjustable shelves (depending on height), double face tape.

### WHAT'S EXCLUDED

Fascia add-ons, see Storage Accessories section.

### NOTES

The Shelves with Open Through Top & BP Glass Sliding Door Panel (V) configuration is only available in height of 45".

The Single (S) style is only available in widths 42" - 48".

Handedness Left (L) or Right (R) must be specified if the Shared (D) style is selected.

Bookcase Fascia Add-Ons (HTAN) can be ordered separately, see *Storage Accessories* section.

Glass frame finish coordinates with the finish of the glass.

### PRODUCT OPTIONS

Style	Configuration	Height	Width	Handedness	Case & Secondary Finish	Secondary Finish Application	Sliding Door Finish
<b>S</b> Single	<b>R</b> Shelves with BP Glass Sliding Door Panel	30, 45	42, 48, 54, 60, 66, 72	<b>N</b> Not Applicable	Source Laminate	<b>A</b> Shelves	<b>K1</b> Storm White
<b>D</b> Shared	<b>V</b> Shelves with Open Through Top & BP Glass Sliding Door Panel			<b>L</b> Left <b>R</b> Right	Flintwood Veneer	<b>B</b> Back <b>C</b> Shelves & Back	<b>K7</b> Very White <b>J6</b> Gris

### SAMPLE ORDER CODE

<b>HTSBW D</b>	<b>R</b>	<b>45</b>	<b>60</b>	<b>R</b>	<b>ZA</b>	<b>ZA</b>	<b>A</b>	<b>J6</b>
----------------	----------	-----------	-----------	----------	-----------	-----------	----------	-----------

### DIMENSIONS INCHES / MM

H	W
30 / 762	42 / 1066
30 / 762	48 / 1219
45 / 1143	42 / 1066
45 / 1143	48 / 1219

### PRICING

#### SINGLE (S)

#### SHELVES WITH BP GLASS SLIDING DOOR PANEL (R)

Source Laminate	Flintwood	Veneer
1906	4038	4209
2055	4474	4668
2419	5240	5464
2609	5833	6084

#### SHELVES WITH OPEN THROUGH TOP & BP GLASS SLIDING DOOR PANEL (V)

Source Laminate	Flintwood	Veneer
2238	5143	5370
2413	5730	5986

Pricing is continued on the following page.



**H T S B W**  
**Writable Door Bookcase Stacker**  
**(Continued)**

**DIMENSIONS**  
**INCHES / MM**

H	W
30 / 762	42 / 1066
30 / 762	48 / 1219
30 / 762	54 / 1372
30 / 762	60 / 1524
30 / 762	66 / 1676
30 / 762	72 / 1829
45 / 1143	42 / 1066
45 / 1143	48 / 1219
45 / 1143	54 / 1372
45 / 1143	60 / 1524
45 / 1143	66 / 1676
45 / 1143	72 / 1829

**PRICING**

**SHARED (D)**  
**SHELVES WITH BP GLASS SLIDING DOOR PANEL (R)**

Source Laminate	Flintwood	Veneer
2484	5037	5229
2657	5366	5574
2846	5698	5916
3038	6029	6261
3234	6360	6602
3425	6687	6938
3183	6679	6937
3399	7140	7414
3645	7601	7894
3892	8062	8373
4141	8524	8853
4385	8988	9334

**SHELVES WITH OPEN THROUGH TOP & BP GLASS SLIDING DOOR PANEL (V)**

Source Laminate	Flintwood	Veneer
2817	5931	6171
3010	6322	6577
3226	6716	6987
3445	7109	7392
3670	7500	7802
3888	7889	8205

# HTSBV

## Variable Bookcase Stacker

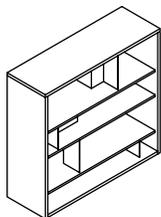

Variable Bookcase is a collaborative space division solution that has fixed in place tall and low dividers and optional bookends.

### WHAT'S INCLUDED

1 case, fixed tall dividers, a low dividers, double face tape.  
(see Application Guides for quantity details)

### NOTES

Removable Bookends (HTAD) can be ordered separately, see *Storage Accessories* section.

Tall Dividers are tall and narrow, at 66" and 42" datum. Low Dividers are short and wide at 51" and 29" datum.

### PRODUCT OPTIONS

Height	Width	Case & Secondary Finish	Tall Divider Finish	Low Divider Finish
21, 30, 45	30, 36, 42, 48, 54, 60, 66, 72	Source Laminate Flintwood Veneer	Foundation Mica Accent	Foundation Mica Accent

### SAMPLE ORDER CODE

<b>HTSBV 45</b>	<b>36</b>	<b>ZA</b>	<b>ZA</b>	<b>74</b>	<b>74</b>
-----------------	-----------	-----------	-----------	-----------	-----------

### DIMENSIONS INCHES / MM

H	W
21 / 533	30 / 762
21 / 533	36 / 914
21 / 533	42 / 1066
21 / 533	48 / 1219
21 / 533	54 / 1372
21 / 533	60 / 1524
21 / 533	66 / 1676
21 / 533	72 / 1829
30 / 762	30 / 762
30 / 762	36 / 914
30 / 762	42 / 1066
30 / 762	48 / 1219
30 / 762	54 / 1372
30 / 762	60 / 1524
30 / 762	66 / 1676
30 / 762	72 / 1829

### PRICING

Source Laminate	Flintwood	Veneer
1290	2370	2487
1339	2604	2734
1455	2866	3008
1551	3151	3308
1628	3468	3640
1712	3812	4006
1795	4193	4404
1886	4613	4846
1540	2488	2613
1594	2735	2875
1719	3010	3161
1828	3309	3475
1918	3641	3827
2014	4007	4205
2115	4405	4626
2220	4849	5090

If Mica/Accent Divider is specified, 21" high add 6  
 30" high add 8  
 45" high add 14

Pricing is continued on the following page.

**HTSBV**  
**Variable Bookcase Stacker**  
**(Continued)**

**DIMENSIONS**  
**INCHES / MM**

**PRICING**

H	W	Source Laminate	Flintwood	Veneer
45 / 1143	30 / 762	1929	3554	3731
45 / 1143	36 / 914	1997	3984	4185
45 / 1143	42 / 1066	2154	4413	4634
45 / 1143	48 / 1219	2289	4841	5085
45 / 1143	54 / 1372	2404	5270	5531
45 / 1143	60 / 1524	2523	5697	5983
45 / 1143	66 / 1676	2648	6125	6430
45 / 1143	72 / 1829	2780	6551	6878

If Mica/Accent Divider is specified, 21" high add 6  
 30" high add 8  
 45" high add 14

**HTSSS**

**Single Solid Hinged Door Stacker**

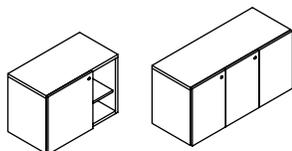

With Open Cubbies All Closed

**WHAT'S INCLUDED**

1 case, hinged doors, handle (if specified), height-adjustable shelves (depending on height), lock and keys (if specified), double face tape.

**WHAT'S EXCLUDED**

Fascia add-ons, see Storage Accessories section.

**NOTES**

If All Closed (N) style is specified, third door will be added for widths 42" - 48".

If With Open Cubbies (C) style is specified, all widths include open cubbies situated either on the left or right of the closed section.

Hinged Door Stacker Fascia Add-Ons (HTAZ) can be ordered separately, see *Storage Accessories* section.

**PRODUCT OPTIONS**

Height	Width	Style	Third Door/ Cubbies Location	Pull Style	Pull Finish	Case, Secondary & Front Finish	Secondary Finish Application	Key
21, 30, 45	30, 36, 42, 48	<b>N</b> All Closed <b>C</b> With Open Cubbies	<b>N</b> Not Applicable <b>L</b> Left <b>R</b> Right	<b>P</b> Push Latch <b>X</b> upStage Handle	<b>NN</b> Not Applicable (for Push Latch only) Foundation Mica Accent	Source Laminate Flintwood Veneer	<b>A</b> Shelves <b>B</b> Back <b>C</b> Shelves & Back	<b>N</b> No Key <b>K</b> Key Alike <b>R</b> Key Random

**SAMPLE ORDER CODE**

<b>HTSSS 30</b>	<b>42</b>	<b>C</b>	<b>L</b>	<b>X</b>	<b>74</b>	<b>ZA</b>	<b>ZA</b>	<b>ZA</b>	<b>B</b>	<b>K</b>
-----------------	-----------	----------	----------	----------	-----------	-----------	-----------	-----------	----------	----------

**DIMENSIONS  
INCHES / MM**

H	W
21 / 533	36 / 918
21 / 533	44 / 1101
21 / 533	51 / 1285
21 / 533	58 / 1469
30 / 762	36 / 918
30 / 762	44 / 1101
30 / 762	51 / 1285
30 / 762	58 / 1469
45 / 1143	36 / 918
45 / 1143	44 / 1101
45 / 1143	51 / 1285
45 / 1143	58 / 1469

**PRICING**

<b>ALL CLOSED (N)</b>			
<b>PUSH LATCH (P)</b>			
<b>SOURCE LAMINATE</b>		<b>FLINTWOOD</b>	<b>VENEER</b>
Case, Secondary & Front	Case, Secondary & Flintwood Front	Case Secondary & Front	Case Secondary & Front
1434	1865	3613	3797
1506	1956	3950	4144
1655	2150	4285	4498
1738	2258	4619	4851
1547	2013	4128	4336
1625	2112	4510	4733
1787	2322	4888	5135
1877	2440	5272	5535
1883	2449	5364	5634
2074	2692	5795	6084
2282	2962	6223	6533
2393	3110	6649	6983

Pricing is continued on the following page.

**H T S S S**  
**Single Solid Hinged Door Stacker**  
**(Continued)**

**DIMENSIONS**  
**INCHES / MM**

H	W
21 / 533	30 / 762
21 / 533	36 / 914
21 / 533	42 / 1066
21 / 533	48 / 1219
30 / 762	30 / 762
30 / 762	36 / 914
30 / 762	42 / 1066
30 / 762	48 / 1219
45 / 1143	30 / 762
45 / 1143	36 / 914
45 / 1143	42 / 1066
45 / 1143	48 / 1219

**PRICING**

<b>ALL CLOSED (N) (Continued)</b>			
<b>UPSTAGE HANDLE (X)</b>			
<b>SOURCE LAMINATE</b>		<b>FLINTWOOD</b>	<b>VENEER</b>
Case, Secondary & Front	Case, Secondary & Flintwood Front	Case Secondary & Front	Case Secondary & Front
1509	1961	3689	3873
1581	2055	4023	4227
1768	2298	4398	4618
1850	2408	4733	4971
1624	2111	4203	4413
1701	2210	4585	4814
1901	2472	5005	5255
1992	2589	5387	5655
1960	2547	5440	5712
2148	2794	5869	6164
2393	3112	6337	6654
2508	3260	6763	7102

<b>WITH OPEN CUBBIES (C)</b>			
<b>PUSH LATCH (P)</b>			
<b>SOURCE LAMINATE</b>		<b>FLINTWOOD</b>	<b>VENEER</b>
Case, Secondary & Front	Case, Secondary & Flintwood Front	Case Secondary & Front	Case Secondary & Front
1289	1675	3307	3472
1354	1761	3628	3809
1490	1936	3952	4145
1564	2032	4269	4484
1392	1809	3724	3910
1462	1901	4103	4308
1610	2089	4477	4704
1688	2197	4854	5097
1696	2205	5010	5264
1866	2424	5397	5668
2051	2667	5783	6071
2154	2800	6170	6477

Pricing is continued on the following page.

**H T S S S**

**Single Solid Hinged Door Stacker  
(Continued)**

**DIMENSIONS  
INCHES / MM**

**PRICING**

		<b>WITH OPEN CUBBIES (C) (Continued)</b>			
		<b>UPSTAGE HANDLE (X)</b>			
		<b>SOURCE LAMINATE</b>	<b>FLINTWOOD</b>	<b>VENEER</b>	
H	W	Case, Secondary & Front	Case, Secondary & Flintwood Front	Case Secondary & Front	Case Secondary & Front
21 / 533	30 / 762	1328	1726	3345	3511
21 / 533	36 / 914	1391	1808	3667	3848
21 / 533	42 / 1066	1527	1987	4024	4227
21 / 533	48 / 1219	1600	2081	4346	4562
30 / 762	30 / 762	1432	1861	3761	3952
30 / 762	36 / 914	1499	1952	4138	4347
30 / 762	42 / 1066	1647	2139	4585	4814
30 / 762	48 / 1219	1727	2245	4932	5180
45 / 1143	30 / 762	=1731	2254	5050	5302
45 / 1143	36 / 914	1903	2473	5436	5708
45 / 1143	42 / 1066	2088	2717	5859	6152
45 / 1143	48 / 1219	2192	2850	6243	6555



# HTSSG

## Single Writable Hinged Door Stacker

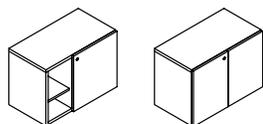

Open with  
Cubbies

All Closed

### PRODUCT OPTIONS

Height	Width	Style	Third Door/ Cubbies Location	Pull Style	Case & Secondary Finish	Secondary Finish Application	Door Finish	Key
21, 30, 45	30, 36, 42, 48	<b>N</b> All Closed <b>C</b> With Open Cubbies	<b>N</b> Not Applicable <b>L</b> Left <b>R</b> Right	<b>P</b> Push Latch	Source Laminate Flintwood Veneer	<b>A</b> Shelves <b>B</b> Back <b>C</b> Shelves & Back	<b>K1</b> Storm White <b>K7</b> Very White <b>J6</b> Gris	<b>N</b> No Key <b>K</b> Key Alike <b>R</b> Key Random

### SAMPLE ORDER CODE

<b>HTSSG 30</b>	<b>42</b>	<b>C</b>	<b>L</b>	<b>P</b>	<b>ZA</b>	<b>ZA</b>	<b>A</b>	<b>J6</b>	<b>K</b>
-----------------	-----------	----------	----------	----------	-----------	-----------	----------	-----------	----------

### DIMENSIONS INCHES / MM

H	W
21 / 533	30 / 762
21 / 533	36 / 914
21 / 533	42 / 1066
21 / 533	48 / 1219
30 / 762	30 / 762
30 / 762	36 / 914
30 / 762	42 / 1066
30 / 762	48 / 1219
45 / 1143	30 / 762
45 / 1143	36 / 914
45 / 1143	42 / 1066
45 / 1143	48 / 1219

### PRICING

#### ALL CLOSED (N)

Source Laminate	Flintwood	Veneer
1865	3613	3757
1956	3950	4105
2150	4285	4454
2258	4619	4801
2013	4128	4289
2112	4510	4685
2322	4888	5085
2440	5272	5479
2449	5364	5576
2692	5795	6023
2962	6223	6470
3110	6649	6912

Pricing is continued on the following page.



**HTSSG**  
**Single Writable Hinged Door**  
**Stacker (Continued)**

**DIMENSIONS**  
**INCHES / MM**

H	W
21 / 533	30 / 762
21 / 533	36 / 914
21 / 533	42 / 1066
21 / 533	48 / 1219
30 / 762	30 / 762
30 / 762	36 / 914
30 / 762	42 / 1066
30 / 762	48 / 1219
45 / 1143	30 / 762
45 / 1143	36 / 914
45 / 1143	42 / 1066
45 / 1143	48 / 1219

**PRICING**

**WITH OPEN CUBBIES (C)**

Source Laminate	Flintwood	Veneer
1675	3307	3436
1761	3628	3773
1936	3952	4106
2032	4269	4438
1809	3724	3872
1901	4103	4263
2089	4477	4654
2197	4854	5049
2205	5010	5212
2424	5397	5611
2667	5783	6013
2800	6170	6412

# HTSSD

## Shared Solid Hinged Door Stacker

### WHAT'S INCLUDED

1 case, hinged doors, handle (if specified), height-adjustable shelves (depending on height), lock and keys (if specified), double face tape.

### WHAT'S EXCLUDED

Fascia add-ons, see Storage Accessories section.

### NOTES

Hinged Door Stacker Fascia Add-Ons (HTAZ) can be ordered separately, see *Storage Accessories* section.

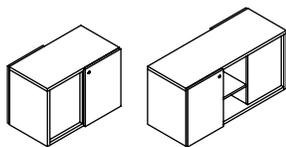

### PRODUCT OPTIONS

Height	Width	Door Location	Pull Style	Pull Finish	Case, Secondary & Front Finish	Secondary Finish Application	Key
21, 30, 45	30, 36, 42, 48	L Left R Right	P Push Latch X upStage Handle	NN Not Applicable (for Push Latch only) Foundation Mica Accent	Source Laminate Flintwood Veneer	A Shelves B Back C Shelves & Back	N No Key K Key Alike R Key Random

### SAMPLE ORDER CODE

<b>HTSSD 30</b>	<b>42</b>	<b>L</b>	<b>P</b>	<b>74</b>	<b>ZA</b>	<b>ZA</b>	<b>ZA</b>	<b>A</b>	<b>K</b>
-----------------	-----------	----------	----------	-----------	-----------	-----------	-----------	----------	----------

### DIMENSIONS INCHES / MM

H	W
21 / 533	30 / 762
21 / 533	36 / 914
21 / 533	42 / 1066
21 / 533	48 / 1219
30 / 762	30 / 762
30 / 762	36 / 914
30 / 762	42 / 1066
30 / 762	48 / 1219
45 / 1143	30 / 762
45 / 1143	36 / 914
45 / 1143	42 / 1066
45 / 1143	48 / 1219

### PRICING

PUSH LATCH (P)			
SOURCE LAMINATE		FLINTWOOD	VENEER
Case, Secondary & Front	Case, Secondary & Flintwood Front	Case, Secondary & Front	Case, Secondary & Front
1398	1820	3870	4061
1625	2111	4091	4295
1705	2215	4415	4637
1791	2328	4738	4977
1621	2107	4316	4530
1735	2255	4639	4871
1854	2413	4957	5206
1987	2584	5278	5544
1969	2560	5411	5682
2107	2740	5882	6176
2255	2930	6350	6668
2413	3136	6818	7161

Pricing is continued on the following page.

**HTSSD**  
**Shared Solid Hinged Door Stacker**  
**(Continued)**

**DIMENSIONS**  
**INCHES / MM**

**PRICING**

		UPSTAGE HANDLE (X)			
		SOURCE LAMINATE		FLINTWOOD	VENEER
H	W	Case, Secondary & Front	Case, Secondary & Flintwood Front	Case, Secondary & Front	Case, Secondary & Front
21 / 533	30 / 762	1475	1919	3947	4141
21 / 533	36 / 914	1701	2210	4167	4376
21 / 533	42 / 1066	1781	2315	4491	4715
21 / 533	48 / 1219	1868	2427	4816	5057
30 / 762	30 / 762	1698	2207	4394	4612
30 / 762	36 / 914	1809	2355	4713	4948
30 / 762	42 / 1066	1930	2511	5033	5285
30 / 762	48 / 1219	2061	2680	5356	5624
45 / 1143	30 / 762	2047	2660	5486	5762
45 / 1143	36 / 914	2183	2839	5958	6254
45 / 1143	42 / 1066	2330	3031	6425	6748
45 / 1143	48 / 1219	2490	3234	6895	7239

**HTSSP**

**Shared Writable Hinged Door Stacker**

**WHAT'S INCLUDED**

1 case, hinged doors, push latch, height-adjustable shelves (depending on height), lock and keys (if specified), double face tape.

**WHAT'S EXCLUDED**

Fascia add-ons, see Storage Accessories section.

**NOTES**

Hinged Door Stacker Fascia Add-Ons (HTAZ) can be ordered separately, see *Storage Accessories* section.

Glass frame finish coordinates with the finish of the glass.

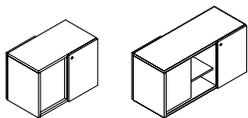

**PRODUCT OPTIONS**

Height	Width	Door Location	Pull Style	Case & Secondary Finish	Secondary Finish Application	Door Finish	Key
21, 30, 45	30, 36, 42, 48	<b>L</b> Left <b>R</b> Right	<b>P</b> Push Latch	Source Laminate Flintwood Veneer	<b>A</b> Shelves <b>B</b> Back <b>C</b> Shelves & Back	<b>K1</b> Storm White <b>K7</b> Very White <b>J6</b> Gris	<b>N</b> No Key <b>K</b> Key Alike <b>R</b> Key Random

**SAMPLE ORDER CODE**

<b>HTSSP 30</b>	<b>42</b>	<b>L</b>	<b>P</b>	<b>ZA</b>	<b>ZA</b>	<b>A</b>	<b>J6</b>	<b>K</b>
-----------------	-----------	----------	----------	-----------	-----------	----------	-----------	----------

**DIMENSIONS  
INCHES / MM**

H	W
21 / 533	30 / 762
21 / 533	36 / 914
21 / 533	42 / 1066
21 / 533	48 / 1219
30 / 762	30 / 762
30 / 762	36 / 914
30 / 762	42 / 1066
30 / 762	48 / 1219
45 / 1143	30 / 762
45 / 1143	36 / 914
45 / 1143	42 / 1066
45 / 1143	48 / 1219

**PRICING**

Source Laminate	Flintwood	Veneer
1820	3870	4022
2111	4091	4255
2215	4415	4590
2328	4738	4927
2107	4316	4487
2255	4639	4821
2413	4957	5153
2584	5278	5487
2560	5411	5627
2740	5882	6115
2930	6350	6601
3136	6818	7089

**WHAT'S INCLUDED**

Case with file drawer, levelers, counterweights.

**NOTES**

Must be planned under the stage.

**HTSCJ**  
**Stage Single Credenza**

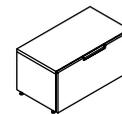

**PRODUCT OPTIONS**

Width	Pull Style	Pull Finish	Case & Back, Front Finish	Key
24, 30, 36	X upStage Handle	Foundation Mica Accent	Source Laminate Flintwood Veneer	N No Key K Key Alike R Key Random

**SAMPLE ORDER CODE**

<b>HTSCJ 36</b>	<b>X</b>	<b>74</b>	<b>ZA</b>	<b>ZA</b>	<b>K</b>
-----------------	----------	-----------	-----------	-----------	----------

**DIMENSIONS  
INCHES / MM**

W
24 / 610
30 / 762
36 / 914

**PRICING**

SOURCE LAMINATE		FLINTWOOD	VENEER
Case, Back & Front	Case & Back, Flintwood Front	Case, Back & Front	Case, Back & Front
1340	1784	2289	2405
1411	1876	2409	2531
1526	2028	2602	2733

# HTSCW

## Stage Double Credenza

### WHAT'S INCLUDED

Case and drawers, levelers, filing accessory (if box drawers are specified), hanging bar when file drawers specified, counterweights (if specified).

### NOTES

The File/File (FF) configuration is only available in widths 42" - 48".

The File/Box, Box (FB) and File/Box, Box (BF) configurations are only available in widths 36" - 48".

If Filing Accessory for box drawer is specified, the dividers match the color of the upStage handle, while the liner defaults to Ebony (Source Laminate) or Foundation Grey (Flintwood, Veneer front).

Hinged door includes Push Latch, no handle option is available.

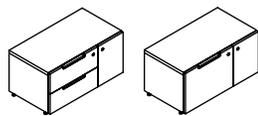

Box, Box/Hinged Door (BH)

File/Hinged Door (FH)

### PRODUCT OPTIONS

Width	Configuration	Pull Style	Pull Finish	Case & Back, Front Finish	Key	Counterweight	Filing Accessory
30, 36, 42, 48	<b>FH</b> File/Hinged Door	<b>X</b> upStage Handle	Foundation	Source Laminate	<b>N</b> No Key	<b>1</b> Yes	<b>Y</b> Yes
	<b>HF</b> Hinged Door/File		Mica	Flintwood	<b>K</b> Key Alike	<b>2</b> No	<b>N</b> No
	<b>BH</b> Box, Box/Hinged Door		Accent	Veneer	<b>R</b> Key Random		
	<b>HB</b> Hinged Door/Box, Box						
	<b>FF</b> File/File						
	<b>FB</b> File/Box, Box						
	<b>BF</b> Box, Box/File						

### SAMPLE ORDER CODE

<b>HTSCW 42</b>	<b>FF</b>	<b>X</b>	<b>74</b>	<b>ZA</b>	<b>ZA</b>	<b>K</b>	<b>2</b>	<b>N</b>
-----------------	-----------	----------	-----------	-----------	-----------	----------	----------	----------

### DIMENSIONS INCHES / MM

W
30 / 762
36 / 914
42 / 1066
48 / 1219

### PRICING

#### FILE/HINGED DOOR (FH) & HINGED DOOR/FILE (HF)

SOURCE LAMINATE		FLINTWOOD		VENEER	
Case, Back & Front	Case & Back, Flintwood Front	Case, Back & Front	Case, Back & Front	Case, Back & Front	Case, Back & Front
1573	2029	2788	2788	2926	2926
1620	2088	2871	2871	3013	3013
1672	2160	2962	2962	3112	3112
1721	2220	3049	3049	3202	3202

#### BOX, BOX/HINGED DOOR (BH) & HINGED DOOR/BOX, BOX (HB)

SOURCE LAMINATE		FLINTWOOD		VENEER	
Case, Back & Front	Case & Back, Flintwood Front	Case, Back & Front	Case, Back & Front	Case, Back & Front	Case, Back & Front
1749	2257	3097	3097	3252	3252
1802	2322	3191	3191	3351	3351
1856	2394	3291	3291	3455	3455
1912	2468	3388	3388	3558	3558

See Filing Accessory upcharge on the following page

Pricing is continued on the following page.

**HTSCW**  
**Stage Double Credenza (Continued)**

**DIMENSIONS**  
**INCHES / MM**

**PRICING**

W	FILE/FILE (FF)			
	SOURCE LAMINATE		FLINTWOOD	VENEER
	Case, Back & Front	Case & Back, Flintwood Front	Case, Back & Front	Case, Back & Front
42 / 1066	1845	2380	3268	3432
48 / 1219	1923	2480	3407	3577

W	FILE/BOX, BOX (FB) & BOX, BOX/FILE (BF)			
	SOURCE LAMINATE		FLINTWOOD	VENEER
	Case, Back & Front	Case & Back, Flintwood Front	Case, Back & Front	Case, Back & Front
36 / 914	1996	2574	3535	3711
42 / 1066	2078	2680	3681	3865
48 / 1219	2164	2793	3834	4023

If Counterweight is specified, add 194

If Filing Accessory is specified, add:

Width 30"	108
Width 36"	
File/Box, Box	91
Hinged Door/Box, Box	122
Width 42"	
File/Box, Box	122
Hinged Door/Box, Box	112
Width 54"	
File/Box, Box	112
Hinged Door/Box, Box	143

# HTSCU

## Stage Shared Double Credenza

### WHAT'S INCLUDED

Case and drawers, feet, filing accessory (if box drawers are specified), hanging bar (when files drawer specified), false fronts, counterweights (if specified).

### NOTES

Backs include false front add-ons to match the front style and finish.

Counterweights are required in freestanding applications.

If Filing Accessory for box drawer is specified, the dividers match the color of the upStage handle, while the liner defaults to Ebony (Source Laminate) or Foundation Grey (Flintwood, Veneer front).

Configuration (B) Box/Box is not available if width 60" or 72" is specified.



Box, Box (B)

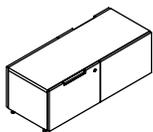

File (F)

### PRODUCT OPTIONS

Width	Configuration	Drawer Location	Pull Style	Pull Finish	Case, Front & Back Finish	Key	Counterweight	Filing Accessory
42, 48, 60, 72	F File	L Left	X upStage Handle	Foundation	Source Laminate	N No Key	1 Yes	Y Yes
	B Box, Box	R Right		Mica Accent	Flintwood Veneer	K Key Alike R Key Random	2 No	N No

### SAMPLE ORDER CODE

HTSCU 42	B	L	X	74	ZA	ZA	K	2	Y
----------	---	---	---	----	----	----	---	---	---

### DIMENSIONS INCHES / MM

W
42 / 1066
48 / 1219
60 / 1524
72 / 1829

### PRICING

FILE (F)				
SOURCE LAMINATE		FLINTWOOD	VENEER	
Case, Front & Back	Case, Flintwood Front & Back	Case, Front & Back	Case, Front & Back	
1781	2314	3206	3366	
1923	2500	3460	3631	
2078	2702	3736	3924	
2243	2918	4038	4235	

BOX, BOX (B)				
SOURCE LAMINATE		FLINTWOOD	VENEER	
Case, Front & Back	Case, Flintwood Front & Back	Case, Front & Back	Case, Front & Back	
2228	2896	4008	4208	
2405	3126	4324	4544	

If Counterweight is specified, add 194

If Filing Accessory is specified, add:

Width 42"	122
Width 48"	112





# HTSCZ

## Stage Triple Credenza

### WHAT'S INCLUDED

Case and drawers, levelers, filing accessory (if Box drawers are specified), hanging bar (when file drawers specified).

### NOTES

If Filing Accessory for box drawer is specified, the dividers match the color of the upStage handle, while the liner defaults to Ebony (Source Laminate) or Foundation Grey (Flintwood, Veneer front).

Hinged door includes Push Latch, no handle option is available.

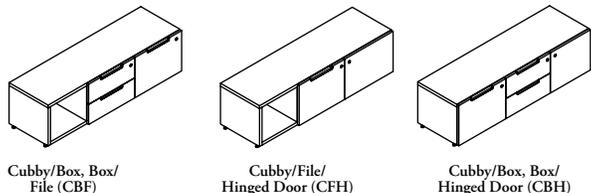

### PRODUCT OPTIONS

Width	Configuration	Pull Style	Pull Finish	Case & Back, Front Finish	Key	Filing Accessory
54, 60, 66, 72	<b>HFC</b> Hinged Door/File/Cubby	<b>X</b> upStage Handle	Foundation	Source Laminate	<b>N</b> No Key	<b>Y</b> Yes
	<b>CFH</b> Cubby/File/Hinged Door		Mica	Flintwood	<b>K</b> Key Alike	<b>N</b> No
	<b>HBC</b> Hinged Door/Box, Box/Cubby		Accent	Veneer	<b>R</b> Key Random	
	<b>CBH</b> Cubby/Box, Box/Hinged Door					
	<b>FBC</b> File/Box, Box/Cubby					
	<b>CBF</b> Cubby/Box, Box/File					
	<b>FBH</b> File/Box, Box/Hinged Door					
	<b>HBF</b> Hinged Door/Box, Box/File					

### SAMPLE ORDER CODE

<b>HTSCZ 66</b>	<b>CBH</b>	<b>X</b>	<b>74</b>	<b>ZA</b>	<b>ZA</b>	<b>K</b>	<b>N</b>
-----------------	------------	----------	-----------	-----------	-----------	----------	----------

### DIMENSIONS INCHES / MM

W
54 / 1372
60 / 1524
66 / 1676
72 / 1829

### PRICING

HINGED DOOR/FILE/CUBBY (HFC) & CUBBY/FILE/HINGED DOOR (CFH)				
SOURCE LAMINATE		FLINTWOOD		VENEER
Case, Back & Front	Case & Back, Flintwood Front	Case, Back & Front	Case, Back & Front	Case, Back & Front
1807	2387	3395		3565
1879	2480	3531		3708
1955	2581	3670		3856
2031	2680	3817		4008

HINGED DOOR/BOX, BOX/CUBBY (HBC) & CUBBY/BOX, BOX/HINGED DOOR (CBH)				
SOURCE LAMINATE		FLINTWOOD		VENEER
Case, Back & Front	Case & Back, Flintwood Front	Case, Back & Front	Case, Back & Front	Case, Back & Front
2008	2649	3774		3961
2087	2756	3924		4120
2172	2868	4080		4286
2258	2980	4243		4456

See Filing Accessory upcharge on the following page

Pricing is continued on the following page.

**HTSCZ**  
**Stage Triple Credenza (Continued)**

**DIMENSIONS**  
**INCHES / MM**

**PRICING**

W	<b>FILE/BOX, BOX/CUBBY (FBC) &amp; CUBBY/BOX, BOX/ FILE (CBF)</b>			
	<b>SOURCE LAMINATE</b>		<b>FLINTWOOD</b>	<b>VENEER</b>
	Case, Back & Front	Case & Back, Flintwood Front	Case, Back & Front	Case, Back & Front
54 / 1372	2270	3000	4269	4484
60 / 1524	2364	3119	4439	4664
66 / 1676	2460	3246	4618	4850
72 / 1829	2555	3374	4801	5042

W	<b>FILE/BOX, BOX/HINGED DOOR (FBH) &amp; HINGED DOOR/BOX, BOX/ FILE (HBF)</b>			
	<b>SOURCE LAMINATE</b>		<b>FLINTWOOD</b>	<b>VENEER</b>
	Case, Back & Front	Case & Back, Flintwood Front	Case, Back & Front	Case, Back & Front
54 / 1372	2380	3142	4473	4698
60 / 1524	2476	3268	4651	4884
66 / 1676	2576	3399	4838	5082
72 / 1829	2676	3536	5031	5281

If Filing Accessory is specified, add:

Width 54"	108
Width 60"	
File/Box, Box/Hinged Door & Hinged Door/Box, Box/Cubby	108
File/Box, Box/Cubby	122
Width 66"	
File/Box, Box/Hinged Door & Hinged Door/Box, Box/Cubby	108
File/Box, Box/Cubby	112
Width 72"	
File/Box, Box/Hinged Door & Hinged Door/Box, Box/Cubby	122
File/Box, Box/Cubby	112

# HTSCV

## Stage Shared Triple Credenza

### WHAT'S INCLUDED

Case and drawers, levelers, filing accessory (if Box drawers are specified), hanging bar (when file drawers specified).

### NOTES

If Filing Accessory for box drawer is specified, the dividers match the color of the upStage handle, while the liner defaults to Ebony (Source Laminate) or Foundation Grey (Flintwood, Veneer front).

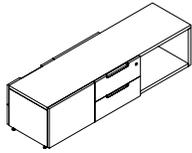

Box, Box (B)

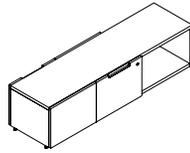

File (F)

### PRODUCT OPTIONS

Width	Configuration	Drawers Location	Pull Style	Pull Finish	Case, Front & Back Finish	Key	Filing Accessory
54, 60, 66, 72	<b>B</b> Box/Box <b>F</b> File	<b>L</b> Left <b>R</b> Right	<b>X</b> upStage Handle	Foundation Mica Accent	Source Laminate Flintwood Veneer	<b>N</b> No Key <b>K</b> Key Alike <b>R</b> Key Random	<b>Y</b> Yes <b>N</b> No

### SAMPLE ORDER CODE

<b>HTSCV 60</b>	<b>B</b>	<b>L</b>	<b>X</b>	<b>74</b>	<b>ZA</b>	<b>ZA</b>	<b>K</b>	<b>Y</b>
-----------------	----------	----------	----------	-----------	-----------	-----------	----------	----------

### DIMENSIONS INCHES / MM

W
54 / 1372
60 / 1524
66 / 1676
72 / 1829

### PRICING

#### BOX/BOX (B)

SOURCE LAMINATE		FLINTWOOD		VENEER	
Case, Front & Back	Case, Flintwood Front & Back	Case, Front & Back	Case, Front & Back	Case, Front & Back	Case, Front & Back
2630	3639	5230	5508	5508	5795
2773	3834	5508	5795	6095	6095
2926	4038	5795	5975	6285	6285
3021	4165	5975	5975	6285	6285

#### FILE (F)

SOURCE LAMINATE		FLINTWOOD		VENEER	
Case, Front & Back	Case, Flintwood Front & Back	Case, Front & Back	Case, Front & Back	Case, Front & Back	Case, Front & Back
2511	3478	5007	5270	5270	5545
2650	3666	5270	5545	5836	5836
2796	3860	5545	5720	6018	6018
2886	3984	5720	5720	6018	6018

If Filing Accessory is specified for Box/Box, add:

Width 54"	108
Width 60"	122
Width 66" & 72"	112



# HTSCY

## Elevated Double Credenza

### WHAT'S INCLUDED

Case and drawers, feet or casters (as specified), filing accessory (if box drawers are specified), hanging bar (when files drawer specified).

### WHAT'S EXCLUDED

Mobile Cubby Trays (HTAT), Cushion (HTAC).

### NOTES

The File/Box, Box (FB) and Box, Box/File (BF) configurations are only available in widths 36" - 48".

If Filing Accessory for box drawer is specified, the dividers match the color of the upStage handle, while the liner defaults to Ebony (Source Laminate) or Foundation Grey (Flintwood, Veneer front).

Hinged door includes Push Latch, no handle option is available.



Box, Box/Cubby (BC)

Box, Box/Hinged Door (BH)

File/Cubby (FC)

### PRODUCT OPTIONS

Width	Configuration	Base	Pull Style	Pull Finish
30, 36, 42, 48	<b>FC</b> File/Cubby	<b>C</b> Casters	<b>X</b> upStage Handle	Foundation Mica Accent
	<b>CF</b> Cubby/File	<b>F</b> Feet		
	<b>BC</b> Box, Box/Cubby			
	<b>CB</b> Cubby/Box, Box			
	<b>FH</b> File/Hinged Door			
	<b>HF</b> Hinged Door/File			
	<b>BH</b> Box, Box/Hinged Door			
	<b>HB</b> Hinged Door/Box, Box			
	<b>FB</b> File/Box, Box			
	<b>BF</b> Box, Box/File			

### SAMPLE ORDER CODE

<b>HTSCY 36</b>	<b>FC</b>	<b>C</b>	<b>X</b>	<b>74</b>
-----------------	-----------	----------	----------	-----------

### PRODUCT OPTIONS (CONTINUED)

Case & Back, Shelves & Front Finish	Foot Finish	Key	Filing Accessory
Source Laminate	<b>NN</b> Not Applicable (for Casters only)	<b>N</b> No Key	<b>Y</b> Yes <b>N</b> No
Flintwood	<b>74</b> Storm White	<b>K</b> Key Alike	
Veneer	<b>60</b> Platinum	<b>R</b> Key Random	
	<b>83</b> Very White		
	<b>68</b> Anthracite		
	<b>62</b> Graphite		
	<b>71</b> Burnished Bronze		

### SAMPLE ORDER CODE (CONTINUED)

<b>ZA</b>	<b>ZA</b>	<b>ZA</b>	<b>60</b>	<b>K</b>	<b>N</b>
-----------	-----------	-----------	-----------	----------	----------

See Pricing on the following page.

**HTSCY**  
**Elevated Double Credenza**  
**(Continued)**

**DIMENSIONS**  
**INCHES / MM**

**PRICING**

**FILE/CUBBY (FC) & CUBBY/FILE (CF)**

**WITH CASTERS (C)**

	SOURCE LAMINATE		FLINTWOOD	VENEER
W	Case,Back, Shelves & Front	Case, Back, Shelves & Flintwood Front	Case,Back Shelves & Front	Case,Back Shelves & Front
30 / 762	1808	2281	3312	3470
36 / 914	1858	2342	3410	3568
42 / 1066	1914	2413	3515	3681
48 / 1219	2141	2710	3958	4144

**WITH FEET (F)**

	SOURCE LAMINATE		FLINTWOOD	VENEER
W	Case,Back, Shelves & Front	Case, Back, Shelves & Flintwood Front	Case,Back Shelves & Front	Case,Back Shelves & Front
30 / 762	1968	2483	3622	3791
36 / 914	2019	2547	3717	3892
42 / 1066	2076	2618	3821	4006
48 / 1219	2124	2682	3920	4106

**BOX, BOX/CUBBY (BC) & CUBBY/BOX, BOX (CB)**

**WITH CASTERS (C)**

	SOURCE LAMINATE		FLINTWOOD	VENEER
W	Case,Back, Shelves & Front	Case, Back, Shelves & Flintwood Front	Case,Back Shelves & Front	Case,Back Shelves & Front
30 / 762	1800	2321	3474	3649
36 / 914	1854	2393	3580	3760
42 / 1066	1914	2469	3693	3879
48 / 1219	2067	2667	3991	4190

**WITH FEET (F)**

	SOURCE LAMINATE		FLINTWOOD	VENEER
W	Case,Back, Shelves & Front	Case, Back, Shelves & Flintwood Front	Case,Back Shelves & Front	Case,Back Shelves & Front
30 / 762	1960	2529	3782	3971
36 / 914	2016	2599	3890	4083
42 / 1066	2076	2674	4001	4202
48 / 1219	2132	2749	4112	4318

See Filing Accessory upcharge on the following page

Pricing is continued on the following page.

**H T S C Y**

**Elevated Double Credenza  
(Continued)**

**DIMENSIONS  
INCHES / MM**

**PRICING**

W	<b>FILE/HINGED DOOR (FH) &amp; HINGED DOOR/FILE (HF) WITH CASTERS (C)</b>			
	<b>SOURCE LAMINATE</b>		<b>FLINTWOOD</b>	<b>VENEER</b>
	Case,Back, Shelves & Front	Case, Back, Shelves & Flintwood Front	Case,Back Shelves & Front	Case,Back Shelves & Front
30 / 762	1941	2448	3566	3736
36 / 914	1990	2510	3661	3835
42 / 1066	2047	2584	3769	3948
48 / 1219	2182	2760	4035	4225

W	<b>WITH FEET (F)</b>			
	<b>SOURCE LAMINATE</b>		<b>FLINTWOOD</b>	<b>VENEER</b>
	Case,Back, Shelves & Front	Case, Back, Shelves & Flintwood Front	Case,Back Shelves & Front	Case,Back Shelves & Front
30 / 762	2101	2655	3877	4059
36 / 914	2149	2718	3968	4160
42 / 1066	2206	2788	4076	4269
48 / 1219	2255	2853	4173	4372

W	<b>BOX, BOX/HINGED DOOR (BH) &amp; HINGED DOOR/BOX, BOX (HB) WITH CASTERS (C)</b>			
	<b>SOURCE LAMINATE</b>		<b>FLINTWOOD</b>	<b>VENEER</b>
	Case,Back, Shelves & Front	Case, Back, Shelves & Flintwood Front	Case,Back Shelves & Front	Case,Back Shelves & Front
30 / 762	1930	2493	3728	3917
36 / 914	1988	2562	3835	4027
42 / 1066	2047	2639	3950	4144
48 / 1219	2200	2838	4246	4459

W	<b>WITH FEET (F)</b>			
	<b>SOURCE LAMINATE</b>		<b>FLINTWOOD</b>	<b>VENEER</b>
	Case,Back, Shelves & Front	Case, Back, Shelves & Flintwood Front	Case,Back Shelves & Front	Case,Back Shelves & Front
30 / 762	2089	2699	4038	4238
36 / 914	2147	2769	4141	4349
42 / 1066	2206	2845	4256	4469
48 / 1219	2261	2920	4369	4587

See Filing Accessory upcharge on the following page

Pricing is continued on the following page.



**HTSCY**  
**Elevated Double Credenza**  
**(Continued)**

**DIMENSIONS**  
**INCHES / MM**

**PRICING**

W	FILE/BOX, BOX (FB) & BOX, BOX/FILE (BF)			
	WITH CASTERS (C)			
	SOURCE LAMINATE	FLINTWOOD	VENEER	
	Case,Back, Shelves & Front	Case, Back, Shelves & Flintwood Front	Case,Back Shelves & Front	Case,Back Shelves & Front
36 / 914	2424	3072	4499	4714
42 / 1066	2441	3096	4536	4754
48 / 1219	2613	3312	4860	5095

W	WITH FEET (F)			
	SOURCE LAMINATE	FLINTWOOD	VENEER	
	Case,Back, Shelves & Front	Case, Back, Shelves & Flintwood Front	Case,Back Shelves & Front	Case,Back Shelves & Front
36 / 914	2553	3240	4753	4978
42 / 1066	2618	3321	4876	5108
48 / 1219	2681	3403	5001	5240

If Filing Accessory is specified, add:

Width 30"	108
Width 36"	
File/Box, Box	91
Box, Box/Cubby &	
Box, Box/Hinged Door	122
Width 42"	
File/Box, Box	122
Box, Box/Cubby &	
Box, Box/Hinged Door	112
Width 48"	
File/Box, Box	112
Box, Box/Cubby &	
Box, Box/Hinged Door	143

**HTSCX**

**Elevated Triple Credenza**

**WHAT'S INCLUDED**

Case with drawers, feet, filing accessory (if box drawers are specified), hanging bar (when files drawer specified).

**WHAT'S EXCLUDED**

Mobile Cubby Trays (HTAT), Cushion (HTAC).

**NOTES**

If Filing Accessory for box drawer is specified, the dividers match the color of the upStage handle, while the liner defaults to Ebony (Source Laminate) or Foundation Grey (Flintwood, Veneer front).

Hinged door includes Push Latch, no handle option is available.



**PRODUCT OPTIONS**

Width	Configuration	Pull Style	Pull Finish	Case & Back, Shelves & Front Finish	Foot Finish	Key	Filing Accessory
54, 60, 66, 72	<b>HFC</b> Hinged Door/File/ Cubby	<b>X</b> upStage Handle	Foundation Mica Accent	Source Laminate Flintwood Veneer	74 Storm White 60 Platinum 83 Very White 68 Anthracite 62 Graphite 71 Burnished Bronze	<b>N</b> No Key <b>K</b> Key Alike <b>R</b> Key Random	<b>Y</b> Yes <b>N</b> No
	<b>CFH</b> Cubby/File/Hinged Door						
	<b>HBC</b> Hinged Door/Box, Box/Cubby						
	<b>CBH</b> Cubby/Box, Box/Hinged Door						
	<b>FBC</b> File/Box, Box/Cubby						
	<b>CBF</b> Cubby/Box, Box/File						
	<b>FBH</b> File/Box, Box/Hinged Door						
	<b>HBF</b> Hinged Door/Box, Box/File						

**SAMPLE ORDER CODE**

<b>HTSCX 60</b>	<b>HFC</b>	<b>X</b>	<b>74</b>	<b>ZA</b>	<b>ZA</b>	<b>ZA</b>	<b>60</b>	<b>K</b>	<b>N</b>
-----------------	------------	----------	-----------	-----------	-----------	-----------	-----------	----------	----------

**DIMENSIONS  
INCHES / MM**

W
54 / 1372
60 / 1524
66 / 1676
72 / 1829

**PRICING**

**HINGED DOOR/FILE/CUBBY (HFC) & CUBBY/FILE/HINGED DOOR (CFH)**

SOURCE LAMINATE		FLINTWOOD		VENEER	
Case,Back, Shelves & Front	Case, Back, Shelves & Flintwood Front	Case,Back Shelves & Front	Case,Back Shelves & Front	Case,Back Shelves & Front	Case,Back Shelves & Front
2253	2971	4834	5079	5079	5333
2364	3119	5079	5333	5599	5599
2481	3274	5333	5632	5632	5632
2495	3294	5363			

**HINGED DOOR/BOX, BOX/CUBBY (HBC) & CUBBY/BOX, BOX/HINGED DOOR (CBH)**

SOURCE LAMINATE		FLINTWOOD		VENEER	
Case,Back, Shelves & Front	Case, Back, Shelves & Flintwood Front	Case,Back Shelves & Front	Case,Back Shelves & Front	Case,Back Shelves & Front	Case,Back Shelves & Front
2470	3260	5308	5573	5573	5853
2592	3425	5573	5853	6145	6145
2722	3595	5853	6190	6190	6190
2744	3623	5897			

See Filing Accessory upcharge on the following page

Pricing is continued on the following page.

**H T S C X**  
**Elevated Triple Credenza**  
**(Continued)**

**DIMENSIONS**  
**INCHES / MM**

**PRICING**

**FILE/BOX, BOX/CUBBY (FBC) & CUBBY/BOX, BOX/FILE (CBF)**

	SOURCE LAMINATE		FLINTWOOD	VENEER
W	Case,Back, Shelves & Front	Case, Back, Shelves & Flintwood Front	Case,Back Shelves & Front	Case,Back Shelves & Front
54 / 1372	2760	3643	5933	6229
60 / 1524	2898	3828	6229	6541
66 / 1676	3042	4015	6541	6867
72 / 1829	2936	3878	6311	6629

**FILE/BOX, BOX/HINGED DOOR (FBH) & HINGED DOOR/BOX, BOX/FILE (HBF)**

	SOURCE LAMINATE		FLINTWOOD	VENEER
	Case,Back, Shelves & Front	Case, Back, Shelves & Flintwood Front	Case,Back Shelves & Front	Case,Back Shelves & Front
54 / 1372	2878	3800	6185	6495
60 / 1524	3022	3988	6495	6819
66 / 1676	3174	4188	6819	7162
72 / 1829	2786	3677	5988	6287

If Filing Accessory is specified, add:

Width 54"	108
Width 60"	
File/Box, Box/Hinged Door & Hinged Door/Box, Box/Cubby	108
File/Box, Box/Cubby	122
Width 66"	
File/Box, Box/Hinged Door & Hinged Door/Box, Box/Cubby	108
File/Box, Box/Cubby	112
Width 72"	
File/Box, Box/Hinged Door	122
File/Box, Box/Cubby & Hinged Door/Box, Box/Cubby	112

# HTSCR

## Elevated Shared Double Credenza



Box, Box (B)

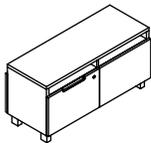

File (F)

### WHAT'S INCLUDED

Case and drawers, filing accessory (if box drawers are specified), hanging bar (when files drawer specified), false fronts, counterweights (if specified).

### WHAT'S EXCLUDED

Mobile Cubby Trays (HTAT), Cushion (HTAC).

### NOTES

Backs include false front add-ons to match the front style and finish.

Counterweights are required in freestanding applications.

If Filing Accessory for box drawer is specified, the dividers match the color of the upStage handle, while the liner defaults to Ebony (Source Laminate) or Foundation Grey (Flintwood, Veneer front).

The cubby space for trays are open through (no backs), are accessible from both sides.

### PRODUCT OPTIONS

Width	Configuration	Drawer Location	Pull Style	Pull Finish
42, 48	<b>B</b> Box/Box <b>F</b> File	<b>L</b> Left <b>R</b> Right	<b>X</b> upStage Handle	Foundation Mica Accent

### SAMPLE ORDER CODE

<b>HTSCR 48</b>	<b>B</b>	<b>R</b>	<b>X</b>	<b>74</b>
-----------------	----------	----------	----------	-----------

### PRODUCT OPTIONS (CONTINUED)

Case, Shelves, Front & Back Finish	Foot Finish	Key	Counterweight	Filing Accessory
Source Laminate	<b>74</b> Storm White	<b>N</b> No Key	<b>1</b> Yes	<b>Y</b> Yes
Flintwood	<b>60</b> Platinum	<b>K</b> Key Alike	<b>2</b> No	<b>N</b> No
Veneer	<b>83</b> Very White	<b>R</b> Key Random		
	<b>68</b> Anthracite			
	<b>62</b> Graphite			
	<b>71</b> Burnished Bronze			

### SAMPLE ORDER CODE (CONTINUED)

<b>ZA</b>	<b>ZA</b>	<b>ZA</b>	<b>60</b>	<b>K</b>	<b>2</b>	<b>Y</b>
-----------	-----------	-----------	-----------	----------	----------	----------

See Pricing on the following page.

**H T S C R**  
**Elevated Shared Double Credenza**  
**(Continued)**

**DIMENSIONS**  
**INCHES / MM**

**PRICING**

	<b>FILE (F)</b>			
	<b>SOURCE LAMINATE</b>		<b>FLINTWOOD</b>	<b>VENEER</b>
W	Case, Shelves, Front & Back	Case, Shelves & Flintwood Front & Back	Case, Shelves, Front & Back	Case, Shelves, Front & Back
42 / 1066	2282	2963	4476	4704
48 / 1219	2344	3048	4604	4833

	<b>BOX, BOX (B)</b>			
	<b>SOURCE LAMINATE</b>		<b>FLINTWOOD</b>	<b>VENEER</b>
	Case, Shelves, Front & Back	Case, Shelves & Flintwood Front & Back	Case, Shelves, Front & Back	Case, Shelves, Front & Back
42 / 1066	2667	3468	5240	5500
48 / 1219	2739	3561	5377	5647

If Counterweight is specified, add 194

If Filing Accessory is specified, add:

Width 42"	122
Width 48"	112

# HTSCQ

## Elevated Shared Triple Credenza

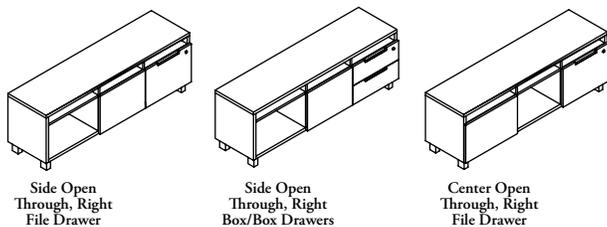

### WHAT'S INCLUDED

Case and drawers, filing accessory (if box drawers are specified), hanging bar (when files drawer specified), false fronts, fifth foot.

### WHAT'S EXCLUDED

Mobile Cubby Trays (HTAT), Cushion (HTAC).

### NOTES

If Filing Accessory for box drawer is specified, the dividers match the color of the upStage handle, while the liner defaults to Ebony (Source Laminate) or Foundation Grey (Flintwood, Veneer front).

The cubby space for trays and Open Cubbies are open through (no backs) and are accessible from both sides.

Backs include false front add-ons to match the front style and finish.

### PRODUCT OPTIONS

Width	Open Through Location	Drawer Location	Configuration	Pull Style
54, 60, 66, 72	<b>S</b> Side <b>C</b> Center	<b>L</b> Left <b>R</b> Right	<b>F</b> File <b>B</b> Box/Box	<b>X</b> upStage Handle

### SAMPLE ORDER CODE

<b>HTSCQ 60</b>	<b>C</b>	<b>L</b>	<b>B</b>	<b>X</b>
-----------------	----------	----------	----------	----------

### PRODUCT OPTIONS (CONTINUED)

Pull Finish	Case, Shelves, Front & Back Finish	Foot Finish	Key	Filing Accessory
Foundation	Source Laminate	<b>74</b> Storm White	<b>N</b> No Key	<b>Y</b> Yes
Mica	Flintwood	<b>60</b> Platinum	<b>K</b> Key Alike	<b>N</b> No
Accent	Veneer	<b>83</b> Very White	<b>R</b> Key Random	
		<b>68</b> Anthracite		
		<b>62</b> Graphite		
		<b>71</b> Burnished Bronze		

### SAMPLE ORDER CODE (CONTINUED)

<b>74</b>	<b>ZA</b>	<b>ZA</b>	<b>ZA</b>	<b>60</b>	<b>K</b>	<b>Y</b>
-----------	-----------	-----------	-----------	-----------	----------	----------

See Pricing on the following page.

**HTSCQ**  
**Elevated Shared Triple Credenza**  
**(Continued)**

**DIMENSIONS**  
**INCHES / MM**

**PRICING**

W	FILE (F)			
	SOURCE LAMINATE	FLINTWOOD	VENEER	
	Case, Shelves, Front & Back	Case, Shelves & Flintwood Front & Back	Case, Shelves, Front & Back	Case, Shelves, Front & Back
54 / 1372	3036	4099	5779	6066
60 / 1524	3188	4302	6066	6370
66 / 1676	3347	4520	6370	6690
72 / 1829	3445	4653	6563	6892

  

W	BOX, BOX (B)			
	SOURCE LAMINATE	FLINTWOOD	VENEER	
	Case, Shelves, Front & Back	Case, Shelves & Flintwood Front & Back	Case, Shelves, Front & Back	Case, Shelves, Front & Back
54 / 1372	3166	4275	6027	6329
60 / 1524	3324	4488	6329	6644
66 / 1676	3490	4711	6644	6977
72 / 1829	3595	4853	6843	7186

If Filing Accessory is specified, add:

Width 54"	108
Width 60"	
Box, Box/Open through Side Cubby	108
Box, Box/Open through Center Cubby	122
Width 66"	122
Width 72"	
Box, Box/Open through Side Cubby	122
Box, Box/Open through Center Cubby	112

## HTSL Lockers

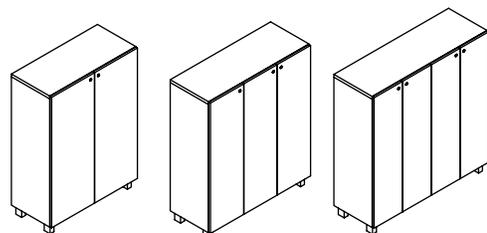

Dual, Push Latch

Triple, Push Latch

Quad, Push Latch

### WHAT'S INCLUDED

1 case, doors, four feet, locks and keys (if specified), handles (if specified)  
Per locker compartment :  
- 1 adjustable shelf  
- 1 corner shelf with coat hook (51" high+).

### NOTES

The Dual (D) configuration is only available in widths 30" - 36".

The Triple (T) configuration is only available in widths 42" - 48".

The Quad (Q) configuration is only available in width 48".

Door Swing directions Left (L) or Right (R) must be specified if the Triple (T) configuration is selected.

Push Latch (P) pull style is only available in heights 42" and 51".

### PRODUCT OPTIONS

Configuration	Height	Width	Door Swing Direction	Pull Style
D Dual T Triple Q Quad	42, 51, 66	30, 36, 42, 48	N Not Application L Left R Right	P Push Latch X upStage Handle

### SAMPLE ORDER CODE

<b>HTSL D</b>	<b>51</b>	<b>36</b>	<b>N</b>	<b>P</b>
---------------	-----------	-----------	----------	----------

### PRODUCT OPTIONS (CONTINUED)

Pull Finish	Case & Back, Front Finish	Foot Finish	Key
NN Not Applicable (for Push Latch only) Foundation Mica Accent	Source Laminate Flintwood Veneer	74 Storm White 60 Platinum 83 Very White 68 Anthracite 62 Graphite 71 Burnished Bronze	N No Key K Key Alike R Key Random

### SAMPLE ORDER CODE (CONTINUED)

<b>NN</b>	<b>ZA</b>	<b>ZA</b>	<b>60</b>	<b>K</b>
-----------	-----------	-----------	-----------	----------

See Pricing on the following page.



## HTSL Lockers (Continued)

**DIMENSIONS  
INCHES / MM**

H	W
42 / 1066	30 / 762
42 / 1066	36 / 914
51 / 1295	30 / 762
51 / 1295	36 / 914

42 / 1066	30 / 762
42 / 1066	36 / 914
51 / 1295	30 / 762
51 / 1295	36 / 914
66 / 1676	30 / 762
66 / 1676	36 / 914

H	W
42 / 1066	42 / 1066
42 / 1066	48 / 1067
51 / 1295	42 / 1066
51 / 1295	48 / 1067

42 / 1066	42 / 1066
42 / 1066	48 / 1067
51 / 1295	42 / 1066
51 / 1295	48 / 1067
66 / 1676	42 / 1066
66 / 1676	48 / 1067

H	W
42 / 1066	48 / 1067
51 / 1295	48 / 1067

42 / 1066	48 / 1067
51 / 1295	48 / 1067
66 / 1676	48 / 1067

**PRICING**

<b>DUAL (D)</b>			
<b>PUSH LATCH (P)</b>			
SOURCE LAMINATE		FLINTWOOD	VENEER
Case, Back & Front	Case & Back, Flintwood Front	Case, Back & Front	Case, Back & Front
2854	3769	4759	4996
3068	4052	5115	5370
2999	3957	4996	5244
3222	4255	5370	5640

<b>UPSTAGE HANDLE (X)</b>			
SOURCE LAMINATE		FLINTWOOD	VENEER
Case, Back & Front	Case & Back, Flintwood Front	Case, Back & Front	Case, Back & Front
2928	3865	4879	5122
3142	4145	5237	5497
3074	4058	5122	5377
3299	4354	5497	5771
3300	4355	5499	5776
3466	4575	5776	6063

<b>TRIPLE (Q)</b>			
<b>PUSH LATCH (P)</b>			
SOURCE LAMINATE		FLINTWOOD	VENEER
Case, Back & Front	Case & Back, Flintwood Front	Case, Back & Front	Case, Back & Front
3641	4804	6065	6367
3821	5045	6367	6688
3821	5045	6367	6688
4014	5298	6688	7022

<b>UPSTAGE HANDLE (X)</b>			
SOURCE LAMINATE		FLINTWOOD	VENEER
Case, Back & Front	Case & Back, Flintwood Front	Case, Back & Front	Case, Back & Front
3750	4948	6246	6558
3937	5195	6558	6885
3937	5195	6558	6885
4134	5456	6885	7230
4254	5614	7086	7440
4254	5614	7086	7440

<b>QUAD (Q)</b>			
<b>PUSH LATCH (P)</b>			
SOURCE LAMINATE		FLINTWOOD	VENEER
Case, Back & Front	Case & Back, Flintwood Front	Case, Back & Front	Case, Back & Front
4463	5889	7435	7806
4684	6184	7806	8196

<b>UPSTAGE HANDLE (X)</b>			
SOURCE LAMINATE		FLINTWOOD	VENEER
Case, Back & Front	Case & Back, Flintwood Front	Case, Back & Front	Case, Back & Front
4607	6083	7677	8060
4837	6388	8060	8462
5090	6719	8479	8903

## HTSLC Cubby Lockers

### WHAT'S INCLUDED

1 case, doors, 4 feet, locks and keys (if specified), handles (if specified).

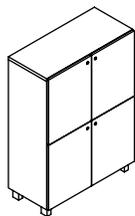

Hinged Door,  
Push Latch



Hinged Door with  
Mail Slots, Push Latch

### PRODUCT OPTIONS

Height	Width	Configuration	Pull Style	Pull Finish	Case & Back, & Front Finish	Foot Finish	Key
51, 66	30, 36, 42	<b>G</b> Hinged Doors <b>M</b> Hinged Doors with Mail Slots	<b>P</b> Push Latch <b>X</b> upStage Handle	<b>NN</b> Not Applicable (for Push Latch only) Foundation Mica Accent	Source Laminate Flintwood Veneer	<b>74</b> Storm White <b>60</b> Platinum <b>83</b> Very White <b>68</b> Anthracite <b>62</b> Graphite <b>71</b> Burnished Bronze	<b>N</b> No Key <b>K</b> Key Alike <b>R</b> Key Random

### SAMPLE ORDER CODE

<b>HTSLC 51</b>	<b>36</b>	<b>G</b>	<b>X</b>	<b>74</b>	<b>ZA</b>	<b>ZA</b>	<b>60</b>	<b>K</b>
-----------------	-----------	----------	----------	-----------	-----------	-----------	-----------	----------

### DIMENSIONS INCHES / MM

H	W
51 / 1295	30 / 762
51 / 1295	36 / 914
51 / 1295	42 / 1066
66 / 1676	30 / 762
66 / 1676	36 / 914
66 / 1676	42 / 1066

### PRICING

#### HINGED DOORS (G), PUSH LATCH (P)

SOURCE LAMINATE		FLINTWOOD		VENEER	
Case, Back & Front	Case & Back, Flintwood Front	Case, Back & Front	Case, Back & Front	Case, Back & Front	Case, Back & Front
3546	4681	5471	5748	5748	5748
3809	5029	5877	6171	6171	6171
4087	5396	6305	6622	6622	6622
3736	4934	5764	6054	6054	6054
4013	5298	6187	6500	6500	6500
4307	5682	6641	6973	6973	6973

#### HINGED DOORS (G), UPSTAGE HANDLE (X)

SOURCE LAMINATE		FLINTWOOD		VENEER	
Case, Back & Front	Case & Back, Flintwood Front	Case, Back & Front	Case, Back & Front	Case, Back & Front	Case, Back & Front
3684	4861	5684	5969	5969	5969
3948	5212	6090	6394	6394	6394
4227	5579	6519	6845	6845	6845
3877	5116	5978	6276	6276	6276
4150	5478	6401	6722	6722	6722
4442	5863	6854	7196	7196	7196

Pricing is continued on the following page

**HTSLC**  
**Cubby Lockers (Continued)**

**DIMENSIONS**  
**INCHES / MM**

H	W
51 / 1295	30 / 762
51 / 1295	36 / 914
51 / 1295	42 / 1066
66 / 1676	30 / 762
66 / 1676	36 / 914
66 / 1676	42 / 1066

**PRICING**

**HINGED DOORS WITH MAIL SLOTS (M), PUSH LATCH (P)**

SOURCE LAMINATE		FLINTWOOD	VENEER
Case, Back & Front	Case & Back, Flintwood Front	Case, Back & Front	Case, Back & Front
3641	4806	5617	5898
3901	5152	6020	6321
4185	5520	6451	6774
3833	5059	5911	6208
4106	5422	6336	6653
4400	5809	6787	7127

**HINGED DOORS WITH MAIL SLOTS (M), UPSTAGE HANDLE (X)**

SOURCE LAMINATE		FLINTWOOD	VENEER
Case, Back & Front	Case & Back, Flintwood Front	Case, Back & Front	Case, Back & Front
3779	4988	5830	6122
4043	5335	6235	6546
4319	5704	6665	6998
3970	5240	6124	6428
4246	5603	6548	6877
4540	5991	7003	7351

## HTSM Mobile Pedestal

### WHAT'S INCLUDED

Case and drawers/door, casters.

### WHAT'S EXCLUDED

Mobile Cubby Trays (HTAT).

### NOTES

upStage handle is not available on hinged doors, must be specified with Push Latch (P).

Push Latch (P) is not available on file drawer, must be specified with upStage Handle (X).

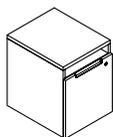

File Drawer

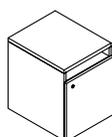

Hinged Door

### PRODUCT OPTIONS

Style	Pull Style	Pull Finish	Case & Back, Shelf & Front Finish	Key	Seat Cushion	Seat Cushion Finish
<b>HL</b> Hinged Door Left Swing	<b>P</b> Push Latch	<b>NN</b> Not Applicable (for Push Latch only) Foundation Mica Accent	Source Laminate	<b>N</b> No Key	<b>Y</b> Yes	Fabric
<b>HR</b> Hinged Door Right Swing	<b>X</b> upStage Handle		Flintwood	<b>K</b> Key Alike	<b>N</b> No	
<b>FN</b> File Drawer			Veneer	<b>R</b> Key Random		

### SAMPLE ORDER CODE

<b>HTSM HL</b>	<b>X</b>	<b>74</b>	<b>ZA</b>	<b>ZA</b>	<b>ZA</b>	<b>K</b>	<b>Y</b>	<b>F510</b>
----------------	----------	-----------	-----------	-----------	-----------	----------	----------	-------------

### PRICING

#### HINGED DOOR (HR, HL), PUSH LATCH (P)

SOURCE LAMINATE		FLINTWOOD	VENEER
Case, Back, Shelves & Front	Case, Back, Shelves & Flintwood Front	Case, Back, Shelves & Front	Case, Back, Shelves & Front
793	1167	1637	1720

#### FILE DRAWER (FN), UPSTAGE HANDLE (X)

SOURCE LAMINATE		FLINTWOOD	VENEER
Case, Back, Shelves & Front	Case, Back, Shelves & Flintwood Front	Case, Back, Shelves & Front	Case, Back, Shelves & Front
1053	1547	2172	2282

#### IF SEAT IS SPECIFIED ADD THE FOLLOWING:

Gr. 1	COM/Gr. 2	COL/Gr. 3	Gr. 4	Gr. 5	Gr. 6	Gr. 7	Gr. 8	Gr. 9	Gr. 10	Leather LA	Leather LB	Leather LC	Leather LD
625	688	714	746	762	778	811	843	875	907	1093	1165	1369	1434



**HTST**  
**Lateral Tower**

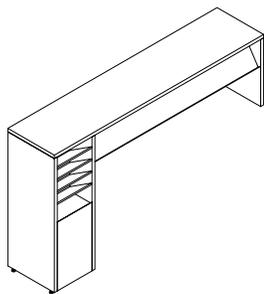

**WHAT'S INCLUDED**

1 Lateral Tower unit with hardware, lock and keys (if specified).

**NOTES**

Double Sided configuration (D) is non-handed; handedness applies only when Single Sided configurations (S) is selected.

Ships disassembled.

**PRODUCT OPTIONS**

Height	Depth	Width	Style	Configuration
42	16	60, 66, 72	G Gable S Storage	S Single Sided D Double Sided

**SAMPLE ORDER CODE**

<b>HTST 42</b>	<b>16</b>	<b>60</b>	<b>G</b>	<b>D</b>
----------------	-----------	-----------	----------	----------

**PRODUCT OPTIONS (CONTINUED)**

Handedness	Mount	Case & Secondary Finish	Metal Paint Finish	Key
N Not Applicable L Left R Right	S Stage C Credenza	Source Laminate Flintwood Veneer	Foundation Mica Accent	N No Key K Key Alike R Key Random

**SAMPLE ORDER CODE (CONTINUED)**

<b>N</b>	<b>S</b>	<b>ZA</b>	<b>ZA</b>	<b>74</b>	<b>K</b>
----------	----------	-----------	-----------	-----------	----------

See Pricing on the following page.

**H T S T**  
**Lateral Tower**  
**(Continued)**

**DIMENSIONS**  
**INCHES / MM**

H	D	W
42 / 1219	16 / 406	60 / 1524
42 / 1219	16 / 406	66 / 1676
42 / 1219	16 / 406	72 / 1829

42 / 1219	16 / 406	60 / 1524
42 / 1219	16 / 406	66 / 1676
42 / 1219	16 / 406	72 / 1829

H	D	W
42 / 1219	16 / 406	60 / 1524
42 / 1219	16 / 406	66 / 1676
42 / 1219	16 / 406	72 / 1829

42 / 1219	16 / 406	60 / 1524
42 / 1219	16 / 406	66 / 1676
42 / 1219	16 / 406	72 / 1829

**PRICING**

**GABLE (G)**

**SINGLE SIDED, LEFT/RIGHT (S)**

Source Laminate	Flintwood	Veneer
1272	1787	1876
1320	1839	1929
1370	1888	1982

**DOUBLE SIDED (D)**

Source Laminate	Flintwood	Veneer
1308	1668	1750
1378	1728	1816
1447	1791	1881

**STORAGE (S)**

**SINGLE SIDED, LEFT/RIGHT (S)**

Source Laminate	Flintwood	Veneer
2049	3136	3294
2078	3187	3346
2106	3236	3398

**DOUBLE SIDED (D)**

Source Laminate	Flintwood	Veneer
2685	3767	3953
2720	3847	4040
2755	3927	4127

If Mica/Accent is specified, add 52

## HTSFT Side Filer

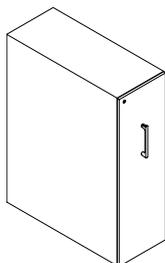

The Side Filer offers personal storage with space dividing functionality (users can leave the side filer open for lateral privacy). Designed for fixed or height-adjustable tables, it can be freestanding or attached based on layout requirements. Accessories can be specified for further functionality and better organization.

### WHAT'S INCLUDED

1 Side Filer unit with levelers, 1 drawer with casters, metal shelves, 1 coat hook (wardrobe option only), lock and keys, USB with extension kit, grommet (if specified).

If Accessory Bundle A is specified: 1 pen pocket, one hanging tray, 1 headphone hook

If Accessory Bundle B is specified: 1 pen pocket, 1 hanging tray, 1 headphone hook, 1 Paper Filer

### WHAT'S EXCLUDED

Storage to Worksurface Support Kit (HTWS).

The Digital Lock (D) option does not include the Programming Key and the separate Manager Key. For further details on both related keys, see the *Teknion Lock Specification Guide* on our website.

### NOTES

Configurations without Wardrobe: (K), (M), & (P) are only available in Depth 24".

Each USB Outlet has one USB-A port and one USB-C port for charging only.

The USB-A port supplies 18 Watts maximum at 5 Volts DC when used alone.

The USB-C port supplies 20 Watts maximum at 5 to 12 Volts DC when used alone.

Maximum combined output is 20 Watts when both ports are used together : 10 Watts for USB-A port & 10 Watts for USB-B

### PRODUCT OPTIONS

Height	Depth	Configuration	Handedness
42, 51	24, 30, 32, 38	<b>K</b> No Accessories, No Wardrobe <b>N</b> No Accessories, with Wardrobe <b>M</b> Accessory Bundle A, No Wardrobe <b>A</b> Accessory Bundle A, with Wardrobe <b>P</b> Accessory Bundle B, No Wardrobe <b>B</b> Accessory Bundle B, with Wardrobe	<b>L</b> Left <b>R</b> Right

### SAMPLE ORDER CODE

<b>HTSFT 42</b>	<b>30</b>	<b>N</b>	<b>L</b>
-----------------	-----------	----------	----------

### PRODUCT OPTIONS (CONTINUED)

Pull Finish	Case & Front Finish	Metal Finish	USB Power	Key
Foundation	Source Laminate	Foundation	<b>N</b> No	<b>N</b> No Key
Mica	Flintwood	Mica	<b>S</b> Grommet on the side	<b>K</b> Key Alike
Accent	Veneer	Accent	<b>B</b> Grommet at the base	<b>R</b> Key Random
				<b>D</b> Digital Lock

### SAMPLE ORDER CODE (CONTINUED)

<b>74</b>	<b>ZA</b>	<b>ZA</b>	<b>74</b>	<b>N</b>	<b>N</b>
-----------	-----------	-----------	-----------	----------	----------

See Pricing on the following page.



**H T S F T**  
**Side Filer (Continued)**

**DIMENSIONS  
INCHES / MM**

**PRICING**

**NO ACCESSORIES, NO WARDROBE (K)**

DIMENSIONS		SOURCE LAMINATE			FLINTWOOD	VENEER
H	D	Case & Front	Case & Flintwood Front	Case & Veneer Front	Case & Front	Case & Front
42 / 1219	24 / 610	2741	2869	2939	4784	5021
51 / 1295	24 / 610	2953	3094	3172	5079	5334

**NO ACCESSORIES, WITH WARDROBE (N)**

DIMENSIONS		SOURCE LAMINATE			FLINTWOOD	VENEER
H	D	Case & Front	Case & Flintwood Front	Case & Veneer Front	Case & Front	Case & Front
42 / 1219	24 / 610	2847	2975	3049	5015	5268
42 / 1219	30 / 762	3179	3201	3281	5340	5606
42 / 1219	32 / 813	3278	3354	3436	5425	5697
42 / 1219	38 / 965	3376	3504	3593	5512	5785
51 / 1295	24 / 610	3059	3201	3281	5340	5606
51 / 1295	30 / 762	3390	3534	3622	5745	6031
51 / 1295	32 / 813	3487	3630	3721	5919	6216
51 / 1295	38 / 965	3580	3729	3825	5942	6238

**ACCESSORIES BUNDLE A, NO WARDROBE (M)**

DIMENSIONS		SOURCE LAMINATE			FLINTWOOD	VENEER
H	D	Case & Front	Case & Flintwood Front	Case & Veneer Front	Case & Front	Case & Front
42 / 1219	24 / 610	2898	3023	3096	4939	5179
51 / 1295	24 / 610	3109	3249	3328	5237	5489

**ACCESSORIES BUNDLE A, WITH WARDROBE (A)**

DIMENSIONS		SOURCE LAMINATE			FLINTWOOD	VENEER
H	D	Case & Front	Case & Flintwood Front	Case & Veneer Front	Case & Front	Case & Front
42 / 1219	24 / 610	3004	3131	3204	5170	5423
42 / 1219	30 / 762	3335	3357	3436	5496	5763
42 / 1219	32 / 813	3434	3509	3593	5582	5853
42 / 1219	38 / 965	3534	3659	3747	5666	5942
51 / 1295	24 / 610	3215	3357	3436	5496	5763
51 / 1295	30 / 762	3546	3688	3776	5899	6185
51 / 1295	32 / 813	3643	3786	3878	6076	6372
51 / 1295	38 / 965	3737	3887	3979	6096	6394

If Mica/Accent is specified, add 52  
 If USB is specified, add 319  
 If Digital Lock is specified, add 579

Pricing is continued on the following page

**H T S F T**

**Side Filer (Continued)**

**DIMENSIONS  
INCHES / MM**

**PRICING**

H		D		ACCESSORIES BUNDLE B, NO WARDROBE (P)				
				SOURCE LAMINATE			FLINTWOOD	VENEER
		Case & Front	Case & Flintwood Front	Case & Veneer Front	Case & Front	Case & Front		
42 / 1219	24 / 610	2996	3124	3194	5037	5275		
51 / 1295	24 / 610	3207	3350	3426	5334	5589		

H		D		ACCESSORIES BUNDLE B, WITH WARDROBE (B)				
				SOURCE LAMINATE			FLINTWOOD	VENEER
		Case & Front	Case & Flintwood Front	Case & Veneer Front	Case & Front	Case & Front		
42 / 1219	24 / 610	3101	3229	3305	5271	5522		
42 / 1219	30 / 762	3434	3455	3536	5596	5861		
42 / 1219	32 / 813	3534	3606	3691	5679	5950		
42 / 1219	38 / 965	3630	3758	3846	5764	6040		
51 / 1295	24 / 610	3312	3455	3536	5596	5861		
51 / 1295	30 / 762	3646	3786	3877	5998	6285		
51 / 1295	32 / 813	3742	3887	3977	6175	6471		
51 / 1295	38 / 965	3835	3985	4077	6195	6493		

If Mica/Accent is specified, add 52

If USB is specified, add 319

If Digital Lock is specified, add 579



# HTSFS

## Mini Side Filer

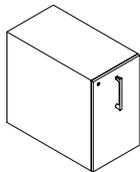

The Mini Side Filer offers personal storage and space division and is designed to be worksurface supporting.

### WHAT'S INCLUDED

1 Mini Side Filer unit with levelers, 1 drawer, metal shelves, lock and keys, USB with extension kit, grommet (if specified).

### WHAT'S EXCLUDED

Storage to Worksurface Support Kit (HTWS).

The Digital Lock (D) option does not include the Programming Key and the separate Manager Key. For further details on both related keys, see the *Teknion Lock Specification Guide* on our website.

### NOTES

Each USB Outlet has one USB-A port and one USB-C port for charging only.

The USB-A port supplies 18 Watts maximum at 5 Volts DC when used alone.

The USB-C port supplies 20 Watts maximum at 5 to 12 Volts DC when used alone.

Maximum combined output is 20 Watts when both ports are used together : 10 Watts for USB-A port & 10 Watts for USB-B

### PRODUCT OPTIONS

Height	Depth	Configuration	Handedness
28	23, 29	<b>N</b> No Accessories <b>A</b> Accessory Bundle A <b>B</b> Accessory Bundle B	<b>L</b> Left <b>R</b> Right

### SAMPLE ORDER CODE

<b>HTSFS 28</b>	<b>23</b>	<b>N</b>	<b>L</b>
-----------------	-----------	----------	----------

### PRODUCT OPTIONS (CONTINUED)

Pull Finish	Case & Front Finish	Metal Finish	USB Power	Key
Foundation	Source Laminate	Foundation	<b>N</b> No	<b>N</b> No Key
Mica	Flintwood	Mica	<b>Y</b> Yes	<b>K</b> Key Alike
Accent	Veneer	Accent		<b>R</b> Key Random
				<b>D</b> Digital Lock

### SAMPLE ORDER CODE (CONTINUED)

<b>74</b>	<b>ZA</b>	<b>ZA</b>	<b>74</b>	<b>N</b>	<b>N</b>
-----------	-----------	-----------	-----------	----------	----------

See Pricing on the following page.

**H T S F S**  
**Mini Side Filer (Continued)**

**DIMENSIONS**  
**INCHES / MM**

H	D
28 / 711	23 / 584
28 / 711	29 / 737

**PRICING**

**NO ACCESSORIES (N)**

SOURCE LAMINATE			FLINTWOOD	VENEER
Case & Front	Case & Flintwood Front	Case & Veneer Front	Case & Front	Case & Front
2403	2498	2560	4443	4667
2826	2922	2996	4706	4941

**ACCESSORY BUNDLE A (A)**

SOURCE LAMINATE			FLINTWOOD	VENEER
Case & Front	Case & Flintwood Front	Case & Veneer Front	Case & Front	Case & Front
2558	2653	2720	4600	4822
2981	3076	3154	4859	5095

**ACCESSORY BUNDLE B (B)**

SOURCE LAMINATE			FLINTWOOD	VENEER
Case & Front	Case & Flintwood Front	Case & Veneer Front	Case & Front	Case & Front
2657	2751	2823	4699	4920
3081	3177	3255	4958	5195

If Mica/Accent is specified, add 52  
 If USB is specified, add 319  
 If Digital Lock is specified, add 579

**H T A B**  
**Storage Cube**

Storage Cube is a mobile personal storage unit that fits casually under the stage. It can be used as extra storage to optimize inaccessible areas under the worksurfaces or a more cost-efficient alternative to low credenzas and pedestals.

**WHAT'S INCLUDED**

1 Storage Cube with casters and repositionable metal divider

**NOTES**

Secondary Finish applies to the front of the unit.

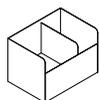

**PRODUCT OPTIONS**

Height	Depth	Width	Primary Finish	Secondary Finish	Base Finish
15	13	18	Foundation Mica Accent	Foundation Mica Accent	Source Laminate

**SAMPLE ORDER CODE**

<b>HTAB 15</b>	<b>13</b>	<b>18</b>	<b>74</b>	<b>74</b>	<b>LY</b>
----------------	-----------	-----------	-----------	-----------	-----------

**PRICING**

Foundation Primary Finish	Accent/Mica Primary Finish
504	520

If Mica/Accent Secondary Finish is specified, add 14



storage accessories



# product map

## H T A N Bookcase Fascia Add-On

Page 532

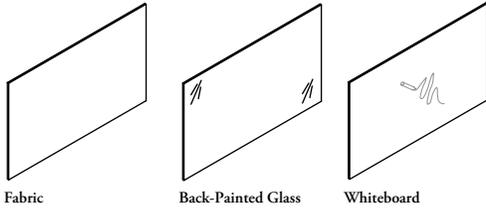

Fabric

Back-Painted Glass

Whiteboard

## H T A Z Hinged Door Stacker Fascia Add-On

Page 536

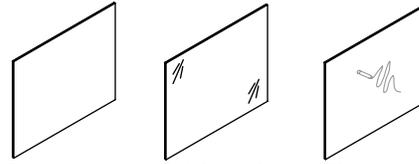

Fabric

Back-Painted Glass

Whiteboard

## H T A S Stage Spacer Block

Page 538

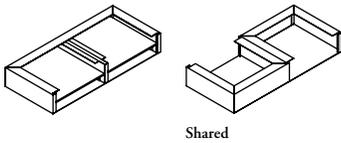

Shared

## H T A D Variable Bookcase Bookend

Page 539



## H T A C Cushion

Page 540

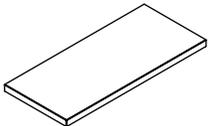

## H T A F Horizontal Filing Insert

Page 541

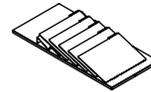

## H T A T Mobile Cubby Tray

Page 542

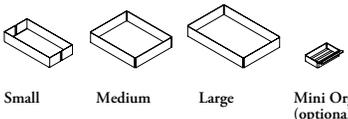

Small

Medium

Large

Mini Organizer (optional)

## H T A G Mini Tray Organizer

Page 543



## product map

**H T A K** Accessory Bundle

Page 544

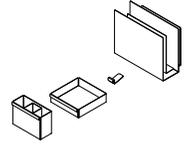

**H T A R** Side Filer Boot Tray

Page 545

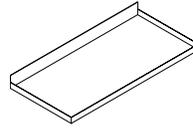



# storage accessories

## HTAN

### Bookcase Fascia Add-On

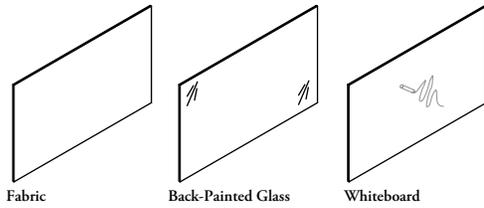

#### WHAT'S INCLUDED

One fascia, velcro.

#### NOTES

Applicable to Bookcase Stackers (HTSB, HTSBS, HTSBF, HTSBW). See *Storage* section for more details

Bookcase style Single-Sided (SA) and Single-Sided with Open Through Top (SB) are only available in widths 24" - 48".

Bookcase style Single-Sided with Open Through Top (SB) and Shared with Open Through Top (DB) are only available in height 45".

Bookcase style Single-Sided with Open Through Top (SB), Shared (DA) and Shared with Open Through Top (DB) are available in width 24".

Height 45" is not available in width 24".

#### PRODUCT OPTIONS

Configuration	Style of Bookcase	Height of Bookcase	Width of Bookcase	Finish
<b>F</b> Fabric	<b>SA</b> Single Sided	21, 30, 45	24, 30, 36, 42, 48, 54, 60, 66, 72	Fabric
<b>G</b> Back-Painted Glass	<b>SB</b> Single Sided with Open Through Top			<b>K1</b> Storm White
<b>W</b> Whiteboard	<b>DA</b> Shared			<b>K7</b> Very White
	<b>DB</b> Shared with Open Through Top			<b>J6</b> Gris
				<b>WB</b> Whiteboard

#### SAMPLE ORDER CODE

<b>HTAN F</b>	<b>DB</b>	<b>30</b>	<b>36</b>	<b>K671</b>
---------------	-----------	-----------	-----------	-------------

#### DIMENSIONS INCHES / MM

H	W
21 / 533	24 / 610
21 / 533	30 / 762
21 / 533	36 / 914
21 / 533	42 / 1066
21 / 533	48 / 1219
30 / 762	24 / 610
30 / 762	30 / 762
30 / 762	36 / 914
30 / 762	42 / 1066
30 / 762	48 / 1219
45 / 1143	30 / 762
45 / 1143	36 / 914
45 / 1143	42 / 1066
45 / 1143	48 / 1219

#### PRICING

##### FABRIC (F)

##### SINGLE SIDED (SA)

COM/	Gr. A	Gr. 1	Gr. 2	Gr. 3	Gr. 4	Gr. 5	Gr. 6	Gr. 7
100	103	110	112	115	119	122	126	
104	111	113	117	121	123	127	129	
128	131	134	141	145	151	154	158	
151	154	158	161	166	175	179	183	
171	176	181	186	191	197	205	210	
145	151	154	158	161	165	175	179	
153	157	160	164	171	178	182	186	
182	187	191	202	208	211	217	223	
213	218	225	234	241	247	255	264	
243	250	258	266	273	282	292	299	
228	238	242	249	257	265	272	281	
273	284	292	300	309	316	330	338	
317	330	339	347	359	370	383	393	
367	375	390	399	409	424	436	451	

##### SINGLE SIDED WITH OPEN THROUGH TOP (SB)

COM	Gr. A	Gr. 1	Gr. 2	Gr. 3	Gr. 4	Gr. 5	Gr. 6	Gr. 7
n/a	n/a	n/a	n/a	n/a	n/a	n/a	n/a	n/a
n/a	n/a	n/a	n/a	n/a	n/a	n/a	n/a	n/a
n/a	n/a	n/a	n/a	n/a	n/a	n/a	n/a	n/a
n/a	n/a	n/a	n/a	n/a	n/a	n/a	n/a	n/a
n/a	n/a	n/a	n/a	n/a	n/a	n/a	n/a	n/a
n/a	n/a	n/a	n/a	n/a	n/a	n/a	n/a	n/a
n/a	n/a	n/a	n/a	n/a	n/a	n/a	n/a	n/a
n/a	n/a	n/a	n/a	n/a	n/a	n/a	n/a	n/a
n/a	n/a	n/a	n/a	n/a	n/a	n/a	n/a	n/a
n/a	n/a	n/a	n/a	n/a	n/a	n/a	n/a	n/a
153	157	160	164	171	178	182	186	
182	187	191	202	208	211	217	223	
213	218	225	234	241	247	255	264	
243	250	258	266	273	282	292	299	

Pricing is continued on the following page.

**H T A N**  
**Bookcase Fascia Add-On**  
**(Continued)**

**DIMENSIONS**  
**INCHES / MM**

**PRICING**

		<b>FABRIC (F) (Continued)</b>															
		<b>SHARED (DA)</b>				<b>SHARED WITH OPEN THROUGH TOP (DB)</b>											
		COM/ Gr. A	Gr. 1	Gr. 2	Gr. 3	Gr. 4	Gr. 5	Gr. 6	Gr. 7	COM/ Gr. A	Gr. 1	Gr. 2	Gr. 3	Gr. 4	Gr. 5	Gr. 6	Gr. 7
21 / 533	30 / 762	54	55	57	58	60	61	63	66	n/a	n/a	n/a	n/a	n/a	n/a	n/a	n/a
21 / 533	36 / 914	63	66	69	70	73	74	78	81	n/a	n/a	n/a	n/a	n/a	n/a	n/a	n/a
21 / 533	42 / 1066	74	80	81	83	85	87	89	90	n/a	n/a	n/a	n/a	n/a	n/a	n/a	n/a
21 / 533	48 / 1219	85	88	89	92	97	98	100	103	n/a	n/a	n/a	n/a	n/a	n/a	n/a	n/a
21 / 533	54 / 1372	96	98	100	103	106	112	114	119	n/a	n/a	n/a	n/a	n/a	n/a	n/a	n/a
21 / 533	60 / 1524	104	111	113	117	121	123	127	129	n/a	n/a	n/a	n/a	n/a	n/a	n/a	n/a
21 / 533	66 / 1676	119	122	126	128	131	136	141	145	n/a	n/a	n/a	n/a	n/a	n/a	n/a	n/a
21 / 533	72 / 1829	128	131	134	141	145	151	154	158	n/a	n/a	n/a	n/a	n/a	n/a	n/a	n/a
30 / 762	30 / 762	78	81	82	84	87	88	90	94	n/a	n/a	n/a	n/a	n/a	n/a	n/a	n/a
30 / 762	36 / 914	90	94	97	99	101	104	111	113	n/a	n/a	n/a	n/a	n/a	n/a	n/a	n/a
30 / 762	42 / 1066	104	111	113	117	121	123	127	129	n/a	n/a	n/a	n/a	n/a	n/a	n/a	n/a
30 / 762	48 / 1219	123	126	129	133	136	142	148	152	n/a	n/a	n/a	n/a	n/a	n/a	n/a	n/a
30 / 762	54 / 1372	136	142	148	152	157	159	163	167	n/a	n/a	n/a	n/a	n/a	n/a	n/a	n/a
30 / 762	60 / 1524	153	157	160	164	171	178	182	186	n/a	n/a	n/a	n/a	n/a	n/a	n/a	n/a
30 / 762	66 / 1676	165	174	179	182	187	193	203	208	n/a	n/a	n/a	n/a	n/a	n/a	n/a	n/a
30 / 762	72 / 1829	182	187	191	202	208	211	217	223	n/a	n/a	n/a	n/a	n/a	n/a	n/a	n/a
45 / 1143	30 / 762	111	113	115	121	124	127	129	133	78	81	82	84	87	88	90	94
45 / 1143	36 / 914	130	134	140	143	149	153	157	160	90	94	97	99	101	104	111	113
45 / 1143	42 / 1066	153	157	160	164	171	178	182	186	104	111	113	117	121	123	127	129
45 / 1143	48 / 1219	176	181	184	189	195	205	210	214	123	126	129	133	136	142	148	152
45 / 1143	54 / 1372	194	204	209	213	219	225	234	241	136	142	148	152	157	159	163	167
45 / 1143	60 / 1524	217	223	233	240	247	251	259	269	153	157	160	164	171	178	182	186
45 / 1143	66 / 1676	240	246	254	263	270	276	285	295	165	174	179	182	187	193	203	208
45 / 1143	72 / 1829	263	269	278	285	295	303	311	321	182	187	191	202	208	211	217	223

Pricing is continued on the following page.

## H T A N

### Bookcase Fascia Add-On (Continued)

#### DIMENSIONS INCHES / MM

#### PRICING

DIMENSIONS		PRICING			
INCHES / MM		BACK-PAINTED GLASS (G)			
H	W	SINGLE (SA)	SINGLE WITH OPEN THROUGH TOP (SB)	SHARED (DA)	SHARED WITH OPEN THROUGH TOP (DB)
21 / 533	24 / 610	398	n/a	n/a	n/a
21 / 533	30 / 762	421	n/a	210	n/a
21 / 533	36 / 914	503	n/a	250	n/a
21 / 533	42 / 1066	586	n/a	294	n/a
21 / 533	48 / 1219	671	n/a	337	n/a
21 / 533	54 / 1372	n/a	n/a	376	n/a
21 / 533	60 / 1524	n/a	n/a	421	n/a
21 / 533	66 / 1676	n/a	n/a	461	n/a
21 / 533	72 / 1829	n/a	n/a	503	n/a
30 / 762	24 / 610	571	n/a	n/a	n/a
30 / 762	30 / 762	600	n/a	299	n/a
30 / 762	36 / 914	717	n/a	361	n/a
30 / 762	42 / 1066	837	n/a	421	n/a
30 / 762	48 / 1219	955	n/a	480	n/a
30 / 762	54 / 1372	n/a	n/a	541	n/a
30 / 762	60 / 1524	n/a	n/a	600	n/a
30 / 762	66 / 1676	n/a	n/a	657	n/a
30 / 762	72 / 1829	n/a	n/a	717	n/a
45 / 1143	30 / 762	897	600	428	299
45 / 1143	36 / 914	1076	717	514	361
45 / 1143	42 / 1066	1256	837	600	421
45 / 1143	48 / 1219	1437	955	685	480
45 / 1143	54 / 1372	n/a	n/a	769	541
45 / 1143	60 / 1524	n/a	n/a	856	600
45 / 1143	66 / 1676	n/a	n/a	942	657
45 / 1143	72 / 1829	n/a	n/a	1027	717

Pricing is continued on the following page.

**H T A N**  
**Bookcase Fascia Add-On**  
**(Continued)**

**DIMENSIONS**  
**INCHES / MM**

**PRICING**

DIMENSIONS INCHES / MM		WHITEBOARD (W)			
		SINGLE (SA)	SINGLE WITH OPEN THROUGH TOP (SB)	SHARED (DA)	SHARED WITH OPEN THROUGH TOP (DB)
H	W				
21 / 533	24 / 610	51	n/a	n/a	n/a
21 / 533	30 / 762	53	n/a	48	n/a
21 / 533	36 / 914	63	n/a	54	n/a
21 / 533	42 / 1066	78	n/a	61	n/a
21 / 533	48 / 1219	88	n/a	70	n/a
21 / 533	54 / 1372	n/a	n/a	83	n/a
21 / 533	60 / 1524	n/a	n/a	92	n/a
21 / 533	66 / 1676	n/a	n/a	103	n/a
21 / 533	72 / 1829	n/a	n/a	117	n/a
30 / 762	24 / 610	55	n/a	n/a	n/a
30 / 762	30 / 762	58	n/a	53	n/a
30 / 762	36 / 914	74	n/a	63	n/a
30 / 762	42 / 1066	92	n/a	78	n/a
30 / 762	48 / 1219	111	n/a	88	n/a
30 / 762	54 / 1372	n/a	n/a	103	n/a
30 / 762	60 / 1524	n/a	n/a	122	n/a
30 / 762	66 / 1676	n/a	n/a	140	n/a
30 / 762	72 / 1829	n/a	n/a	156	n/a
45 / 1143	30 / 762	70	70	48	48
45 / 1143	36 / 914	96	96	54	54
45 / 1143	42 / 1066	122	122	61	61
45 / 1143	48 / 1219	148	148	70	70
45 / 1143	54 / 1372	n/a	n/a	83	83
45 / 1143	60 / 1524	n/a	n/a	92	92
45 / 1143	66 / 1676	n/a	n/a	103	103
45 / 1143	72 / 1829	n/a	n/a	117	117

# storage accessories

## HTAZ

### Hinged Door Stacker Fascia Add-On

#### WHAT'S INCLUDED

One fascia, velcro.

#### NOTES

Applicable to Hinged Door Stackers (HTSSS) and Shared Hinged Door Stacker (HTSSD). See *Storage* section for more details.

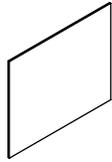

Fabric

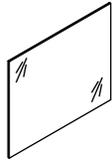

Back-Painted Glass



Whiteboard

#### PRODUCT OPTIONS

Configuration	Style of Stacker	Height of Stacker	Width of Stacker	Finish
<b>F</b> Fabric	<b>ZS</b> Single Sided	21, 30, 45	30, 36, 42, 48	Fabric
<b>G</b> Back-Painted Glass	<b>ZD</b> Shared			<b>K1</b> Storm White
<b>W</b> Whiteboard				<b>K7</b> Very White
				<b>J6</b> Gris
				<b>WB</b> Whiteboard

#### SAMPLE ORDER CODE

<b>HTAZ F</b>	<b>ZD</b>	<b>21</b>	<b>36</b>	<b>K671</b>
---------------	-----------	-----------	-----------	-------------

#### DIMENSIONS INCHES / MM

H	W
21 / 533	30 / 762
21 / 533	36 / 914
21 / 533	42 / 1066
21 / 533	48 / 1219
30 / 762	30 / 762
30 / 762	36 / 914
30 / 762	42 / 1066
30 / 762	48 / 1219
45 / 1143	30 / 762
45 / 1143	36 / 914
45 / 1143	42 / 1066
45 / 1143	48 / 1219

#### PRICING

##### FABRIC (F)

##### SINGLE SIDED (ZS)

COM/ Gr. A	Gr. 1	Gr. 2	Gr. 3	Gr. 4	Gr. 5	Gr. 6	Gr. 7
104	111	113	117	121	123	127	129
128	131	134	141	145	151	154	158
151	154	158	161	166	175	179	183
171	176	181	186	191	197	205	210
153	157	160	164	171	178	182	186
182	187	191	202	208	211	217	223
213	218	225	234	241	247	255	264
243	250	258	266	273	282	292	299
228	238	242	249	257	265	272	281
273	284	292	300	309	316	330	338
317	330	339	347	359	370	383	393
367	375	390	399	409	424	436	451

##### SHARED (ZD)

COM Gr. A	Gr. 1	Gr. 2	Gr. 3	Gr. 4	Gr. 5	Gr. 6	Gr. 7
54	55	57	58	60	61	63	66
63	66	69	70	73	74	78	81
74	80	81	83	85	87	89	90
85	88	89	92	97	98	100	103
78	81	82	84	87	88	90	94
90	94	97	99	101	104	111	113
104	111	113	117	121	123	127	129
123	126	129	133	136	142	148	152
115	119	123	126	129	131	136	142
136	142	148	152	157	159	163	167
159	163	171	176	181	184	189	197
182	187	191	202	208	211	217	223

Pricing is continued on the following page.



**H T A Z**  
**Hinged Door Stacker Fascia**  
**Add-On (Continued)**

**DIMENSIONS**  
**INCHES / MM**

H	W
21 / 533	30 / 762
21 / 533	36 / 914
21 / 533	42 / 1066
21 / 533	48 / 1219
30 / 762	30 / 762
30 / 762	36 / 914
30 / 762	42 / 1066
30 / 762	48 / 1219
45 / 1143	30 / 762
45 / 1143	36 / 914
45 / 1143	42 / 1066
45 / 1143	48 / 1219

H	W
21 / 533	30 / 762
21 / 533	36 / 914
21 / 533	42 / 1066
21 / 533	48 / 1219
30 / 762	30 / 762
30 / 762	36 / 914
30 / 762	42 / 1066
30 / 762	48 / 1219
45 / 1143	30 / 762
45 / 1143	36 / 914
45 / 1143	42 / 1066
45 / 1143	48 / 1219

**PRICING**

**BACK-PAINTED GLASS (G)**

SINGLE SIDED (ZS)	SHARED (ZD)
421	210
503	250
586	294
671	337
600	299
717	361
837	421
955	480
897	451
1076	541
1256	630
1437	717

**WHITEBOARD (W)**

SINGLE SIDED (ZS)	SHARED (ZD)
53	53
58	58
66	66
71	71
55	55
60	60
69	69
74	74
71	71
84	84
97	97
111	111

## HTAS

### Stage Spacer Block

The Stage Spacer Block is used to elevate stackers that are placed on Stage Credenzas to reach the stage height.

#### WHAT'S INCLUDED

One case, single or shared (as specified).

#### NOTES

Width 24" is not available if configuration Shared (D) is specified.

Handedness applies to Single (S) configuration only.

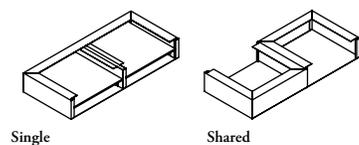

#### PRODUCT OPTIONS

Configuration	Width	Handedness	Case Finish
<b>S</b> Single <b>D</b> Shared	24, 30, 36, 42, 48	<b>L</b> Left <b>R</b> Right	Foundation Mica Accent

#### SAMPLE ORDER CODE

<b>HTAS D</b>	<b>48</b>	<b>L</b>	<b>74</b>
---------------	-----------	----------	-----------

#### DIMENSIONS INCHES / MM

W
24 / 609
30 / 762
36 / 914
42 / 1067
48 / 1219

#### PRICING

##### SINGLE

Foundation	Accent/Mica
180	187
184	193
189	203
326	341
337	351

##### SHARED

Foundation	Accent/Mica
n/a	n/a
311	328
328	342
342	362
362	377

**WHAT'S INCLUDED**

One bookend.

**NOTES**

Bookends can be used with bookcase stackers.

The 12" height is specifically used for 30" tall or shorter Variable Bookcase Stacker (HTSBV).

**HTAD  
Variable Bookcase Bookend**

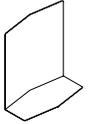

**PRODUCT OPTIONS**

Height	Finish
12, 14	Foundation Mica Accent

**SAMPLE ORDER CODE**

<b>HTAD 12</b>	<b>74</b>
----------------	-----------

**DIMENSIONS  
INCHES / MM**

W
12 / 305
14 / 356

**PRICING**

Foundation	Accent/Mica
73	78
82	85

# storage accessories

## HTAC Cushion

Cushion can be applied to either credenzas or the stage for soft seating in various environments.

### WHAT'S INCLUDED

One cushion. velcro

### NOTES

Cushion can be applied to all elevated credenzas and/or the Stage.

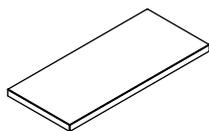

### PRODUCT OPTIONS

Width	Seat Finish
24, 30, 36, 42, 48	Upholstery Fabric

### SAMPLE ORDER CODE

<b>HTAC 36</b>	<b>A120</b>
----------------	-------------

### DIMENSIONS INCHES / MM

W
24 / 609
30 / 762
36 / 914
42 / 1067
48 / 1219

### PRICING

COM/		Gr. 1	Gr. 2	Gr. 3	Gr. 4	Gr. 5	Gr. 6	Gr. 7	Gr. 8	Gr. 9	Gr. 10
		476	549	578	606	635	666	700	734	771	808
		523	604	634	666	699	732	768	807	850	889
		586	675	709	743	781	821	861	902	950	996
		648	746	783	823	863	907	952	1000	1051	1102
		715	821	861	906	950	997	1049	1100	1155	1213

Horizontal Filing Insert is sized to fit into Box drawers for better organization and convenient filing.

**WHAT'S INCLUDED**

One liner tray, file dividers.

**NOTES**

Width	Number of file divider
16	2
18	3
21	4
24	3
30	5

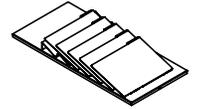

Not all drawers are the same. Refer to the *Application Guides* for specific guidelines.

**PRODUCT OPTIONS**

Width	Liner Finish	Divider Finish
16, 18, 21, 24, 30	Foundation Mica Accent	Foundation Mica Accent

**SAMPLE ORDER CODE**

<b>HTAF 24</b>	<b>74</b>	<b>74</b>
----------------	-----------	-----------

**DIMENSIONS  
INCHES / MM**

W
16 / 406
18 / 457
21 / 533
24 / 609
30 / 762

**PRICING**

	Foundation	Accent/Mica
	94	98
	111	115
	124	129
	114	121
	145	153

# storage accessories

## HTAT Mobile Cubby Tray

### WHAT'S INCLUDED

One tray with Geo Lore Fabric liner, 1 mini organizer/handle (if specified).

### NOTES

Mini Organizer is finished in Soft Gris.

The small Mobile Cubby Tray has an optional small Mini Tray Organizer, while the medium and large sizes have an optional large Mini Tray Organizer.

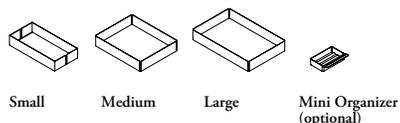

### PRODUCT OPTIONS

Style	Tray Finish	Mini Tray Organizer
<b>S</b> Small	Foundation	<b>N</b> No
<b>M</b> Medium	Mica	<b>Y</b> Yes
<b>L</b> Large	Accent	

### SAMPLE ORDER CODE

<b>HTAT S</b>	<b>74</b>	<b>Y</b>
---------------	-----------	----------

### DIMENSIONS CODE

### PRICING

	Foundation	Accent/Mica
Small (S)	97	103
Medium (M)	117	124
Large (L)	140	148

If Mini Tray Organizer is specified for Small, add 28 for each

If Mini Tray Organizer is specified for Medium or Large, add 32 for each

**WHAT'S INCLUDED**

One mini tray organizer

**NOTES**

Finished in Soft Gris only.

**HTAG**  
**Mini Tray Organizer**

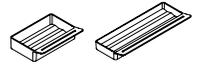

**PRODUCT OPTIONS**

Style
S Small
L Large

**SAMPLE ORDER CODE**

**HTAG S**

**DIMENSIONS  
CODE**

**PRICING**

Small (S)	28
Large (L)	32

## HTAK Accessory Bundle

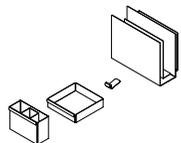

Specifically designed to work with Side Filer and Mini Side Filer, Accessory Bundles help organize the interior and provide functional organization.

### WHAT'S INCLUDED

Accessory Bundle A: 1 pen pocket, 1 hanging tray, 1 headphone hook

Accessory Bundle B: 1 pen pocket, 1 hanging tray, 1 headphone hook, 1 paper filer

### NOTES

Compatible with standard accessory rails.

### PRODUCT OPTIONS

Configuration	Metal Paint Finish
A Accessory Bundle A	Foundation
B Accessory Bundle B	Mica
	Accent

### SAMPLE ORDER CODE

HTAK A	74
--------	----

### PRICING

Configuration	Foundation	Accent/Mica
A	175	181
B	268	273



The Side Filer Boot Tray provides additional functionality for the bottom shelf of the Side Filer or Mini Side Filer. 180° reversible, it offers easier access to contents of the lower shelf in Mini Side Filer and secure containment for the items at the bottom of the Side Filer.

## HTAR Side Filer Boot Tray

**WHAT'S INCLUDED**

1 boot tray with hardware

**NOTES**

Boot Tray is always 13" deep. The following chart outlines size compatibility for different widths.

12" - 24" deep Side Filer, 32" deep Side Filer

18" - 30" deep Side Filer, 38" deep Side Filer

20" - 23" deep Mini Side Filer, 24" deep Side Filer w/o coat

26" - 29" deep Mini Side Filer

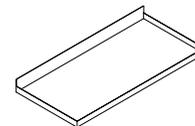

**PRODUCT OPTIONS**

Width	Metal Paint Finish
12, 18, 20, 26	Foundation Mica Accent

**SAMPLE ORDER CODE**

<b>HTAR 20</b>	74
----------------	----

**DIMENSIONS  
INCHES / MM**

W
12 / 305
18 / 457
20 / 508
26 / 660

**PRICING**

Foundation	Accent/Mica
94	100
94	100
110	115
110	115

electrics

# product map

**H T E B F Base Feed**

Page 551



**H T E B S Split Base Feed**

Page 552



**H T E B C Chicago Base Feed**

Page 553



**H T E F B Base Feed Cover**

Page 554



**H T E C F Ceiling Feed**

Page 555



**H T E C C Chicago Ceiling Feed**

Page 556



**H T E B H Power Harness**

Page 557



**H T E F P Flexible Power Module**

Page 558

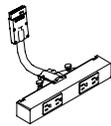

**H T E F C Chicago Power Module**

Page 560

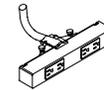

**H T E F S Simple Stage Power Box**

Page 561

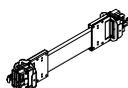

**H T E M Multi-Circuit Desk Power Module**

Page 562



**H T E P M C Chicago Power Box for HA Stage Module**

Page 563



## product map

**H T E M C** Chicago Desk Power Module

Page 564



**H T E P M** Power Module for HA Stage

Page 565



**H T E C B** Communication Box

Page 566



---

**H T E L** Power Pole

Page 567



**H T E A** Access Door for Multi-Circuit Desk

Page 568



**H T E G** Rectangle Grommet

Page 569



---

**H T E N** Multi-Circuit Desk Housing

Page 570

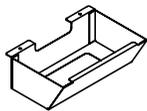

**H T E J I C** I-Connector

Page 571



**H T E J D B** Four-Way Splitter

Page 572

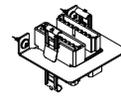

---

**H T E W** Wire Clips

Page 573

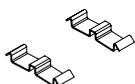

**H T E T** Worksurface Cable Tray

Page 574

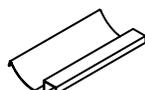

**H T E R O** Receptacle Outlet

Page 575



# product map

**H T E K Simple Stage Power Cover**

Page 576

**H T E E E Data Extender Plate**

Page 577

**H T E Z Simple Stage Data Cover**

Page 578



**H T E X Chicago Junction Box**

Page 579

**V E S International Stage Mount Kit**

Page 580

**H T E P C Power Conservation System**

Page 581

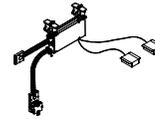

**V B C U CALA Power Module**

Page 582

**V B P H CALA Jumper Power Harness**

Page 583

**V B P U CALA Power In Feed**

Page 584

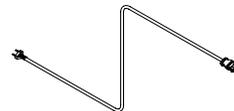
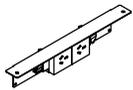

**V B W B CALA Power Station**

Page 585





The Base Feed delivers power to a Stage at base level and provides entry for data communication cables.

# HTEBF Base Feed

### WHAT'S INCLUDED

1 base feed, 72" liquid tight conduit, data/communications bezel mounting hardware.

### NOTES

Power Harness (HTEH) is required to route power to a power box or distribution box.

Available in 8-Wire Isolated Ground (8T), 7 Wire Non Isolated Ground (7T), 8-Wire Dual Ground (8K) and 7 Wire Dual Non Isolated (7K) wiring systems.



### PRODUCT OPTIONS

Wire Systems	Length	Stage Module Size	Country of Installation	PVC Option
8T 8-Wire Isolated Ground	072	SM For Frame Modules 60" or less	A Canada/USA	Standard
8K 8-Wire Dual Isolated		LG For Frame Modules 66" or more		V PVC Free
7T 7-Wire Non Isolated Ground				
7K 7-Wire Dual Non Isolated				

### SAMPLE ORDER CODE

<b>HTEBF 8K</b>	<b>072</b>	<b>LG</b>	<b>A</b>	<b>V</b>
-----------------	------------	-----------	----------	----------

### DIMENSIONS

Stage Module Size
SM
LG

### PRICING

#### 8-WIRE ISOLATED GROUND (8T) & 7-WIRE NON ISOLATED GROUND (7T)

	Standard	PVC Free
SM	476	522
LG	660	709

#### 8-WIRE DUAL ISOLATED (8K) & 7-WIRE DUAL NON ISOLATED (7K)

	Standard	PVC Free
SM	597	655
LG	781	838

## HTEBS

### Split Base Feed

The Split Base Feed is hard-wired to the building power supply in two places. It feeds power into the Panel.

#### WHAT'S INCLUDED

1 split base feed, liquid tight conduit (72"), 1 wiring junction box, mounting hardware.

#### NOTES

Split Base Feed brackets is finished in Platinum.



#### PRODUCT OPTIONS

Wire Systems	Length	Country of Installation	PVC Option
<b>8T</b> 8-Wire Isolated Ground <b>8K</b> 8-Wire Dual Isolated <b>7T</b> 7-Wire Non Isolated Ground <b>7K</b> 7-Wire Dual Non Isolated	072	A Canada/USA	Standard <b>V</b> PVC Free

#### SAMPLE ORDER CODE

<b>HTEBS 8K</b>	<b>072</b>	<b>A</b>	<b>V</b>
-----------------	------------	----------	----------

#### PRICING

##### 8-WIRE ISOLATED GROUND (8T) & 7-WIRE NON ISOLATED GROUND (7T)

Standard	PVC Free
429	548

##### 8-WIRE DUAL ISOLATED (8K) & 7-WIRE DUAL NON ISOLATED (7K)

Standard	PVC Free
495	628



The Chicago Base Feed delivers power to a Stage at base level and provides entry for data communication feeds.

**WHAT'S INCLUDED**

1 base feed, 72" liquid tight conduit.

**HTEBC  
Chicago Base Feed**



**PRODUCT OPTIONS**

Length	Country of Installation
072	A Canada/USA

**SAMPLE ORDER CODE**

HTEBC 072	A
-----------	---

**PRICING**

427
-----

**H T E F B**  
**Base Feed Cover**

The Base Feed Cover provides a seamless vertical trim cover of the base feed to the interior or exterior of the Stage communication cables.

**WHAT'S INCLUDED**

1 base feed cover and mounting hardware.



**PRODUCT OPTIONS**

Application	Finish
<b>D</b> Interior of Stage <b>E</b> Exterior of Stage	Foundation Mica Accent

**SAMPLE ORDER CODE**

<b>HTEFB D</b>	<b>74</b>
----------------	-----------

**PRICING**

Foundation	Accent/Mica
133	141

The Ceiling Feed is used to route power from the ceiling, through the Power Pole (HTEL), to the Stage.

## HTECF Ceiling Feed

**WHAT'S INCLUDED**

1 ceiling feed.

**NOTES**

Connects to power source above the ceiling and routes through the Power Pole and connects to a Power Module.

Available in 8-Wire Isolated Ground (8T), 7 Wire Non Isolated Ground (7T), 8-Wire Dual Ground (8K) and 7 Wire Dual Non Isolated (7K) wiring systems.

Cable lengths include 120" & 144".



**PRODUCT OPTIONS**

Wire Systems	Length	Country of Installation	PVC Option
<b>8T</b> 8-Wire Isolated Ground <b>8K</b> 8-Wire Dual Isolated <b>7T</b> 7-Wire Non Isolated Ground <b>7K</b> 7-Wire Dual Non Isolated	120, 144	A Canada/USA	Standard <b>V</b> PVC Free

**SAMPLE ORDER CODE**

<b>HTECF 8T</b>	<b>120</b>	<b>A</b>	<b>V</b>
-----------------	------------	----------	----------

**DIMENSIONS  
INCHES / MM**

L
120 / 3048
144 / 3658

**PRICING**

**8-WIRE ISOLATED GROUND (8T) & 7-WIRE NON ISOLATED GROUND (7T)**

Standard	PVC Free
341	376
361	397

**8-WIRE DUAL ISOLATED (8K) & 7-WIRE DUAL NON ISOLATED (7K)**

Standard	PVC Free
415	455
435	479

**HTECC**  
**Chicago Ceiling Feed**

The Chicago Ceiling Feed is used to route power from the ceiling, through the Power Pole (HTEL), to the Stage.

**WHAT'S INCLUDED**  
 1 Chicago ceiling feed.



**PRODUCT OPTIONS**

Length	Country of Installation
120, 144	A Canada/USA

**SAMPLE ORDER CODE**

<b>HTECC 120</b>	<b>A</b>
------------------	----------

**DIMENSIONS**  
**INCHES / MM**

L
120 / 3048
144 / 3658

**PRICING**

233
281

The Power Harness routes power from one Stage to another.

**WHAT'S INCLUDED**

1 power harness.

**NOTES**

Power Harness is non-directional and connects power between a Four-Way Splitter or can be separately connected to an I-Connector, both must be specified separately.

Compatible with 7K, 7T, 8K and 8T wire systems.

Standard and PVC free options available.

**HTEBH**  
**Power Harness**



**PRODUCT OPTIONS**

Wire Systems	Length	Country of Installation	PVC Option
<b>8T</b> 8-Wire Isolated Ground <b>8K</b> 8-Wire Dual Isolated	018, 021, 024, 030, 036, 042, 048, 054, 060, 066, 072, 078, 084, 096, 108, 120, 144	A Canada/USA	Standard <b>V</b> PVC Free

**SAMPLE ORDER CODE**

<b>HTEBH 8K</b>	<b>072</b>	<b>A</b>	<b>V</b>
-----------------	------------	----------	----------

**DIMENSIONS**  
**INCHES / MM**

L
18 / 457
21 / 533
24 / 610
30 / 762
36 / 915
42 / 1067
48 / 1219
54 / 1372
60 / 1524
66 / 1676
72 / 1829
78 / 1981
84 / 2134
96 / 2438
108 / 2743
120 / 3048
144 / 3658

**PRICING**

**8-WIRE ISOLATED GROUND (8T)**

Standard	PVC Free
205	233
205	233
205	233
205	233
212	238
216	240
219	242
223	246
228	250
233	259
235	268
243	272
254	278
269	296
287	312
307	331
325	347

**8-WIRE DUAL ISOLATED (8K)**

Standard	PVC Free
250	266
250	266
250	266
250	266
256	272
263	282
266	292
270	298
273	303
278	301
282	312
294	325
304	337
325	359
335	381
347	401
362	425

## HTEFP

### Flexible Power Module

A Flexible Power Modules provides two duplexes mounted to the Power Rail on one side of the Stage. It's location is user adjustable along the Power Rail.

#### WHAT'S INCLUDED

1 flexible power module (2 duplexes), mounting brackets.

#### NOTES

Power Module and Duplexes available in a Very White and Gris finish.

PVC option available.

USB Receptacle Style is only available for Circuit one.

Receptacle finish will automatically match the finish option selected.

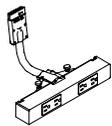

#### PRODUCT OPTIONS

Wire Systems	Cable Length	Receptacle Style	Receptacle Style	
<b>8T</b> 8-Wire Isolated Ground	024, 036, 048	<b>S</b> Standard 15 Amp	<b>1A</b> Circuit 1 & A (Use with 7T & 7K Only)	<b>16</b> Circuit 1 & 6 (use with 8K only)
<b>8K</b> 8-Wire Dual Isolated		<b>T</b> T-Slot 20 Amp	<b>1B</b> Circuit 1 & B (Use with 7K Only)	<b>22</b> Circuit 1 & 2
<b>7T</b> 7-Wire Non Isolated Ground			<b>2A</b> Circuit 2 & A (Use with 7T & 7K Only)	<b>23</b> Circuit 2 & 3 (use with 8T only)
<b>7K</b> 7-Wire Dual Non Isolated			<b>3A</b> Circuit 3 & A (Use with 7T Only)	<b>25</b> Circuit 2 & 5
			<b>AA</b> Circuit A (Use with 7T & 7K Only)	<b>26</b> Circuit 2 & 6 (use with 8K only)
			<b>AB</b> Circuit A & B (Use with 7T & 7K Only)	<b>33</b> Circuit 3 & 3 (use with 8T only)
			<b>BB</b> Circuit B (Use with 7K Only)	<b>35</b> Circuit 3 & 5 (use with 8T only)
			<b>11</b> Circuit 1	<b>55</b> Circuit 5 & 5
			<b>12</b> Circuit 1 & 2	<b>56</b> Circuit 5 & 6 (use with 8K only)
			<b>13</b> Circuit 1 & 3 (use with 8T only)	<b>66</b> Circuit 6 & 6 (use with 8K only)
			<b>15</b> Circuit 1 & 5	<b>U1</b> USB & Circuit 1

#### SAMPLE ORDER CODE

<b>HTEFP 8T</b>	<b>036</b>	<b>T</b>	<b>U1</b>
-----------------	------------	----------	-----------

#### PRODUCT OPTIONS (CONTINUED)

Country of Installation	Finish	PVC Option
<b>A</b> Canada/USA	<b>26</b> Soft Gris <b>83</b> Very White	Standard <b>V</b> PVC Free

#### SAMPLE ORDER CODE (CONTINUED)

<b>A</b>	<b>26</b>	<b>V</b>
----------	-----------	----------

See Pricing on the following page.

**H T E F P**  
**Flexible Power Module (Continued)**

**DIMENSIONS**  
**INCHES / MM**

L
024 / 610
036 / 915
048 / 1219

**PRICING**

**8-WIRE ISOLATED GROUND (8T) & 7-WIRE NON ISOLATED GROUND (7T)**

Standard 15 Amp, Circuits	T-Slot 20 Amp, Circuits
390	462
401	479
420	492

**8-WIRE DUAL ISOLATED (8K) & 7-WIRE DUAL NON ISOLATED (7K)**

Standard 15 Amp, Circuits	T-Slot 20 Amp, Circuits
401	479
420	492
432	507

If PVC Free is specified, add 97  
If USB is specified, add 121

# HTEFC

## Chicago Power Module

The Chicago Power Module provides two Duplexes to be mounted to the Stage mount and two Duplexes (on one side) for the Single Sided Stage mount.

### WHAT'S INCLUDED

1 Chicago power module (2 duplexes), mounting brackets.

### NOTES

Power Module is available in a Very White and Gris finish.

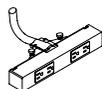

### PRODUCT OPTIONS

Cable Length	Receptacle Style	Country of Installation	Finish	PVC Option
024, 036, 048	<b>S</b> Standard 15 Amp <b>T</b> T-Slot 20 Amp	<b>A</b> Canada/USA	<b>26</b> Soft Gris <b>83</b> Very White	Standard <b>V</b> PVC Free

### SAMPLE ORDER CODE

<b>HTEFC 024</b>	<b>S</b>	<b>A</b>	<b>26</b>	<b>V</b>
------------------	----------	----------	-----------	----------

### DIMENSIONS INCHES / MM

L
024 / 610
036 / 915
048 / 1219

### PRICING

#### STANDARD 15 AMP (S)

Standard	PVC Free
367	401
381	421
395	435

#### T-SLOT 20 AMP (T)

Standard	PVC Free
455	499
469	518
484	534



This Power Box is a module that mounts inside the simple stage to allow the mounting of Receptacle Outlets.

**WHAT'S INCLUDED**

1 power box and mounting hardware.

**NOTES**

Compatible with 7K, 7T, 8K and 8T wire systems. Refer to application guide

**H T E F S**  
**Simple Stage Power Box**

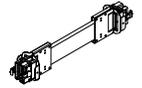

**PRODUCT OPTIONS**

Application	Wire Systems	Country of Installation	PVC Option
<b>S</b> Simple Stage Mounted	<b>8T</b> 8-Wire Isolated Ground <b>8K</b> 8-Wire Dual Isolated	<b>A</b> Canada/USA	Standard <b>V</b> PVC Free

**SAMPLE ORDER CODE**

<b>HTEFS S</b>	<b>8T</b>	<b>A</b>	<b>V</b>
----------------	-----------	----------	----------

**PRICING**

Wire System	Standard	PVC Free
8T	335	369
8K	335	369

# H T E M

## Multi-Circuit Desk Power Module

The Multi-Circuit Desk Power Module provides power and data to a Worksurface.

**WHAT'S INCLUDED**

1 multi-circuit desk power module.

**NOTES**

To used with Multi-Circuit Desk Housing (HTEN), Receptacle Outlet (HTERO) & Accessory Door for Multi-Circuit (HTEA). Each sold separately.



**PRODUCT OPTIONS**

Wire Systems	Country of Installation	PVC Option
<b>8T</b> 8-Wire Isolated Ground <b>8K</b> 8-Wire Dual Isolated	<b>A</b> Canada/USA	Standard <b>V</b> PVC Free

**SAMPLE ORDER CODE**

<b>HTEM 8T</b>	<b>A</b>	<b>V</b>
----------------	----------	----------

**PRICING**

Wire System	Standard	PVC Free
8T	411	450
8K	411	450

The Chicago Power Box for HA Stage Module mounts directly in the Height-Adjustable Module.

**WHAT'S INCLUDED**

1 power module and mounting brackets.

**NOTES**

Available in one sided and Back-to-Back.

**H T E P M C**  
**Chicago Power Box for**  
**HA Stage Module**



**PRODUCT OPTIONS**

Configuration	Country of Installation
A One Sided B Back to Back	A Canada/USA

**SAMPLE ORDER CODE**

<b>HTEPMC B</b>	<b>A</b>
-----------------	----------

**PRICING**

Configuration	
A	367
B	390

# H T E M C

## Chicago Desk Power Module

The Chicago Desk Power Module provides power and data to a Worksurface.

**WHAT'S INCLUDED**

1 hardwire desk power module.

**NOTES**

Is used with Multi-Circuit Desk Housing (HTEN) and Accessory Door for Multi-Circuit (HTEA). Each sold separately.



**PRODUCT OPTIONS**

Receptacle Style	Receptacle Finish	Country of Installation
<b>S</b> Standard 15 Amp	<b>YY</b> Ebony Coordinate	<b>A</b> Canada/USA
<b>T</b> T-Slot 20 Amp	<b>YV</b> Very White Coordinate	

**SAMPLE ORDER CODE**

<b>HTEMC S</b>	<b>YY</b>	<b>A</b>
----------------	-----------	----------

**PRICING**

Style	
S	412
T	497

The Power Module mounts directly in the Height-Adjustable Module and accepts Receptacle Outlets (HTERO) and can accommodate up to four duplex (two on each side).

**WHAT'S INCLUDED**

1 blank module, bezel and mounting brackets.

**NOTES**

Available in 8-Wire Isolated Ground (8T) and 8-Wire Dual Ground (8K) wiring systems.

**H T E P M**  
**Power Module for**  
**HA Stage**

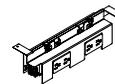

**PRODUCT OPTIONS**

Wire Systems	Country of Installation	PVC Option
<b>8T</b> 8-Wire Isolated Ground <b>8K</b> 8-Wire Dual Isolated	<b>A</b> Canada/USA	Standard <b>V</b> PVC Free

**SAMPLE ORDER CODE**

<b>HTEPM 8T</b>	<b>A</b>	<b>V</b>
-----------------	----------	----------

**PRICING**

Wire System	Standard	PVC Free
8T	265	287
8K	281	304

## **HTECB Communication Box**

The Communication Box can be affixed inside the Single or Double Module for HA Stage at the desired location.

### **WHAT'S INCLUDED**

1 communication box.

### **NOTES**

Has an opening of 2.71" x 1.38" (69 mm x 35 mm).

Finished in a Platinum Coordinate.

Voice/Data Faceplates, Jacks and Wire Management Clips must be field supplied and installed.



### **PRODUCT OPTIONS**

---

#### **Country of Installation**

A Canada/USA

### **SAMPLE ORDER CODE**

---

**HTECB A**

---

### **PRICING**

---

---

---

**HTEL**  
**Power Pole**

The Power Pole routes a Ceiling Feed and data cables from the ceiling into the workstation.

**WHAT'S INCLUDED**

1 power pole.

**NOTES**

Is used to route a ceiling feed and data cables from the ceiling into the beam in the center of the frame.

Available in 8',10' & 12' heights.

A Cut Out is available at desk height so that the cable can enter the bench at desk height.



**PRODUCT OPTIONS**

Cable Length	Finish	Mounting Option
<b>096</b> 096	Foundation	<b>1</b> Corner
<b>120</b> 120	Mica	
<b>144</b> 144	Accent	

**SAMPLE ORDER CODE**

<b>HTEL 144</b>	<b>52</b>	<b>1</b>
-----------------	-----------	----------

**DIMENSIONS**  
**INCHES / MM**

L
096 / 2438
120 / 3048
144 / 3658

**PRICING**

Foundation	Accent/Mica
963	991
991	1022
1110	1165

**H T E A**  
**Access Door for Multi-Circuit Desk**

The Access Door covers the Cut Out in the Access Power Cut Out Worksurface or Table.

**WHAT'S INCLUDED**  
1 access door.

**NOTES**  
Door available in different finishes.



**PRODUCT OPTIONS**

Finish for Door
Foundation
Mica
Accent

**SAMPLE ORDER CODE**

**HTEA 52**

**PRICING**

Foundation	Accent/Mica
216	238



The Rectangular Grommet can be field installed when cable management is needed.

**WHAT'S INCLUDED**

1 grommet.

**NOTES**

Rectangle Cut Outs can be specified as an option on selected worksurfaces or tables.

**H T E G**  
**Rectangle Grommet**



**PRODUCT OPTIONS**

Finish
Foundation
Mica
Accent

**SAMPLE ORDER CODE**

<b>HTEG 60</b>
----------------

**PRICING**

50
----

## HTEN Multi-Circuit Desk Housing

The Multi-Circuit Desk Housing is used under a Worksurface or Freestanding Table to provide a housing for the Multi-Circuit Desk Power Module (HTEM) sold separately.

### WHAT'S INCLUDED

1 multi-circuit desk housing, mounting hardware

### NOTES

To used with Multi-Circuit Desk Power Module (HTEM), Receptacle Outlet (HTERO) & Accessory Door for Multi-Circuit (HTEA). Each sold separately.

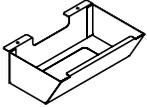

### PRODUCT OPTIONS

---

#### Finish

Foundation

Mica

Accent

### SAMPLE ORDER CODE

---

**HTEN 52**

---

### PRICING

---

Foundation	Accent/Mica
97	104

---

The I-Connector is used to join two harnesses when a single harness length is not long enough.

# HTEJIC I-Connector

**WHAT'S INCLUDED**

1 i-connector.



**PRODUCT OPTIONS**

**Country of Installation**

A Canada/USA

**SAMPLE ORDER CODE**

**HTEJIC A**

**PRICING**

54

## **HTEJDB** **Four-Way Splitter**

The Four-Way Splitter attaches to a harness to split power.

### **WHAT'S INCLUDED**

1 four-way splitter and hardware.

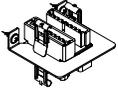

### **PRODUCT OPTIONS**

---

#### **Country of Installation**

A Canada/USA

### **SAMPLE ORDER CODE**

---

**HTEJDB A**

---

### **PRICING**

---

171

---

The Wire Clips can be screwed under the worksurface at the desired location to manage excess wires.

**WHAT'S INCLUDED**

1 package of 6 clips and mounting hardware.

**NOTES**

Available in Black only.

**H T E W**  
**Wire Clips**

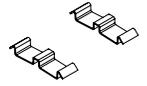

**PRICING**

---

53

---

**H T E T**

**Worksurface Cable Tray**

The Worksurface Cable Tray attaches to the underside of a worksurface to manage excess wires.

**WHAT'S INCLUDED**

1 cable tray and mounting hardware.

**NOTES**

Available in Black only.

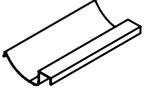

**PRICING**

---

30

---

---

The Receptacle Outlet mounts onto the Simple Stage Power Box to provide access to power.

**WHAT'S INCLUDED**

1 duplex.

**NOTES**

Specified individually for maximum circuit flexibility.

Two receptacles can be mounted to each of the Multi Circuit Desk Power or each side of the Power Module for HA Stage (HTEPM) or Simple Stage Power Box (HTEFS).

Styles include Standard 15 amp, T-Slot 20 amp, Controlled 15 and 20 amp.

Outlet configurations consist of Circuit 1, Circuit 2, Circuit 3 (use 7T and 8T only), Circuit 5 (8T and 8K only), Circuit 6 (use 8K only), Circuit A (7T and 7K only) and Circuit B (7K only). Receptacle color.

Receptacle style D and E include a marking indicating it is connected to a control system

# HTERO Receptacle Outlet



**PRODUCT OPTIONS**

Receptacle Style	Outlet Installation	Country of Installation	Receptacle Finish
<b>S</b> Standard 15 amp	<b>1</b> Circuit 1	<b>A</b> Canada/USA	<b>YN</b> Platinum Grey Coordinate
<b>T</b> T-Slot 20 amp	<b>2</b> Circuit 2		<b>YY</b> Ebony
<b>D</b> Controlled 15 amp	<b>3</b> Circuit 3 (use with 7T & 8T only)		<b>YF</b> Storm White
<b>E</b> Controlled 20 amp	<b>5</b> Circuit 5 (use with 8T & 8K only)		<b>YV</b> Very White Coordinate
	<b>6</b> Circuit 6 (use with 8K only)		
	<b>A</b> Circuit A Non Isolated Ground (use with 7T & 7K only)		
	<b>B</b> Circuit B Non Isolated Ground (use with 7K only)		

**SAMPLE ORDER CODE**

<b>HTERO S</b>	<b>6</b>	<b>A</b>	<b>YN</b>
----------------	----------	----------	-----------

**PRICING**

Style	
S	44
T	53
D	44
E	53

**HTEK**  
**Simple Stage Power Cover**

A blank plate to cover unused opening in power ports.

**WHAT'S INCLUDED**

1 blank plate.



**PRODUCT OPTIONS**

Metal Finish
Foundation
Mica
Accent

**SAMPLE ORDER CODE**

<b>HTEK 74</b>
----------------

**PRICING**

Foundation	Accent/Mica
52	58



The Data Extender Plate is placed over a communication opening to provide extended depth for data jack.

**WHAT'S INCLUDED**

1 data extender plate.

**NOTES**

Designed to provide extended depth for data jacks which may be required in some applications. Consult your data cabling supplier for clearance requirements.

**H T E E E**  
**Data Extender Plate**



**PRODUCT OPTIONS**

Finish	
YY	Ebony Coordinate
YF	Storm White
YN	Platinum Grey Coordinate
YV	Very White Coordinate

**SAMPLE ORDER CODE**

<b>HTEEE YF</b>
-----------------

**PRICING**

35
----

**H T E Z**  
**Simple Stage Data Cover**

A blank plate to cover unused opening in data ports.

**WHAT'S INCLUDED**

1 blank plate.



**PRODUCT OPTIONS**

---

**Finish**

- YY Ebony Coordinate
- YF Storm White Coordinate
- YN Platinum Grey Coordinate
- YV Very White Coordinate

**SAMPLE ORDER CODE**

---

**HTEZ YF**

---

**PRICING**

---

21

---

The Chicago Junction Box attaches to a harness to split power, up to two modules.

**WHAT'S INCLUDED**

1 junction box and mounting hardware.

**NOTES**

Brackets are finished in Platinum.

**H T E X**  
**Chicago Junction Box**



**PRODUCT OPTIONS**

**Country of Installation**

A Canada/USA

**SAMPLE ORDER CODE**

**HTEX A**

**PRICING**

151

**V E S**

**International Stage Mount Kit**

The International Stage Mount Kit permits mounting of the Power Logic VED Outlet Box.

**WHAT'S INCLUDED**

Mounting brackets, hardware.



**PRODUCT OPTIONS**

Number of Brackets	Number of Brackets
<b>V</b> For Power Logic <b>E</b> For CALA Bryne	<b>2</b> For Two Outlet Box <b>4</b> For Four Outlet Box

**SAMPLE ORDER CODE**

<b>VES E</b>	<b>2</b>
--------------	----------

**PRICING**

59
----

Power Conservation system provides an automatically turn off to items like task lights, monitors, personal heaters and fans and other non-essential user equipment when they are not in use.

**WHAT'S INCLUDED**

Power conservation system consists of a control box, selected number of sensors, system connection brackets, connecting cables and a four-way splitter

**NOTES**

Timer is set for 20 minutes for automatic shut-off after area is unoccupied. System sensors are available in Black only. Sensor connection wires are available in Grey and White only. System control box is available in Platinum (Foundation) only. Each Control Box offers two separate output jack for connection of Occupancy Sensors. The first output jack controls power to all receptacles on Teknion Circuit 1 and the second output jack controls power to all receptacles on Teknion Circuit 2. Each of the output jacks is labeled on the control box.

Do not specify receptacles for circuits 1 and 2 at the same workstation when using Power Conservation System.

Each occupancy sensor can only control one circuit.

**HTEPC  
Power Conservation System**

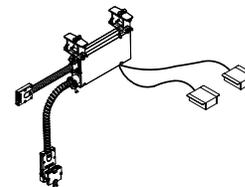

**PRODUCT OPTIONS**

Application	Stage Module Size	Number of Sensors
<b>D</b> Interior of Stage for Back to Back Installation	<b>SM</b> For Frame Modules 60" or less	<b>2</b> Two
	<b>LG</b> For Frame Modules 66" or more	<b>4</b> Four <b>8</b> Eight

**SAMPLE ORDER CODE**

<b>HTEPC D</b>	<b>LG</b>	<b>2</b>
----------------	-----------	----------

APPLICATION	PRICING		
	Two Sensors	Four Sensors	Eight Sensors
For Frame Module 60" of Less	1934	2380	3276
For Frame Module 60" of More	2168	2615	3512

**V B C U**

**CALA Power Module**

The CALA Power Modules provides one or two duplexes mounted to the Power Rail on one side of the Stage. It's location is user adjustable along the Power Rail.

**WHAT'S INCLUDED**

1 power module, mounting brackets and plastic face plate

**NOTES**

Power Module and Duplexes available in a Very White and Black finish.

Receptacle finish will automatically match the finish option selected.

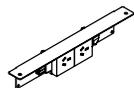

**PRODUCT OPTIONS**

Application	Outlet Configuration	Country of Installation	Length	Receptacle Finish
<b>DA</b> Double Duplex, One Sided	<b>200</b> Two Power	<b>R</b> Argentina <b>N</b> Brazil <b>L</b> Chile	120	<b>YY</b> Ebony Coordinate <b>YV</b> Very White
	<b>120</b> One Power & One USB			
<b>SA</b> Single Duplex, One Sided	<b>400</b> Four Power			
	<b>320</b> Three Power & One USB			

**SAMPLE ORDER CODE**

<b>VBCU DA</b>	<b>320</b>	<b>N</b>	<b>120</b>	<b>YY</b>
----------------	------------	----------	------------	-----------

APPLICATION	PRICING			
	Two Power (200)	One Power & One USB (120)	Four Power (400)	Three Power & One USB (320)
DA	n/a	n/a	935	1112
SA	665	841	n/a	n/a

The Jumper Power Harness routes power between CALA Power Modules in the stage that provide access areas and also carries power through the adjacent panel

**V B P H**

**CALA Jumper Power Harness**

**WHAT'S INCLUDED**

1 interconnecting power cable, 2000 mm in length



**PRODUCT OPTIONS**

Length
20 2000 mm

**SAMPLE ORDER CODE**

**VBPH 20**

**PRICING**

176
-----

**VBPU**  
**CALA Power In Feed**

The Power In feed cable brings power from the building to the upStage stage. It can be installed in the side of the stage to feed power to the CALA power module. It can also be brought down from the ceiling to the workstation.

**WHAT'S INCLUDED**

1 input power cable, 1800mm in length

**NOTES**

Country of Installation is required to determined correct source plug in option is chosen.

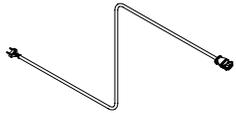

**PRODUCT OPTIONS**

Length	Country of Installation
<b>18</b> 1800 mm	<b>R</b> Argentina <b>N</b> Brazil <b>L</b> Chile

**SAMPLE ORDER CODE**

<b>VBPU</b>	<b>18</b>
-------------	-----------

**PRICING**

384



The CALA power station is designed to provide casual power/data at the worksurface level. It is designed to affixed to the edge of the worksurface.

**WHAT'S INCLUDED**

1 CALA power station, 1800mm in length. Fronts and sides are finished with selected finish. Rear and Desk Edge Clamp are in clear anodized only.

**NOTES**

Each power station will include an extension plate so that it can be outfitted to a knife edge trim surface Enclosure and Connection clamp is available in Clear Anodized Aluminum finish only.



**PRODUCT OPTIONS**

Numbers of Outlets	Outlet Configuration	Country of Installation	Cable Length	Receptacle Finish
<b>D</b> Double Outlet	<b>202</b> Two Power & Two Data	<b>R</b> Argentina	<b>18</b> 1800mm	<b>YY</b> Ebony Coordinate
	<b>400</b> Four Power	<b>N</b> Brazil		<b>YV</b> Very White Coordinate
	<b>320</b> Three Power & One USB	<b>L</b> Chile		

**SAMPLE ORDER CODE**

<b>VBWB D</b>	<b>320</b>	<b>N</b>	<b>18</b>	<b>YY</b>
---------------	------------	----------	-----------	-----------

**OUTLETS**

<b>D</b>
----------

**PRICING**

Two Power & Two Data (202)	Four Power (400)	Three Power & One USB (320)
822	1058	1252

# teknion

[www.teknion.com](http://www.teknion.com)

CAN/US/INT 01-27  
©Teknion 2025

®, ™ trade marks of Teknion Corporation  
and/or its subsidiaries or licensed to it.  
Patents may be pending.

Some products may not be available in  
all markets. Contact your local Teknion  
Representative for availability.

JAN25-UPS