

PROGRAM GUIDE

applications & pricing

01.22.2024

studio 



contents

Studio

Seating	17
Screens	305
Tables	313
Accessories	399
Technical	407
Finishes & Textiles	429

B&B Italia

Seating	449
AC Executive	459
Finishes & Textiles	475



summary

Studio PPG / B&B PPG

Please be advised that information has been updated within the Studio/B&B Price Guide. To highlight these updates a summary has been created for your reference.

NEW:

- New textiles have been added:
 - Textured Map (Gr. 3)
 - High Frequency (Gr. 4)
 - Soft Static (Gr. 6)
 - Super Shearling (Gr. 9)

REVISED:

- Additional information has been provided for power accessories with USB ports.

Please note, first orders for new products will be accepted on January 22, 2024. All software will also be updated by January 22, 2024. If you have any questions regarding the information enclosed, please contact your Teknion Customer Service Representative.

Studio TK offers a variety of seating, tables and screen collections.

Studio TK offers a variety of seating, tables and screen collections.

Studio TK offers a variety of seating, tables and screen collections.

Studio TK offers a variety of seating, tables and screen collections.

Studio TK offers a variety of seating, tables and screen collections.



seating

Adventura	18	Kalm	222
Africa	26	Kes	228
Beso	30	Kuskoa Bi.	230
Borough.	42	Kuskoa.	236
Cesto.	74	Lasai	240
Clip.	86	Libelle	244
Clique	92	Nina.	248
Cover.	164	Pala.	252
Delta	168	Petal	257
Dual	172	Pico.	262
F500 Series	180	Qui	268
Fractals.	184	Santé.	274
Havn	196	Trine	282
Infinito	204	Vettore.	288
Jima	216		

adventura

features

Adventura is a flexible lounge collection including a lounge chair, settee and sofa with a variety of options to fit in various workplace applications. Designed by the Studio TK Design team, Adventura brings in classic design details of European styles paired with Studio TK's flexible options to allow designers to select multiple fabrics, finishes and optional details. Inspired by a "choose your own adventure" selection of finishes and configurations makes this simple set of pieces very expansive for refined corporate spaces or crafted start-up environments.

The versatile lounge collection offers two leg styles, a four leg post or sled version, in either powdercoat paint or polished stainless steel. Additionally, a broader range of back cushion options including a no-tuft back, a sewn in tufted back or a button tufted back expands the options and applications for Adventura.

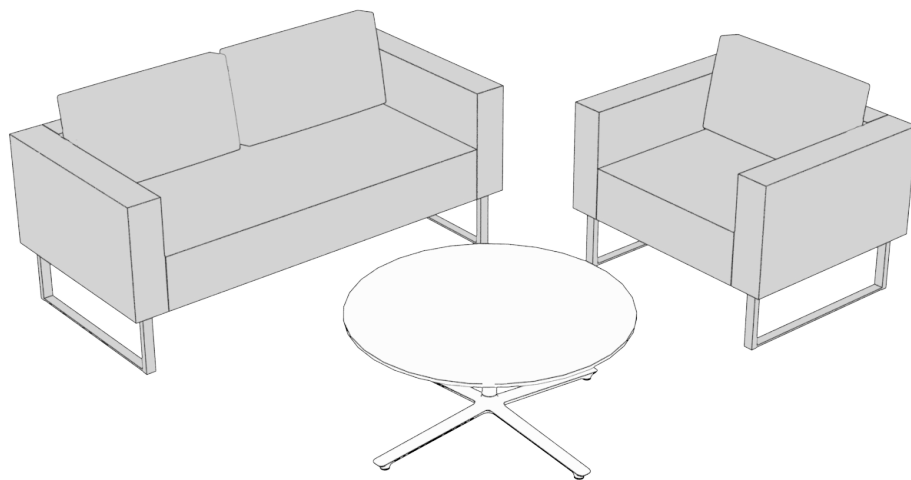

adventura

dimensions

- Designed and tested for users up to 300 lbs
- Meets ANSI/BIFMA requirements

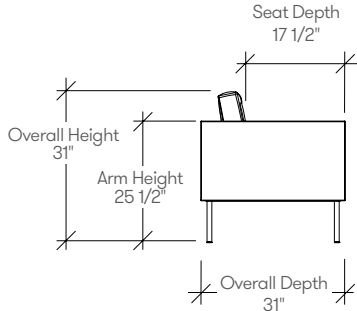

Adventura
side view

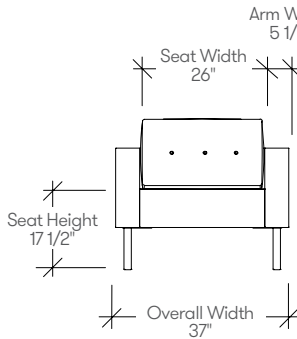

Adventura, Lounge
[STV1]
front view

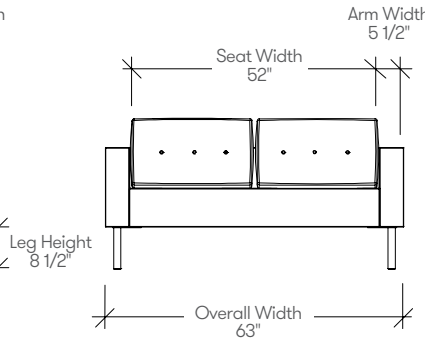

Adventura, Settee
[STV2]
front view

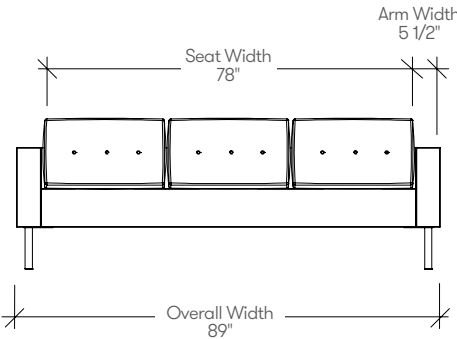

Adventura, Sofa
[STV3]
front view

additional dimensions

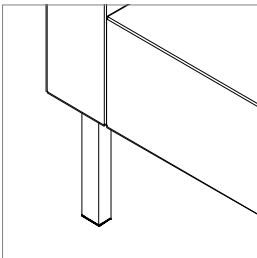

depth: 1"
width: 1 1/2"

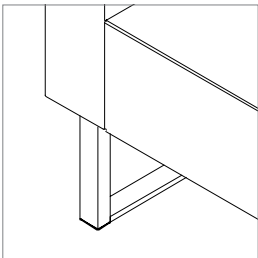

depth: 1"
width: 1 1/2"
sled base thickness: 3/8"

Sewn Tuft Width	6"
Distance between buttons on the buttons tuft	6 1/2"

adventura

planning

A variety of configurations can be achieved with Adventura, allowing for various configurations. The following typical demonstrate the versatility that can be achieved.

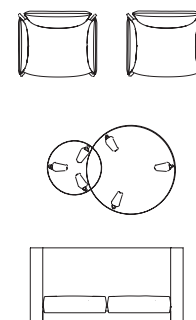
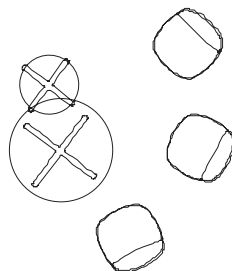
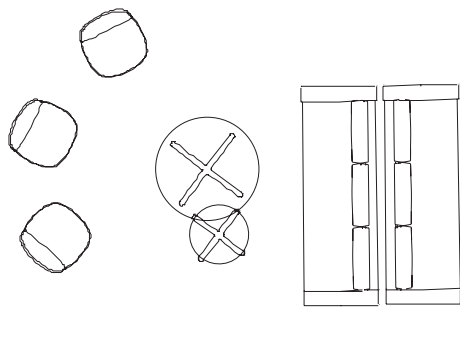
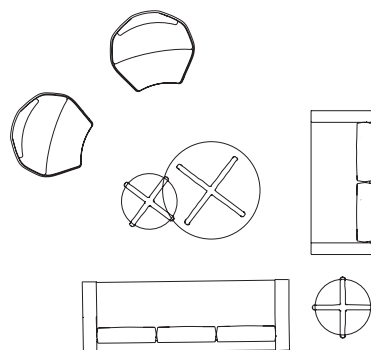
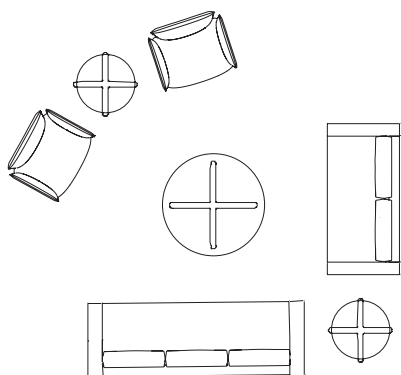
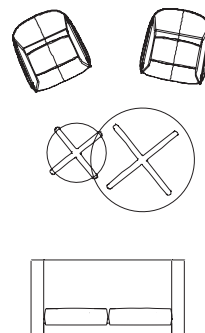
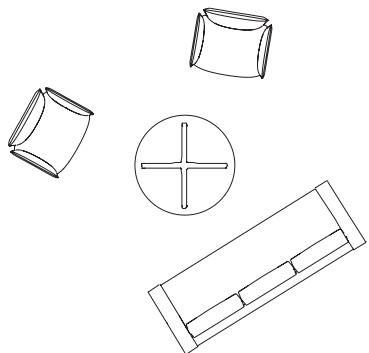

specifying aventura finishes

The modularity of Adventura permits a wide range of fabric combinations that allows for an expressive use of color, texture and material.

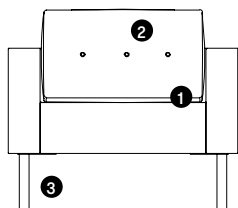

- 1 Seat and Arm Frame Upholstery**
Select the seat and arm upholstery
- 2 Back Cushion Upholstery**
Select the back cushion upholstery
- 3 Leg Finish**
Select leg finish

specification example

STVIW Adventura Lounge Chair, Post Leg	
1 Seat and Arm Frame Gr.2	2711
2 Back Cushion Gr.3	107
3 Fashion Paint Gr.2	29
Total:	\$2847

COM/COL material requirement

Yardage is based on a non-patterned fabric. Additional yardage may be required for pattern repeats and the matching required. Leather yield may be affected by the quality of the COL. However, variance in the size of the hides will not affect the yield.

SINGLE UPHOLSTERY		COM [yards]	COL [sq. ft.]
Adventura Lounge	Cushion	1 1/4	22 1/2
	Seat, Arm, Outer Back	6	108
Adventura Settee	Cushion	2 1/2	45
	Seat, Arm, Outer Back	8 1/2	153
Adventura Sofa	Cushion	3 3/4	67 1/2
	Seat, Arm, Outer Back	11	198

STV1 aventura lounge

Product Options

Arm Style	Back Cushion Style	Leg Style	Frame Upholstery	Back Cushion Upholstery	Leg Finish
N No Wrap	N No Tuft S Sewn Tuft B Button Tuft	L Four Leg U Sled Base	Fabric Leather	Fabric Leather	S1 Stainless Steel Fundamental Paint Fashion Paint

Note For No Tuft, add \$0
 For Sewn Tuft, add \$0
 For Button Tuft, add \$0
 For Fundamental Paint, add \$0
 For Fashion Paint, add \$29
 For Polished Stainless Steel, add \$406

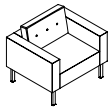

		Seat													
		COM	COL	Gr.1	Gr.2	Gr.3	Gr.4	Gr.5	Gr.6	Gr.7	Gr.8	Gr.9	Gr.10	Gr.11	
N No Wrap N No Tuft	L Four Leg	2187	2318	2465	2589	2697	2821	2914	2990	3068	3161	3254	3347	3454	
	U Sled Base	2308	2448	2587	2711	2819	2943	3036	3112	3190	3283	3376	3468	3576	
												Leather			
				Gr.12	Gr.13	Gr.14	Gr.15	Gr.16	Gr.17	Gr.18	Gr.19	Gr.20	LB	LC	LD
N No Wrap N No Tuft	L Four Leg	3579	3733	3888	4043	4197	4352	4507	4661	4816			3988	4823	5102
	U Sled Base	3700	3855	4010	4164	4319	4474	4628	4783	4938			4118	4953	5232
		Back													
		COM	COL	Gr.1	Gr.2	Gr.3	Gr.4	Gr.5	Gr.6	Gr.7	Gr.8	Gr.9	Gr.10	Gr.11	
N No Wrap N No Tuft	L Four Leg	0	116	58	84	107	132	152	167	183	203	223	241	264	
	U Sled Base	0	116	58	84	107	132	152	167	183	203	223	241	264	
													Leather		
				Gr.12	Gr.13	Gr.14	Gr.15	Gr.16	Gr.17	Gr.18	Gr.19	Gr.20	LB	LC	LD
N No Wrap N No Tuft	L Four Leg	290	322	355	386	419	451	484	515	548			348	522	580
	U Sled Base	290	322	355	386	419	451	484	515	548			348	522	580

STV2 aventura settee

Product Options

Arm Style	Back Cushion Style	Leg Style	Frame Upholstery	Back Cushion Upholstery	Leg Finish
N No Wrap	N No Tuft S Sewn Tuft B Button Tuft	L Four Leg U Sled Base	Fabric Leather	Fabric Leather	S1 Stainless Steel Fundamental Paint Fashion Paint

Note For No Tuft, add \$0
 For Sewn Tuft, add \$0
 For Button Tuft, add \$0
 For Fundamental Paint, add \$0
 For Fashion Paint, add \$29
 For Polished Stainless Steel, add \$406

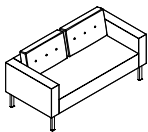

		Seat															
		COM	COL	Gr.1	Gr.2	Gr.3	Gr.4	Gr.5	Gr.6	Gr.7	Gr.8	Gr.9	Gr.10	Gr.11			
N No Wrap N No Tuft	L Four Leg	3405	3609	3799	3974	4127	4302	4435	4544	4654	4785	4916	5048	5201			
	U Sled Base	3526	3739	3921	4096	4249	4424	4556	4666	4776	4907	5038	5170	5323			
															Leather		
															LB	LC	LD
N No Wrap N No Tuft	L Four Leg	5377	5596	5815	6034	6254	6472	6691	6910	7129		5975	7158	7553			
	U Sled Base	5498	5718	5937	6156	6375	6593	6813	7032	7251		6105	7288	7683			
															Leather		
															LB	LC	LD
N No Wrap N No Tuft	L Four Leg	0	116	116	167	212	264	303	335	368	406	444	484	529			
	U Sled Base	0	116	116	167	212	264	303	335	368	406	444	484	529			
															Leather		
															LB	LC	LD
N No Wrap N No Tuft	L Four Leg	580	645	709	774	838	902	966	1031	1095		696	1044	1160			
	U Sled Base	580	645	709	774	838	902	966	1031	1095		696	1044	1160			
															Leather		
															LB	LC	LD

STV3 aventura sofa

Product Options

Arm Style	Back Cushion Style	Leg Style	Frame Upholstery	Back Cushion Upholstery	Leg Finish
N No Wrap	N No Tuft S Sewn Tuft B Button Tuft	L Four Leg U Sled Base	Fabric Leather	Fabric Leather	S1 Stainless Steel Fundamental Paint Fashion Paint

Note For No Tuft, add \$0
 For Sewn Tuft, add \$0
 For Button Tuft, add \$0
 For Fundamental Paint, add \$0
 For Fashion Paint, add \$29
 For Polished Stainless Steel, add \$406

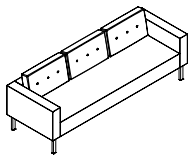

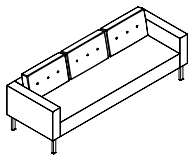
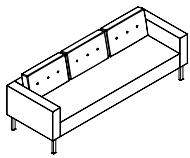
		Seat												
		COM	COL	Gr.1	Gr.2	Gr.3	Gr.4	Gr.5	Gr.6	Gr.7	Gr.8	Gr.9	Gr.10	Gr.11
 N No Wrap N No Tuft L Four Leg U Sled Base	N No Wrap N No Tuft	4135	4384	4646	4873	5072	5298	5468	5610	5751	5922	6092	6262	6460
	L Four Leg	4257	4514	4768	4995	5193	5420	5590	5732	5873	6044	6214	6383	6582
	U Sled Base													
		Gr.12	Gr.13	Gr.14	Gr.15	Gr.16	Gr.17	Gr.18	Gr.19	Gr.20	Leather			
											LB	LC	LD	
N No Wrap N No Tuft L Four Leg U Sled Base	N No Wrap N No Tuft	6687	6970	7255	7538	7822	8105	8389	8672	8956		7446	8977	9488
	L Four Leg	6809	7092	7376	7659	7944	8227	8511	8794	9078		7576	9107	9618
	U Sled Base													
		Back												
		COM	COL	Gr.1	Gr.2	Gr.3	Gr.4	Gr.5	Gr.6	Gr.7	Gr.8	Gr.9	Gr.10	Gr.11
 N No Wrap N No Tuft L Four Leg U Sled Base	N No Wrap N No Tuft	0	116	174	252	319	397	455	502	551	609	667	725	792
	L Four Leg	0	116	174	252	319	397	455	502	551	609	667	725	792
	U Sled Base													
		Gr.12	Gr.13	Gr.14	Gr.15	Gr.16	Gr.17	Gr.18	Gr.19	Gr.20	Leather			
											LB	LC	LD	
N No Wrap N No Tuft L Four Leg U Sled Base	N No Wrap N No Tuft	870	966	1064	1160	1256	1354	1450	1546	1644		1044	1566	1740
	L Four Leg	870	966	1064	1160	1256	1354	1450	1546	1644		1044	1566	1740
	U Sled Base													

africa

features

In partnership with Vondom – a leading Spanish provider of furniture for modern indoor and outdoor commercial spaces – Studio TK is offering Africa seating in North America.

The Africa collection includes a chair, armchair and bar stool. The essence of this collection is reflected in its simple and natural forms. As the Africa collection’s designer, Eugeni Quitllet, says: “The most simple things are the most original... The most original thing is to be simple...”

Africa chairs is made of injected polypropylene with fiberglass. Chairs and stools are stackable and available in several colors.



dimensions

- Designed and tested for users up to 300 lbs
- Meets ANSI/BIFMA requirements

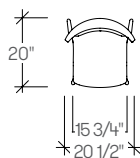

Africa Chair, Armless
(VMAFA)

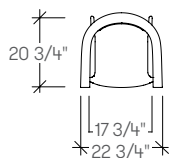

Africa Chair, Armchair
(VMAFB)

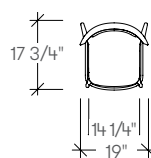

Africa Chair, Barstool
(VMAFC)

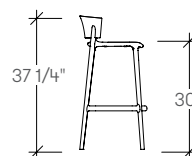
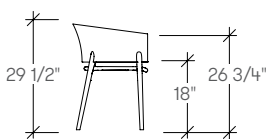
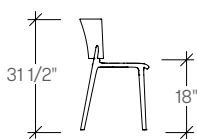

africa

planning

A variety of configurations can be achieved with Africa, allowing for various configurations. The following typical demonstrate the versatility that can be achieved.

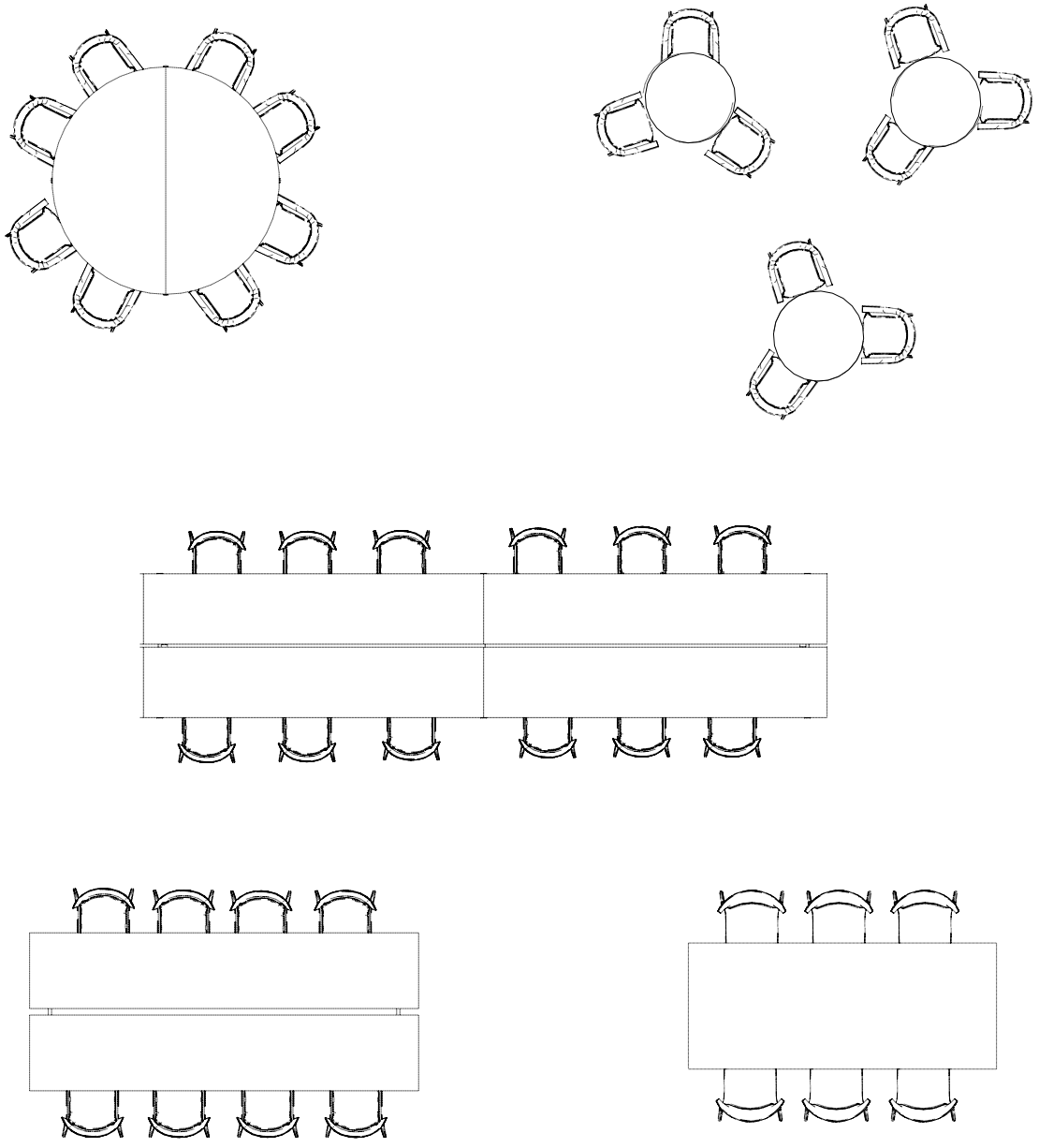

weights

Africa Chair, Armless	8 - 10 lbs
Africa Chair, Armchair	8 - 10 lbs
Africa Chair, Bar Stool	10 - 12 lbs

VMAFA africa chair, armless

Product Options

Vondom Plastic

- C1 White
- C2 Ecrú
- C3 Black

Note Chairs stack six units high
Weight of chair is 9 lbs.



Price
307

VMAFB africa chair, armchair

Product Options

Vondom Plastic

- C1 White
- C2 Ecrú
- C3 Black

Note Chairs stack six units high
Weight of chair is 9 lbs.



Price
394

VMAFC africa chair, barstool

Product Options

Vondom Plastic

- C1 White
- C2 Ecrú
- C3 Black

Note Chairs stack six units high
Weight of chair is 9 lbs.

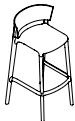

Price
371

beso by Artifort

features

Beso, spanish for 'kiss', is a versatile and stylish chair program created by Dutch designer Khodi Feiz. Beso collection includes variations of guest chairs, lounge chairs and stools. The juxtaposition between powerful and simplistic in the Beso design allows for a comprehensive seating program that can be placed in a large array of applications. Beso allows for long comfortable work with others, without the need to take a break or stretch your legs.



dimensions

- Designed and tested for users up to 110kg/242 lbs
- Meets standard European NEN-16139 requirements

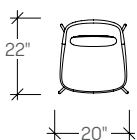

Beso Chair, Four Leg
(ARBC)

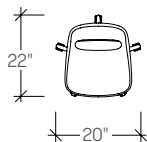

Beso Chair,
Five-Star Task
(ARBE)



Beso Chair,
Sled Base
(ARBA)



Beso Chair,
Wire Star Base
(ARBB)

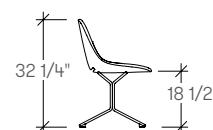
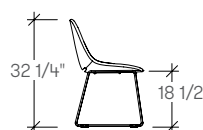
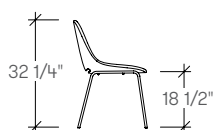

beso by Artifort

dimensions

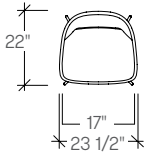

Beso Armchair,
Four Leg
(ARBG)

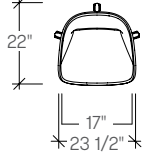

Beso Armchair,
Five-Star Task
(ARBJ)

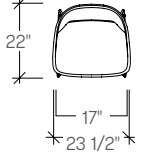

Beso Armchair,
Sled Base
(ARBF)

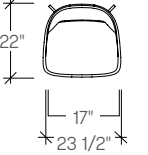

Beso Armchair,
Four-Star Wire Base
(ARBK)

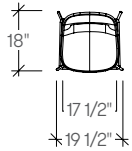
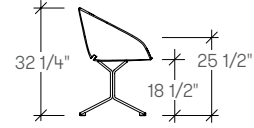
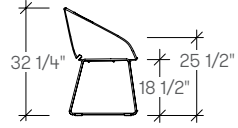
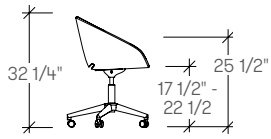
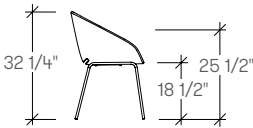

Beso Barstool, Four Leg
(ARBM)

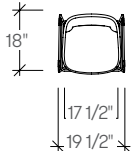

Beso Barstool, Sled
(ARBN)

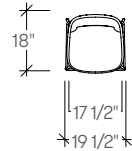

Beso Counter stool,
Four-leg
(ARBP)

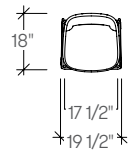

Beso Counter stool, Sled
(ARBQ)

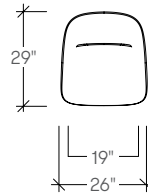
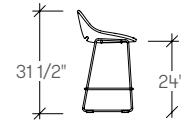
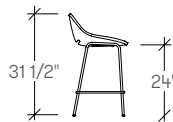
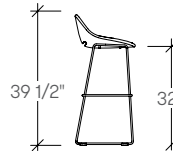
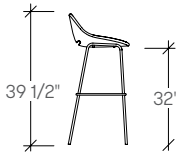

Beso Lounge Chair,
Four-Star Swivel
(ARBT)

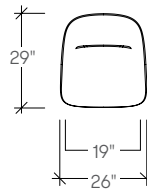

Beso Lounge Chair,
Wood Four Leg
(ARBW)

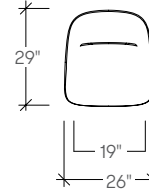

Beso Lounge Chair,
Wire Star Base
(ARBU)

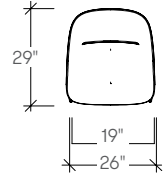

Beso Lounge Chair,
Sled Base
(ARBV)

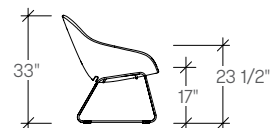
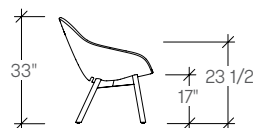

beso by Artifort

planning

A variety of configurations can be achieved with Beso, allowing for various configurations. The following typical demonstrate the versatility that can be achieved.

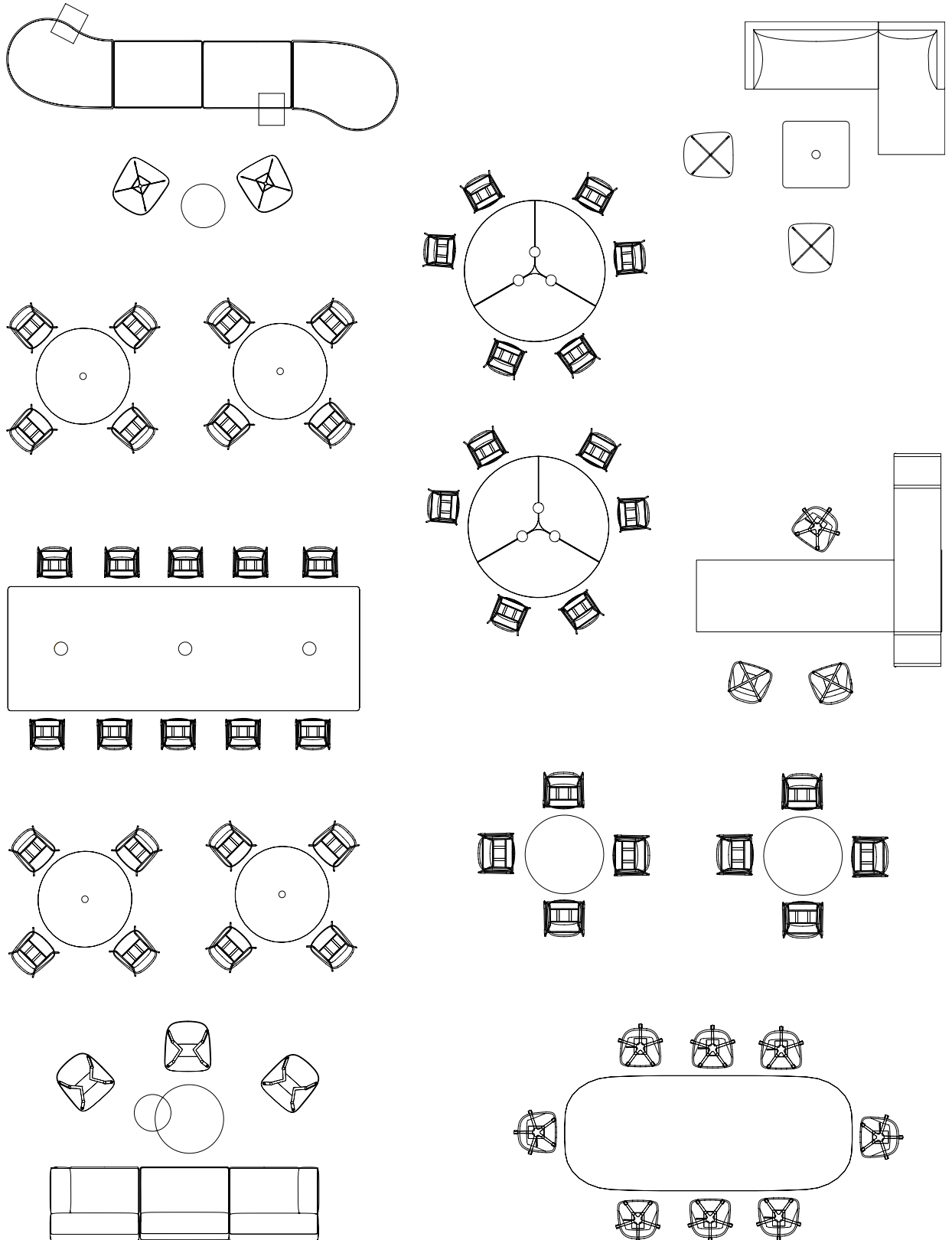

specifying beso finishes

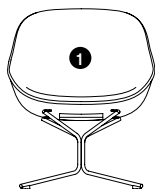

- 1 Seat Upholstery**
Select the seat upholstery

specification example

ARBU Beso Lounge Chair, Wire Star Base	
1 Seat fabric Gr.2	2069
Total:	\$2069

ARBU Beso Lounge Chair, Wire Star Base	
1 Seat fabric Gr.8	2404
Total:	\$2404

ARBW Beso Lounge Chair, Wood Leg	
1 Seat fabric Gr.2	2727
Total:	\$2727

ARBW Beso Lounge Chair, Wood Leg	
1 Seat fabric Gr.8	3061
Total:	\$3061

weights

Beso Chair, Four-Leg	18 - 23 lbs
Beso Chair, Five-Star Task	28 - 33 lbs
Beso Chair, Sled Base	20 - 25 lbs
Beso Chair, Wire Star Base	22 - 27 lbs
Beso Armchair, Four-Leg	20 - 25 lbs
Beso Armchair, Five-Star Task	30 - 35 lbs
Beso Armchair, Sled Base	23 - 28 lbs
Beso Armchair, Four-Star Wire Base	24 - 29 lbs
Beso Barstool, Four-Leg	19 - 24 lbs
Beso Barstool, Sled	20 - 25 lbs
Beso Counter Stool, Four-leg	18 - 23 lbs
Beso Counter Stool, Sled	19 - 24 lbs
Beso Lounge Chair, Wire Star Base	34 - 39 lbs
Beso Lounge Chair, Wood Leg	30 - 35 lbs
Beso Lounge Chair, Four-Star Swivel	37 - 42 lbs
Beso Lounge Chair, Sled Base	30 - 35 lbs

COM/COL material requirement

Yardage is based on a non-patterned fabric. Additional yardage may be required for pattern repeats and the matching required. Leather yield may be affected by the quality of the COL. However, variance in the size of the hides will not affect the yield.

SINGLE UPHOLSTERY

	COM [yards]	COL [sq. ft.]
Beso Chair	2	36
Beso Armchair	2 1/2	45
Beso Stool	1 3/4	31 1/2
Beso Lounge	3 1/2	63

ARBA **beso chair, sled base**

Product Options

Seat Upholstery Finish	Glides	Base Finish
Fabric	G Glides, No Felt	C6 Chrome
Leather	F Felt Glides	Fundamental Paint
		Fashion Paint

Note For Felt Glides, add \$35
 For Chrome, add \$0
 For Fundamental Paint Finish, add \$64
 For Fashion Paint Finish, add \$87



Price												
COM	COL	Gr.1	Gr.2	Gr.3	Gr.4	Gr.5	Gr.6	Gr.7	Gr.8	Gr.9	Gr.10	Gr.11
1370	1515	1463	1505	1540	1581	1612	1638	1663	1695	1726	1756	1792
Gr.12	Gr.13	Gr.14	Gr.15	Gr.16	Gr.17	Gr.18	Gr.19	Gr.20	Leather			
1834	1885	1937	1988	2040	2091	2144	2195	2247	LB	LC	LD	
									2072	2350	2443	

ARB B **beso chair, wire star base**

Product Options

Seat Upholstery Finish	Glides	Base Finish
Fabric	G Glides, No Felt	Fundamental Paint
Leather	F Felt Glides	Fashion Paint

Note For Felt Glides, add \$35
 For Fundamental Paint Finish, add \$0
 For Fashion Paint Finish, add \$29



Price												
COM	COL	Gr.1	Gr.2	Gr.3	Gr.4	Gr.5	Gr.6	Gr.7	Gr.8	Gr.9	Gr.10	Gr.11
1456	1601	1549	1590	1626	1667	1698	1724	1749	1781	1812	1842	1878
Gr.12	Gr.13	Gr.14	Gr.15	Gr.16	Gr.17	Gr.18	Gr.19	Gr.20	Leather			
1920	1971	2023	2074	2126	2177	2230	2281	2333	LB	LC	LD	
									2158	2436	2529	

ARBG beso armchair, four-leg

Product Options

Seat Upholstery Finish	Glides	Base Finish
Fabric	G Glides, No Felt	C6 Chrome
Leather	F Felt Glides	Fundamental Paint
		Fashion Paint

Note For Felt Glides, add \$35
 For Chrome, add \$0
 For Fundamental Paint, add \$64
 For Fashion Paint, add \$87



Price

COM	COL	Gr.1	Gr.2	Gr.3	Gr.4	Gr.5	Gr.6	Gr.7	Gr.8	Gr.9	Gr.10	Gr.11
1310	1455	1426	1477	1522	1574	1612	1645	1677	1716	1754	1793	1839
Gr.12	Gr.13	Gr.14	Gr.15	Gr.16	Gr.17	Gr.18	Gr.19	Gr.20	Leather			
1890	1955	2018	2083	2147	2212	2276	2341	2405	LB	LC	LD	
									2151	2499	2615	

ARBJ beso armchair, five-star task

Product Options

Seat Upholstery Finish	Base Finish
Fabric	C9 Polished Aluminum
Leather	



Price

COM	COL	Gr.1	Gr.2	Gr.3	Gr.4	Gr.5	Gr.6	Gr.7	Gr.8	Gr.9	Gr.10	Gr.11
1611	1756	1727	1778	1824	1876	1914	1946	1979	2017	2056	2095	2140
Gr.12	Gr.13	Gr.14	Gr.15	Gr.16	Gr.17	Gr.18	Gr.19	Gr.20	Leather			
2191	2256	2320	2385	2449	2514	2578	2642	2706	LB	LC	LD	
									2452	2800	2916	

ARBF **beso armchair, sled base**

Product Options

Seat Upholstery Finish	Glides	Base Finish
Fabric	G Glides, No Felt	C6 Chrome
Leather	F Felt Glides	Fundamental Paint
		Fashion Paint

Note For Felt Glides, add \$35
 For Chrome, add \$0
 For Fundamental Paint Finish, add \$64
 For Fashion Paint Finish, add \$87



Price												
COM	COL	Gr.1	Gr.2	Gr.3	Gr.4	Gr.5	Gr.6	Gr.7	Gr.8	Gr.9	Gr.10	Gr.11
1431	1576	1547	1598	1644	1696	1734	1767	1799	1837	1876	1915	1960
Gr.12	Gr.13	Gr.14	Gr.15	Gr.16	Gr.17	Gr.18	Gr.19	Gr.20	Leather			
2011	2076	2140	2205	2269	2334	2398	2463	2526	LB	LC	LD	
									2272	2620	2736	

ARBK **beso armchair, Four-Star wire base**

Product Options

Seat Upholstery Finish	Glides	Base Finish
Fabric	G Glides, No Felt	Fundamental Paint
Leather	F Felt Glides	Fashion Paint

Note For Felt Glides, add \$35
 For Fundamental Paint Finish, add \$0
 For Fashion Paint Finish, add \$29



Price												
COM	COL	Gr.1	Gr.2	Gr.3	Gr.4	Gr.5	Gr.6	Gr.7	Gr.8	Gr.9	Gr.10	Gr.11
1505	1650	1621	1672	1717	1769	1807	1840	1872	1911	1949	1988	2033
Gr.12	Gr.13	Gr.14	Gr.15	Gr.16	Gr.17	Gr.18	Gr.19	Gr.20	Leather			
2085	2149	2213	2278	2342	2407	2471	2536	2600	LB	LC	LD	
									2346	2694	2810	

ARBT **beso lounge chair, four-star swivel**

Product Options

Seat Upholstery Finish	Glides	Base Finish
Fabric	G Glides, No Felt	S1 Stainless Steel
Leather	F Felt Glides	

Note Four-star base includes auto-return to center swivel mechanism.
For Felt Glides, add \$35



Price												
COM	COL	Gr.1	Gr.2	Gr.3	Gr.4	Gr.5	Gr.6	Gr.7	Gr.8	Gr.9	Gr.10	Gr.11
2625	2770	2787	2859	2923	2995	3050	3094	3139	3193	3248	3301	3365
										Leather		
Gr.12	Gr.13	Gr.14	Gr.15	Gr.16	Gr.17	Gr.18	Gr.19	Gr.20	LB	LC	LD	
3437	3528	3618	3707	3798	3888	3979	4068	4159	3744	4232	4394	

ARBV **beso lounge chair, sled base**

Product Options

Seat Upholstery Finish	Glides	Base Finish
Fabric	G Glides, No Felt	C6 Chrome
Leather	F Felt Glides	Fundamental Paint
		Fashion Paint

Note For Felt Glides, add \$35
For Chrome, add \$0
For Fundamental Paint Finish, add \$64
For Fashion Paint Finish, add \$87



Price												
COM	COL	Gr.1	Gr.2	Gr.3	Gr.4	Gr.5	Gr.6	Gr.7	Gr.8	Gr.9	Gr.10	Gr.11
1943	2088	2105	2177	2241	2313	2368	2412	2457	2511	2566	2619	2683
										Leather		
Gr.12	Gr.13	Gr.14	Gr.15	Gr.16	Gr.17	Gr.18	Gr.19	Gr.20	LB	LC	LD	
2755	2845	2936	3025	3116	3206	3297	3386	3477	3062	3550	3712	

borough

features

Hospitable by nature, elegant by design, the modular lounge collection introduces a casual sophistication to any social setting. Borough lounge raises the bar of modular seating by combining home seating elements with the modular flexibility necessary for today's workplace. The application options of Borough are endless. The broad array of individual modular pieces expands the possibility of adaptation when planning spaces not only today but well into the future. As the needs of a workplace change, the Borough Lounge can adapt to fill those needs because of its compatible sectional geometry. The uses can be as simple as a single seat banquette to a room-filling back-to-back serpentine. Borough's modular system brings elegance, comfort, versatility, and functionality to any office environment.

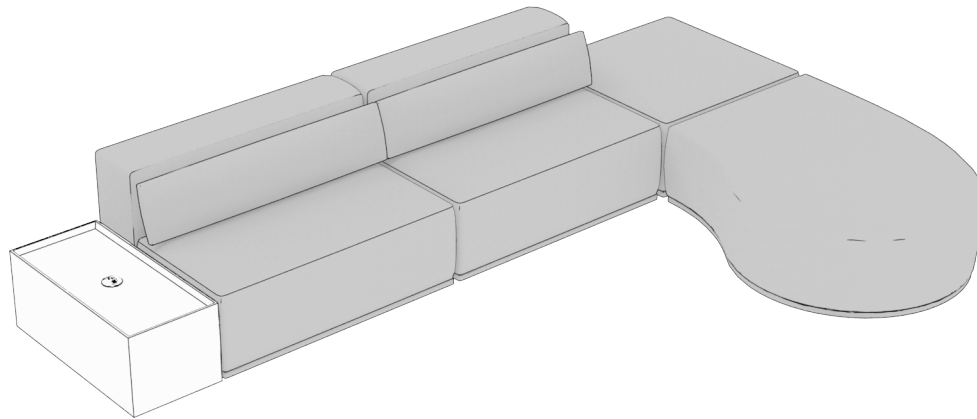

dimensions

- Designed and tested for users up to 300 lbs
- Meets ANSI/BIFMA requirements

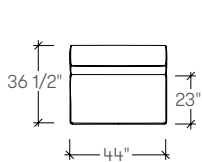

Borough Single Seat,
Angled Back
(STHA)

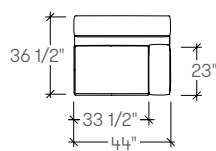

Borough Single Seat,
Arm Right Facing,
Angled Back
(STHE)

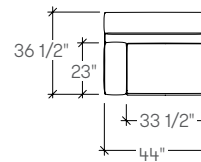

Borough Single Seat,
Arm Left Facing,
Angled Back
(STHF)

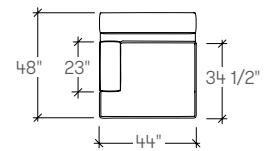

Borough Chaise,
Arm Left Facing,
Angled Back
(STHH)

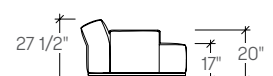
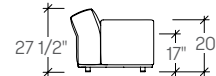
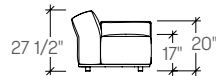

borough

dimensions (continued)

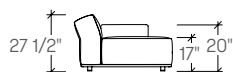
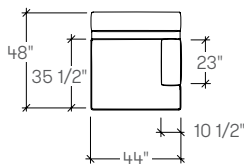

Borough Chaise,
Arm Right Facing,
Angled Back
(STHG)

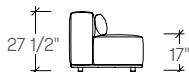
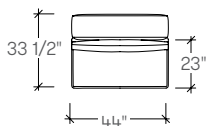

Borough Single Seat,
Straight Back
(STHB)

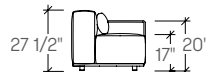
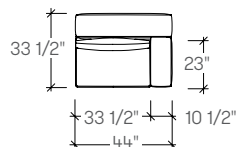

Borough Single Seat,
Arm Right Facing,
Straight Back
(STHC)

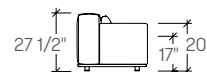
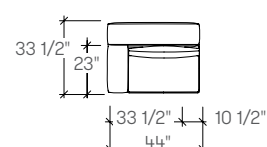

Borough Single Seat,
Arm Left Facing,
Straight Back
(STHD)

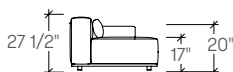
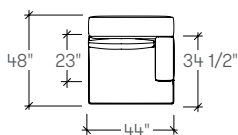

Borough Chaise,
Arm Right Facing,
Straight Back
(STHJ)

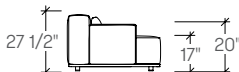
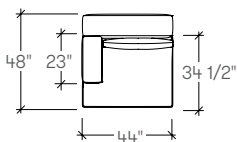

Borough Chaise,
Arm Left Facing,
Straight Back
(STHK)

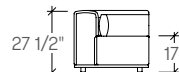
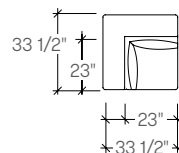

Borough Single Seat,
90 Corner,
Straight Back
(STHL)

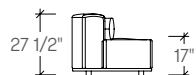
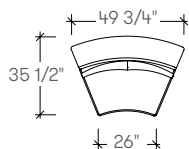

Borough Single Seat,
45 Inside Curve,
Straight Back
(STHW)

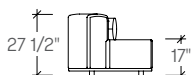
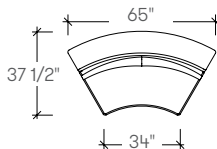

Borough Single Seat,
60 Inside Curve,
Straight Back
(STHX)

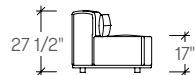
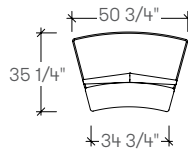

Borough Single Seat,
30 Outside Curve,
Straight Back
(STHY)

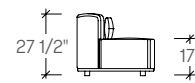
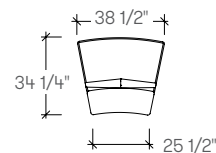

Borough Single Seat,
22.5 Outside Curve,
Straight Back
(STHZ)

borough

dimensions (continued)

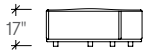
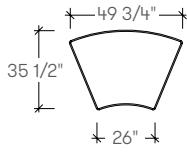

Borough Bench,
45 Inside Curve
(STHS)

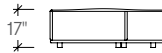
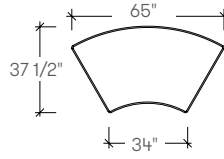

Borough Bench,
60 Inside Curve,
(STHT)

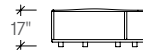
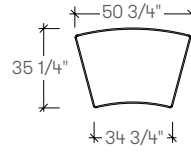

Borough Bench,
30 Outside Curve
(STHU)

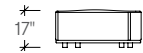
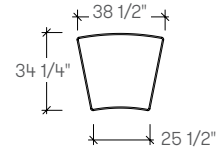

Borough Bench,
22.5 Outside Curve
(STHV)

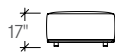
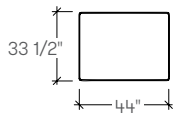

Borough Bench,
Rectangle
(STHM)

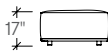
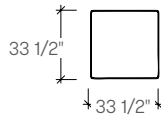

Borough Bench,
Square
(STHN)

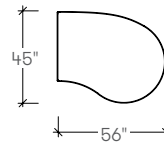

Borough Rounded
Bench,
Right Facing
(STHR)

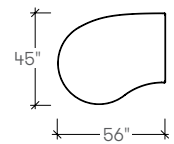

Borough Rounded
Bench,
Left Facing
(STHQ)

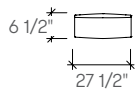

Borough Pillow,
Large Rectangular
(STHPA)

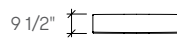
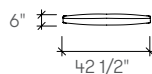

Borough Pillow,
Lumbar Long
(STHPB)

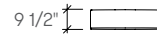
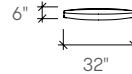

Borough Pillow,
Lumbar Short
(STHPC)

borough

planning

A variety of configurations can be achieved with Borough, allowing for various configurations. The following typical demonstrate the versatility that can be achieved.

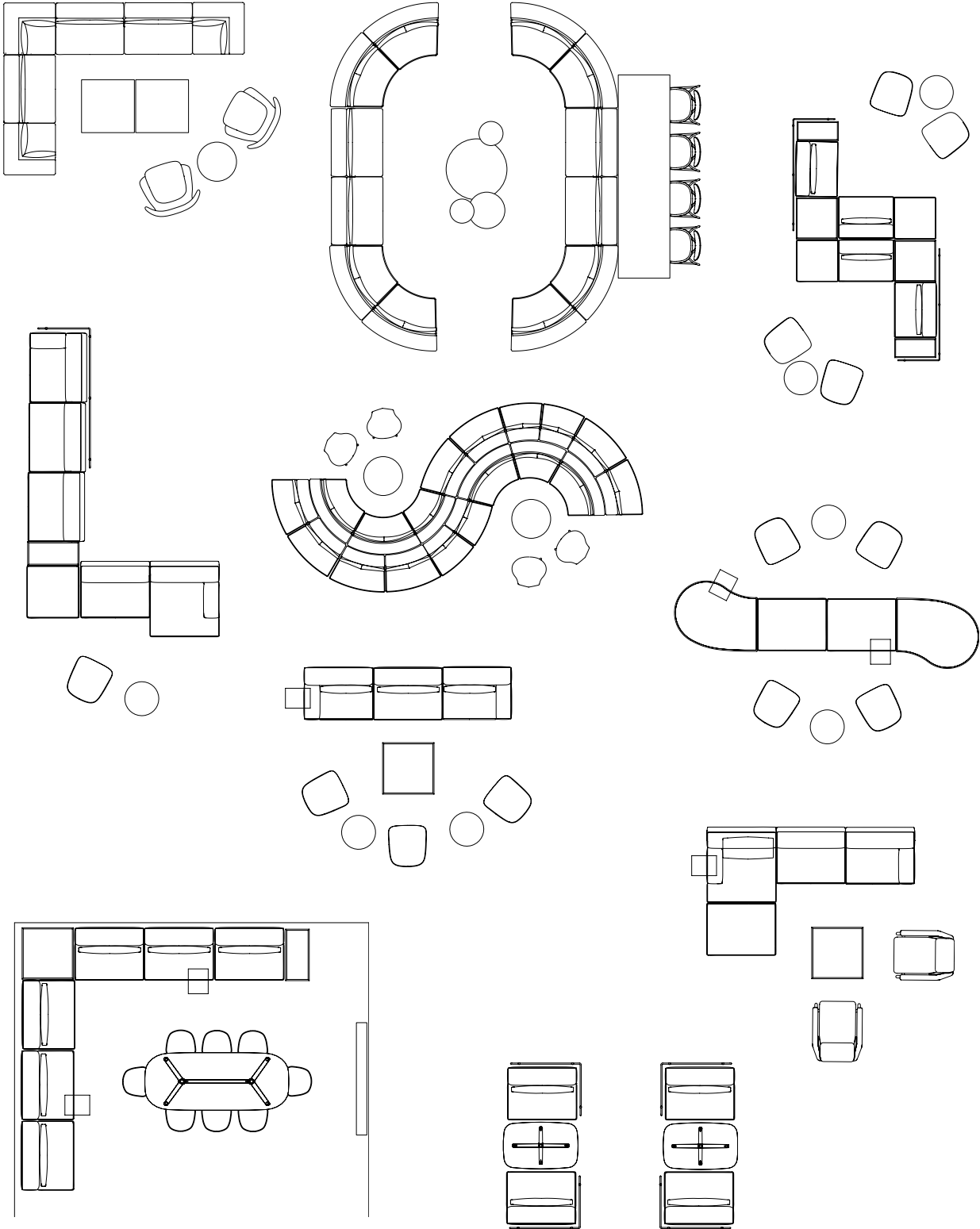

borough

details

The curved modular pieces are designed to form a double serpentine or be placed back to back.

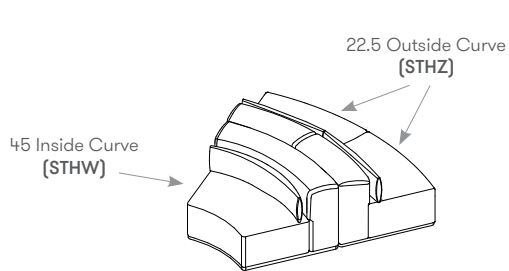
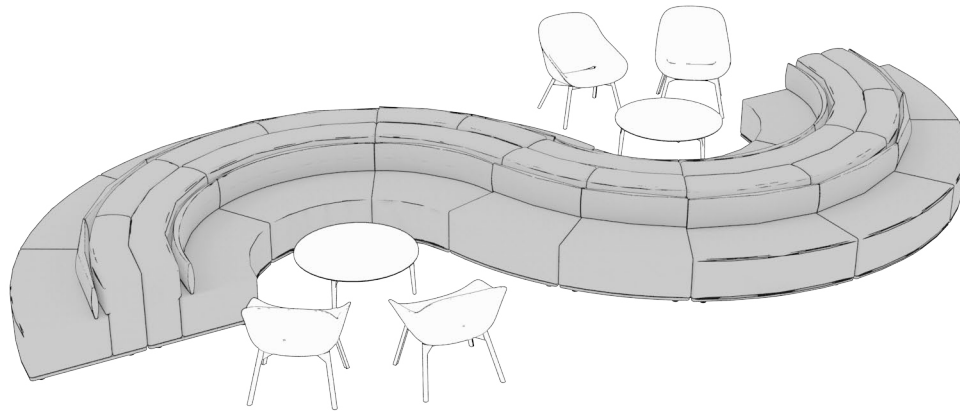

Two 22.5 Outside Curve units pair with one 45 Inside Curve Unit

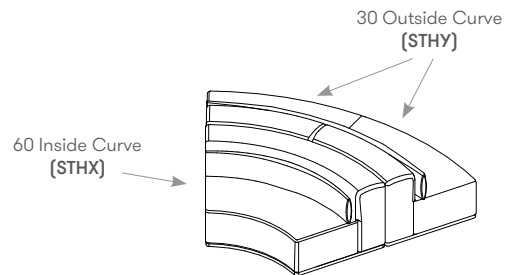

Two 30 Outside Curve units pair with one 60 Inside Curve Unit

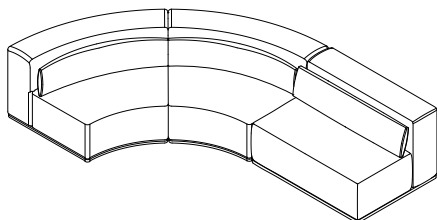

Two 45 units can be ganged to create a curved 90

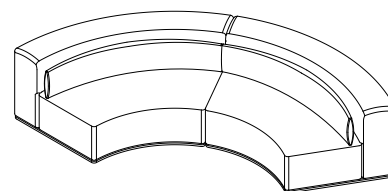

Two 60 Units can be ganged to create a curved 120

note on finishes

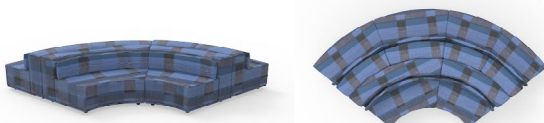

Studio TK does not recommend using patterned or striped textiles on the Borough Lounge. These textiles will become askew during the fabrication process, which causes distortions to the pattern or stripes, deviations to the pattern or stripe across the entire piece of furniture, and pattern or stripe misalignments from sectional to sectional. For these reasons, Studio TK will not accept warranty claims for pattern matching distortions, deviations or misalignments when patterned or striped textiles are applied to the Borough Lounge.

specifying borough finishes

The modularity of Borough permits a wide range of fabric combinations that allows for an expressive use of color, texture and material.

Note:

Studio TK does not recommend using patterned or striped textiles on the Borough Lounge. These textiles will become askew during the fabrication process, which causes distortions to the pattern or stripes, deviations to the pattern or stripe across the entire piece of furniture, and pattern or stripe misalignments from sectional to sectional. For these reasons, Studio TK will not accept warranty claims for pattern matching distortions, deviations or misalignments when patterned or striped textiles are applied to the Borough Lounge.

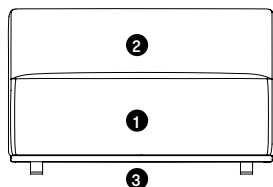

- 1 Seat Upholstery**
Select the seat upholstery
- 2 Back Upholstery**
Select the back upholstery
- 3 Base Finish**
Select fabric

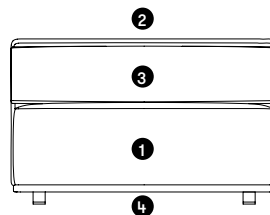

- 1 Seat Upholstery**
Select the seat upholstery
- 2 Back Upholstery**
Select the back upholstery
- 3 Lumbar Pillow Upholstery**
Select the lumbar pillow upholstery
- 4 Base Finish**
Select fabric

specification example

STHAU Borough Single Seat, Angled Back, Upholstered Base		
1	Seat fabric Gr.5	2433
2	Back fabric Gr.5	485
3	Base fabric Gr.5	242
Total:		\$3160

STHAU Borough Single Seat, Angled Back, Upholstered Base		
1	Seat fabric Gr.5	2433
2	Back fabric Gr.3	340
3	Base fabric Gr.5	242
Total:		\$3015

STHAU Borough Single Seat, Angled Back, Upholstered Base		
1	Seat fabric Gr.5	2433
2	Back fabric Gr.9	711
3	Base fabric Gr.5	242
Total:		\$3386

STHBU Borough Single Seat, Straight Back, Upholstered Back		
1	Seat fabric Gr.5	2433
2	Back fabric Gr.5	485
3	Lumbar fabric Gr.5	242
4	Base fabric Gr.5	242
Total:		\$3402

STHBU Borough Single Seat, Straight Back, Upholstered Back		
1	Seat fabric Gr.5	2433
2	Back fabric Gr.3	340
3	Lumbar fabric Gr.3	171
4	Base fabric Gr.5	242
Total:		\$3185

STHBU Borough Single Seat, Straight Back, Upholstered Back		
1	Seat fabric Gr.5	2433
2	Back fabric Gr.9	711
3	Lumbar fabric Gr.9	356
4	Base fabric Gr.5	242
Total:		\$3742

weights

Borough Single Seat, Angled Back	101 - 107 lbs
Borough Single Seat, Arm Right Facing, Angled Back	101 - 107 lbs
Borough Single Seat, Arm Left Facing, Angled Back	101 - 107 lbs
Borough Chaise, Arm Right Facing, Angled Back	101 - 107 lbs
Borough Chaise, Arm Left Facing, Angled Back	101 - 107 lbs
Borough Single Seat, Straight Back	101 - 107 lbs
Borough Single Seat, Arm Right Facing, Straight Back	101 - 107 lbs
Borough Single Seat, Arm Left Facing, Straight Back	101 - 107 lbs
Borough Single Seat, 90 Corner, Straight Back	111 - 117 lbs
Borough Single Seat, 45 Inside, Straight Back	106 - 112 lbs
Borough Single Seat, 60 Inside, Straight Back	111 - 117 lbs
Borough Single Seat, 30 Outside, Straight Back	106 - 112 lbs
Borough Single Seat, 22.5 Outside, Straight Back	101 - 106 lbs
Borough Chaise, Arm Right Facing, Straight Back	101 - 107 lbs
Borough Chaise, Arm Left Facing, Straight Back	101 - 107 lbs
Borough Bench, Rectangle	86 - 91 lbs
Borough Bench, Square	80 - 85 lbs
Borough Rounded Bench, Right Facing	110 - 117 lbs
Borough Rounded Bench, Left Facing	110 - 117 lbs
Borough Bench, 45 Inside, Straight Back	91 - 96 lbs
Borough Bench, 60 Inside, Straight Back	96 - 101 lbs
Borough Bench, 30 Outside, Straight Back	87 - 92 lbs
Borough Bench, 22.5 Outside, Straight Back	86 - 91 lbs

COM/COL material
requirement

Yardage is based on a non-patterned fabric. Additional yardage may be required for pattern repeats and the matching required. Leather yield may be affected by the quality of the COL. However, variance in the size of the hides will not affect the yield.

SINGLE UPHOLSTERY		COM [yards]	COL [sq. ft.]
Single Seat, Angled Back, No Arm	Seat	3 1/4	58 1/2
	Back	4	72
	Base	2	36
Single Seat, Angled Back One Arm	Seat & Arm	5	90
	Back	4	72
	Base	2	36
Chaise, Angled Back One Arm	Seat & Arm	5	90
	Back	4	72
	Base	2	36
Single Seat, Straight Back, No Arm	Seat	3 1/4	58 1/2
	Back	4	72
	Base	2	36
	Pillow	2	36
Single Seat, Straight Back One Arm	Seat & Arm	5	90
	Back	4	72
	Base	2	36
	Pillow	2	36
Chaise, Straight Back One Arm	Seat & Arm	5	90
	Back	4	72
	Base	2	36
	Pillow	2	36
Single Seat, 45 Inside, Straight Back	Seat	3	54
	Back	3 3/4	67 1/2
	Base	2	36
	Pillow	2	36
Single Seat, 60 Inside, Straight Back	Seat	3 3/4	67 1/2
	Back	5 1/2	99
	Base	2	36
	Pillow	2 1/2	45
Single Seat, 30 Outside, Straight Back	Seat	3 3/4	67 1/2
	Back	4 1/4	76 1/2
	Base	2	36
	Pillow	2	36
Single Seat, 22.5 Outside, Straight Back	Seat	3 3/4	67 1/2
	Back	4 1/4	76 1/2
	Base	2	36
	Pillow	2	36
Single Seat, 90 Corner, Straight Back	Seat	2 1/2	45
	Back	4 1/4	76 1/2
	Base	2	36
	Pillow	2	36
Bench, Rectangle	Seat	4	72
	Base	2	36
Bench, Square	Seat	3 1/2	63
	Base	2	36
Rounded Bench	Seat	6	108
	Base	2	36
Bench, 45 Inside	Seat	3 3/4	67 1/2
	Base	2	36
Bench, 60 Inside	Seat	5	90
	Base	2	36
Bench, 30 Outside	Seat	5	90
	Base	2	36
Bench, 22.5 Outside	Seat	4 1/4	76 1/2
	Base	2	36
Pillows	Short, Lumbar	2	36
	Long, Lumbar	2	36
	Rectangle	2	36

STHA **borough single seat, angled back**

Product Options

Base Style	Seat Upholstery Finish	Back Upholstery Finish	Base Finish
U Upholstered	Fabric Leather	Fabric Leather	Fabric Leather

Note All pillows are sold separately for Angled Back version

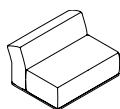

		Seat												
		COM	COL	Gr.1	Gr.2	Gr.3	Gr.4	Gr.5	Gr.6	Gr.7	Gr.8	Gr.9	Gr.10	Gr.11
U Upholstered		2039	2162	2190	2257	2315	2383	2433	2475	2517	2567	2617	2668	2726
												Leather		
U Upholstered		Gr.12	Gr.13	Gr.14	Gr.15	Gr.16	Gr.17	Gr.18	Gr.19	Gr.20	LB	LC	LD	
		2793	2877	2960	3045	3129	3212	3296	3380	3464	3067	3519	3670	
		Back												
		COM	COL	Gr.1	Gr.2	Gr.3	Gr.4	Gr.5	Gr.6	Gr.7	Gr.8	Gr.9	Gr.10	Gr.11
U Upholstered		0	116	186	268	340	422	485	536	588	650	711	774	846
												Leather		
U Upholstered		Gr.12	Gr.13	Gr.14	Gr.15	Gr.16	Gr.17	Gr.18	Gr.19	Gr.20	LB	LC	LD	
		928	1031	1134	1238	1341	1443	1546	1650	1753	1230	1786	1972	
		Base												
		COM	COL	Gr.1	Gr.2	Gr.3	Gr.4	Gr.5	Gr.6	Gr.7	Gr.8	Gr.9	Gr.10	Gr.11
U Upholstered		0	116	93	135	171	211	242	268	293	325	356	386	422
												Leather		
U Upholstered		Gr.12	Gr.13	Gr.14	Gr.15	Gr.16	Gr.17	Gr.18	Gr.19	Gr.20	LB	LC	LD	
		464	515	567	618	670	722	774	825	877	673	951	1044	

STHE **borough** single seat, arm right facing, angled back

Product Options

Base Style	Seat and Arm Upholstery Finish	Back Upholstery Finish	Base Finish
U Upholstered	Fabric Leather	Fabric Leather	Fabric Leather

Note All pillows are sold separately for Angled Back version

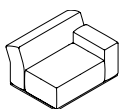

		Seat												
		COM	COL	Gr.1	Gr.2	Gr.3	Gr.4	Gr.5	Gr.6	Gr.7	Gr.8	Gr.9	Gr.10	Gr.11
U Upholstered		2354	2495	2586	2689	2779	2883	2959	3024	3088	3166	3243	3320	3410
													Leather	
U Upholstered		Gr.12	Gr.13	Gr.14	Gr.15	Gr.16	Gr.17	Gr.18	Gr.19	Gr.20	LB	LC	LD	
		3514	3642	3771	3900	4029	4159	4287	4416	4545	3887	4583	4815	
		Back												
		COM	COL	Gr.1	Gr.2	Gr.3	Gr.4	Gr.5	Gr.6	Gr.7	Gr.8	Gr.9	Gr.10	Gr.11
U Upholstered		0	116	186	268	340	422	485	536	588	650	711	774	846
													Leather	
U Upholstered		Gr.12	Gr.13	Gr.14	Gr.15	Gr.16	Gr.17	Gr.18	Gr.19	Gr.20	LB	LC	LD	
		928	1031	1134	1238	1341	1443	1546	1650	1753	1230	1786	1972	
		Base												
		COM	COL	Gr.1	Gr.2	Gr.3	Gr.4	Gr.5	Gr.6	Gr.7	Gr.8	Gr.9	Gr.10	Gr.11
U Upholstered		0	116	93	135	171	211	242	268	293	325	356	386	422
													Leather	
U Upholstered		Gr.12	Gr.13	Gr.14	Gr.15	Gr.16	Gr.17	Gr.18	Gr.19	Gr.20	LB	LC	LD	
		464	515	567	618	670	722	774	825	877	673	951	1044	

STHF **borough single seat, arm left facing, angled back**

Product Options

Base Style	Seat and Arm Upholstery Finish	Back Upholstery Finish	Base Finish
U Upholstered	Fabric Leather	Fabric Leather	Fabric Leather

Note All pillows are sold separately for Angled Back version

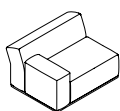

		Seat												
		COM	COL	Gr.1	Gr.2	Gr.3	Gr.4	Gr.5	Gr.6	Gr.7	Gr.8	Gr.9	Gr.10	Gr.11
U Upholstered		2354	2495	2586	2689	2779	2883	2959	3024	3088	3166	3243	3320	3410
												Leather		
U Upholstered		Gr.12	Gr.13	Gr.14	Gr.15	Gr.16	Gr.17	Gr.18	Gr.19	Gr.20	LB	LC	LD	
		3514	3642	3771	3900	4029	4159	4287	4416	4545	3887	4583	4815	
		Back												
		COM	COL	Gr.1	Gr.2	Gr.3	Gr.4	Gr.5	Gr.6	Gr.7	Gr.8	Gr.9	Gr.10	Gr.11
U Upholstered		0	116	186	268	340	422	485	536	588	650	711	774	846
												Leather		
U Upholstered		Gr.12	Gr.13	Gr.14	Gr.15	Gr.16	Gr.17	Gr.18	Gr.19	Gr.20	LB	LC	LD	
		928	1031	1134	1238	1341	1443	1546	1650	1753	1230	1786	1972	
		Base												
		COM	COL	Gr.1	Gr.2	Gr.3	Gr.4	Gr.5	Gr.6	Gr.7	Gr.8	Gr.9	Gr.10	Gr.11
U Upholstered		0	116	93	135	171	211	242	268	293	325	356	386	422
												Leather		
U Upholstered		Gr.12	Gr.13	Gr.14	Gr.15	Gr.16	Gr.17	Gr.18	Gr.19	Gr.20	LB	LC	LD	
		464	515	567	618	670	722	774	825	877	673	951	1044	

STHG **borough chaise, arm right facing, angled back**

Product Options

Base Style	Seat and Arm Upholstery Finish	Back Upholstery Finish	Base Finish
U Upholstered	Fabric Leather	Fabric Leather	Fabric Leather

Note All pillows are sold separately for Angled Back version

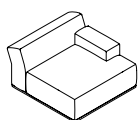

		Seat												
		COM	COL	Gr.1	Gr.2	Gr.3	Gr.4	Gr.5	Gr.6	Gr.7	Gr.8	Gr.9	Gr.10	Gr.11
U Upholstered		2668	2828	2900	3003	3094	3197	3274	3338	3402	3480	3558	3634	3725
												Leather		
U Upholstered		Gr.12	Gr.13	Gr.14	Gr.15	Gr.16	Gr.17	Gr.18	Gr.19	Gr.20		LB	LC	LD
		3828	3957	4086	4214	4343	4473	4602	4730	4859		4220	4916	5148
		Back												
		COM	COL	Gr.1	Gr.2	Gr.3	Gr.4	Gr.5	Gr.6	Gr.7	Gr.8	Gr.9	Gr.10	Gr.11
U Upholstered		0	116	186	268	340	422	485	536	588	650	711	774	846
												Leather		
U Upholstered		Gr.12	Gr.13	Gr.14	Gr.15	Gr.16	Gr.17	Gr.18	Gr.19	Gr.20		LB	LC	LD
		928	1031	1134	1238	1341	1443	1546	1650	1753		1230	1786	1972
		Base												
		COM	COL	Gr.1	Gr.2	Gr.3	Gr.4	Gr.5	Gr.6	Gr.7	Gr.8	Gr.9	Gr.10	Gr.11
U Upholstered		0	116	93	135	171	211	242	268	293	325	356	386	422
												Leather		
U Upholstered		Gr.12	Gr.13	Gr.14	Gr.15	Gr.16	Gr.17	Gr.18	Gr.19	Gr.20		LB	LC	LD
		464	515	567	618	670	722	774	825	877		673	951	1044

STHH **borough chaise, arm left facing, angled back**

Product Options

Base Style	Seat and Arm Upholstery Finish	Back Upholstery Finish	Base Finish
U Upholstered	Fabric Leather	Fabric Leather	Fabric Leather

Note All pillows are sold separately for Angled Back version

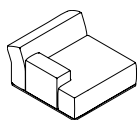

		Seat												
		COM	COL	Gr.1	Gr.2	Gr.3	Gr.4	Gr.5	Gr.6	Gr.7	Gr.8	Gr.9	Gr.10	Gr.11
U Upholstered		2668	2828	2900	3003	3094	3197	3274	3338	3402	3480	3558	3634	3725
												Leather		
U Upholstered		Gr.12	Gr.13	Gr.14	Gr.15	Gr.16	Gr.17	Gr.18	Gr.19	Gr.20		LB	LC	LD
		3828	3957	4086	4214	4343	4473	4602	4730	4859		4220	4916	5148
		Back												
		COM	COL	Gr.1	Gr.2	Gr.3	Gr.4	Gr.5	Gr.6	Gr.7	Gr.8	Gr.9	Gr.10	Gr.11
U Upholstered		0	116	186	268	340	422	485	536	588	650	711	774	846
												Leather		
U Upholstered		Gr.12	Gr.13	Gr.14	Gr.15	Gr.16	Gr.17	Gr.18	Gr.19	Gr.20		LB	LC	LD
		928	1031	1134	1238	1341	1443	1546	1650	1753		1230	1786	1972
		Base												
		COM	COL	Gr.1	Gr.2	Gr.3	Gr.4	Gr.5	Gr.6	Gr.7	Gr.8	Gr.9	Gr.10	Gr.11
U Upholstered		0	116	93	135	171	211	242	268	293	325	356	386	422
												Leather		
U Upholstered		Gr.12	Gr.13	Gr.14	Gr.15	Gr.16	Gr.17	Gr.18	Gr.19	Gr.20		LB	LC	LD
		464	515	567	618	670	722	774	825	877		673	951	1044

STHC **borough single seat, arm right facing, straight back**

Product Options

Base Style	Seat and Arm Upholstery Finish	Back Upholstery Finish	Lumbar Pillow Upholstery Finish	Base Finish
U Upholstered	Fabric Leather	Fabric Leather	Fabric Leather	Fabric Leather

Note Lumbar pillow always included and attached on the Straight Back version

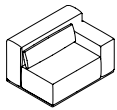

		Seat												
		COM	COL	Gr.1	Gr.2	Gr.3	Gr.4	Gr.5	Gr.6	Gr.7	Gr.8	Gr.9	Gr.10	Gr.11
U Upholstered		2354	2495	2586	2689	2779	2883	2959	3024	3088	3166	3243	3320	3410
												Leather		
U Upholstered		Gr.12	Gr.13	Gr.14	Gr.15	Gr.16	Gr.17	Gr.18	Gr.19	Gr.20		LB	LC	LD
		3514	3642	3771	3900	4029	4159	4287	4416	4545		3887	4583	4815
		Back												
		COM	COL	Gr.1	Gr.2	Gr.3	Gr.4	Gr.5	Gr.6	Gr.7	Gr.8	Gr.9	Gr.10	Gr.11
U Upholstered		0	116	186	268	340	422	485	536	588	650	711	774	846
												Leather		
U Upholstered		Gr.12	Gr.13	Gr.14	Gr.15	Gr.16	Gr.17	Gr.18	Gr.19	Gr.20		LB	LC	LD
		928	1031	1134	1238	1341	1443	1546	1650	1753		1230	1786	1972
		Lumbar Pillow												
		COM	COL	Gr.1	Gr.2	Gr.3	Gr.4	Gr.5	Gr.6	Gr.7	Gr.8	Gr.9	Gr.10	Gr.11
U Upholstered		0	116	93	135	171	211	242	268	293	325	356	386	422
												Leather		
U Upholstered		Gr.12	Gr.13	Gr.14	Gr.15	Gr.16	Gr.17	Gr.18	Gr.19	Gr.20		LB	LC	LD
		464	515	567	618	670	722	774	825	877		673	951	1044
		Base												
		COM	COL	Gr.1	Gr.2	Gr.3	Gr.4	Gr.5	Gr.6	Gr.7	Gr.8	Gr.9	Gr.10	Gr.11
U Upholstered		0	116	93	135	171	211	242	268	293	325	356	386	422
												Leather		
U Upholstered		Gr.12	Gr.13	Gr.14	Gr.15	Gr.16	Gr.17	Gr.18	Gr.19	Gr.20		LB	LC	LD
		464	515	567	618	670	722	774	825	877		673	951	1044

STHD **borough single seat, arm left facing, straight back**

Product Options

Base Style	Seat and Arm Upholstery Finish	Back Upholstery Finish	Lumbar Pillow Upholstery Finish	Base Finish
U Upholstered	Fabric Leather	Fabric Leather	Fabric Leather	Fabric Leather

Note Lumbar pillow always included and attached on the Straight Back version

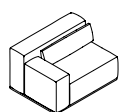

		Seat												
		COM	COL	Gr.1	Gr.2	Gr.3	Gr.4	Gr.5	Gr.6	Gr.7	Gr.8	Gr.9	Gr.10	Gr.11
U Upholstered		2354	2495	2586	2689	2779	2883	2959	3024	3088	3166	3243	3320	3410
												Leather		
U Upholstered		Gr.12	Gr.13	Gr.14	Gr.15	Gr.16	Gr.17	Gr.18	Gr.19	Gr.20		LB	LC	LD
		3514	3642	3771	3900	4029	4159	4287	4416	4545		3887	4583	4815
		Back												
		COM	COL	Gr.1	Gr.2	Gr.3	Gr.4	Gr.5	Gr.6	Gr.7	Gr.8	Gr.9	Gr.10	Gr.11
U Upholstered		0	116	186	268	340	422	485	536	588	650	711	774	846
												Leather		
U Upholstered		Gr.12	Gr.13	Gr.14	Gr.15	Gr.16	Gr.17	Gr.18	Gr.19	Gr.20		LB	LC	LD
		928	1031	1134	1238	1341	1443	1546	1650	1753		1230	1786	1972
		Lumbar Pillow												
		COM	COL	Gr.1	Gr.2	Gr.3	Gr.4	Gr.5	Gr.6	Gr.7	Gr.8	Gr.9	Gr.10	Gr.11
U Upholstered		0	116	93	135	171	211	242	268	293	325	356	386	422
												Leather		
U Upholstered		Gr.12	Gr.13	Gr.14	Gr.15	Gr.16	Gr.17	Gr.18	Gr.19	Gr.20		LB	LC	LD
		464	515	567	618	670	722	774	825	877		673	951	1044
		Base												
		COM	COL	Gr.1	Gr.2	Gr.3	Gr.4	Gr.5	Gr.6	Gr.7	Gr.8	Gr.9	Gr.10	Gr.11
U Upholstered		0	116	93	135	171	211	242	268	293	325	356	386	422
												Leather		
U Upholstered		Gr.12	Gr.13	Gr.14	Gr.15	Gr.16	Gr.17	Gr.18	Gr.19	Gr.20		LB	LC	LD
		464	515	567	618	670	722	774	825	877		673	951	1044

STHK **borough chaise, arm left facing, straight back**

Product Options

Base Style	Seat and Arm Upholstery Finish	Back Upholstery Finish	Lumbar Pillow Upholstery Finish	Base Finish
U Upholstered	Fabric Leather	Fabric Leather	Fabric Leather	Fabric Leather

Note Lumbar pillow always included and attached on the Straight Back version

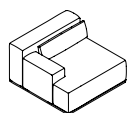

		Seat													
		COM	COL	Gr.1	Gr.2	Gr.3	Gr.4	Gr.5	Gr.6	Gr.7	Gr.8	Gr.9	Gr.10	Gr.11	
U Upholstered		2668	2828	2900	3003	3094	3197	3274	3338	3402	3480	3558	3634	3725	
													Leather		
U Upholstered		Gr.12	Gr.13	Gr.14	Gr.15	Gr.16	Gr.17	Gr.18	Gr.19	Gr.20		LB	LC	LD	
		3828	3957	4086	4214	4343	4473	4602	4730	4859		4220	4916	5148	
		Back													
		COM	COL	Gr.1	Gr.2	Gr.3	Gr.4	Gr.5	Gr.6	Gr.7	Gr.8	Gr.9	Gr.10	Gr.11	
U Upholstered		0	116	186	268	340	422	485	536	588	650	711	774	846	
													Leather		
U Upholstered		Gr.12	Gr.13	Gr.14	Gr.15	Gr.16	Gr.17	Gr.18	Gr.19	Gr.20		LB	LC	LD	
		928	1031	1134	1238	1341	1443	1546	1650	1753		1230	1786	1972	
		Lumbar Pillow													
		COM	COL	Gr.1	Gr.2	Gr.3	Gr.4	Gr.5	Gr.6	Gr.7	Gr.8	Gr.9	Gr.10	Gr.11	
U Upholstered		0	116	93	135	171	211	242	268	293	325	356	386	422	
													Leather		
U Upholstered		Gr.12	Gr.13	Gr.14	Gr.15	Gr.16	Gr.17	Gr.18	Gr.19	Gr.20		LB	LC	LD	
		464	515	567	618	670	722	774	825	877		673	951	1044	
		Base													
		COM	COL	Gr.1	Gr.2	Gr.3	Gr.4	Gr.5	Gr.6	Gr.7	Gr.8	Gr.9	Gr.10	Gr.11	
U Upholstered		0	116	93	135	171	211	242	268	293	325	356	386	422	
													Leather		
U Upholstered		Gr.12	Gr.13	Gr.14	Gr.15	Gr.16	Gr.17	Gr.18	Gr.19	Gr.20		LB	LC	LD	
		464	515	567	618	670	722	774	825	877		673	951	1044	

STHL **borough single seat, 90 corner, straight back**

Product Options

Base Style	Seat and Arm Upholstery Finish	Back Upholstery Finish	Lumbar Pillow Upholstery Finish	Base Finish
U Upholstered	Fabric Leather	Fabric Leather	Fabric Leather	Fabric Leather

Note Lumbar pillow always included and attached on the Straight Back version

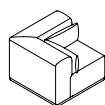

	Seat												
	COM	COL	Gr.1	Gr.2	Gr.3	Gr.4	Gr.5	Gr.6	Gr.7	Gr.8	Gr.9	Gr.10	Gr.11
U Upholstered	2239	2374	2355	2407	2452	2503	2542	2574	2606	2645	2684	2722	2767
											Leather		
											LB	LC	LD
U Upholstered	2819	2883	2948	3012	3077	3141	3206	3270	3335		3070	3418	3534
	Back												
	COM	COL	Gr.1	Gr.2	Gr.3	Gr.4	Gr.5	Gr.6	Gr.7	Gr.8	Gr.9	Gr.10	Gr.11
U Upholstered	0	116	197	285	362	449	515	570	624	690	756	822	898
											Leather		
											LB	LC	LD
U Upholstered	986	1096	1205	1315	1424	1534	1643	1753	1862		1283	1875	2072
	Lumbar Pillow												
	COM	COL	Gr.1	Gr.2	Gr.3	Gr.4	Gr.5	Gr.6	Gr.7	Gr.8	Gr.9	Gr.10	Gr.11
U Upholstered	0	116	93	135	171	211	242	268	293	325	356	386	422
											Leather		
											LB	LC	LD
U Upholstered	464	515	567	618	670	722	774	825	877		673	951	1044
	Base												
	COM	COL	Gr.1	Gr.2	Gr.3	Gr.4	Gr.5	Gr.6	Gr.7	Gr.8	Gr.9	Gr.10	Gr.11
U Upholstered	0	116	93	135	171	211	242	268	293	325	356	386	422
											Leather		
											LB	LC	LD
U Upholstered	464	515	567	618	670	722	774	825	877		673	951	1044

STHW **borough single seat, 45 inside curve, straight back**

Product Options

Base Style	Seat and Arm Upholstery Finish	Back Upholstery Finish	Lumbar Pillow Upholstery Finish	Base Finish
U Upholstered	Fabric Leather	Fabric Leather	Fabric Leather	Fabric Leather

Note Lumbar pillow always included and attached on the Straight Back version

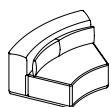

		Seat												
		COM	COL	Gr.1	Gr.2	Gr.3	Gr.4	Gr.5	Gr.6	Gr.7	Gr.8	Gr.9	Gr.10	Gr.11
U Upholstered		2139	2268	2313	2390	2458	2535	2593	2642	2690	2748	2806	2864	2932
												Leather		
U Upholstered		Gr.12	Gr.13	Gr.14	Gr.15	Gr.16	Gr.17	Gr.18	Gr.19	Gr.20		LB	LC	LD
		3009	3106	3202	3299	3396	3492	3589	3686	3782		3103	3834	4008
		Back												
		COM	COL	Gr.1	Gr.2	Gr.3	Gr.4	Gr.5	Gr.6	Gr.7	Gr.8	Gr.9	Gr.10	Gr.11
U Upholstered		0	116	174	251	319	396	454	503	551	609	667	725	793
												Leather		
U Upholstered		Gr.12	Gr.13	Gr.14	Gr.15	Gr.16	Gr.17	Gr.18	Gr.19	Gr.20		LB	LC	LD
		870	967	1063	1160	1257	1353	1450	1547	1643		1144	1666	1840
		Lumbar Pillow												
		COM	COL	Gr.1	Gr.2	Gr.3	Gr.4	Gr.5	Gr.6	Gr.7	Gr.8	Gr.9	Gr.10	Gr.11
U Upholstered		0	116	93	135	171	211	242	268	293	325	356	386	422
												Leather		
U Upholstered		Gr.12	Gr.13	Gr.14	Gr.15	Gr.16	Gr.17	Gr.18	Gr.19	Gr.20		LB	LC	LD
		464	515	567	618	670	722	774	825	877		673	951	1044
		Base												
		COM	COL	Gr.1	Gr.2	Gr.3	Gr.4	Gr.5	Gr.6	Gr.7	Gr.8	Gr.9	Gr.10	Gr.11
U Upholstered		0	116	93	135	171	211	242	268	293	325	356	386	422
												Leather		
U Upholstered		Gr.12	Gr.13	Gr.14	Gr.15	Gr.16	Gr.17	Gr.18	Gr.19	Gr.20		LB	LC	LD
		464	515	567	618	670	722	774	825	877		673	951	1044

STHX **borough single seat, 60 inside curve, straight back**

Product Options

Base Style	Seat and Arm Upholstery Finish	Back Upholstery Finish	Lumbar Pillow Upholstery Finish	Base Finish
U Upholstered	Fabric Leather	Fabric Leather	Fabric Leather	Fabric Leather

Note Lumbar pillow always included and attached on the Straight Back version



		Seat													
		COM	COL	Gr.1	Gr.2	Gr.3	Gr.4	Gr.5	Gr.6	Gr.7	Gr.8	Gr.9	Gr.10	Gr.11	
U Upholstered		2439	2586	2613	2690	2758	2835	2893	2942	2990	3048	3106	3164	3232	
													Leather		
													LB	LC	LD
U Upholstered		3309	3406	3502	3599	3696	3792	3889	3986	4082		3630	4152	4326	
		Back													
		COM	COL	Gr.1	Gr.2	Gr.3	Gr.4	Gr.5	Gr.6	Gr.7	Gr.8	Gr.9	Gr.10	Gr.11	
U Upholstered		0	116	255	369	468	581	666	737	808	893	978	1063	1163	
													Leather		
													LB	LC	LD
U Upholstered		1276	1418	1560	1701	1843	1985	2127	2268	2410		1631	2397	2652	
		Lumbar Pillow													
		COM	COL	Gr.1	Gr.2	Gr.3	Gr.4	Gr.5	Gr.6	Gr.7	Gr.8	Gr.9	Gr.10	Gr.11	
U Upholstered		0	116	116	168	213	264	303	335	367	406	445	483	528	
													Leather		
													LB	LC	LD
U Upholstered		580	644	709	773	838	902	967	1031	1096		796	1144	1260	
		Base													
		COM	COL	Gr.1	Gr.2	Gr.3	Gr.4	Gr.5	Gr.6	Gr.7	Gr.8	Gr.9	Gr.10	Gr.11	
U Upholstered		0	116	93	135	171	211	242	268	293	325	356	386	422	
													Leather		
													LB	LC	LD
U Upholstered		464	515	567	618	670	722	774	825	877		673	951	1044	

STHY **borough single seat, 30 outside curve, straight back**

Product Options

Base Style	Seat and Arm Upholstery Finish	Back Upholstery Finish	Lumbar Pillow Upholstery Finish	Base Finish
U Upholstered	Fabric Leather	Fabric Leather	Fabric Leather	Fabric Leather

Note Lumbar pillow always included and attached on the Straight Back version

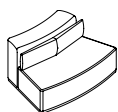

		Seat												
		COM	COL	Gr.1	Gr.2	Gr.3	Gr.4	Gr.5	Gr.6	Gr.7	Gr.8	Gr.9	Gr.10	Gr.11
U Upholstered		2439	2586	2613	2690	2758	2835	2893	2942	2990	3048	3106	3164	3232
												Leather		
												LB	LC	LD
U Upholstered		3309	3406	3502	3599	3696	3792	3889	3986	4082		3630	4152	4326
		Back												
		COM	COL	Gr.1	Gr.2	Gr.3	Gr.4	Gr.5	Gr.6	Gr.7	Gr.8	Gr.9	Gr.10	Gr.11
U Upholstered		0	116	197	285	362	449	515	570	624	690	756	822	898
												Leather		
												LB	LC	LD
U Upholstered		986	1096	1205	1315	1424	1534	1643	1753	1862		1283	1875	2072
		Lumbar Pillow												
		COM	COL	Gr.1	Gr.2	Gr.3	Gr.4	Gr.5	Gr.6	Gr.7	Gr.8	Gr.9	Gr.10	Gr.11
U Upholstered		0	116	93	135	171	211	242	268	293	325	356	386	422
												Leather		
												LB	LC	LD
U Upholstered		464	515	567	618	670	722	774	825	877		673	951	1044
		Base												
		COM	COL	Gr.1	Gr.2	Gr.3	Gr.4	Gr.5	Gr.6	Gr.7	Gr.8	Gr.9	Gr.10	Gr.11
U Upholstered		0	116	93	135	171	211	242	268	293	325	356	386	422
												Leather		
												LB	LC	LD
U Upholstered		464	515	567	618	670	722	774	825	877		673	951	1044

STHZ **borough single seat, 22.5 outside curve, straight back**

Product Options

Base Style	Seat and Arm Upholstery Finish	Back Upholstery Finish	Lumbar Pillow Upholstery Finish	Base Finish
U Upholstered	Fabric Leather	Fabric Leather	Fabric Leather	Fabric Leather

Note Lumbar pillow always included and attached on the Straight Back version

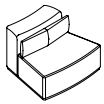

		Seat															
		COM	COL	Gr.1	Gr.2	Gr.3	Gr.4	Gr.5	Gr.6	Gr.7	Gr.8	Gr.9	Gr.10	Gr.11			
U Upholstered		2139	2268	2313	2390	2458	2535	2593	2642	2690	2748	2806	2864	2932			
												Leather					
U Upholstered		3009	3106	3202	3299	3396	3492	3589	3686	3782		3312	3834	4008	LB	LC	LD
		Back															
		COM	COL	Gr.1	Gr.2	Gr.3	Gr.4	Gr.5	Gr.6	Gr.7	Gr.8	Gr.9	Gr.10	Gr.11			
U Upholstered		0	116	197	285	362	449	515	570	624	690	756	822	898			
												Leather					
U Upholstered		986	1096	1205	1315	1424	1534	1643	1753	1862		1283	1875	2072	LB	LC	LD
		Lumbar Pillow															
		COM	COL	Gr.1	Gr.2	Gr.3	Gr.4	Gr.5	Gr.6	Gr.7	Gr.8	Gr.9	Gr.10	Gr.11			
U Upholstered		0	116	93	135	171	211	242	268	293	325	356	386	422			
												Leather					
U Upholstered		464	515	567	618	670	722	774	825	877		673	951	1044	LB	LC	LD
		Base															
		COM	COL	Gr.1	Gr.2	Gr.3	Gr.4	Gr.5	Gr.6	Gr.7	Gr.8	Gr.9	Gr.10	Gr.11			
U Upholstered		0	116	93	135	171	211	242	268	293	325	356	386	422			
												Leather					
U Upholstered		464	515	567	618	670	722	774	825	877		673	951	1044	LB	LC	LD

STHM **borough bench, rectangle**

Product Options

Base Style	Seat Upholstery Finish	Base Finish
U Upholstered	Fabric Leather	Fabric Leather

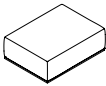

	Seat												
	COM	COL	Gr.1	Gr.2	Gr.3	Gr.4	Gr.5	Gr.6	Gr.7	Gr.8	Gr.9	Gr.10	Gr.11
U Upholstered	1369	1451	1554	1637	1709	1791	1854	1905	1957	2018	2080	2143	2214
											Leather		
U Upholstered	Gr.12	Gr.13	Gr.14	Gr.15	Gr.16	Gr.17	Gr.18	Gr.19	Gr.20		LB	LC	LD
	2297	2400	2503	2607	2710	2812	2915	3018	3122		2565	3122	3307
	Base												
	COM	COL	Gr.1	Gr.2	Gr.3	Gr.4	Gr.5	Gr.6	Gr.7	Gr.8	Gr.9	Gr.10	Gr.11
U Upholstered	0	116	93	135	171	211	242	268	293	325	356	386	422
											Leather		
U Upholstered	Gr.12	Gr.13	Gr.14	Gr.15	Gr.16	Gr.17	Gr.18	Gr.19	Gr.20		LB	LC	LD
	464	515	567	618	670	722	774	825	877		673	951	1044

STHN **borough bench, square**

Product Options

Base Style	Seat Upholstery Finish	Base Finish
U Upholstered	Fabric Leather	Fabric Leather



		Seat													
		COM	COL	Gr.1	Gr.2	Gr.3	Gr.4	Gr.5	Gr.6	Gr.7	Gr.8	Gr.9	Gr.10	Gr.11	
U Upholstered		1305	1384	1467	1539	1603	1675	1730	1774	1819	1873	1928	1981	2045	
													Leather		
U Upholstered		Gr.12	Gr.13	Gr.14	Gr.15	Gr.16	Gr.17	Gr.18	Gr.19	Gr.20		LB	LC	LD	
		2117	2207	2298	2387	2478	2568	2659	2748	2839		2358	2845	3008	
		Base													
		COM	COL	Gr.1	Gr.2	Gr.3	Gr.4	Gr.5	Gr.6	Gr.7	Gr.8	Gr.9	Gr.10	Gr.11	
U Upholstered		0	116	93	135	171	211	242	268	293	325	356	386	422	
													Leather		
U Upholstered		Gr.12	Gr.13	Gr.14	Gr.15	Gr.16	Gr.17	Gr.18	Gr.19	Gr.20		LB	LC	LD	
		464	515	567	618	670	722	774	825	877		673	951	1044	

STHR **borough rounded bench, right facing**

Product Options

Base Style	Seat Upholstery Finish	Base Finish
U Upholstered	Fabric Leather	Fabric Leather



		Seat												
		COM	COL	Gr.1	Gr.2	Gr.3	Gr.4	Gr.5	Gr.6	Gr.7	Gr.8	Gr.9	Gr.10	Gr.11
U Upholstered		1698	1800	1977	2101	2209	2333	2426	2502	2580	2673	2765	2858	2966
												Leather		
U Upholstered		Gr.12	Gr.13	Gr.14	Gr.15	Gr.16	Gr.17	Gr.18	Gr.19	Gr.20		LB	LC	LD
		3090	3245	3400	3554	3709	3864	4018	4173	4328		3471	4306	4584
		Base												
		COM	COL	Gr.1	Gr.2	Gr.3	Gr.4	Gr.5	Gr.6	Gr.7	Gr.8	Gr.9	Gr.10	Gr.11
U Upholstered		0	116	93	135	171	211	242	268	293	325	356	386	422
												Leather		
U Upholstered		Gr.12	Gr.13	Gr.14	Gr.15	Gr.16	Gr.17	Gr.18	Gr.19	Gr.20		LB	LC	LD
		464	515	567	618	670	722	774	825	877		673	951	1044

STHQ **borough rounded bench, left facing**

Product Options

Base Style	Seat Upholstery Finish	Base Finish
U Upholstered	Fabric Leather	Fabric Leather



		Seat												
		COM	COL	Gr.1	Gr.2	Gr.3	Gr.4	Gr.5	Gr.6	Gr.7	Gr.8	Gr.9	Gr.10	Gr.11
U Upholstered		1698	1800	1977	2101	2209	2333	2426	2502	2580	2673	2765	2858	2966
												Leather		
U Upholstered		Gr.12	Gr.13	Gr.14	Gr.15	Gr.16	Gr.17	Gr.18	Gr.19	Gr.20		LB	LC	LD
		3090	3245	3400	3554	3709	3864	4018	4173	4328		3471	4306	4584
		Base												
		COM	COL	Gr.1	Gr.2	Gr.3	Gr.4	Gr.5	Gr.6	Gr.7	Gr.8	Gr.9	Gr.10	Gr.11
U Upholstered		0	116	93	135	171	211	242	268	293	325	356	386	422
												Leather		
U Upholstered		Gr.12	Gr.13	Gr.14	Gr.15	Gr.16	Gr.17	Gr.18	Gr.19	Gr.20		LB	LC	LD
		464	515	567	618	670	722	774	825	877		673	951	1044

STHS borough 45 inside bench

Product Options

Base Style	Seat Upholstery Finish	Base Finish
U Upholstered	Fabric Leather	Fabric Leather

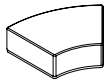

	Seat												
	COM	COL	Gr.1	Gr.2	Gr.3	Gr.4	Gr.5	Gr.6	Gr.7	Gr.8	Gr.9	Gr.10	Gr.11
U Upholstered	1698	1800	1872	1949	2017	2094	2152	2201	2249	2307	2365	2423	2491
											Leather		
	Gr.12	Gr.13	Gr.14	Gr.15	Gr.16	Gr.17	Gr.18	Gr.19	Gr.20		LB	LC	LD
U Upholstered	2568	2665	2761	2858	2955	3051	3148	3245	3341		2844	3366	3540
	Base												
	COM	COL	Gr.1	Gr.2	Gr.3	Gr.4	Gr.5	Gr.6	Gr.7	Gr.8	Gr.9	Gr.10	Gr.11
U Upholstered	0	116	93	135	171	211	242	268	293	325	356	386	422
											Leather		
	Gr.12	Gr.13	Gr.14	Gr.15	Gr.16	Gr.17	Gr.18	Gr.19	Gr.20		LB	LC	LD
U Upholstered	464	515	567	618	670	722	774	825	877		673	951	1044

STHT borough 60 inside bench

Product Options

Base Style	Seat Upholstery Finish	Base Finish
U Upholstered	Fabric Leather	Fabric Leather

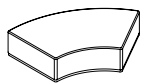

	Seat												
	COM	COL	Gr.1	Gr.2	Gr.3	Gr.4	Gr.5	Gr.6	Gr.7	Gr.8	Gr.9	Gr.10	Gr.11
U Upholstered	1998	2118	2230	2333	2423	2526	2604	2668	2733	2810	2887	2965	3055
												Leather	
	Gr.12	Gr.13	Gr.14	Gr.15	Gr.16	Gr.17	Gr.18	Gr.19	Gr.20		LB	LC	LD
U Upholstered	3158	3287	3416	3545	3674	3802	3931	4060	4189		3510	4206	4438
	Base												
	COM	COL	Gr.1	Gr.2	Gr.3	Gr.4	Gr.5	Gr.6	Gr.7	Gr.8	Gr.9	Gr.10	Gr.11
U Upholstered	0	116	93	135	171	211	242	268	293	325	356	386	422
												Leather	
	Gr.12	Gr.13	Gr.14	Gr.15	Gr.16	Gr.17	Gr.18	Gr.19	Gr.20		LB	LC	LD
U Upholstered	464	515	567	618	670	722	774	825	877		673	951	1044

STHU borough 30 outside bench

Product Options

Base Style	Seat Upholstery Finish	Base Finish
U Upholstered	Fabric Leather	Fabric Leather

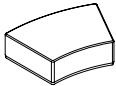

	Seat												
	COM	COL	Gr.1	Gr.2	Gr.3	Gr.4	Gr.5	Gr.6	Gr.7	Gr.8	Gr.9	Gr.10	Gr.11
U Upholstered	1998	2118	2230	2333	2423	2526	2604	2668	2733	2810	2887	2965	3055
											Leather		
	Gr.12	Gr.13	Gr.14	Gr.15	Gr.16	Gr.17	Gr.18	Gr.19	Gr.20	LB	LC	LD	
U Upholstered	3158	3287	3416	3545	3674	3802	3931	4060	4189	3510	4206	4438	
	Base												
	COM	COL	Gr.1	Gr.2	Gr.3	Gr.4	Gr.5	Gr.6	Gr.7	Gr.8	Gr.9	Gr.10	Gr.11
U Upholstered	0	116	93	135	171	211	242	268	293	325	356	386	422
											Leather		
	Gr.12	Gr.13	Gr.14	Gr.15	Gr.16	Gr.17	Gr.18	Gr.19	Gr.20	LB	LC	LD	
U Upholstered	464	515	567	618	670	722	774	825	877	673	951	1044	

STHV borough 22.5 outside bench

Product Options

Base Style	Seat Upholstery Finish	Base Finish
U Upholstered	Fabric Leather	Fabric Leather

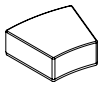

	Seat												
	COM	COL	Gr.1	Gr.2	Gr.3	Gr.4	Gr.5	Gr.6	Gr.7	Gr.8	Gr.9	Gr.10	Gr.11
U Upholstered	1698	1800	1895	1983	2060	2147	2213	2268	2322	2388	2454	2520	2596
											Leather		
U Upholstered	Gr.12	Gr.13	Gr.14	Gr.15	Gr.16	Gr.17	Gr.18	Gr.19	Gr.20		LB	LC	LD
	2684	2794	2903	3013	3122	3232	3341	3451	3560		2983	3575	3772
	Base												
	COM	COL	Gr.1	Gr.2	Gr.3	Gr.4	Gr.5	Gr.6	Gr.7	Gr.8	Gr.9	Gr.10	Gr.11
U Upholstered	0	116	93	135	171	211	242	268	293	325	356	386	422
											Leather		
U Upholstered	Gr.12	Gr.13	Gr.14	Gr.15	Gr.16	Gr.17	Gr.18	Gr.19	Gr.20		LB	LC	LD
	464	515	567	618	670	722	774	825	877		673	951	1044

STHPA **borough pillow, large rectangular**

Product Options

Pillow Upholstery Finish

Fabric

Leather



Seat												
COM	COL	Gr.1	Gr.2	Gr.3	Gr.4	Gr.5	Gr.6	Gr.7	Gr.8	Gr.9	Gr.10	Gr.11
382	405	474	516	552	593	624	650	675	706	738	768	804
										Leather		
Gr.12	Gr.13	Gr.14	Gr.15	Gr.16	Gr.17	Gr.18	Gr.19	Gr.20	LB	LC	LD	
846	897	949	1000	1052	1103	1155	1206	1259	962	1240	1333	

STHPB **borough pillow, lumbar, long**

Product Options

Pillow Upholstery Finish

Fabric

Leather

Note Sized for back version with no arms



Seat												
COM	COL	Gr.1	Gr.2	Gr.3	Gr.4	Gr.5	Gr.6	Gr.7	Gr.8	Gr.9	Gr.10	Gr.11
355	376	448	490	525	566	597	623	648	680	711	741	777
										Leather		
Gr.12	Gr.13	Gr.14	Gr.15	Gr.16	Gr.17	Gr.18	Gr.19	Gr.20	LB	LC	LD	
819	870	922	973	1025	1076	1129	1180	1232	933	1211	1304	

STHPC **borough pillow, lumbar short**

Product Options

Pillow Upholstery Finish

Fabric

Leather

Note Sized for back version with one arm



Seat												
COM	COL	Gr.1	Gr.2	Gr.3	Gr.4	Gr.5	Gr.6	Gr.7	Gr.8	Gr.9	Gr.10	Gr.11
329	349	422	464	500	541	572	597	623	654	686	716	752
										Leather		
Gr.12	Gr.13	Gr.14	Gr.15	Gr.16	Gr.17	Gr.18	Gr.19	Gr.20	LB	LC	LD	
793	844	897	948	1000	1051	1103	1154	1206	906	1184	1277	

cesto

features

Cesto, spanish for 'basket', is a collection of interactive seating and table elements designed to address the dynamic collaborative and social behaviors typical of today's work environment. The lightweight, easily mobile poufs allow for people within the office to move pieces around the space at their hearts content. The stools allow for quick touchdown collaboration at traditional 29" high tables and the poufs and benches with or without backs were designed for more social spaces and allowing for collaborative work at a 26" high table.

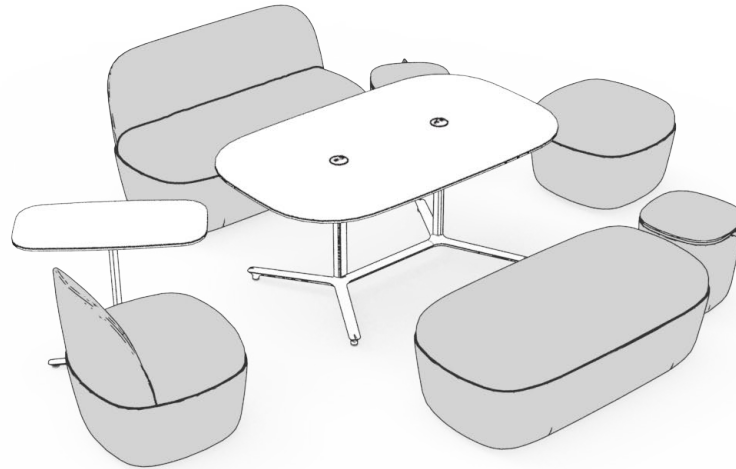

cesto

dimensions

- Designed and tested for users up to 300 lbs
- Meets ANSI/BIFMA requirements

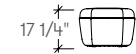
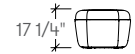
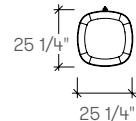
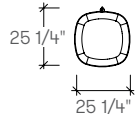

Cesto Stool, Knit Base
(STGA)

Cesto Stool, Fabric Base
(STGB)

Cesto Pouf, Knit Base
(STGC)

Cesto Pouf, Fabric Base
(STGD)

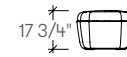
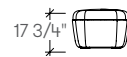
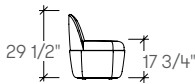
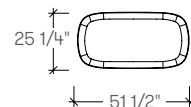
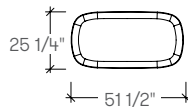
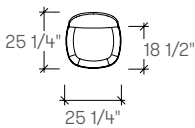
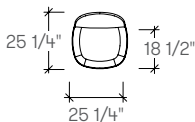

Cesto Pouf with Back, Knit Base
(STGG)

Cesto Pouf with Back, Fabric Base
(STGH)

Cesto Bench, Knit Base
(STGE)

Cesto Bench, Fabric Base
(STGF)

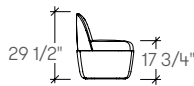
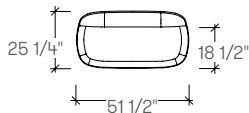

Cesto Bench with Back, Knit Base
(STGJ)

Cesto Bench with Back, Fabric Base
(STGK)

cesto

planning

A variety of configurations can be achieved with Cesto, allowing for various configurations. The following typical demonstrate the versatility that can be achieved.

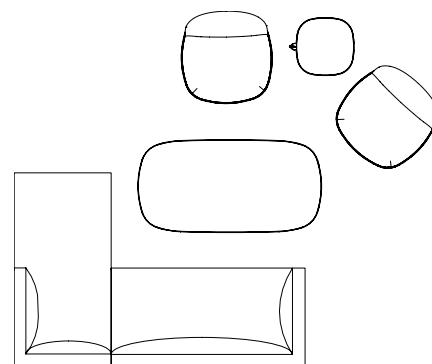
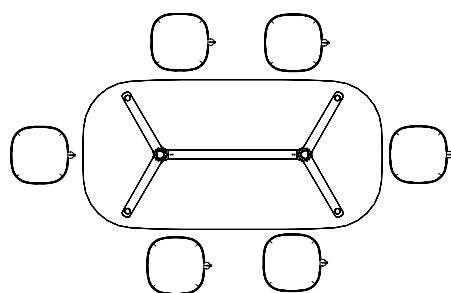
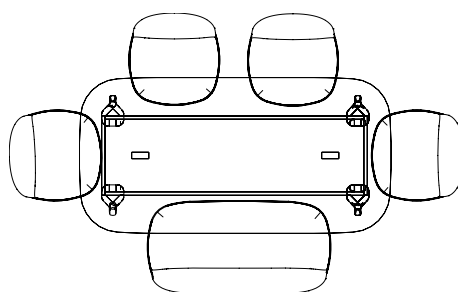
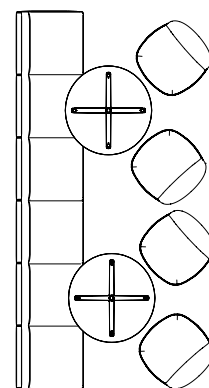
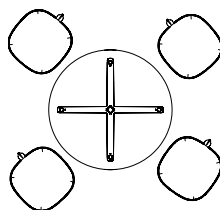
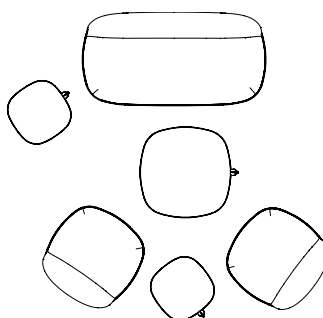
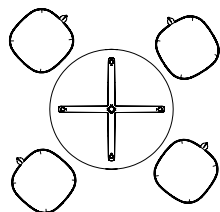
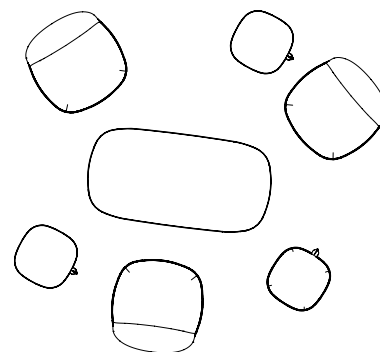
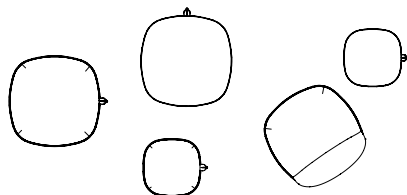
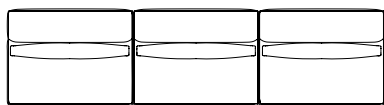

specifying cesto finishes

The modularity of Cesto permits a wide range of fabric combinations that allows for an expressive use of color, texture and material.

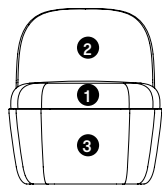

- 1 Seat Upholstery**
Select the seat upholstery
- 2 Back Upholstery**
Select the back upholstery
- 3 Base Finish**
Select knit finish or base upholstery

specification example

STGGN Cesto Pouf with Back, Knit Base, No Caster	
1 Seat fabric Gr.5	2161
2 Back fabric Gr.5	182
Total:	\$2343

STGGN Cesto Pouf with Back, Knit Base, No Caster	
1 Seat fabric Gr.5	2161
2 Back fabric Gr.3	128
Total:	\$2289

STGGN Cesto Pouf with Back, Knit Base, No Caster	
1 Seat fabric Gr.5	2161
2 Back fabric Gr.9	267
Total:	\$2428

STGHN Cesto Pouf with Back, Fabric Base, No Caster	
1 Seat fabric Gr.5	2277
2 Back fabric Gr.5	182
3 Base Upholstery Gr.5	242
Total:	\$2702

STGHN Cesto Pouf with Back, Fabric Base, No Caster	
1 Seat fabric Gr.5	2277
2 Back fabric Gr.3	128
3 Base Upholstery Gr.5	242
Total:	\$2647

STGHN Cesto Pouf with Back, Fabric Base, No Caster	
1 Seat fabric Gr.5	2277
2 Back fabric Gr.9	267
3 Base Upholstery Gr.5	242
Total:	\$2786

weights

Cesto Stool, Knit Base	28 - 32 lbs
Cesto Stool, Fabric Base	28 - 32 lbs
Cesto Pouf, Knit Base	32 - 37 lbs
Cesto Pouf, Fabric Base	32 - 37 lbs
Cesto Pouf with Back, Knit Base	37 - 42 lbs
Cesto Pouf with Back, Fabric Base	37 - 42 lbs
Cesto Bench, Knit Base	64 - 74 lbs
Cesto Bench, Fabric Base	64 - 74 lbs
Cesto Bench with Back, Knit Base	74 - 84 lbs
Cesto Bench with Back, Fabric Base	74 - 84 lbs

COM/COL material requirement

Yardage is based on a non-patterned fabric. Additional yardage may be required for pattern repeats and the matching required. Leather yield may be affected by the quality of the COL. However, variance in the size of the hides will not affect the yield.

SINGLE UPHOLSTERY		COM [yards]	COL [sq. ft.]
Stool	Seat	1 1/2	27
	Base	1 1/2	27
Pouf	Seat	1 3/4	31 1/2
	Base	2	36
Pouf w/ Back	Seat	1 3/4	31 1/2
	Back	1 1/2	27
	Base	2	36
Bench	Seat	3	54
	Base	3	54
Bench w/ Back	Seat	3	54
	Back	2 3/4	49 1/2
	Base	3	54

seam positions

Cesto seating with knit bases have two seams which are positioned on two sides from center of base to center of upper frame. Fabric bases have four seams which are positioned from the four corners.

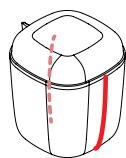

Knit Base

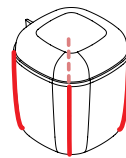

Fabric Base

STGC cesto pouf, knit base

Product Options

Style	Seat Pad Upholstery Finish	Knit Mesh Base Finish			
C Caster	Fabric	K413	Eggshell	K419	Goldenrod
N No Caster	Leather	K414	Stone	K420	Sunset
		K415	Khaki	K421	Cardinal
		K416	Silver	K422	Magenta
		K417	Taupe	K423	Cobalt
		K418	Graphite		

Note Natural Leather handle is included



	Price												
	COM	COL	Gr.1	Gr.2	Gr.3	Gr.4	Gr.5	Gr.6	Gr.7	Gr.8	Gr.9	Gr.10	Gr.11
C Caster	1305	1384	1386	1422	1453	1489	1517	1539	1563	1589	1616	1644	1675
N No Caster	1305	1384	1386	1422	1453	1489	1517	1539	1563	1589	1616	1644	1675
											Leather		
											LB	LC	LD
C Caster	1711	1756	1801	1847	1892	1936	1981	2027	2072		1871	2115	2196
N No Caster	1711	1756	1801	1847	1892	1936	1981	2027	2072		1871	2115	2196

STGD cesto pouf, fabric base

Product Options

Style	Seat Pad Upholstery Finish	Base Upholstery Finish	
C Caster	Fabric	Fabric	
N No Caster	Leather	Leather	

Note Natural Leather handle is included



	Seat																								
	COM	COL	Gr.1	Gr.2	Gr.3	Gr.4	Gr.5	Gr.6	Gr.7	Gr.8	Gr.9	Gr.10	Gr.11												
C Caster	1357	1438	1438	1474	1506	1542	1569	1592	1615	1641	1668	1696	1727												
N No Caster	1357	1438	1438	1474	1506	1542	1569	1592	1615	1641	1668	1696	1727												
											Leather														
											LB	LC	LD												
C Caster	1763	1808	1854	1899	1944	1988	2033	2079	2124		1926	2169	2250												
N No Caster	1763	1808	1854	1899	1944	1988	2033	2079	2124		1926	2169	2250												
													Base												
													COM	COL	Gr.1	Gr.2	Gr.3	Gr.4	Gr.5	Gr.6	Gr.7	Gr.8	Gr.9	Gr.10	Gr.11
C Caster		0	116	93	135	171	211	242	268	293	325	356	386	422											
N No Caster		0	116	93	135	171	211	242	268	293	325	356	386	422											
													Leather												
													LB	LC	LD										
C Caster		464	515	567	618	670	722	774	825	877		673	951	1044											
N No Caster		464	515	567	618	670	722	774	825	877		673	951	1044											

STGG cesto pouf with back, knit base

Product Options

Style	Seat Pad Upholstery Finish	Back Upholstery Finish	Knit Mesh Base Finish
C Caster	Fabric	Fabric	K413 Eggshell
N No Caster	Leather	Leather	K414 Stone
			K415 Khaki
			K416 Silver
			K417 Taupe
			K418 Graphite
			K419 Goldenrod
			K420 Sunset
			K421 Cardinal
			K422 Magenta
			K423 Cobalt



		Seat															
		COM	COL	Gr.1	Gr.2	Gr.3	Gr.4	Gr.5	Gr.6	Gr.7	Gr.8	Gr.9	Gr.10	Gr.11			
C	Caster	2013	2133	2094	2130	2161	2197	2225	2247	2270	2297	2323	2351	2383			
N	No Caster	2013	2133	2094	2130	2161	2197	2225	2247	2270	2297	2323	2351	2383			
													Leather				
		Gr.12	Gr.13	Gr.14	Gr.15	Gr.16	Gr.17	Gr.18	Gr.19	Gr.20		LB	LC	LD			
C	Caster	2419	2464	2509	2554	2600	2644	2689	2734	2779		2620	2864	2945			
N	No Caster	2419	2464	2509	2554	2600	2644	2689	2734	2779		2620	2864	2945			
		Back															
		COM	COL	Gr.1	Gr.2	Gr.3	Gr.4	Gr.5	Gr.6	Gr.7	Gr.8	Gr.9	Gr.10	Gr.11			
C	Caster	0	116	70	101	128	159	182	201	220	244	267	290	317			
N	No Caster	0	116	70	101	128	159	182	201	220	244	267	290	317			
													Leather				
		Gr.12	Gr.13	Gr.14	Gr.15	Gr.16	Gr.17	Gr.18	Gr.19	Gr.20		LB	LC	LD			
C	Caster	348	386	426	464	502	542	580	618	658		534	742	812			
N	No Caster	348	386	426	464	502	542	580	618	658		534	742	812			

STGH cesto pouf with back, fabric base

Product Options

Style	Seat Pad Upholstery Finish	Back Upholstery Finish	Base Upholstery Finish
C Caster	Fabric	Fabric	Fabric
N No Caster	Leather	Leather	Leather



		Seat												
		COM	COL	Gr.1	Gr.2	Gr.3	Gr.4	Gr.5	Gr.6	Gr.7	Gr.8	Gr.9	Gr.10	Gr.11
C	Caster	2065	2189	2146	2182	2213	2249	2277	2299	2322	2349	2376	2404	2435
N	No Caster	2065	2189	2146	2182	2213	2249	2277	2299	2322	2349	2376	2404	2435
		Leather												
		Gr.12	Gr.13	Gr.14	Gr.15	Gr.16	Gr.17	Gr.18	Gr.19	Gr.20	LB	LC	LD	
C	Caster	2471	2516	2561	2607	2652	2696	2741	2786	2832	2676	2920	3001	
N	No Caster	2471	2516	2561	2607	2652	2696	2741	2786	2832	2676	2920	3001	
		Back												
		COM	COL	Gr.1	Gr.2	Gr.3	Gr.4	Gr.5	Gr.6	Gr.7	Gr.8	Gr.9	Gr.10	Gr.11
C	Caster	0	116	70	101	128	159	182	201	220	244	267	290	317
N	No Caster	0	116	70	101	128	159	182	201	220	244	267	290	317
		Leather												
		Gr.12	Gr.13	Gr.14	Gr.15	Gr.16	Gr.17	Gr.18	Gr.19	Gr.20	LB	LC	LD	
C	Caster	348	386	426	464	502	542	580	618	658	534	742	812	
N	No Caster	348	386	426	464	502	542	580	618	658	534	742	812	
		Base												
		COM	COL	Gr.1	Gr.2	Gr.3	Gr.4	Gr.5	Gr.6	Gr.7	Gr.8	Gr.9	Gr.10	Gr.11
C	Caster	0	116	93	135	171	211	242	268	293	325	356	386	422
N	No Caster	0	116	93	135	171	211	242	268	293	325	356	386	422
		Leather												
		Gr.12	Gr.13	Gr.14	Gr.15	Gr.16	Gr.17	Gr.18	Gr.19	Gr.20	LB	LC	LD	
C	Caster	464	515	567	618	670	722	774	825	877	673	951	1044	
N	No Caster	464	515	567	618	670	722	774	825	877	673	951	1044	

STGE cesto bench, knit base

Product Options

Style	Seat Pad Upholstery Finish	Knit Mesh Base Finish			
C Caster	Fabric	K413	Eggshell	K419	Goldenrod
N No Caster	Leather	K414	Stone	K420	Sunset
		K415	Khaki	K421	Cardinal
		K416	Silver	K422	Magenta
		K417	Taupe	K423	Cobalt
		K418	Graphite		

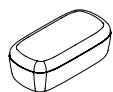

	Price												
	COM	COL	Gr.1	Gr.2	Gr.3	Gr.4	Gr.5	Gr.6	Gr.7	Gr.8	Gr.9	Gr.10	Gr.11
C Caster	2223	2356	2362	2423	2478	2539	2586	2625	2663	2710	2756	2803	2857
N No Caster	2223	2356	2362	2423	2478	2539	2586	2625	2663	2710	2756	2803	2857
											Leather		
	Gr.12	Gr.13	Gr.14	Gr.15	Gr.16	Gr.17	Gr.18	Gr.19	Gr.20	LB	LC	LD	
C Caster	2919	2996	3073	3151	3228	3305	3383	3460	3537	3191	3609	3748	
N No Caster	2919	2996	3073	3151	3228	3305	3383	3460	3537	3191	3609	3748	

STGF cesto bench, fabric base

Product Options

Style	Seat Pad Upholstery Finish	Base Upholstery Finish
C Caster	Fabric	Fabric
N No Caster	Leather	Leather

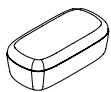

	Seat												
	COM	COL	Gr.1	Gr.2	Gr.3	Gr.4	Gr.5	Gr.6	Gr.7	Gr.8	Gr.9	Gr.10	Gr.11
C Caster	2275	2412	2414	2475	2530	2591	2638	2677	2716	2762	2808	2855	2909
N No Caster	2275	2412	2414	2475	2530	2591	2638	2677	2716	2762	2808	2855	2909
											Leather		
	Gr.12	Gr.13	Gr.14	Gr.15	Gr.16	Gr.17	Gr.18	Gr.19	Gr.20	LB	LC	LD	
C Caster	2971	3048	3125	3203	3280	3357	3435	3512	3589	3247	3664	3804	
N No Caster	2971	3048	3125	3203	3280	3357	3435	3512	3589	3247	3664	3804	
	Base												
	COM	COL	Gr.1	Gr.2	Gr.3	Gr.4	Gr.5	Gr.6	Gr.7	Gr.8	Gr.9	Gr.10	Gr.11
C Caster	0	116	139	201	255	317	363	403	441	487	534	580	635
N No Caster	0	116	139	201	255	317	363	403	441	487	534	580	635
											Leather		
	Gr.12	Gr.13	Gr.14	Gr.15	Gr.16	Gr.17	Gr.18	Gr.19	Gr.20	LB	LC	LD	
C Caster	696	774	850	928	1006	1082	1160	1238	1314	951	1369	1508	
N No Caster	696	774	850	928	1006	1082	1160	1238	1314	951	1369	1508	

STGJ cesto bench with back, knit base

Product Options

Style	Seat Pad Upholstery Finish	Back Upholstery Finish	Knit Mesh Base Finish
C Caster	Fabric	Fabric	K413 Eggshell
N No Caster	Leather	Leather	K414 Stone
			K415 Khaki
			K416 Silver
			K417 Taupe
			K418 Graphite
			K419 Goldenrod
			K420 Sunset
			K421 Cardinal
			K422 Magenta
			K423 Cobalt

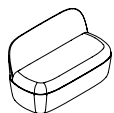

	Seat												
	COM	COL	Gr.1	Gr.2	Gr.3	Gr.4	Gr.5	Gr.6	Gr.7	Gr.8	Gr.9	Gr.10	Gr.11
C Caster	3088	3274	3227	3289	3343	3405	3451	3490	3529	3575	3622	3668	3722
N No Caster	3088	3274	3227	3289	3343	3405	3451	3490	3529	3575	3622	3668	3722
											Leather		
											LB	LC	LD
C Caster	3784	3862	3938	4016	4094	4170	4248	4326	4402		4109	4526	4666
N No Caster	3784	3862	3938	4016	4094	4170	4248	4326	4402		4109	4526	4666
	Back												
	COM	COL	Gr.1	Gr.2	Gr.3	Gr.4	Gr.5	Gr.6	Gr.7	Gr.8	Gr.9	Gr.10	Gr.11
C Caster	0	116	128	184	234	291	333	369	404	447	490	531	581
N No Caster	0	116	128	184	234	291	333	369	404	447	490	531	581
											Leather		
											LB	LC	LD
C Caster	638	709	780	850	921	993	1064	1134	1205		882	1264	1392
N No Caster	638	709	780	850	921	993	1064	1134	1205		882	1264	1392

STGK cesto bench with back, fabric base

Product Options

Style	Seat Pad Upholstery Finish	Back Upholstery Finish	Base Upholstery Finish
C Caster	Fabric	Fabric	Fabric
N No Caster	Leather	Leather	Leather

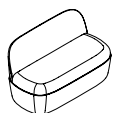

		Seat												
		COM	COL	Gr.1	Gr.2	Gr.3	Gr.4	Gr.5	Gr.6	Gr.7	Gr.8	Gr.9	Gr.10	Gr.11
C	Caster	3140	3329	3279	3341	3395	3457	3503	3543	3581	3627	3674	3720	3775
N	No Caster	3140	3329	3279	3341	3395	3457	3503	3543	3581	3627	3674	3720	3775
												Leather		
		Gr.12	Gr.13	Gr.14	Gr.15	Gr.16	Gr.17	Gr.18	Gr.19	Gr.20	LB	LC	LD	
C	Caster	3836	3914	3990	4068	4146	4222	4300	4378	4454	4164	4582	4721	
N	No Caster	3836	3914	3990	4068	4146	4222	4300	4378	4454	4164	4582	4721	
		Back												
		COM	COL	Gr.1	Gr.2	Gr.3	Gr.4	Gr.5	Gr.6	Gr.7	Gr.8	Gr.9	Gr.10	Gr.11
C	Caster	0	116	128	184	234	291	333	369	404	447	490	531	581
N	No Caster	0	116	128	184	234	291	333	369	404	447	490	531	581
												Leather		
		Gr.12	Gr.13	Gr.14	Gr.15	Gr.16	Gr.17	Gr.18	Gr.19	Gr.20	LB	LC	LD	
C	Caster	638	709	780	850	921	993	1064	1134	1205	882	1264	1392	
N	No Caster	638	709	780	850	921	993	1064	1134	1205	882	1264	1392	
		Base												
		COM	COL	Gr.1	Gr.2	Gr.3	Gr.4	Gr.5	Gr.6	Gr.7	Gr.8	Gr.9	Gr.10	Gr.11
C	Caster	0	116	139	201	255	317	363	403	441	487	534	580	635
N	No Caster	0	116	139	201	255	317	363	403	441	487	534	580	635
												Leather		
		Gr.12	Gr.13	Gr.14	Gr.15	Gr.16	Gr.17	Gr.18	Gr.19	Gr.20	LB	LC	LD	
C	Caster	696	774	850	928	1006	1082	1160	1238	1314	951	1369	1508	
N	No Caster	696	774	850	928	1006	1082	1160	1238	1314	951	1369	1508	

clip

features

Clip is a versatile seating option designed by the Swedish architectural partnership Claesson Koivisto Rune.

Clip was inspired by the common hair band used on the head. Visually, it creates the curvature of the back with the clip. Designed for Studio TK, the chair's rounded aesthetic is accentuated by crisp, clean stitching. Clip features a wide range of colors that can create a beautiful hospitality-type moment with the use of a more neutral color, or a more iconic moment with an interesting pop of color.

Clip can be specified in five-star caster, four-leg in metal, four-leg in wood, and in pedestal cross-base options to suit a host of commercial settings. Bases are finished in polished and painted aluminum, as well as in a hard-wood option.

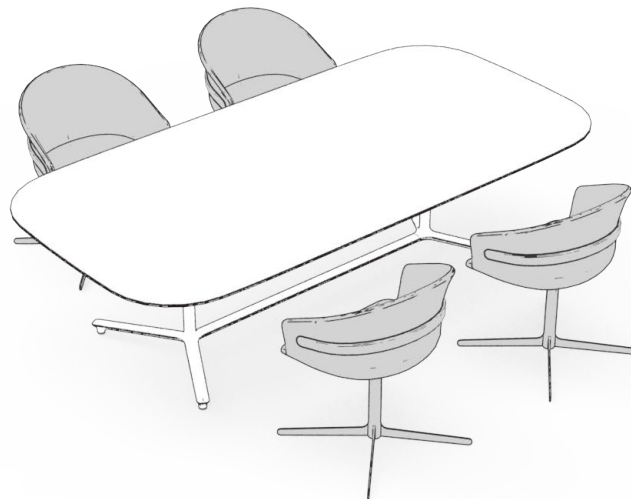

dimensions

- Designed and tested for users up to 300 lbs
- Meets ANSI/BIFMA requirements

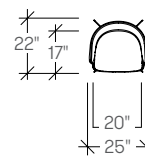
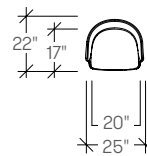
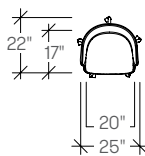
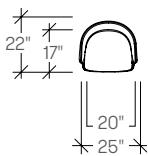

Clip Chair, Four Leg
(STJL)

Clip Chair, Five Star Task
(STJT)

Clip Chair,
Wood Four Leg
(STJW)

Clip Chair, Four Star Swivel
(STJS)

clip

planning

A variety of configurations can be achieved with Clip, allowing for various configurations. The following typical demonstrate the versatility that can be achieved.

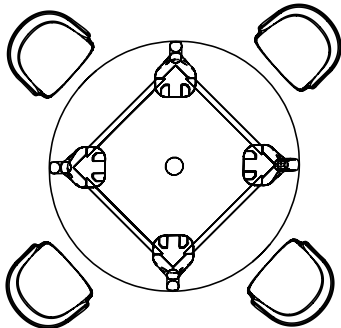
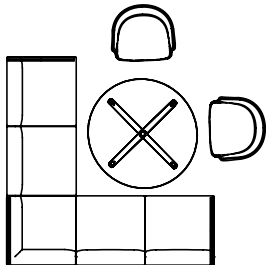
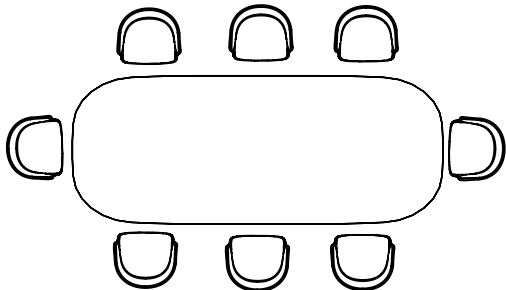
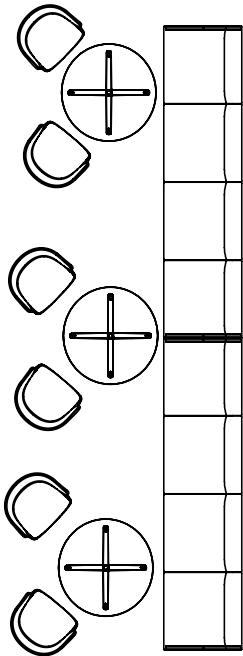
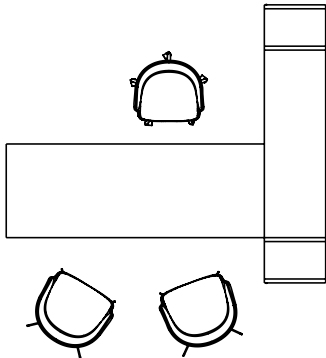
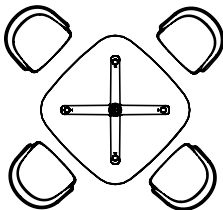
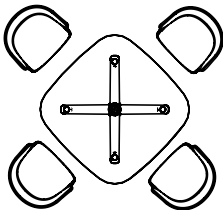

specifying clip finishes

The modularity of Clip permits a wide range of fabric combinations that allows for an expressive use of color, texture and material.

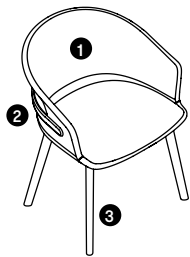

- 1 Seat Upholstery**
Select the seat upholstery
- 2 Band Finish**
Select the band finish
- 3 Base Finish**
Select base finish

specification example

STJL Clip Chair, Four Leg		
1	Seat fabric, Gr.5	2025
2	Band finish, Fundamental	0
3	Base finish, Fundamental	0
Total:		\$2025

STJS Clip Chair, Four Star Swivel		
1	Seat fabric, Gr.5	2202
2	Band finish, Fundamental	0
3	Base finish, Fundamental	0
Total:		\$2202

STJL Clip Chair, Four Leg		
1	Seat fabric, Gr.5	2025
2	Band finish, Fashion	64
3	Base finish, Fundamental	0
Total:		\$2089

STJS Clip Chair, Four Star Swivel		
1	Seat fabric, Gr.5	2202
2	Band finish, Fashion	64
3	Base finish, Fundamental	0
Total:		\$2265

STJL Clip Chair, Four Leg		
1	Seat fabric, Gr.5	2025
2	Band finish, Fashion	64
3	Base finish, Fashion	64
Total:		\$2153

STJS Clip Chair, Four Star Swivel		
1	Seat fabric, Gr.5	2202
2	Band finish, Fashion	64
3	Base finish, Fashion	64
Total:		\$2329

weights

Clip Chair, Four Leg	29 - 34 lbs
Clip Chair, Five-Star Task	32 - 37 lbs
Clip Chair, Wood Leg	27 - 32 lbs
Clip Chair, Four-Star Swivel	30 - 35 lbs

COM/COL material requirement

Yardage is based on a non-patterned fabric. Additional yardage may be required for pattern repeats and the matching required. Leather yield may be affected by the quality of the COL. However, variance in the size of the hides will not affect the yield.

SINGLE UPHOLSTERY	COM [yards]	COL [sq. ft.]
Chair	3 1/4	59

clique

features

The Clique Bench series configures to today's diverse office landscape. It is an agile seating system that acts as a perimeter bench program or as a freestanding, soft collaborative bench for impromptu meetings. With the ability to pair 29" high worktables allows Clique to be used in a traditional work height setting with a lifestyle approach. The variation of back styles and two leg options allows for countless applications where no two spaces look the same.



Clique benches consist of the following styles.

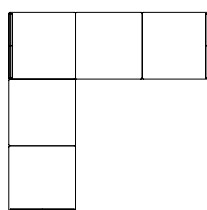

Five-Seat Bench,
Left No Back
(shown)

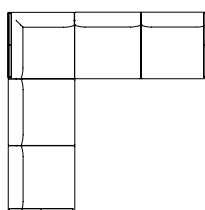

Five-Seat Bench,
Left Full Back
(shown)

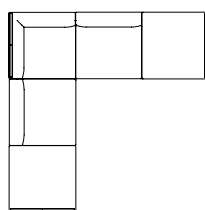

Five-Seat Bench,
Left Full Back with
Open Run-Off
(shown)

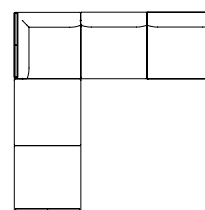

Five-Seat Bench,
Left Full Back with
Open Ends
(shown)

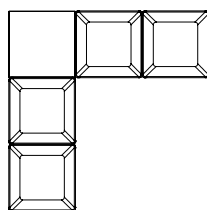

Five-Seat Bench,
with Table, No Back
(shown)

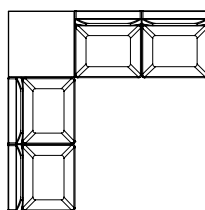

Five-Seat Bench,
with Table, Full Back
(shown)

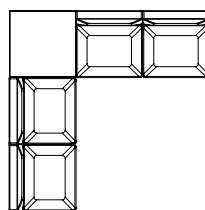

Five-Seat Bench,
with Table, Full
Back, Right Run-Off
(shown)

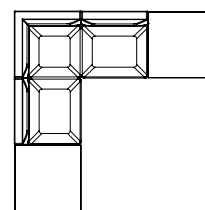

Five-Seat Bench,
with Table, Full Back
with Open Ends
(shown)

clique

planning

A variety of configurations can be achieved with Clique benches. The following typical demonstrate the versatility that can be achieved.

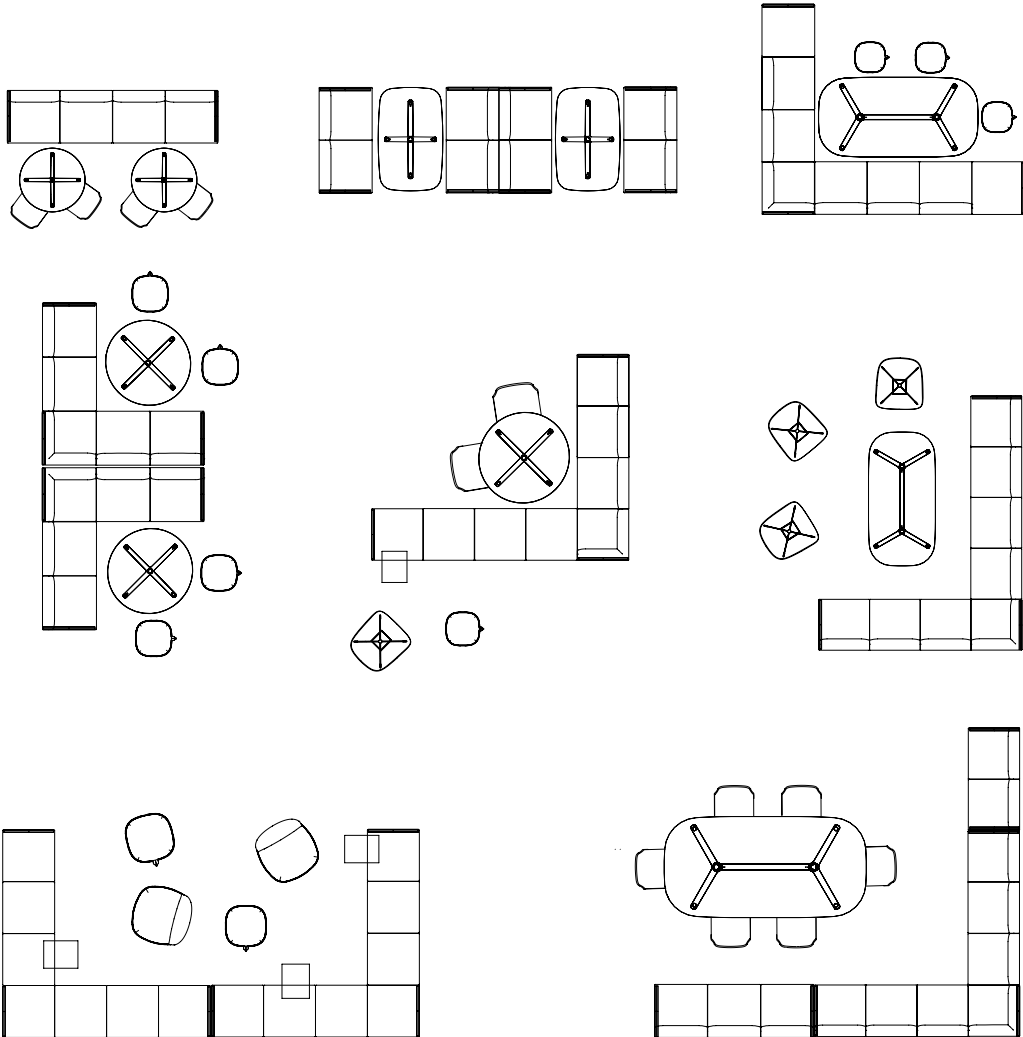

dimensions

- Designed and tested for users up to 300 lbs
- Meets ANSI/BIFMA requirements

Recommended use with a 29" high table.

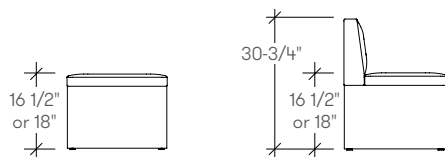

16 1/2" for the table top surface or 18" seat height for upholstered seat pad.

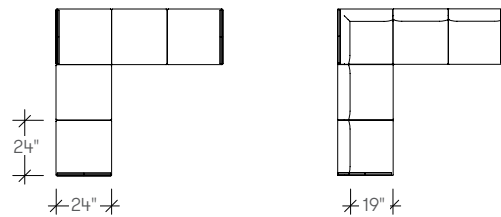

clique

The following outlines the overall dimensions of each Clique bench.

Bench

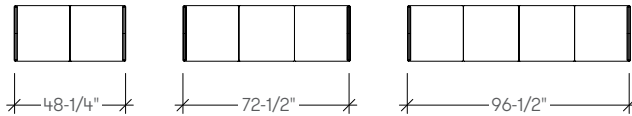

Two-Seat Bench,
No Back
(STP2A)

Three-Seat Bench,
No Back
(STP3A)

Four-Seat Bench,
No Back
(STP4A)

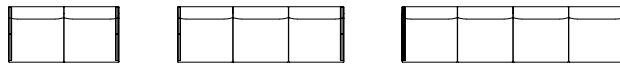

Two-Seat Bench,
With Back
(STP2B)

Three-Seat Bench,
With Back
(STP3B)

Four-Seat Bench,
With Back
(STP4B)

Five-Seat Bench and Five-Seat Bench with Table

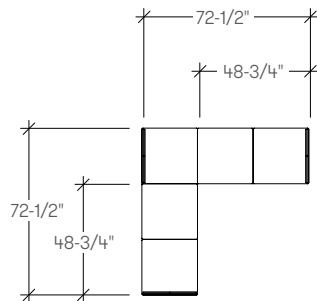

Five-Seat Bench,
Left No Back
(STP5C)

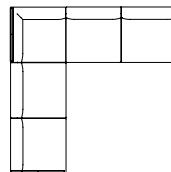

Five-Seat Bench,
Left Full Back
(STP5D)

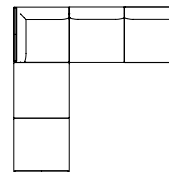

Five-Seat Bench, Left Full
Back with Open Run-Off
(STP5E)

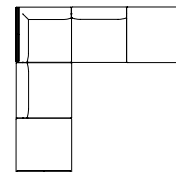

Five-Seat Bench, Left Full
Back with Open Ends
(STP5F)

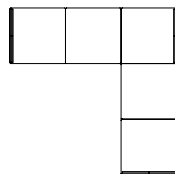

Five-Seat Bench,
Right No Back
(STP5G)

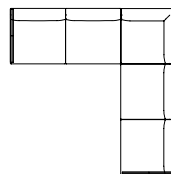

Five-Seat Bench,
Right Full Back
(STP5H)

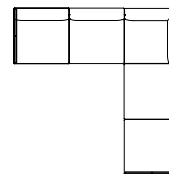

Five-Seat Bench, Right Full
Back with Open Run-Off
(STP5J)

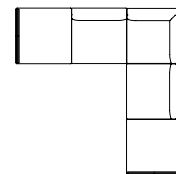

Five-Seat Bench, Right Full
Back with Open Ends
(STP5K)

clique

The following outlines the overall dimensions of each Clique bench.

Six-Seat Bench and Six-Seat Bench with Table

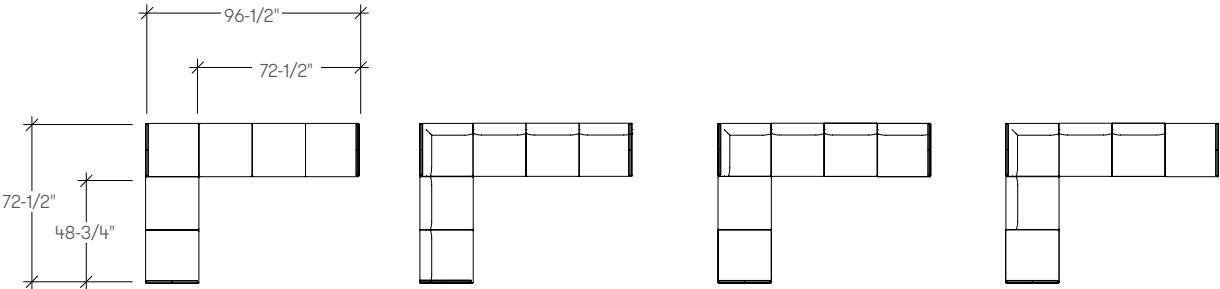

Six-Seat Bench, Left No Back (STP6C)

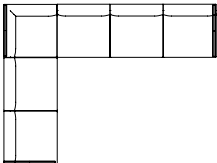

Six-Seat Bench, Left Full Back (STP6D)

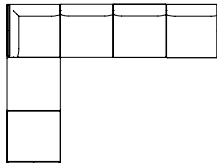

Six-Seat Bench, Left Full Back with Open Run-Off (STP6E)

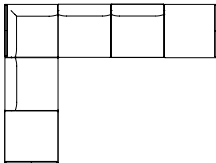

Six-Seat Bench, Left Full Back with Open Ends (STP6F)

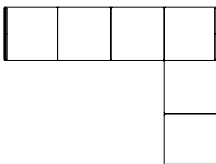

Six-Seat Bench, Right No Back (STP6G)

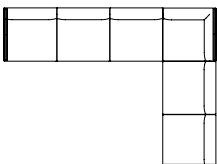

Six-Seat Bench, Right Full Back (STP6H)

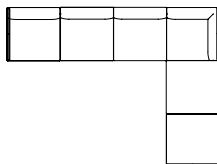

Six-Seat Bench, Right Full Back with Open Run-Off (STP6J)

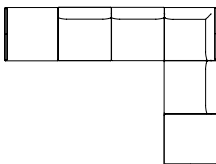

Six-Seat Bench, Right Full Back with Open Ends (STP6K)

Seven-Seat Bench and Seven-Seat Bench with Table

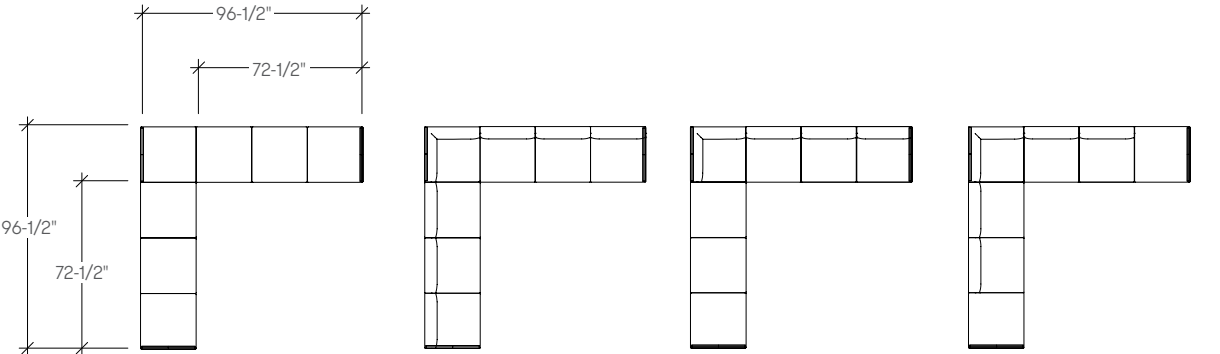

Seven-Seat Bench, Left No Back (STP7C)

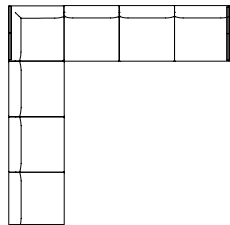

Seven-Seat Bench, Left Full Back (STP7D)

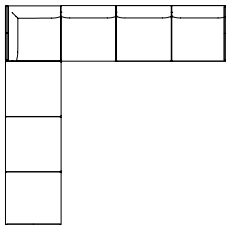

Seven-Seat Bench, Left Full Back with Open Run-Off (STP7E)

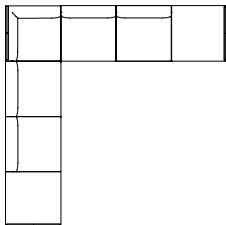

Seven-Seat Bench, Left Full Back with Open Ends (STP7F)

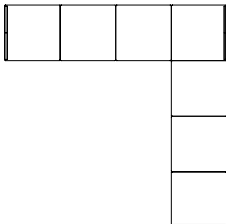

Seven-Seat Bench, Right No Back (STP7G)

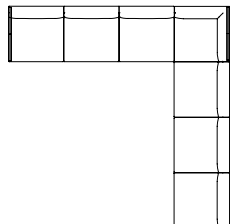

Seven-Seat Bench, Right Full Back (STP7H)

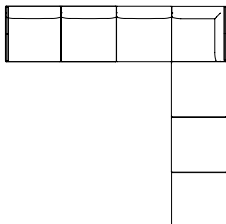

Seven-Seat Bench, Right Full Back with Open Run-Off (STP7J)

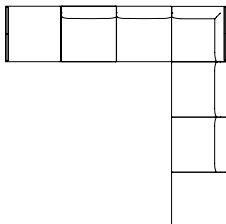

Seven-Seat Bench, Right Full Back with Open Ends (STP7K)

clique

The following outlines the overall dimensions of each Clique bench.

Eight-Seat Bench and Eight-Seat Bench with Table

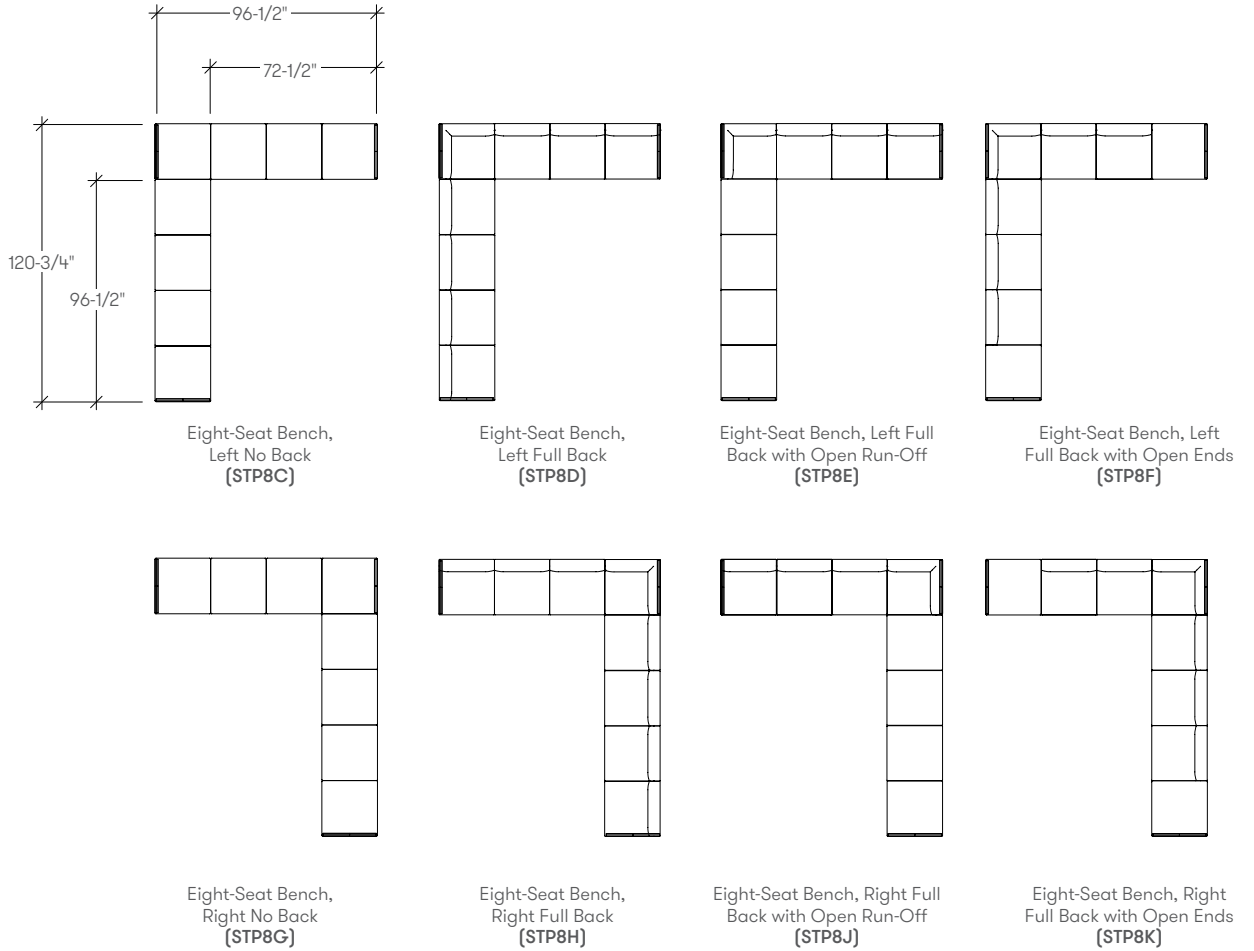

clique details

The Parallel leg is the leg on the primary bench and the perpendicular leg is on the run off. The orientation of a bench is determined by the location of the parallel and perpendicular legs. Units can be placed side-by-side to create a large 'U' shaped lounge spaces.

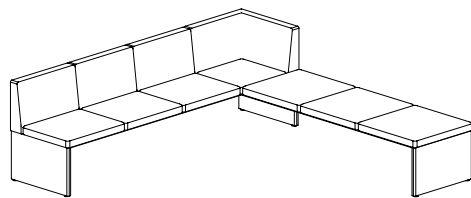

right orientation

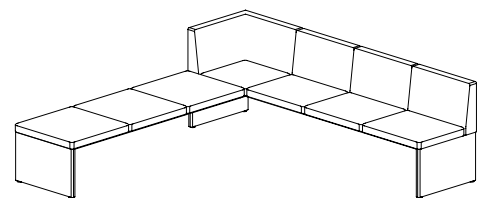

left orientation

specifying clique finishes

Cliques modularity provides a wide range of fabric combinations which allow for an expressive use of color, texture and material.

The following outlines the specification process for Clique fabric selections.

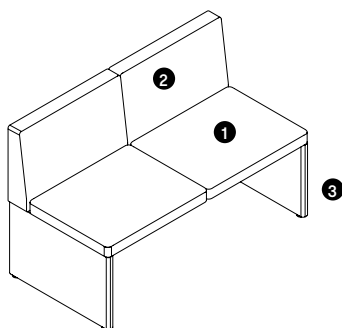

- 1 **Seat Upholstery**
Select the seat upholstery
- 2 **Back Upholstery**
Select the back upholstery
- 3 **Base Style and Finish**
Select the Metal or Upholstered Base and its corresponding finish

Two leg styles are available on Clique to provide various aesthetics.

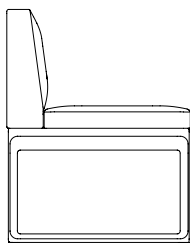

metal leg

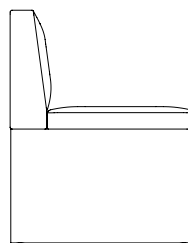

upholstered leg

clique power accessories

Power can be accepted on any bench style and placed in any set of holes desired by the user. Power accessory is sold separately.

Power can be routed on the underside of the bench with magnetic cable managers to the nearest leg or power monument.

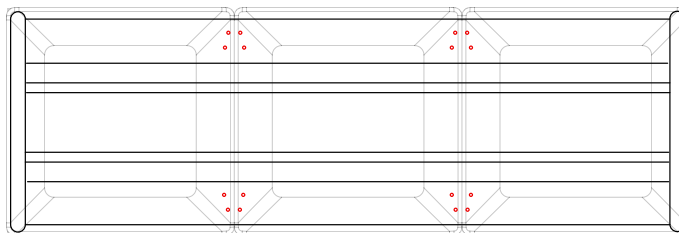

Power can be attached between any seat and on either side of the bench, as well for all configurations of the bench.

specification example

STP2AU Clique Bench, Two-Seat, No Back, Upholstered Leg		
①	Seat Fabric Gr. 3	2777
②	Leg Finish Gr. 5	303
Total:		\$3080

STP4BU Clique Bench, Four-Seat, with Back, Upholstered Leg		
①	Seat Fabric Gr. 5	6129
②	Back Fabric Gr. 3	426
③	Leg Finish Gr. 2	167
Total:		\$6722

STP4BM Clique Bench, Four-Seat, with Back, Metal Leg		
①	Seat Fabric Gr. 5	5743
②	Back Fabric Gr. 3	426
Total:		\$6169

STP6JU Clique Bench, Full Back with Open Runoff, Right, Upholstered Leg		
①	Seat Fabric Gr. 3	8605
②	Back Fabric Gr. 7	919
③	Leg Finish Gr. 5	455
Total:		\$9978

STP8FM Clique Bench, Full Back with Open Ends, Left, Metal Leg		
①	Seat Fabric Gr. 8	10876
②	Back Fabric Gr. 3	745
Total:		\$11621

COM/COL material requirement

Yardage is based on a non-patterned fabric. Additional yardage may be required for pattern repeats and the matching required. Leather yield may be affected by the quality of the COL. However, variance in the size of the hides will not affect the yield.

CLIQUE		COM [yards]	COL [sq. ft.]
Two-Seat Bench	Seats	2 1/2	45
	Backs	2 1/2	45
	Optional Upholstered Leg	2 1/2	45
Three-Seat Bench	Seats	3 3/4	67 1/2
	Backs	3 3/4	67 1/2
	Optional Upholstered Leg	2 1/2	45
Four-Seat Bench	Seats	5	90
	Backs	5	90
	Optional Upholstered Leg	2 1/2	45
Five-Seat Bench	Seats	6 1/4	112 1/2
	Backs - Full	7 1/2	135
	Backs - Open End and Run-Off	5	90
	Optional Upholstered Leg	3 3/4	67 1/2
Six-Seat Bench	Seats	7 1/2	135
	Backs - Full	8 3/4	157 1/2
	Backs - Open End and Run-Off	6 1/4	112 1/2
	Optional Upholstered Leg	3 3/4	67 1/2
Seven-Seat Bench	Seats	8 3/4	157 1/2
	Backs - Full	10	180
	Backs - Open End and Run-Off	7 1/2	135
	Optional Upholstered Leg	3 3/4	67 1/2
Eight-Seat Bench	Seats	10	180
	Backs - Full	11 1/4	202 1/2
	Backs - Open End and Run-Off	8 3/4	157 1/2
	Optional Upholstered Leg	3 3/4	67 1/2
Five-Seat Bench with Table	Seats - Corner Table	5	90
	Seats - End Tables	3 3/4	68
	Backs - Full	5	90
	Optional Upholstered Leg	3 3/4	68
Six-Seat Bench with Table	Seats - Corner Table	6 1/4	113
	Seats - End Tables	5	90
	Backs - Full	6 1/4	113
	Optional Upholstered Leg	3 3/4	68
Seven-Seat Bench with Table	Seats - Corner Table	7 1/2	135
	Seats - End Tables	6 1/4	113
	Backs - Full	7 1/2	135
	Optional Upholstered Leg	3 3/4	68
Eight-Seat Bench with Table	Seats - Corner Table	8 3/4	158
	Seats - End Tables	7 1/2	135
	Backs - Full	8 3/4	158
	Optional Upholstered Leg	3 3/4	68

*If a metal leg is selected the Optional Upholstered Leg yardage is not applicable

**Yardages listed are totals for all backs and seats. Total yardage of 'Full Back' and 'Open Ends & Runoffs' are for separate products. They should not be added together.

STP2A clique two-seat bench, no back

Product Options

Leg Style	Seat Upholstery	Leg Finish
U Upholstered	Fabric	Fabric
M Metal	Leather	Leather
		C9 Polished Aluminum
		Fundamental Paint
		Fashion Paint

Note For Polished Aluminum, add \$0
 For Fundamental Paint, add \$174
 For Fashion Paint, add \$290



		Seat												
		COM	COL	Gr.1	Gr.2	Gr.3	Gr.4	Gr.5	Gr.6	Gr.7	Gr.8	Gr.9	Gr.10	Gr.11
M	Metal	2181	2312	2297	2348	2393	2445	2484	2516	2549	2587	2625	2665	2710
U	Upholstered	2565	2719	2681	2732	2777	2829	2868	2900	2932	2971	3009	3048	3094
												Leather		
		Gr.12	Gr.13	Gr.14	Gr.15	Gr.16	Gr.17	Gr.18	Gr.19	Gr.20	LB	LC	LD	
M	Metal	2761	2826	2890	2955	3018	3083	3147	3212	3276	3008	3356	3472	
U	Upholstered	3145	3210	3274	3338	3402	3467	3531	3596	3660	3415	3763	3879	
		Leg												
		COM	COL	Gr.1	Gr.2	Gr.3	Gr.4	Gr.5	Gr.6	Gr.7	Gr.8	Gr.9	Gr.10	Gr.11
M	Metal	n/a	n/a	n/a	n/a	n/a	n/a	n/a	n/a	n/a	n/a	n/a	n/a	n/a
U	Upholstered	0	116	116	167	212	264	303	335	368	406	444	484	529
												Leather		
		Gr.12	Gr.13	Gr.14	Gr.15	Gr.16	Gr.17	Gr.18	Gr.19	Gr.20	LB	LC	LD	
M	Metal	n/a	n/a	n/a	n/a	n/a	n/a	n/a	n/a	n/a	n/a	n/a	n/a	
U	Upholstered	580	645	709	774	838	902	1031	1031	1095	812	1160	1276	

STP2B clique two-seat bench, with back

Product Options

Leg Style	Seat Upholstery	Back Upholstery	Leg Finish
U Upholstered	Fabric	Fabric	Fabric
M Metal	Leather	Leather	Leather
			C9 Polished Aluminum
			Fundamental Paint
			Fashion Paint

Note For Polished Aluminum, add \$0
 For Fundamental Paint, add \$174
 For Fashion Paint, add \$290

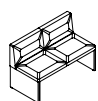

		Seat												
		COM	COL	Gr.1	Gr.2	Gr.3	Gr.4	Gr.5	Gr.6	Gr.7	Gr.8	Gr.9	Gr.10	Gr.11
M	Metal	3080	3265	3196	3247	3292	3344	3383	3415	3448	3486	3524	3564	3609
U	Upholstered	3465	3674	3581	3632	3677	3729	3768	3800	3833	3871	3909	3949	3994
												Leather		
		Gr.12	Gr.13	Gr.14	Gr.15	Gr.16	Gr.17	Gr.18	Gr.19	Gr.20	LB	LC	LD	
M	Metal	3660	3725	3789	3854	3917	3982	4046	4111	4175	3961	4309	4425	
U	Upholstered	4045	4110	4174	4239	4302	4367	4431	4496	4560	4370	4718	4834	
		Back												
		COM	COL	Gr.1	Gr.2	Gr.3	Gr.4	Gr.5	Gr.6	Gr.7	Gr.8	Gr.9	Gr.10	Gr.11
M	Metal	0	116	116	167	212	264	303	335	368	406	444	484	529
U	Upholstered	0	116	116	167	212	264	303	335	368	406	444	484	529
												Leather		
		Gr.12	Gr.13	Gr.14	Gr.15	Gr.16	Gr.17	Gr.18	Gr.19	Gr.20	LB	LC	LD	
M	Metal	580	645	709	774	838	902	966	1031	1095	812	1160	1276	
U	Upholstered	580	645	709	774	838	902	966	1031	1095	812	1160	1276	
		Leg												
		COM	COL	Gr.1	Gr.2	Gr.3	Gr.4	Gr.5	Gr.6	Gr.7	Gr.8	Gr.9	Gr.10	Gr.11
M	Metal	n/a	n/a	n/a	n/a	n/a	n/a	n/a	n/a	n/a	n/a	n/a	n/a	n/a
U	Upholstered	0	116	116	167	212	264	303	335	368	406	444	484	529
												Leather		
		Gr.12	Gr.13	Gr.14	Gr.15	Gr.16	Gr.17	Gr.18	Gr.19	Gr.20	LB	LC	LD	
M	Metal	n/a	n/a	n/a	n/a	n/a	n/a	n/a	n/a	n/a	n/a	n/a	n/a	
U	Upholstered	580	645	709	774	838	902	1031	1031	1095	812	1160	1276	

STP3A clique three-seat bench, no back

Product Options

Leg Style	Seat Upholstery	Leg Finish
U Upholstered	Fabric	Fabric
M Metal	Leather	Leather
		C9 Polished Aluminum
		Fundamental Paint
		Fashion Paint

Note For Polished Aluminum, add \$0
 For Fundamental Paint, add \$174
 For Fashion Paint, add \$290

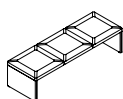

		Seat												
		COM	COL	Gr.1	Gr.2	Gr.3	Gr.4	Gr.5	Gr.6	Gr.7	Gr.8	Gr.9	Gr.10	Gr.11
M	Metal	2565	2719	2739	2816	2884	2961	3019	3067	3116	3174	3232	3290	3357
U	Upholstered	2951	3129	3125	3203	3270	3348	3406	3453	3502	3560	3618	3676	3743
												Leather		
		Gr.12	Gr.13	Gr.14	Gr.15	Gr.16	Gr.17	Gr.18	Gr.19	Gr.20	LB	LC	LD	
M	Metal	3435	3531	3628	3725	3821	3918	4015	4111	4208	3771	4297	4472	
U	Upholstered	3821	3917	4015	4111	4207	4305	4401	4497	4595	4181	4706	4881	
		Leg												
		COM	COL	Gr.1	Gr.2	Gr.3	Gr.4	Gr.5	Gr.6	Gr.7	Gr.8	Gr.9	Gr.10	Gr.11
M	Metal	n/a	n/a	n/a	n/a	n/a	n/a	n/a	n/a	n/a	n/a	n/a	n/a	n/a
U	Upholstered	0	116	116	167	212	264	303	335	368	406	444	484	529
												Leather		
		Gr.12	Gr.13	Gr.14	Gr.15	Gr.16	Gr.17	Gr.18	Gr.19	Gr.20	LB	LC	LD	
M	Metal	n/a	n/a	n/a	n/a	n/a	n/a	n/a	n/a	n/a	n/a	n/a	n/a	
U	Upholstered	580	645	709	774	838	902	1031	1031	1095	812	1160	1276	

STP3B clique three-seat bench, with back

Product Options

Leg Style	Seat Upholstery	Back Upholstery	Leg Finish
U Upholstered	Fabric	Fabric	Fabric
M Metal	Leather	Leather	Leather
			C9 Polished Aluminum
			Fundamental Paint
			Fashion Paint

Note For Polished Aluminum, add \$0
 For Fundamental Paint, add \$174
 For Fashion Paint, add \$290

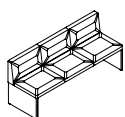

		Seat												
		COM	COL	Gr.1	Gr.2	Gr.3	Gr.4	Gr.5	Gr.6	Gr.7	Gr.8	Gr.9	Gr.10	Gr.11
M	Metal	4237	4493	4411	4489	4556	4634	4692	4740	4788	4846	4904	4962	5030
U	Upholstered	4624	4902	4798	4875	4943	5020	5078	5126	5175	5233	5291	5349	5416
		Leather												
		Gr.12	Gr.13	Gr.14	Gr.15	Gr.16	Gr.17	Gr.18	Gr.19	Gr.20	LB	LC	LD	
M	Metal	5107	5204	5301	5397	5494	5591	5687	5784	5881	5545	6070	6245	
U	Upholstered	5494	5590	5687	5784	5880	5977	6074	6170	6267	5954	6480	6655	
		Back												
		COM	COL	Gr.1	Gr.2	Gr.3	Gr.4	Gr.5	Gr.6	Gr.7	Gr.8	Gr.9	Gr.10	Gr.11
M	Metal	0	116	174	252	319	397	455	502	551	609	667	725	792
U	Upholstered	0	116	174	252	319	397	455	502	551	609	667	725	792
		Leather												
		Gr.12	Gr.13	Gr.14	Gr.15	Gr.16	Gr.17	Gr.18	Gr.19	Gr.20	LB	LC	LD	
M	Metal	870	966	1064	1160	1256	1354	1450	1546	1644	1168	1694	1869	
U	Upholstered	870	966	1064	1160	1256	1354	1450	1546	1644	1168	1694	1869	
		Leg												
		COM	COL	Gr.1	Gr.2	Gr.3	Gr.4	Gr.5	Gr.6	Gr.7	Gr.8	Gr.9	Gr.10	Gr.11
M	Metal	n/a	n/a	n/a	n/a	n/a	n/a	n/a	n/a	n/a	n/a	n/a	n/a	n/a
U	Upholstered	0	116	116	167	212	264	303	335	368	406	444	484	529
		Leather												
		Gr.12	Gr.13	Gr.14	Gr.15	Gr.16	Gr.17	Gr.18	Gr.19	Gr.20	LB	LC	LD	
M	Metal	n/a	n/a	n/a	n/a	n/a	n/a	n/a	n/a	n/a	n/a	n/a	n/a	
U	Upholstered	580	645	709	774	838	902	1031	1031	1095	812	1160	1276	

STP4A clique four-seat bench, no back

Product Options

Leg Style	Seat Upholstery	Leg Finish
U Upholstered	Fabric	Fabric
M Metal	Leather	Leather
		C9 Polished Aluminum
		Fundamental Paint
		Fashion Paint

Note For Polished Aluminum, add \$0
 For Fundamental Paint, add \$174
 For Fashion Paint, add \$290

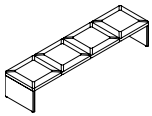

		Seat												
		COM	COL	Gr.1	Gr.2	Gr.3	Gr.4	Gr.5	Gr.6	Gr.7	Gr.8	Gr.9	Gr.10	Gr.11
M	Metal	2951	3129	3183	3286	3377	3480	3557	3622	3685	3763	3841	3917	4008
U	Upholstered	3337	3538	3569	3673	3763	3866	3943	4008	4072	4149	4227	4304	4394
												Leather		
		Gr.12	Gr.13	Gr.14	Gr.15	Gr.16	Gr.17	Gr.18	Gr.19	Gr.20	LB	LC	LD	
M	Metal	4111	4240	4369	4497	4626	4756	4885	5014	5142	4521	5217	5449	
U	Upholstered	4497	4626	4755	4884	5012	5142	5271	5400	5529	4930	5626	5858	
		Leg												
		COM	COL	Gr.1	Gr.2	Gr.3	Gr.4	Gr.5	Gr.6	Gr.7	Gr.8	Gr.9	Gr.10	Gr.11
M	Metal	n/a	n/a	n/a	n/a	n/a	n/a	n/a	n/a	n/a	n/a	n/a	n/a	n/a
U	Upholstered	0	116	116	167	212	264	303	335	368	406	444	484	529
												Leather		
		Gr.12	Gr.13	Gr.14	Gr.15	Gr.16	Gr.17	Gr.18	Gr.19	Gr.20	LB	LC	LD	
M	Metal	n/a	n/a	n/a	n/a	n/a	n/a	n/a	n/a	n/a	n/a	n/a	n/a	
U	Upholstered	580	645	709	774	838	902	1031	1031	1095	812	1160	1276	

STP4B clique four-seat bench, with back

Product Options

Leg Style	Seat Upholstery	Back Upholstery	Leg Finish
U Upholstered	Fabric	Fabric	Fabric
M Metal	Leather	Leather	Leather
			C9 Polished Aluminum
			Fundamental Paint
			Fashion Paint

Note For Polished Aluminum, add \$0
 For Fundamental Paint, add \$174
 For Fashion Paint, add \$290

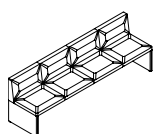

		Seat														
		COM	COL	Gr.1	Gr.2	Gr.3	Gr.4	Gr.5	Gr.6	Gr.7	Gr.8	Gr.9	Gr.10	Gr.11		
M	Metal	5138	5446	5370	5473	5563	5667	5743	5808	5872	5950	6027	6104	6194		
U	Upholstered	5524	5856	5756	5859	5950	6053	6129	6194	6258	6336	6414	6490	6581		
												Leather				
		Gr.12	Gr.13	Gr.14	Gr.15	Gr.16	Gr.17	Gr.18	Gr.19	Gr.20	LB	LC	LD			
M	Metal	6298	6426	6555	6684	6813	6943	7071	7200	7329	7458	7586	7715	6838	7534	7766
U	Upholstered	6684	6813	6941	7070	7199	7329	7458	7586	7715				7248	7944	8176
		Back														
		COM	COL	Gr.1	Gr.2	Gr.3	Gr.4	Gr.5	Gr.6	Gr.7	Gr.8	Gr.9	Gr.10	Gr.11		
M	Metal	0	116	232	335	426	529	606	670	734	812	890	966	1057		
U	Upholstered	0	116	232	335	426	529	606	670	734	812	890	966	1057		
												Leather				
		Gr.12	Gr.13	Gr.14	Gr.15	Gr.16	Gr.17	Gr.18	Gr.19	Gr.20	LB	LC	LD			
M	Metal	1160	1289	1418	1546	1675	1805	1934	2062	2191				1508	2204	2436
U	Upholstered	1160	1289	1418	1546	1675	1805	1934	2062	2191				1508	2204	2436
		Leg														
		COM	COL	Gr.1	Gr.2	Gr.3	Gr.4	Gr.5	Gr.6	Gr.7	Gr.8	Gr.9	Gr.10	Gr.11		
M	Metal	n/a	n/a	n/a	n/a	n/a	n/a	n/a	n/a	n/a	n/a	n/a	n/a	n/a		
U	Upholstered	0	116	116	167	212	264	303	335	368	406	444	484	529		
												Leather				
		Gr.12	Gr.13	Gr.14	Gr.15	Gr.16	Gr.17	Gr.18	Gr.19	Gr.20	LB	LC	LD			
M	Metal	n/a	n/a	n/a	n/a	n/a	n/a	n/a	n/a	n/a				n/a	n/a	n/a
U	Upholstered	580	645	709	774	838	902	1031	1031	1095				812	1160	1276

STP5C clique five-seat bench, left no back

Product Options

Leg Style	Seat Upholstery	Leg Finish
U Upholstered	Fabric	Fabric
M Metal	Leather	Leather
		C9 Polished Aluminum
		Fundamental Paint
		Fashion Paint

Note For Polished Aluminum, add \$0
 For Fundamental Paint, add \$174
 For Fashion Paint, add \$290

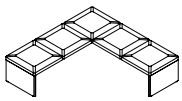

		Seat															
		COM	COL	Gr.1	Gr.2	Gr.3	Gr.4	Gr.5	Gr.6	Gr.7	Gr.8	Gr.9	Gr.10	Gr.11			
M	Metal	4751	5037	5041	5170	5283	5411	5509	5589	5670	5766	5863	5960	6073			
U	Upholstered	5138	5446	5428	5556	5669	5798	5895	5975	6056	6153	6249	6346	6459			
												Leather					
		Gr.12	Gr.13	Gr.14	Gr.15	Gr.16	Gr.17	Gr.18	Gr.19	Gr.20	LB	LC	LD				
M	Metal	6201	6363	6524	6685	6846	7006	7168	7329	7490	6785	7658	7949				
U	Upholstered	6588	6749	6910	7071	7233	7393	7554	7715	7876	7194	8068	8359				
		Leg															
		COM	COL	Gr.1	Gr.2	Gr.3	Gr.4	Gr.5	Gr.6	Gr.7	Gr.8	Gr.9	Gr.10	Gr.11			
M	Metal	n/a	n/a	n/a	n/a	n/a	n/a	n/a	n/a	n/a	n/a	n/a	n/a	n/a			
U	Upholstered	0	116	174	252	319	397	455	502	551	609	667	725	792			
												Leather					
		Gr.12	Gr.13	Gr.14	Gr.15	Gr.16	Gr.17	Gr.18	Gr.19	Gr.20	LB	LC	LD				
M	Metal	n/a	n/a	n/a	n/a	n/a	n/a	n/a	n/a	n/a	n/a	n/a	n/a				
U	Upholstered	870	966	1064	1160	1256	1354	1546	1546	1644	812	1160	1276				

STP5D clique five-seat bench, left full back

Product Options

Leg Style	Seat Upholstery	Back Upholstery	Leg Finish
U Upholstered	Fabric	Fabric	Fabric
M Metal	Leather	Leather	Leather
			C9 Polished Aluminum
			Fundamental Paint
			Fashion Paint

Note For Polished Aluminum, add \$0
 For Fundamental Paint, add \$174
 For Fashion Paint, add \$290

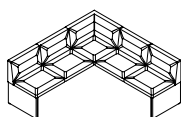

		Seat												
		COM	COL	Gr.1	Gr.2	Gr.3	Gr.4	Gr.5	Gr.6	Gr.7	Gr.8	Gr.9	Gr.10	Gr.11
M	Metal	7967	8446	8257	8386	8498	8627	8724	8804	8886	8982	9078	9176	9288
U	Upholstered	8352	8854	8642	8771	8883	9012	9109	9190	9271	9367	9463	9561	9673
												Leather		
		Gr.12	Gr.13	Gr.14	Gr.15	Gr.16	Gr.17	Gr.18	Gr.19	Gr.20	LB	LC	LD	
M	Metal	9417	9578	9739	9901	10062	10222	10383	10544	10706	10194	11068	11359	
U	Upholstered	9802	9963	10124	10286	10447	10607	10768	10930	11091	10602	11476	11767	
		Back												
		COM	COL	Gr.1	Gr.2	Gr.3	Gr.4	Gr.5	Gr.6	Gr.7	Gr.8	Gr.9	Gr.10	Gr.11
M	Metal	0	116	348	502	638	792	908	1006	1102	1218	1334	1450	1586
U	Upholstered	0	116	348	502	638	792	908	1006	1102	1218	1334	1450	1586
												Leather		
		Gr.12	Gr.13	Gr.14	Gr.15	Gr.16	Gr.17	Gr.18	Gr.19	Gr.20	LB	LC	LD	
M	Metal	1740	1934	2126	2320	2514	2706	2900	3094	3286	2204	3248	3596	
U	Upholstered	1740	1934	2126	2320	2514	2706	2900	3094	3286	2204	3248	3596	
		Leg												
		COM	COL	Gr.1	Gr.2	Gr.3	Gr.4	Gr.5	Gr.6	Gr.7	Gr.8	Gr.9	Gr.10	Gr.11
M	Metal	n/a	n/a	n/a	n/a	n/a	n/a	n/a	n/a	n/a	n/a	n/a	n/a	n/a
U	Upholstered	0	116	174	252	319	397	455	502	551	609	667	725	792
												Leather		
		Gr.12	Gr.13	Gr.14	Gr.15	Gr.16	Gr.17	Gr.18	Gr.19	Gr.20	LB	LC	LD	
M	Metal	n/a	n/a	n/a	n/a	n/a	n/a	n/a	n/a	n/a	n/a	n/a	n/a	
U	Upholstered	870	966	1064	1160	1256	1354	1546	1546	1644	1168	1694	1869	

STP5E clique five-seat bench, left full back with open run-off

Product Options

Leg Style	Seat Upholstery	Back Upholstery	Leg Finish
U Upholstered	Fabric	Fabric	Fabric
M Metal	Leather	Leather	Leather
			C9 Polished Aluminum
			Fundamental Paint
			Fashion Paint

Note For Polished Aluminum, add \$0
 For Fundamental Paint, add \$174
 For Fashion Paint, add \$290

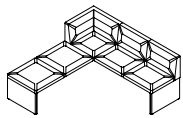

		Seat												
		COM	COL	Gr.1	Gr.2	Gr.3	Gr.4	Gr.5	Gr.6	Gr.7	Gr.8	Gr.9	Gr.10	Gr. 11
M	Metal	6809	7219	7099	7228	7340	7469	7567	7647	7728	7824	7920	8018	8130
U	Upholstered	7194	7627	7484	7613	7726	7854	7952	8032	8113	8209	8306	8403	8516
												Leather		
		Gr.12	Gr.13	Gr.14	Gr.15	Gr.16	Gr.17	Gr.18	Gr.19	Gr.20	LB	LC	LD	
M	Metal	8259	8420	8582	8743	8904	9064	9225	9387	9548	8967	9840	10131	
U	Upholstered	8644	8806	8967	9128	9289	9449	9611	9772	9933	9375	10249	10540	
		Back												
		COM	COL	Gr.1	Gr.2	Gr.3	Gr.4	Gr.5	Gr.6	Gr.7	Gr.8	Gr.9	Gr.10	Gr. 11
M	Metal	0	116	232	335	426	529	606	670	734	812	890	966	1057
U	Upholstered	0	116	232	335	426	529	606	670	734	812	890	966	1057
												Leather		
		Gr.12	Gr.13	Gr.14	Gr.15	Gr.16	Gr.17	Gr.18	Gr.19	Gr.20	LB	LC	LD	
M	Metal	1160	1289	1418	1546	1675	1805	1934	2062	2191	1508	2204	2436	
U	Upholstered	1160	1289	1418	1546	1675	1805	1934	2062	2191	1508	2204	2436	
		Leg												
		COM	COL	Gr.1	Gr.2	Gr.3	Gr.4	Gr.5	Gr.6	Gr.7	Gr.8	Gr.9	Gr.10	Gr. 11
M	Metal	n/a	n/a	n/a	n/a	n/a	n/a	n/a	n/a	n/a	n/a	n/a	n/a	n/a
U	Upholstered	0	116	174	252	319	397	455	502	551	609	667	725	792
												Leather		
		Gr.12	Gr.13	Gr.14	Gr.15	Gr.16	Gr.17	Gr.18	Gr.19	Gr.20	LB	LC	LD	
M	Metal	n/a	n/a	n/a	n/a	n/a	n/a	n/a	n/a	n/a	n/a	n/a	n/a	
U	Upholstered	870	966	1064	1160	1256	1354	1546	1546	1644	1168	1694	1869	

STP5F clique five-seat bench, left full back with open ends

Product Options

Leg Style	Seat Upholstery	Back Upholstery	Leg Finish
U Upholstered	Fabric	Fabric	Fabric
M Metal	Leather	Leather	Leather
			C9 Polished Aluminum
			Fundamental Paint
			Fashion Paint

Note For Polished Aluminum, add \$0
 For Fundamental Paint, add \$174
 For Fashion Paint, add \$290

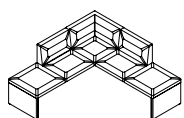

		Seat												
		COM	COL	Gr.1	Gr.2	Gr.3	Gr.4	Gr.5	Gr.6	Gr.7	Gr.8	Gr.9	Gr.10	Gr.11
M	Metal	6938	7356	7228	7357	7469	7598	7695	7775	7857	7953	8049	8147	8259
U	Upholstered	7324	7765	7614	7743	7856	7984	8082	8162	8243	8339	8436	8533	8645
		Leather												
		Gr.12	Gr.13	Gr.14	Gr.15	Gr.16	Gr.17	Gr.18	Gr.19	Gr.20	LB	LC	LD	
M	Metal	8388	8549	8710	8872	9033	9193	9354	9515	9677	9104	9977	10268	
U	Upholstered	8774	8935	9097	9258	9419	9579	9741	9902	10063	9513	10387	10678	
		Back												
		COM	COL	Gr.1	Gr.2	Gr.3	Gr.4	Gr.5	Gr.6	Gr.7	Gr.8	Gr.9	Gr.10	Gr.11
M	Metal	0	116	232	335	426	529	606	670	734	812	890	966	1057
U	Upholstered	0	116	232	335	426	529	606	670	734	812	890	966	1057
		Leather												
		Gr.12	Gr.13	Gr.14	Gr.15	Gr.16	Gr.17	Gr.18	Gr.19	Gr.20	LB	LC	LD	
M	Metal	1160	1289	1418	1546	1675	1805	1934	2062	2191	1508	2204	2436	
U	Upholstered	1160	1289	1418	1546	1675	1805	1934	2062	2191	1508	2204	2436	
		Leg												
		COM	COL	Gr.1	Gr.2	Gr.3	Gr.4	Gr.5	Gr.6	Gr.7	Gr.8	Gr.9	Gr.10	Gr.11
M	Metal	n/a	n/a	n/a	n/a	n/a	n/a	n/a	n/a	n/a	n/a	n/a	n/a	n/a
U	Upholstered	0	116	174	252	319	397	455	502	551	609	667	725	792
		Leather												
		Gr.12	Gr.13	Gr.14	Gr.15	Gr.16	Gr.17	Gr.18	Gr.19	Gr.20	LB	LC	LD	
M	Metal	n/a	n/a	n/a	n/a	n/a	n/a	n/a	n/a	n/a	n/a	n/a	n/a	
U	Upholstered	870	966	1064	1160	1256	1354	1546	1546	1644	1168	1694	1869	

STP5G clique five-seat bench, right no back

Product Options

Leg Style	Seat Upholstery	Leg Finish
U Upholstered	Fabric	Fabric
M Metal	Leather	Leather
		C9 Polished Aluminum
		Fundamental Paint
		Fashion Paint

Note For Polished Aluminum, add \$0
 For Fundamental Paint, add \$174
 For Fashion Paint, add \$290

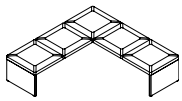

		Seat												
		COM	COL	Gr.1	Gr.2	Gr.3	Gr.4	Gr.5	Gr.6	Gr.7	Gr.8	Gr.9	Gr.10	Gr.11
M	Metal	4751	5037	5041	5170	5283	5411	5509	5589	5670	5766	5863	5960	6073
U	Upholstered	5138	5446	5428	5556	5669	5798	5895	5975	6056	6153	6249	6346	6459
		Gr.12	Gr.13	Gr.14	Gr.15	Gr.16	Gr.17	Gr.18	Gr.19	Gr.20	Leather			
											LB	LC	LD	
M	Metal	6201	6363	6524	6685	6846	7006	7168	7329	7490	6785	7658	7949	
U	Upholstered	6588	6749	6910	7071	7233	7393	7554	7715	7876	7194	8068	8359	
		Leg												
		COM	COL	Gr.1	Gr.2	Gr.3	Gr.4	Gr.5	Gr.6	Gr.7	Gr.8	Gr.9	Gr.10	Gr.11
M	Metal	n/a	n/a	n/a	n/a	n/a	n/a	n/a	n/a	n/a	n/a	n/a	n/a	n/a
U	Upholstered	0	116	174	252	319	397	455	502	551	609	667	725	792
		Gr.12	Gr.13	Gr.14	Gr.15	Gr.16	Gr.17	Gr.18	Gr.19	Gr.20	Leather			
											LB	LC	LD	
M	Metal	n/a	n/a	n/a	n/a	n/a	n/a	n/a	n/a	n/a	n/a	n/a	n/a	
U	Upholstered	870	966	1064	1160	1256	1354	1546	1546	1644	1168	1694	1869	

STP5H clique five-seat bench, right full back

Product Options

Leg Style	Seat Upholstery	Back Upholstery	Leg Finish
U Upholstered	Fabric	Fabric	Fabric
M Metal	Leather	Leather	Leather
			C9 Polished Aluminum
			Fundamental Paint
			Fashion Paint

Note For Polished Aluminum, add \$0
 For Fundamental Paint, add \$174
 For Fashion Paint, add \$290

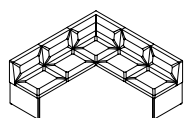

		Seat															
		COM	COL	Gr.1	Gr.2	Gr.3	Gr.4	Gr.5	Gr.6	Gr.7	Gr.8	Gr.9	Gr.10	Gr.11			
M	Metal	7967	8446	8257	8386	8498	8627	8724	8804	8886	8982	9078	9176	9288			
U	Upholstered	8352	8854	8642	8771	8883	9012	9109	9190	9271	9367	9463	9561	9673			
													Leather				
													LB	LC	LD		
M	Metal	9417	9578	9739	9901	10062	10222	10383	10544	10706		10194	11068	11359			
U	Upholstered	9802	9963	10124	10286	10447	10607	10768	10930	11091		10602	11476	11767			
		Back															
		COM	COL	Gr.1	Gr.2	Gr.3	Gr.4	Gr.5	Gr.6	Gr.7	Gr.8	Gr.9	Gr.10	Gr.11			
M	Metal	0	116	348	502	638	792	908	1006	1102	1218	1334	1450	1586			
U	Upholstered	0	116	348	502	638	792	908	1006	1102	1218	1334	1450	1586			
													Leather				
													LB	LC	LD		
M	Metal	1740	1934	2126	2320	2514	2706	2900	3094	3286		2204	3248	3596			
U	Upholstered	1740	1934	2126	2320	2514	2706	2900	3094	3286		2204	3248	3596			
		Leg															
		COM	COL	Gr.1	Gr.2	Gr.3	Gr.4	Gr.5	Gr.6	Gr.7	Gr.8	Gr.9	Gr.10	Gr.11			
M	Metal	n/a	n/a	n/a	n/a	n/a	n/a	n/a	n/a	n/a	n/a	n/a	n/a	n/a			
U	Upholstered	0	116	174	252	319	397	455	502	551	609	667	725	792			
													Leather				
													LB	LC	LD		
M	Metal	n/a	n/a	n/a	n/a	n/a	n/a	n/a	n/a	n/a	n/a	n/a	n/a	n/a			
U	Upholstered	870	966	1064	1160	1256	1354	1546	1546	1644		1168	1694	1869			

STP5J clique five-seat bench, right full back with open run-off

Product Options

Leg Style	Seat Upholstery	Back Upholstery	Leg Finish
U Upholstered	Fabric	Fabric	Fabric
M Metal	Leather	Leather	Leather
			C9 Polished Aluminum
			Fundamental Paint
			Fashion Paint

Note For Polished Aluminum, add \$0
 For Fundamental Paint, add \$174
 For Fashion Paint, add \$290

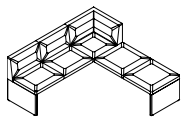

		Seat												
		COM	COL	Gr.1	Gr.2	Gr.3	Gr.4	Gr.5	Gr.6	Gr.7	Gr.8	Gr.9	Gr.10	Gr. 11
M	Metal	6809	7219	7099	7228	7340	7469	7567	7647	7728	7824	7920	8018	8130
U	Upholstered	7194	7627	7484	7613	7726	7854	7952	8032	8113	8209	8306	8403	8516
												Leather		
		Gr.12	Gr.13	Gr.14	Gr.15	Gr.16	Gr.17	Gr.18	Gr.19	Gr.20	LB	LC	LD	
M	Metal	8259	8420	8582	8743	8904	9064	9225	9387	9548	8967	9840	10131	
U	Upholstered	8644	8806	8967	9128	9289	9449	9611	9772	9933	9375	10249	10540	
		Back												
		COM	COL	Gr.1	Gr.2	Gr.3	Gr.4	Gr.5	Gr.6	Gr.7	Gr.8	Gr.9	Gr.10	Gr. 11
M	Metal	0	116	232	335	426	529	606	670	734	812	890	966	1057
U	Upholstered	0	116	232	335	426	529	606	670	734	812	890	966	1057
												Leather		
		Gr.12	Gr.13	Gr.14	Gr.15	Gr.16	Gr.17	Gr.18	Gr.19	Gr.20	LB	LC	LD	
M	Metal	1160	1289	1418	1546	1675	1805	1934	2062	2191	1508	2204	2436	
U	Upholstered	1160	1289	1418	1546	1675	1805	1934	2062	2191	1508	2204	2436	
		Leg												
		COM	COL	Gr.1	Gr.2	Gr.3	Gr.4	Gr.5	Gr.6	Gr.7	Gr.8	Gr.9	Gr.10	Gr. 11
M	Metal	n/a	n/a	n/a	n/a	n/a	n/a	n/a	n/a	n/a	n/a	n/a	n/a	n/a
U	Upholstered	0	116	174	252	319	397	455	502	551	609	667	725	792
												Leather		
		Gr.12	Gr.13	Gr.14	Gr.15	Gr.16	Gr.17	Gr.18	Gr.19	Gr.20	LB	LC	LD	
M	Metal	n/a	n/a	n/a	n/a	n/a	n/a	n/a	n/a	n/a	n/a	n/a	n/a	
U	Upholstered	870	966	1064	1160	1256	1354	1546	1546	1644	1168	1694	1869	

STP5K clique five-seat bench, right full back with open ends

Product Options

Leg Style	Seat Upholstery	Back Upholstery	Leg Finish
U Upholstered	Fabric	Fabric	Fabric
M Metal	Leather	Leather	Leather
			C9 Polished Aluminum
			Fundamental Paint
			Fashion Paint

Note For Polished Aluminum, add \$0
 For Fundamental Paint, add \$174
 For Fashion Paint, add \$290

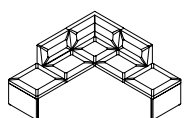

		Seat												
		COM	COL	Gr.1	Gr.2	Gr.3	Gr.4	Gr.5	Gr.6	Gr.7	Gr.8	Gr.9	Gr.10	Gr.11
M	Metal	6938	7356	7228	7357	7469	7598	7695	7775	7857	7953	8049	8147	8259
U	Upholstered	7324	7765	7614	7743	7856	7984	8082	8162	8243	8339	8436	8533	8645
		Leather												
		Gr.12	Gr.13	Gr.14	Gr.15	Gr.16	Gr.17	Gr.18	Gr.19	Gr.20	LB	LC	LD	
M	Metal	8388	8549	8710	8872	9033	9193	9354	9515	9677	9104	9977	10268	
U	Upholstered	8774	8935	9097	9258	9419	9579	9741	9902	10063	9513	10387	10678	
		Back												
		COM	COL	Gr.1	Gr.2	Gr.3	Gr.4	Gr.5	Gr.6	Gr.7	Gr.8	Gr.9	Gr.10	Gr.11
M	Metal	0	116	232	335	426	529	606	670	734	812	890	966	1057
U	Upholstered	0	116	232	335	426	529	606	670	734	812	890	966	1057
		Leather												
		Gr.12	Gr.13	Gr.14	Gr.15	Gr.16	Gr.17	Gr.18	Gr.19	Gr.20	LB	LC	LD	
M	Metal	1160	1289	1418	1546	1675	1805	1934	2062	2191	1508	2204	2436	
U	Upholstered	1160	1289	1418	1546	1675	1805	1934	2062	2191	1508	2204	2436	
		Leg												
		COM	COL	Gr.1	Gr.2	Gr.3	Gr.4	Gr.5	Gr.6	Gr.7	Gr.8	Gr.9	Gr.10	Gr.11
M	Metal	n/a	n/a	n/a	n/a	n/a	n/a	n/a	n/a	n/a	n/a	n/a	n/a	n/a
U	Upholstered	0	116	174	252	319	397	455	502	551	609	667	725	792
		Leather												
		Gr.12	Gr.13	Gr.14	Gr.15	Gr.16	Gr.17	Gr.18	Gr.19	Gr.20	LB	LC	LD	
M	Metal	n/a	n/a	n/a	n/a	n/a	n/a	n/a	n/a	n/a	n/a	n/a	n/a	
U	Upholstered	870	966	1064	1160	1256	1354	1546	1546	1644	1168	1694	1869	

STP6C clique six-seat bench, left no back

Product Options

Leg Style	Seat Upholstery	Leg Finish
U Upholstered	Fabric	Fabric
M Metal	Leather	Leather
		C9 Polished Aluminum
		Fundamental Paint
		Fashion Paint

Note For Polished Aluminum, add \$0
 For Fundamental Paint, add \$174
 For Fashion Paint, add \$290

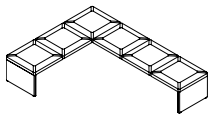

		Seat															
		COM	COL	Gr.1	Gr.2	Gr.3	Gr.4	Gr.5	Gr.6	Gr.7	Gr.8	Gr.9	Gr.10	Gr.11			
M	Metal	5524	5856	5872	6026	6162	6316	6432	6530	6626	6742	6858	6974	7110			
U	Upholstered	5909	6264	6257	6411	6547	6701	6817	6915	7011	7127	7243	7359	7495			
													Leather				
		Gr.12	Gr.13	Gr.14	Gr.15	Gr.16	Gr.17	Gr.18	Gr.19	Gr.20		LB	LC	LD			
M	Metal	7264	7458	7650	7844	8038	8230	8424	8618	8810		7944	8988	9336			
U	Upholstered	7649	7843	8035	8229	8423	8615	8809	9003	9195		8352	9396	9744			
		Leg															
		COM	COL	Gr.1	Gr.2	Gr.3	Gr.4	Gr.5	Gr.6	Gr.7	Gr.8	Gr.9	Gr.10	Gr.11			
M	Metal	n/a	n/a	n/a	n/a	n/a	n/a	n/a	n/a	n/a	n/a	n/a	n/a	n/a			
U	Upholstered	0	116	174	252	319	397	455	502	551	609	667	725	792			
													Leather				
		Gr.12	Gr.13	Gr.14	Gr.15	Gr.16	Gr.17	Gr.18	Gr.19	Gr.20		LB	LC	LD			
M	Metal	n/a	n/a	n/a	n/a	n/a	n/a	n/a	n/a	n/a		n/a	n/a	n/a			
U	Upholstered	870	966	1064	1160	1256	1354	1546	1546	1644		1168	1694	1869			

STP6D clique six-seat bench, left full back

Product Options

Leg Style	Seat Upholstery	Back Upholstery	Leg Finish
U Upholstered	Fabric	Fabric	Fabric
M Metal	Leather	Leather	Leather
			C9 Polished Aluminum
			Fundamental Paint
			Fashion Paint

Note For Polished Aluminum, add \$0
 For Fundamental Paint, add \$174
 For Fashion Paint, add \$290

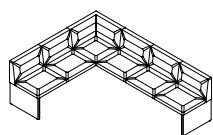

		Seat															
		COM	COL	Gr.1	Gr.2	Gr.3	Gr.4	Gr.5	Gr.6	Gr.7	Gr.8	Gr.9	Gr.10	Gr.11			
M	Metal	8738	9264	9086	9241	9376	9531	9647	9744	9840	9956	10072	10188	10324			
U	Upholstered	9125	9673	9473	9627	9763	9917	10033	10130	10227	10343	10459	10575	10710			
													Leather				
													LB	LC	LD		
M	Metal	10478	10672	10865	11058	11252	11445	11638	11832	12025		11352	12396	12744			
U	Upholstered	10865	11058	11251	11445	11638	11831	12025	12218	12411		11761	12805	13153			
		Back															
		COM	COL	Gr.1	Gr.2	Gr.3	Gr.4	Gr.5	Gr.6	Gr.7	Gr.8	Gr.9	Gr.10	Gr.11			
M	Metal	0	116	406	587	745	925	1060	1173	1285	1421	1557	1691	1849			
U	Upholstered	0	116	406	587	745	925	1060	1173	1285	1421	1557	1691	1849			
													Leather				
													LB	LC	LD		
M	Metal	2030	2255	2481	2706	2932	3158	3384	3609	3835		2560	3782	4189			
U	Upholstered	2030	2255	2481	2706	2932	3158	3384	3609	3835		2560	3782	4189			
		Leg															
		COM	COL	Gr.1	Gr.2	Gr.3	Gr.4	Gr.5	Gr.6	Gr.7	Gr.8	Gr.9	Gr.10	Gr.11			
M	Metal	n/a	n/a	n/a	n/a	n/a	n/a	n/a	n/a	n/a	n/a	n/a	n/a	n/a			
U	Upholstered	0	116	174	252	319	397	455	502	551	609	667	725	792			
													Leather				
													LB	LC	LD		
M	Metal	n/a	n/a	n/a	n/a	n/a	n/a	n/a	n/a	n/a	n/a	n/a	n/a	n/a			
U	Upholstered	870	966	1064	1160	1256	1354	1546	1546	1644		1168	1694	1869			

STP6E clique six-seat bench, left full back with open run-off

Product Options

Leg Style	Seat Upholstery	Back Upholstery	Leg Finish
U Upholstered	Fabric	Fabric	Fabric
M Metal	Leather	Leather	Leather
			C9 Polished Aluminum
			Fundamental Paint
			Fashion Paint

Note For Polished Aluminum, add \$0
 For Fundamental Paint, add \$174
 For Fashion Paint, add \$290

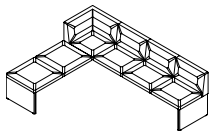

		Seat												
		COM	COL	Gr.1	Gr.2	Gr.3	Gr.4	Gr.5	Gr.6	Gr.7	Gr.8	Gr.9	Gr.10	Gr.11
M	Metal	7581	8036	7929	8083	8219	8373	8489	8586	8683	8799	8915	9031	9166
U	Upholstered	7967	8446	8315	8469	8605	8759	8875	8973	9069	9185	9301	9417	9553
												Leather		
		Gr.12	Gr.13	Gr.14	Gr.15	Gr.16	Gr.17	Gr.18	Gr.19	Gr.20	LB	LC	LD	
M	Metal	9321	9514	9707	9901	10094	10287	10481	10674	10867	10124	11168	11516	
U	Upholstered	9707	9901	10093	10287	10481	10673	10867	11061	11253	10534	11578	11926	
		Back												
		COM	COL	Gr.1	Gr.2	Gr.3	Gr.4	Gr.5	Gr.6	Gr.7	Gr.8	Gr.9	Gr.10	Gr.11
M	Metal	0	116	290	419	531	660	757	838	919	1015	1111	1209	1321
U	Upholstered	0	116	290	419	531	660	757	838	919	1015	1111	1209	1321
												Leather		
		Gr.12	Gr.13	Gr.14	Gr.15	Gr.16	Gr.17	Gr.18	Gr.19	Gr.20	LB	LC	LD	
M	Metal	1450	1611	1772	1934	2095	2255	2416	2578	2739	1864	2738	3029	
U	Upholstered	1450	1611	1772	1934	2095	2255	2416	2578	2739	1864	2738	3029	
		Leg												
		COM	COL	Gr.1	Gr.2	Gr.3	Gr.4	Gr.5	Gr.6	Gr.7	Gr.8	Gr.9	Gr.10	Gr.11
M	Metal	n/a	n/a	n/a	n/a	n/a	n/a	n/a	n/a	n/a	n/a	n/a	n/a	n/a
U	Upholstered	0	116	174	252	319	397	455	502	551	609	667	725	792
												Leather		
		Gr.12	Gr.13	Gr.14	Gr.15	Gr.16	Gr.17	Gr.18	Gr.19	Gr.20	LB	LC	LD	
M	Metal	n/a	n/a	n/a	n/a	n/a	n/a	n/a	n/a	n/a	n/a	n/a	n/a	
U	Upholstered	870	966	1064	1160	1256	1354	1546	1546	1644	1168	1694	1869	

STP6F clique six-seat bench, left full back with open ends

Product Options

Leg Style	Seat Upholstery	Back Upholstery	Leg Finish
U Upholstered	Fabric	Fabric	Fabric
M Metal	Leather	Leather	Leather
			C9 Polished Aluminum
			Fundamental Paint
			Fashion Paint

Note For Polished Aluminum, add \$0
 For Fundamental Paint, add \$174
 For Fashion Paint, add \$290

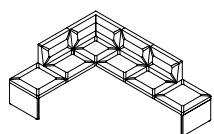

		Seat															
		COM	COL	Gr.1	Gr.2	Gr.3	Gr.4	Gr.5	Gr.6	Gr.7	Gr.8	Gr.9	Gr.10	Gr.11			
M	Metal	7708	8172	8056	8210	8346	8500	8616	8714	8810	8926	9042	9158	9294			
U	Upholstered	8094	8582	8442	8597	8732	8887	9003	9100	9196	9312	9428	9544	9680			
													Leather				
													LB	LC	LD		
M	Metal	9448	9642	9834	10028	10222	10414	10608	10802	10994		10260	11304	11652			
U	Upholstered	9834	10028	10221	10414	10608	10801	10994	11188	11381		10670	11714	12062			
		Back															
		COM	COL	Gr.1	Gr.2	Gr.3	Gr.4	Gr.5	Gr.6	Gr.7	Gr.8	Gr.9	Gr.10	Gr.11			
M	Metal	0	116	290	419	531	660	757	838	919	1015	1111	1209	1321			
U	Upholstered	0	116	290	419	531	660	757	838	919	1015	1111	1209	1321			
													Leather				
													LB	LC	LD		
M	Metal	1450	1611	1772	1934	2095	2255	2416	2578	2739		1864	2738	3029			
U	Upholstered	1450	1611	1772	1934	2095	2255	2416	2578	2739		1864	2738	3029			
		Leg															
		COM	COL	Gr.1	Gr.2	Gr.3	Gr.4	Gr.5	Gr.6	Gr.7	Gr.8	Gr.9	Gr.10	Gr.11			
M	Metal	n/a	n/a	n/a	n/a	n/a	n/a	n/a	n/a	n/a	n/a	n/a	n/a	n/a			
U	Upholstered	0	116	174	252	319	397	455	502	551	609	667	725	792			
													Leather				
													LB	LC	LD		
M	Metal	n/a	n/a	n/a	n/a	n/a	n/a	n/a	n/a	n/a	n/a	n/a	n/a	n/a			
U	Upholstered	870	966	1064	1160	1256	1354	1546	1546	1644		1168	1694	1869			

STP6G clique six-seat bench, right no back

Product Options

Leg Style	Seat Upholstery	Leg Finish
U Upholstered	Fabric	Fabric
M Metal	Leather	Leather
		C9 Polished Aluminum
		Fundamental Paint
		Fashion Paint

Note For Polished Aluminum, add \$0
 For Fundamental Paint, add \$174
 For Fashion Paint, add \$290

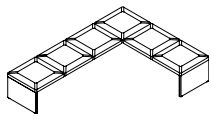

		Seat												
		COM	COL	Gr.1	Gr.2	Gr.3	Gr.4	Gr.5	Gr.6	Gr.7	Gr.8	Gr.9	Gr.10	Gr.11
M	Metal	5524	5856	5872	6026	6162	6316	6432	6530	6626	6742	6858	6974	7110
U	Upholstered	5909	6264	6257	6411	6547	6701	6817	6915	7011	7127	7243	7359	7495
												Leather		
		Gr.12	Gr.13	Gr.14	Gr.15	Gr.16	Gr.17	Gr.18	Gr.19	Gr.20	LB	LC	LD	
M	Metal	7264	7458	7650	7844	8038	8230	8424	8618	8810	7944	8988	9336	
U	Upholstered	7649	7843	8035	8229	8423	8615	8809	9003	9195	8352	9396	9744	
		Leg												
		COM	COL	Gr.1	Gr.2	Gr.3	Gr.4	Gr.5	Gr.6	Gr.7	Gr.8	Gr.9	Gr.10	Gr.11
M	Metal	n/a	n/a	n/a	n/a	n/a	n/a	n/a	n/a	n/a	n/a	n/a	n/a	n/a
U	Upholstered	0	116	174	252	319	397	455	502	551	609	667	725	792
												Leather		
		Gr.12	Gr.13	Gr.14	Gr.15	Gr.16	Gr.17	Gr.18	Gr.19	Gr.20	LB	LC	LD	
M	Metal	n/a	n/a	n/a	n/a	n/a	n/a	n/a	n/a	n/a	n/a	n/a	n/a	
U	Upholstered	870	966	1064	1160	1256	1354	1546	1546	1644	1168	1694	1869	

STP6H clique six-seat bench, right full back

Product Options

Leg Style	Seat Upholstery	Back Upholstery	Leg Finish
U Upholstered	Fabric	Fabric	Fabric
M Metal	Leather	Leather	Leather
			C9 Polished Aluminum
			Fundamental Paint
			Fashion Paint

Note For Polished Aluminum, add \$0
 For Fundamental Paint, add \$174
 For Fashion Paint, add \$290

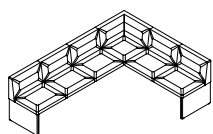

		Seat															
		COM	COL	Gr.1	Gr.2	Gr.3	Gr.4	Gr.5	Gr.6	Gr.7	Gr.8	Gr.9	Gr.10	Gr.11			
M	Metal	8738	9264	9086	9241	9376	9531	9647	9744	9840	9956	10072	10188	10324			
U	Upholstered	9125	9673	9473	9627	9763	9917	10033	10130	10227	10343	10459	10575	10710			
													Leather				
													LB	LC	LD		
M	Metal	10478	10672	10865	11058	11252	11445	11638	11832	12025			11352	12396	12744		
U	Upholstered	10865	11058	11251	11445	11638	11831	12025	12218	12411			11761	12805	13153		
		Back															
		COM	COL	Gr.1	Gr.2	Gr.3	Gr.4	Gr.5	Gr.6	Gr.7	Gr.8	Gr.9	Gr.10	Gr.11			
M	Metal	0	116	406	587	745	925	1060	1173	1285	1421	1557	1691	1849			
U	Upholstered	0	116	406	587	745	925	1060	1173	1285	1421	1557	1691	1849			
													Leather				
													LB	LC	LD		
M	Metal	2030	2255	2481	2706	2932	3158	3384	3609	3835			2560	3782	4189		
U	Upholstered	2030	2255	2481	2706	2932	3158	3384	3609	3835			2560	3782	4189		
		Leg															
		COM	COL	Gr.1	Gr.2	Gr.3	Gr.4	Gr.5	Gr.6	Gr.7	Gr.8	Gr.9	Gr.10	Gr.11			
M	Metal	n/a	n/a	n/a	n/a	n/a	n/a	n/a	n/a	n/a	n/a	n/a	n/a	n/a			
U	Upholstered	0	116	174	252	319	397	455	502	551	609	667	725	792			
													Leather				
													LB	LC	LD		
M	Metal	n/a	n/a	n/a	n/a	n/a	n/a	n/a	n/a	n/a	n/a	n/a	n/a	n/a			
U	Upholstered	870	966	1064	1160	1256	1354	1546	1546	1644			1168	1694	1869		

STP6J clique six-seat bench, right full back with open run-off

Product Options

Leg Style	Seat Upholstery	Back Upholstery	Leg Finish
U Upholstered	Fabric	Fabric	Fabric
M Metal	Leather	Leather	Leather
			C9 Polished Aluminum
			Fundamental Paint
			Fashion Paint

Note For Polished Aluminum, add \$0
 For Fundamental Paint, add \$174
 For Fashion Paint, add \$290

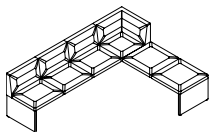

		Seat												
		COM	COL	Gr.1	Gr.2	Gr.3	Gr.4	Gr.5	Gr.6	Gr.7	Gr.8	Gr.9	Gr.10	Gr.11
M	Metal	7581	8036	7929	8083	8219	8373	8489	8586	8683	8799	8915	9031	9166
U	Upholstered	7967	8446	8315	8469	8605	8759	8875	8973	9069	9185	9301	9417	9553
												Leather		
		Gr.12	Gr.13	Gr.14	Gr.15	Gr.16	Gr.17	Gr.18	Gr.19	Gr.20	LB	LC	LD	
M	Metal	9321	9514	9707	9901	10094	10287	10481	10674	10867	10124	11168	11516	
U	Upholstered	9707	9901	10093	10287	10481	10673	10867	11061	11253	10534	11578	11926	
		Back												
		COM	COL	Gr.1	Gr.2	Gr.3	Gr.4	Gr.5	Gr.6	Gr.7	Gr.8	Gr.9	Gr.10	Gr.11
M	Metal	0	116	290	419	531	660	757	838	919	1015	1111	1209	1321
U	Upholstered	0	116	290	419	531	660	757	838	919	1015	1111	1209	1321
												Leather		
		Gr.12	Gr.13	Gr.14	Gr.15	Gr.16	Gr.17	Gr.18	Gr.19	Gr.20	LB	LC	LD	
M	Metal	2030	2255	2481	2706	2932	3158	3384	3609	3835	2560	3782	4189	
U	Upholstered	2030	2255	2481	2706	2932	3158	3384	3609	3835	2560	3782	4189	
		Leg												
		COM	COL	Gr.1	Gr.2	Gr.3	Gr.4	Gr.5	Gr.6	Gr.7	Gr.8	Gr.9	Gr.10	Gr.11
M	Metal	n/a	n/a	n/a	n/a	n/a	n/a	n/a	n/a	n/a	n/a	n/a	n/a	n/a
U	Upholstered	0	116	174	252	319	397	455	502	551	609	667	725	792
												Leather		
		Gr.12	Gr.13	Gr.14	Gr.15	Gr.16	Gr.17	Gr.18	Gr.19	Gr.20	LB	LC	LD	
M	Metal	n/a	n/a	n/a	n/a	n/a	n/a	n/a	n/a	n/a	n/a	n/a	n/a	
U	Upholstered	870	966	1064	1160	1256	1354	1546	1546	1644	1168	1694	1869	

STP6K clique six-seat bench, right full back with open ends

Product Options

Leg Style	Seat Upholstery	Back Upholstery	Leg Finish
U Upholstered	Fabric	Fabric	Fabric
M Metal	Leather	Leather	Leather
			C9 Polished Aluminum
			Fundamental Paint
			Fashion Paint

Note For Polished Aluminum, add \$0
 For Fundamental Paint, add \$174
 For Fashion Paint, add \$290

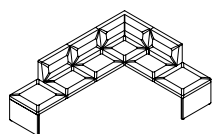

		Seat															
		COM	COL	Gr.1	Gr.2	Gr.3	Gr.4	Gr.5	Gr.6	Gr.7	Gr.8	Gr.9	Gr.10	Gr.11			
M	Metal	7708	8172	8056	8210	8346	8500	8616	8714	8810	8926	9042	9158	9294			
U	Upholstered	8094	8582	8442	8597	8732	8887	9003	9100	9196	9312	9428	9544	9680			
													Leather				
		Gr.12	Gr.13	Gr.14	Gr.15	Gr.16	Gr.17	Gr.18	Gr.19	Gr.20	LB	LC	LD				
M	Metal	9448	9642	9834	10028	10222	10414	10608	10802	10994	10260	11304	11652				
U	Upholstered	9834	10028	10221	10414	10608	10801	10994	11188	11381	10670	11714	12062				
		Back															
		COM	COL	Gr.1	Gr.2	Gr.3	Gr.4	Gr.5	Gr.6	Gr.7	Gr.8	Gr.9	Gr.10	Gr.11			
M	Metal	0	116	290	419	531	660	757	838	919	1015	1111	1209	1321			
U	Upholstered	0	116	290	419	531	660	757	838	919	1015	1111	1209	1321			
													Leather				
		Gr.12	Gr.13	Gr.14	Gr.15	Gr.16	Gr.17	Gr.18	Gr.19	Gr.20	LB	LC	LD				
M	Metal	2030	2255	2481	2706	2932	3158	3384	3609	3835	2560	3782	4189				
U	Upholstered	2030	2255	2481	2706	2932	3158	3384	3609	3835	2560	3782	4189				
		Leg															
		COM	COL	Gr.1	Gr.2	Gr.3	Gr.4	Gr.5	Gr.6	Gr.7	Gr.8	Gr.9	Gr.10	Gr.11			
M	Metal	n/a	n/a	n/a	n/a	n/a	n/a	n/a	n/a	n/a	n/a	n/a	n/a	n/a			
U	Upholstered	0	116	174	252	319	397	455	502	551	609	667	725	792			
													Leather				
		Gr.12	Gr.13	Gr.14	Gr.15	Gr.16	Gr.17	Gr.18	Gr.19	Gr.20	LB	LC	LD				
M	Metal	n/a	n/a	n/a	n/a	n/a	n/a	n/a	n/a	n/a	n/a	n/a	n/a				
U	Upholstered	870	966	1064	1160	1256	1354	1546	1546	1644	1168	1694	1869				

STP7C clique seven-seat bench, left no back

Product Options

Leg Style	Seat Upholstery	Leg Finish
U Upholstered	Fabric	Fabric
M Metal	Leather	Leather
		C9 Polished Aluminum
		Fundamental Paint
		Fashion Paint

Note For Polished Aluminum, add \$0
 For Fundamental Paint, add \$174
 For Fashion Paint, add \$290

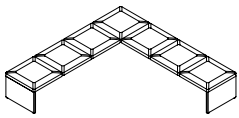

		Seat												
		COM	COL	Gr.1	Gr.2	Gr.3	Gr.4	Gr.5	Gr.6	Gr.7	Gr.8	Gr.9	Gr.10	Gr.11
M	Metal	6294	6672	6700	6881	7039	7219	7354	7467	7579	7715	7851	7985	8143
U	Upholstered	6680	7082	7086	7267	7425	7605	7741	7853	7966	8101	8237	8372	8529
		Gr.12	Gr.13	Gr.14	Gr.15	Gr.16	Gr.17	Gr.18	Gr.19	Gr.20	Leather			
											LB	LC	LD	
M	Metal	8324	8549	8775	9000	9227	9452	9678	9903	10129	9116	10338	10745	
U	Upholstered	8710	8935	9162	9387	9613	9838	10064	10289	10515	9526	10747	11155	
		Leg												
		COM	COL	Gr.1	Gr.2	Gr.3	Gr.4	Gr.5	Gr.6	Gr.7	Gr.8	Gr.9	Gr.10	Gr.11
M	Metal	n/a	n/a	n/a	n/a	n/a	n/a	n/a	n/a	n/a	n/a	n/a	n/a	n/a
U	Upholstered	0	116	174	252	319	397	455	502	551	609	667	725	792
		Gr.12	Gr.13	Gr.14	Gr.15	Gr.16	Gr.17	Gr.18	Gr.19	Gr.20	Leather			
											LB	LC	LD	
M	Metal	n/a	n/a	n/a	n/a	n/a	n/a	n/a	n/a	n/a	n/a	n/a	n/a	
U	Upholstered	870	966	1064	1160	1256	1354	1546	1546	1644	1168	1694	1869	

STP7D clique seven-seat bench, left full back

Product Options

Leg Style	Seat Upholstery	Back Upholstery	Leg Finish
U Upholstered	Fabric	Fabric	Fabric
M Metal	Leather	Leather	Leather
			C9 Polished Aluminum
			Fundamental Paint
			Fashion Paint

Note For Polished Aluminum, add \$0
 For Fundamental Paint, add \$174
 For Fashion Paint, add \$290

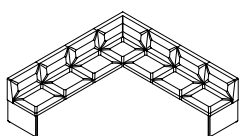

		Seat															
		COM	COL	Gr.1	Gr.2	Gr.3	Gr.4	Gr.5	Gr.6	Gr.7	Gr.8	Gr.9	Gr.10	Gr.11			
M	Metal	9509	10080	9915	10095	10253	10433	10569	10681	10794	10930	11065	11200	11358			
U	Upholstered	9895	10490	10301	10482	10640	10819	10955	11068	11180	11316	11452	11586	11744			
													Leather				
		Gr.12	Gr.13	Gr.14	Gr.15	Gr.16	Gr.17	Gr.18	Gr.19	Gr.20	LB	LC	LD				
M	Metal	11539	11764	11990	12215	12441	12666	12892	13117	13343	12525	13746	14153				
U	Upholstered	11925	12150	12376	12601	12827	13052	13279	13504	13730	12934	14155	14563				
		Back															
		COM	COL	Gr.1	Gr.2	Gr.3	Gr.4	Gr.5	Gr.6	Gr.7	Gr.8	Gr.9	Gr.10	Gr.11			
M	Metal	0	116	464	670	850	1057	1211	1341	1470	1624	1778	1934	2114			
U	Upholstered	0	116	464	670	850	1057	1211	1341	1470	1624	1778	1934	2114			
													Leather				
		Gr.12	Gr.13	Gr.14	Gr.15	Gr.16	Gr.17	Gr.18	Gr.19	Gr.20	LB	LC	LD				
M	Metal	2320	2578	2835	3094	3351	3609	3866	4125	4382	2900	4292	4756				
U	Upholstered	2320	2578	2835	3094	3351	3609	3866	4125	4382	2900	4292	4756				
		Leg															
		COM	COL	Gr.1	Gr.2	Gr.3	Gr.4	Gr.5	Gr.6	Gr.7	Gr.8	Gr.9	Gr.10	Gr.11			
M	Metal	n/a	n/a	n/a	n/a	n/a	n/a	n/a	n/a	n/a	n/a	n/a	n/a	n/a			
U	Upholstered	0	116	174	252	319	397	455	502	551	609	667	725	792			
													Leather				
		Gr.12	Gr.13	Gr.14	Gr.15	Gr.16	Gr.17	Gr.18	Gr.19	Gr.20	LB	LC	LD				
M	Metal	n/a	n/a	n/a	n/a	n/a	n/a	n/a	n/a	n/a	n/a	n/a	n/a				
U	Upholstered	870	966	1064	1160	1256	1354	1546	1546	1644	1168	1694	1869				

STP7E clique seven-seat bench, left full back with open run-off

Product Options

Leg Style	Seat Upholstery	Back Upholstery	Leg Finish
U Upholstered	Fabric	Fabric	Fabric
M Metal	Leather	Leather	Leather
			C9 Polished Aluminum
			Fundamental Paint
			Fashion Paint

Note For Polished Aluminum, add \$0
 For Fundamental Paint, add \$174
 For Fashion Paint, add \$290

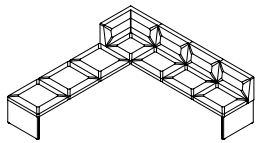

		Seat												
		COM	COL	Gr.1	Gr.2	Gr.3	Gr.4	Gr.5	Gr.6	Gr.7	Gr.8	Gr.9	Gr.10	Gr.11
M	Metal	8352	8854	8758	8939	9097	9277	9412	9525	9637	9773	9909	10043	10201
U	Upholstered	8738	9264	9144	9325	9483	9663	9799	9911	10024	10159	10295	10430	10587
												Leather		
		Gr.12	Gr.13	Gr.14	Gr.15	Gr.16	Gr.17	Gr.18	Gr.19	Gr.20	LB	LC	LD	
M	Metal	10382	10607	10833	11058	11284	11510	11736	11961	12187	11298	12520	12927	
U	Upholstered	10768	10993	11220	11445	11671	11896	12122	12347	12573	11708	12929	13337	
		Back												
		COM	COL	Gr.1	Gr.2	Gr.3	Gr.4	Gr.5	Gr.6	Gr.7	Gr.8	Gr.9	Gr.10	Gr.11
M	Metal	0	116	348	502	638	792	908	1006	1102	1218	1334	1450	1586
U	Upholstered	0	116	348	502	638	792	908	1006	1102	1218	1334	1450	1586
												Leather		
		Gr.12	Gr.13	Gr.14	Gr.15	Gr.16	Gr.17	Gr.18	Gr.19	Gr.20	LB	LC	LD	
M	Metal	1740	1934	2126	2320	2514	2706	2900	3094	3286	2204	3248	3596	
U	Upholstered	1740	1934	2126	2320	2514	2706	2900	3094	3286	2204	3248	3596	
		Leg												
		COM	COL	Gr.1	Gr.2	Gr.3	Gr.4	Gr.5	Gr.6	Gr.7	Gr.8	Gr.9	Gr.10	Gr.11
M	Metal	n/a	n/a	n/a	n/a	n/a	n/a	n/a	n/a	n/a	n/a	n/a	n/a	n/a
U	Upholstered	0	116	174	252	319	397	455	502	551	609	667	725	792
												Leather		
		Gr.12	Gr.13	Gr.14	Gr.15	Gr.16	Gr.17	Gr.18	Gr.19	Gr.20	LB	LC	LD	
M	Metal	n/a	n/a	n/a	n/a	n/a	n/a	n/a	n/a	n/a	n/a	n/a	n/a	
U	Upholstered	870	966	1064	1160	1256	1354	1546	1546	1644	1168	1694	1869	

STP7F clique seven-seat bench, left full back with open ends

Product Options

Leg Style	Seat Upholstery	Back Upholstery	Leg Finish
U Upholstered	Fabric	Fabric	Fabric
M Metal	Leather	Leather	Leather
			C9 Polished Aluminum
			Fundamental Paint
			Fashion Paint

Note For Polished Aluminum, add \$0
 For Fundamental Paint, add \$174
 For Fashion Paint, add \$290

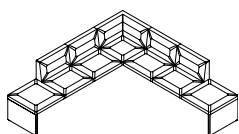

		Seat															
		COM	COL	Gr.1	Gr.2	Gr.3	Gr.4	Gr.5	Gr.6	Gr.7	Gr.8	Gr.9	Gr.10	Gr.11			
M	Metal	8481	8991	8887	9068	9225	9405	9541	9654	9766	9902	10037	10172	10330			
U	Upholstered	8867	9401	9273	9454	9612	9792	9927	10040	10152	10288	10424	10558	10716			
													Leather				
		Gr.12	Gr.13	Gr.14	Gr.15	Gr.16	Gr.17	Gr.18	Gr.19	Gr.20	Gr.8	Gr.9	Gr.10	Gr.11	LB	LC	LD
M	Metal	10511	10736	10962	11187	11413	11638	11864	12090	12316	11435	11657	11880	12106	11435	12657	13064
U	Upholstered	10897	11122	11348	11573	11800	12025	12251	12476	12702	11845	13066	13291	13516	11845	13066	13473
		Back															
		COM	COL	Gr.1	Gr.2	Gr.3	Gr.4	Gr.5	Gr.6	Gr.7	Gr.8	Gr.9	Gr.10	Gr.11			
M	Metal	0	116	348	502	638	792	908	1006	1102	1218	1334	1450	1586			
U	Upholstered	0	116	348	502	638	792	908	1006	1102	1218	1334	1450	1586			
													Leather				
		Gr.12	Gr.13	Gr.14	Gr.15	Gr.16	Gr.17	Gr.18	Gr.19	Gr.20	Gr.8	Gr.9	Gr.10	Gr.11	LB	LC	LD
M	Metal	1740	1934	2126	2320	2514	2706	2900	3094	3286	2204	2398	2592	2786	2204	3248	3596
U	Upholstered	1740	1934	2126	2320	2514	2706	2900	3094	3286	2204	2398	2592	2786	2204	3248	3596
		Leg															
		COM	COL	Gr.1	Gr.2	Gr.3	Gr.4	Gr.5	Gr.6	Gr.7	Gr.8	Gr.9	Gr.10	Gr.11			
M	Metal	n/a	n/a	n/a	n/a	n/a	n/a	n/a	n/a	n/a	n/a	n/a	n/a	n/a			
U	Upholstered	0	116	174	252	319	397	455	502	551	609	667	725	792			
													Leather				
		Gr.12	Gr.13	Gr.14	Gr.15	Gr.16	Gr.17	Gr.18	Gr.19	Gr.20	Gr.8	Gr.9	Gr.10	Gr.11	LB	LC	LD
M	Metal	n/a	n/a	n/a	n/a	n/a	n/a	n/a	n/a	n/a	n/a	n/a	n/a	n/a	n/a	n/a	n/a
U	Upholstered	870	966	1064	1160	1256	1354	1546	1546	1644	1168	1264	1360	1456	1168	1694	1869

STP7G clique seven-seat bench, right no back

Product Options

Leg Style	Seat Upholstery	Leg Finish
U Upholstered	Fabric	Fabric
M Metal	Leather	Leather
		C9 Polished Aluminum
		Fundamental Paint
		Fashion Paint

Note For Polished Aluminum, add \$0
 For Fundamental Paint, add \$174
 For Fashion Paint, add \$290

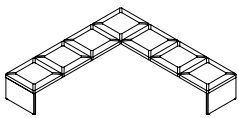

		Seat															
		COM	COL	Gr.1	Gr.2	Gr.3	Gr.4	Gr.5	Gr.6	Gr.7	Gr.8	Gr.9	Gr.10	Gr.11			
M	Metal	6294	6672	6700	6881	7039	7219	7354	7467	7579	7715	7851	7985	8143			
U	Upholstered	6680	7082	7086	7267	7425	7605	7741	7853	7966	8101	8237	8372	8529			
													Leather				
		Gr.12	Gr.13	Gr.14	Gr.15	Gr.16	Gr.17	Gr.18	Gr.19	Gr.20	Gr.9	Gr.10	Gr.11	Gr.12	Gr.13	Gr.14	
M	Metal	8324	8549	8775	9000	9227	9452	9678	9903	10129	9116	10338	10745	9116	10338	10745	
U	Upholstered	8710	8935	9162	9387	9613	9838	10064	10289	10515	9526	10747	11155	9526	10747	11155	
		Leg															
		COM	COL	Gr.1	Gr.2	Gr.3	Gr.4	Gr.5	Gr.6	Gr.7	Gr.8	Gr.9	Gr.10	Gr.11			
M	Metal	n/a	n/a	n/a	n/a	n/a	n/a	n/a	n/a	n/a	n/a	n/a	n/a	n/a			
U	Upholstered	0	116	174	252	319	397	455	502	551	609	667	725	792			
													Leather				
		Gr.12	Gr.13	Gr.14	Gr.15	Gr.16	Gr.17	Gr.18	Gr.19	Gr.20	Gr.9	Gr.10	Gr.11	Gr.12	Gr.13	Gr.14	
M	Metal	n/a	n/a	n/a	n/a	n/a	n/a	n/a	n/a	n/a	n/a	n/a	n/a	n/a	n/a	n/a	
U	Upholstered	870	966	1064	1160	1256	1354	1546	1546	1644	1168	1694	1869	1168	1694	1869	

STP7H clique seven-seat bench, right full back

Product Options

Leg Style	Seat Upholstery	Back Upholstery	Leg Finish
U Upholstered	Fabric	Fabric	Fabric
M Metal	Leather	Leather	Leather
			C9 Polished Aluminum
			Fundamental Paint
			Fashion Paint

Note For Polished Aluminum, add \$0
 For Fundamental Paint, add \$174
 For Fashion Paint, add \$290

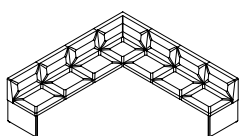

		Seat															
		COM	COL	Gr.1	Gr.2	Gr.3	Gr.4	Gr.5	Gr.6	Gr.7	Gr.8	Gr.9	Gr.10	Gr.11			
M	Metal	9509	10080	9915	10095	10253	10433	10569	10681	10794	10930	11065	11200	11358			
U	Upholstered	9895	10490	10301	10482	10640	10819	10955	11068	11180	11316	11452	11586	11744			
													Leather				
		Gr.12	Gr.13	Gr.14	Gr.15	Gr.16	Gr.17	Gr.18	Gr.19	Gr.20	LB	LC	LD				
M	Metal	11539	11764	11990	12215	12441	12666	12892	13117	13343	12525	13746	14153				
U	Upholstered	11925	12150	12376	12601	12827	13052	13279	13504	13730	12934	14155	14563				
		Back															
		COM	COL	Gr.1	Gr.2	Gr.3	Gr.4	Gr.5	Gr.6	Gr.7	Gr.8	Gr.9	Gr.10	Gr.11			
M	Metal	0	116	464	670	850	1057	1211	1341	1470	1624	1778	1934	2114			
U	Upholstered	0	116	464	670	850	1057	1211	1341	1470	1624	1778	1934	2114			
													Leather				
		Gr.12	Gr.13	Gr.14	Gr.15	Gr.16	Gr.17	Gr.18	Gr.19	Gr.20	LB	LC	LD				
M	Metal	2320	2578	2835	3094	3351	3609	3866	4125	4382	2900	4292	4756				
U	Upholstered	2320	2578	2835	3094	3351	3609	3866	4125	4382	2900	4292	4756				
		Leg															
		COM	COL	Gr.1	Gr.2	Gr.3	Gr.4	Gr.5	Gr.6	Gr.7	Gr.8	Gr.9	Gr.10	Gr.11			
M	Metal	n/a	n/a	n/a	n/a	n/a	n/a	n/a	n/a	n/a	n/a	n/a	n/a	n/a			
U	Upholstered	0	116	174	252	319	397	455	502	551	609	667	725	792			
													Leather				
		Gr.12	Gr.13	Gr.14	Gr.15	Gr.16	Gr.17	Gr.18	Gr.19	Gr.20	LB	LC	LD				
M	Metal	n/a	n/a	n/a	n/a	n/a	n/a	n/a	n/a	n/a	n/a	n/a	n/a				
U	Upholstered	870	966	1064	1160	1256	1354	1546	1546	1644	1168	1694	1869				

STP7J clique seven-seat bench, right full back with open run-off

Product Options

Leg Style	Seat Upholstery	Back Upholstery	Leg Finish
U Upholstered	Fabric	Fabric	Fabric
M Metal	Leather	Leather	Leather
			C9 Polished Aluminum
			Fundamental Paint
			Fashion Paint

Note For Polished Aluminum, add \$0
 For Fundamental Paint, add \$174
 For Fashion Paint, add \$290

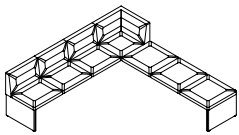

		Seat												
		COM	COL	Gr.1	Gr.2	Gr.3	Gr.4	Gr.5	Gr.6	Gr.7	Gr.8	Gr.9	Gr.10	Gr.11
M	Metal	8352	8854	8758	8939	9097	9277	9412	9525	9637	9773	9909	10043	10201
U	Upholstered	8738	9264	9144	9325	9483	9663	9799	9911	10024	10159	10295	10430	10587
												Leather		
		Gr.12	Gr.13	Gr.14	Gr.15	Gr.16	Gr.17	Gr.18	Gr.19	Gr.20	LB	LC	LD	
M	Metal	10382	10607	10833	11058	11284	11510	11736	11961	12187	11298	12520	12927	
U	Upholstered	10768	10993	11220	11445	11671	11896	12122	12347	12573	11708	12929	13337	
		Back												
		COM	COL	Gr.1	Gr.2	Gr.3	Gr.4	Gr.5	Gr.6	Gr.7	Gr.8	Gr.9	Gr.10	Gr.11
M	Metal	0	116	348	502	638	792	908	1006	1102	1218	1334	1450	1586
U	Upholstered	0	116	348	502	638	792	908	1006	1102	1218	1334	1450	1586
												Leather		
		Gr.12	Gr.13	Gr.14	Gr.15	Gr.16	Gr.17	Gr.18	Gr.19	Gr.20	LB	LC	LD	
M	Metal	1740	1934	2126	2320	2514	2706	2900	3094	3286	2204	3248	3596	
U	Upholstered	1740	1934	2126	2320	2514	2706	2900	3094	3286	2204	3248	3596	
		Leg												
		COM	COL	Gr.1	Gr.2	Gr.3	Gr.4	Gr.5	Gr.6	Gr.7	Gr.8	Gr.9	Gr.10	Gr.11
M	Metal	n/a	n/a	n/a	n/a	n/a	n/a	n/a	n/a	n/a	n/a	n/a	n/a	n/a
U	Upholstered	0	116	174	252	319	397	455	502	551	609	667	725	792
												Leather		
		Gr.12	Gr.13	Gr.14	Gr.15	Gr.16	Gr.17	Gr.18	Gr.19	Gr.20	LB	LC	LD	
M	Metal	n/a	n/a	n/a	n/a	n/a	n/a	n/a	n/a	n/a	n/a	n/a	n/a	
U	Upholstered	870	966	1064	1160	1256	1354	1546	1546	1644	1168	1694	1869	

STP7K clique seven-seat bench, right full back with open ends

Product Options

Leg Style	Seat Upholstery	Back Upholstery	Leg Finish
U Upholstered	Fabric	Fabric	Fabric
M Metal	Leather	Leather	Leather
			C9 Polished Aluminum
			Fundamental Paint
			Fashion Paint

Note For Polished Aluminum, add \$0
 For Fundamental Paint, add \$174
 For Fashion Paint, add \$290

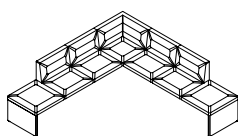

		Seat																				
		COM	COL	Gr.1	Gr.2	Gr.3	Gr.4	Gr.5	Gr.6	Gr.7	Gr.8	Gr.9	Gr.10	Gr. 11								
M	Metal	8481	8991	8887	9068	9225	9405	9541	9654	9766	9902	10037	10172	10330								
U	Upholstered	8867	9401	9273	9454	9612	9792	9927	10040	10152	10288	10424	10558	10716								
													Leather									
		Gr.12	Gr.13	Gr.14	Gr.15	Gr.16	Gr.17	Gr.18	Gr.19	Gr.20	Gr.12	Gr.13	Gr.14	Gr.15	Gr.16	Gr.17	Gr.18	Gr.19	Gr.20	LB	LC	LD
M	Metal	10511	10736	10962	11187	11413	11638	11864	12090	12316	11435	11660	11885	12110	12335	12560	12785	13010	13235	11435	12657	13064
U	Upholstered	10897	11122	11348	11573	11800	12025	12251	12476	12702	11845	12070	12295	12520	12745	12970	13195	13420	11845	13066	13473	
		Back																				
		COM	COL	Gr.1	Gr.2	Gr.3	Gr.4	Gr.5	Gr.6	Gr.7	Gr.8	Gr.9	Gr.10	Gr. 11								
M	Metal	0	116	348	502	638	792	908	1006	1102	1218	1334	1450	1586								
U	Upholstered	0	116	348	502	638	792	908	1006	1102	1218	1334	1450	1586								
													Leather									
		Gr.12	Gr.13	Gr.14	Gr.15	Gr.16	Gr.17	Gr.18	Gr.19	Gr.20	Gr.12	Gr.13	Gr.14	Gr.15	Gr.16	Gr.17	Gr.18	Gr.19	Gr.20	LB	LC	LD
M	Metal	1740	1934	2126	2320	2514	2706	2900	3094	3286	2204	2398	2592	2786	2980	3174	3368	3562	3756	2204	3248	3596
U	Upholstered	1740	1934	2126	2320	2514	2706	2900	3094	3286	2204	2398	2592	2786	2980	3174	3368	3562	3756	2204	3248	3596
		Leg																				
		COM	COL	Gr.1	Gr.2	Gr.3	Gr.4	Gr.5	Gr.6	Gr.7	Gr.8	Gr.9	Gr.10	Gr. 11								
M	Metal	n/a	n/a	n/a	n/a	n/a	n/a	n/a	n/a	n/a	n/a	n/a	n/a	n/a								
U	Upholstered	0	116	174	252	319	397	455	502	551	609	667	725	792								
													Leather									
		Gr.12	Gr.13	Gr.14	Gr.15	Gr.16	Gr.17	Gr.18	Gr.19	Gr.20	Gr.12	Gr.13	Gr.14	Gr.15	Gr.16	Gr.17	Gr.18	Gr.19	Gr.20	LB	LC	LD
M	Metal	n/a	n/a	n/a	n/a	n/a	n/a	n/a	n/a	n/a	n/a	n/a	n/a	n/a	n/a	n/a	n/a	n/a	n/a	n/a	n/a	n/a
U	Upholstered	870	966	1064	1160	1256	1354	1546	1546	1644	1168	1264	1360	1456	1552	1648	1744	1840	1168	1694	1869	

STP8C clique eight-seat bench, left no back

Product Options

Leg Style	Seat Upholstery	Leg Finish
U Upholstered	Fabric	Fabric
M Metal	Leather	Leather
		C9 Polished Aluminum
		Fundamental Paint
		Fashion Paint

Note For Polished Aluminum, add \$0
 For Fundamental Paint, add \$174
 For Fashion Paint, add \$290

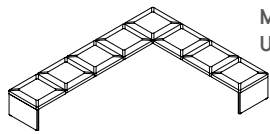

M Metal
 U Upholstered

Seat

COM	COL	Gr.1	Gr.2	Gr.3	Gr.4	Gr.5	Gr.6	Gr.7	Gr.8	Gr.9	Gr.10	Gr.11
7067	7491	7531	7737	7917	8123	8278	8408	8536	8691	8845	9000	9180
7452	7900	7916	8122	8302	8509	8663	8793	8922	9076	9230	9386	9565

Leather

M Metal
 U Upholstered

Gr.12	Gr.13	Gr.14	Gr.15	Gr.16	Gr.17	Gr.18	Gr.19	Gr.20	LB	LC	LD
9387	9644	9902	10160	10418	10675	10933	11192	11449	10275	11667	12131
9772	10029	10287	10546	10803	11061	11318	11577	11834	10684	12076	12540

Leg

M Metal
 U Upholstered

COM	COL	Gr.1	Gr.2	Gr.3	Gr.4	Gr.5	Gr.6	Gr.7	Gr.8	Gr.9	Gr.10	Gr.11
n/a	n/a	n/a	n/a	n/a	n/a	n/a	n/a	n/a	n/a	n/a	n/a	n/a
0	116	174	252	319	397	455	502	551	609	667	725	792

M Metal
 U Upholstered

Gr.12	Gr.13	Gr.14	Gr.15	Gr.16	Gr.17	Gr.18	Gr.19	Gr.20	LB	LC	LD
n/a	n/a	n/a	n/a	n/a	n/a	n/a	n/a	n/a	n/a	n/a	n/a
870	966	1064	1160	1256	1354	1546	1546	1644	1168	1694	1869

STP8D clique eight-seat bench, left full back

Product Options

Leg Style	Seat Upholstery	Back Upholstery	Leg Finish
U Upholstered	Fabric	Fabric	Fabric
M Metal	Leather	Leather	Leather
			C9 Polished Aluminum
			Fundamental Paint
			Fashion Paint

Note For Polished Aluminum, add \$0
 For Fundamental Paint, add \$174
 For Fashion Paint, add \$290

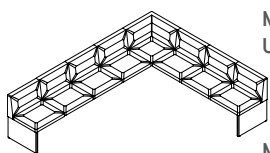

		Seat												
		COM	COL	Gr.1	Gr.2	Gr.3	Gr.4	Gr.5	Gr.6	Gr.7	Gr.8	Gr.9	Gr.10	Gr.11
M Metal		10281	10899	10745	10952	11131	11338	11492	11622	11751	11905	12059	12215	12395
U Upholstered		10667	11309	11131	11338	11518	11724	11878	12008	12137	12291	12446	12601	12781
												Leather		
		Gr.12	Gr.13	Gr.14	Gr.15	Gr.16	Gr.17	Gr.18	Gr.19	Gr.20	LB	LC	LD	
M Metal		12601	12859	13116	13375	13632	13890	14147	14406	14664	13683	15075	15539	
U Upholstered		12987	13245	13502	13761	14019	14276	14534	14792	15050	14093	15485	15949	
		Back												
		COM	COL	Gr.1	Gr.2	Gr.3	Gr.4	Gr.5	Gr.6	Gr.7	Gr.8	Gr.9	Gr.10	Gr.11
M Metal		0	116	522	754	957	1189	1363	1508	1653	1827	2001	2175	2378
U Upholstered		0	116	522	754	957	1189	1363	1508	1653	1827	2001	2175	2378
												Leather		
		Gr.12	Gr.13	Gr.14	Gr.15	Gr.16	Gr.17	Gr.18	Gr.19	Gr.20	LB	LC	LD	
M Metal		2610	2900	3190	3480	3770	4060	4350	4640	4930	3256	4826	5349	
U Upholstered		2610	2900	3190	3480	3770	4060	4350	4640	4930	3256	4826	5349	
		Leg												
		COM	COL	Gr.1	Gr.2	Gr.3	Gr.4	Gr.5	Gr.6	Gr.7	Gr.8	Gr.9	Gr.10	Gr.11
M Metal		n/a	n/a	n/a	n/a	n/a	n/a	n/a	n/a	n/a	n/a	n/a	n/a	n/a
U Upholstered		0	116	174	252	319	397	455	502	551	609	667	725	792
												Leather		
		Gr.12	Gr.13	Gr.14	Gr.15	Gr.16	Gr.17	Gr.18	Gr.19	Gr.20	LB	LC	LD	
M Metal		n/a	n/a	n/a	n/a	n/a	n/a	n/a	n/a	n/a	n/a	n/a	n/a	
U Upholstered		870	966	1064	1160	1256	1354	1546	1546	1644	1168	1694	1869	

STP8E clique eight-seat bench, left full back with open run-off

Product Options

Leg Style	Seat Upholstery	Back Upholstery	Leg Finish
U Upholstered	Fabric	Fabric	Fabric
M Metal	Leather	Leather	Leather
			C9 Polished Aluminum
			Fundamental Paint
			Fashion Paint

Note For Polished Aluminum, add \$0
 For Fundamental Paint, add \$174
 For Fashion Paint, add \$290

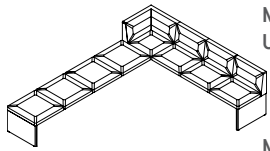

M Metal
 U Upholstered

Seat

COM	COL	Gr.1	Gr.2	Gr.3	Gr.4	Gr.5	Gr.6	Gr.7	Gr.8	Gr.9	Gr.10	Gr.11
9125	9673	9589	9795	9975	10181	10336	10466	10594	10749	10903	11058	11238
9509	10080	9973	10179	10359	10565	10720	10849	10978	11133	11287	11442	11622

Leather

M Metal
 U Upholstered

Gr.12	Gr.13	Gr.14	Gr.15	Gr.16	Gr.17	Gr.18	Gr.19	Gr.20	LB	LC	LD
11445	11702	11960	12218	12476	12733	12991	13250	13507	12457	13849	14313
11829	12086	12344	12602	12860	13117	13375	13633	13891	12864	14256	14720

Back

M Metal
 U Upholstered

COM	COL	Gr.1	Gr.2	Gr.3	Gr.4	Gr.5	Gr.6	Gr.7	Gr.8	Gr.9	Gr.10	Gr.11
0	116	406	587	745	925	1060	1173	1285	1421	1557	1691	1849
0	116	406	587	745	925	1060	1173	1285	1421	1557	1691	1849

Leather

M Metal
 U Upholstered

Gr.12	Gr.13	Gr.14	Gr.15	Gr.16	Gr.17	Gr.18	Gr.19	Gr.20	LB	LC	LD
2030	2255	2481	2706	2932	3158	3384	3609	3835	2560	3782	4189
2030	2255	2481	2706	2932	3158	3384	3609	3835	2560	3782	4189

Leg

M Metal
 U Upholstered

COM	COL	Gr.1	Gr.2	Gr.3	Gr.4	Gr.5	Gr.6	Gr.7	Gr.8	Gr.9	Gr.10	Gr.11
n/a	n/a	n/a	n/a	n/a	n/a	n/a	n/a	n/a	n/a	n/a	n/a	n/a
0	116	174	252	319	397	455	502	551	609	667	725	792

Leather

M Metal
 U Upholstered

Gr.12	Gr.13	Gr.14	Gr.15	Gr.16	Gr.17	Gr.18	Gr.19	Gr.20	LB	LC	LD
n/a	n/a	n/a	n/a	n/a	n/a	n/a	n/a	n/a	n/a	n/a	n/a
870	966	1064	1160	1256	1354	1546	1546	1644	1168	1694	1869

STP8F clique eight-seat bench, left full back with open ends

Product Options

Leg Style	Seat Upholstery	Back Upholstery	Leg Finish
U Upholstered	Fabric	Fabric	Fabric
M Metal	Leather	Leather	Leather
			C9 Polished Aluminum
			Fundamental Paint
			Fashion Paint

Note For Polished Aluminum, add \$0
 For Fundamental Paint, add \$174
 For Fashion Paint, add \$290

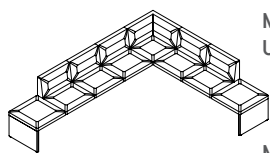

		Seat												
		COM	COL	Gr.1	Gr.2	Gr.3	Gr.4	Gr.5	Gr.6	Gr.7	Gr.8	Gr.9	Gr.10	Gr. 11
M Metal		9252	9809	9716	9923	10102	10309	10463	10593	10722	10876	11030	11186	11366
U Upholstered		9638	10218	10102	10309	10489	10695	10849	10979	11108	11262	11417	11572	11752
												Leather		
												LB	LC	LD
M Metal		11572	11830	12087	12346	12603	12861	13118	13377	13635		12593	13985	14449
U Upholstered		11958	12216	12473	12732	12990	13247	13505	13763	14021		13002	14394	14858
		Back												
		COM	COL	Gr.1	Gr.2	Gr.3	Gr.4	Gr.5	Gr.6	Gr.7	Gr.8	Gr.9	Gr.10	Gr. 11
M Metal		0	116	406	587	745	925	1060	1173	1285	1421	1557	1691	1849
U Upholstered		0	116	406	587	745	925	1060	1173	1285	1421	1557	1691	1849
												Leather		
												LB	LC	LD
M Metal		2030	2255	2481	2706	2932	3158	3384	3609	3835		2560	3782	4189
U Upholstered		2030	2255	2481	2706	2932	3158	3384	3609	3835		2560	3782	4189
		Leg												
		COM	COL	Gr.1	Gr.2	Gr.3	Gr.4	Gr.5	Gr.6	Gr.7	Gr.8	Gr.9	Gr.10	Gr. 11
M Metal		n/a	n/a	n/a	n/a	n/a	n/a	n/a	n/a	n/a	n/a	n/a	n/a	n/a
U Upholstered		0	116	174	252	319	397	455	502	551	609	667	725	792
												Leather		
												LB	LC	LD
M Metal		n/a	n/a	n/a	n/a	n/a	n/a	n/a	n/a	n/a		n/a	n/a	n/a
U Upholstered		870	966	1064	1160	1256	1354	1546	1546	1644		1168	1694	1869

STP8G clique eight-seat bench, right no back

Product Options

Leg Style	Seat Upholstery	Leg Finish
U Upholstered	Fabric	Fabric
M Metal	Leather	Leather
		C9 Polished Aluminum
		Fundamental Paint
		Fashion Paint

Note For Polished Aluminum, add \$0
 For Fundamental Paint, add \$174
 For Fashion Paint, add \$290

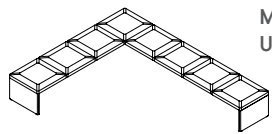

M Metal
 U Upholstered

Seat

COM	COL	Gr.1	Gr.2	Gr.3	Gr.4	Gr.5	Gr.6	Gr.7	Gr.8	Gr.9	Gr.10	Gr.11
7067	7491	7531	7737	7917	8123	8278	8408	8536	8691	8845	9000	9180
7452	7900	7916	8122	8302	8509	8663	8793	8922	9076	9230	9386	9565

Leather

M Metal
 U Upholstered

Gr.12	Gr.13	Gr.14	Gr.15	Gr.16	Gr.17	Gr.18	Gr.19	Gr.20	LB	LC	LD
9387	9644	9902	10160	10418	10675	10933	11192	11449	10275	11667	12131
9772	10029	10287	10546	10803	11061	11318	11577	11834	10684	12076	12540

Leg

M Metal
 U Upholstered

COM	COL	Gr.1	Gr.2	Gr.3	Gr.4	Gr.5	Gr.6	Gr.7	Gr.8	Gr.9	Gr.10	Gr.11
n/a	n/a	n/a	n/a	n/a	n/a	n/a	n/a	n/a	n/a	n/a	n/a	n/a
0	116	174	252	319	397	455	502	551	609	667	725	792

M Metal
 U Upholstered

Gr.12	Gr.13	Gr.14	Gr.15	Gr.16	Gr.17	Gr.18	Gr.19	Gr.20	LB	LC	LD
n/a	n/a	n/a	n/a	n/a	n/a	n/a	n/a	n/a	n/a	n/a	n/a
870	966	1064	1160	1256	1354	1546	1546	1644	1168	1694	1869

STP8H clique eight-seat bench, right full back

Product Options

Leg Style	Seat Upholstery	Back Upholstery	Leg Finish
U Upholstered	Fabric	Fabric	Fabric
M Metal	Leather	Leather	Leather
			C9 Polished Aluminum
			Fundamental Paint
			Fashion Paint

Note For Polished Aluminum, add \$0
 For Fundamental Paint, add \$174
 For Fashion Paint, add \$290

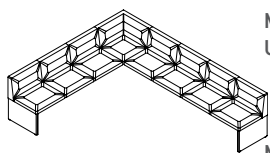

		Seat												
		COM	COL	Gr.1	Gr.2	Gr.3	Gr.4	Gr.5	Gr.6	Gr.7	Gr.8	Gr.9	Gr.10	Gr.11
M Metal		10281	10899	10745	10952	11131	11338	11492	11622	11751	11905	12059	12215	12395
U Upholstered		10667	11309	11131	11338	11518	11724	11878	12008	12137	12291	12446	12601	12781
												Leather		
		Gr.12	Gr.13	Gr.14	Gr.15	Gr.16	Gr.17	Gr.18	Gr.19	Gr.20	LB	LC	LD	
M Metal		12601	12859	13116	13375	13632	13890	14147	14406	14664	13683	15075	15539	
U Upholstered		12987	13245	13502	13761	14019	14276	14534	14792	15050	14093	15485	15949	
		Back												
		COM	COL	Gr.1	Gr.2	Gr.3	Gr.4	Gr.5	Gr.6	Gr.7	Gr.8	Gr.9	Gr.10	Gr.11
M Metal		0	116	522	754	957	1189	1363	1508	1653	1827	2001	2175	2378
U Upholstered		0	116	522	754	957	1189	1363	1508	1653	1827	2001	2175	2378
												Leather		
		Gr.12	Gr.13	Gr.14	Gr.15	Gr.16	Gr.17	Gr.18	Gr.19	Gr.20	LB	LC	LD	
M Metal		2610	2900	3190	3480	3770	4060	4350	4640	4930	3256	4826	5349	
U Upholstered		2610	2900	3190	3480	3770	4060	4350	4640	4930	3256	4826	5349	
		Leg												
		COM	COL	Gr.1	Gr.2	Gr.3	Gr.4	Gr.5	Gr.6	Gr.7	Gr.8	Gr.9	Gr.10	Gr.11
M Metal		n/a	n/a	n/a	n/a	n/a	n/a	n/a	n/a	n/a	n/a	n/a	n/a	n/a
U Upholstered		0	116	174	252	319	397	455	502	551	609	667	725	792
												Leather		
		Gr.12	Gr.13	Gr.14	Gr.15	Gr.16	Gr.17	Gr.18	Gr.19	Gr.20	LB	LC	LD	
M Metal		n/a	n/a	n/a	n/a	n/a	n/a	n/a	n/a	n/a	n/a	n/a	n/a	
U Upholstered		870	966	1064	1160	1256	1354	1546	1546	1644	1168	1694	1869	

STP8J clique eight-seat bench, right full back with open run-off

Product Options

Leg Style	Seat Upholstery	Back Upholstery	Leg Finish
U Upholstered	Fabric	Fabric	Fabric
M Metal	Leather	Leather	Leather
			C9 Polished Aluminum
			Fundamental Paint
			Fashion Paint

Note For Polished Aluminum, add \$0
 For Fundamental Paint, add \$174
 For Fashion Paint, add \$290

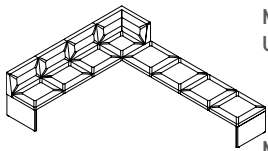

		Seat												
		COM	COL	Gr.1	Gr.2	Gr.3	Gr.4	Gr.5	Gr.6	Gr.7	Gr.8	Gr.9	Gr.10	Gr.11
M Metal		9125	9673	9589	9795	9975	10181	10336	10466	10594	10749	10903	11058	11238
U Upholstered		9509	10080	9973	10179	10359	10565	10720	10849	10978	11133	11287	11442	11622
												Leather		
		Gr.12	Gr.13	Gr.14	Gr.15	Gr.16	Gr.17	Gr.18	Gr.19	Gr.20	LB	LC	LD	
M Metal		11445	11702	11960	12218	12476	12733	12991	13250	13507	12457	13849	14313	
U Upholstered		11829	12086	12344	12602	12860	13117	13375	13633	13891	12864	14256	14720	
		Back												
		COM	COL	Gr.1	Gr.2	Gr.3	Gr.4	Gr.5	Gr.6	Gr.7	Gr.8	Gr.9	Gr.10	Gr.11
M Metal		0	116	406	587	745	925	1060	1173	1285	1421	1557	1691	1849
U Upholstered		0	116	406	587	745	925	1060	1173	1285	1421	1557	1691	1849
												Leather		
		Gr.12	Gr.13	Gr.14	Gr.15	Gr.16	Gr.17	Gr.18	Gr.19	Gr.20	LB	LC	LD	
M Metal		2030	2255	2481	2706	2932	3158	3384	3609	3835	2560	3782	4189	
U Upholstered		2030	2255	2481	2706	2932	3158	3384	3609	3835	2560	3782	4189	
		Leg												
		COM	COL	Gr.1	Gr.2	Gr.3	Gr.4	Gr.5	Gr.6	Gr.7	Gr.8	Gr.9	Gr.10	Gr.11
M Metal		n/a	n/a	n/a	n/a	n/a	n/a	n/a	n/a	n/a	n/a	n/a	n/a	n/a
U Upholstered		0	116	174	252	319	397	455	502	551	609	667	725	792
												Leather		
		Gr.12	Gr.13	Gr.14	Gr.15	Gr.16	Gr.17	Gr.18	Gr.19	Gr.20	LB	LC	LD	
M Metal		n/a	n/a	n/a	n/a	n/a	n/a	n/a	n/a	n/a	n/a	n/a	n/a	
U Upholstered		870	966	1064	1160	1256	1354	1546	1546	1644	1168	1694	1869	

STP8K clique eight-seat bench, right full back with open ends

Product Options

Leg Style	Seat Upholstery	Back Upholstery	Leg Finish
U Upholstered	Fabric	Fabric	Fabric
M Metal	Leather	Leather	Leather
			C9 Polished Aluminum
			Fundamental Paint
			Fashion Paint

Note For Polished Aluminum, add \$0
 For Fundamental Paint, add \$174
 For Fashion Paint, add \$290

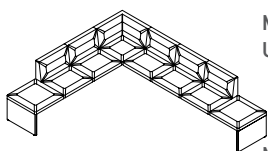

		Seat											Leather				
		COM	COL	Gr.1	Gr.2	Gr.3	Gr.4	Gr.5	Gr.6	Gr.7	Gr.8	Gr.9	Gr.10	Gr.11	LB	LC	LD
M	Metal	9252	9809	9716	9923	10102	10309	10463	10593	10722	10876	11030	11186	11366			
U	Upholstered	9638	10218	10102	10309	10489	10695	10849	10979	11108	11262	11417	11572	11752			
		Gr.12	Gr.13	Gr.14	Gr.15	Gr.16	Gr.17	Gr.18	Gr.19	Gr.20							
M	Metal	11572	11830	12087	12346	12603	12861	13118	13377	13635					12593	13985	14449
U	Upholstered	11958	12216	12473	12732	12990	13247	13505	13763	14021					13002	14394	14858
		Back											Leather				
		COM	COL	Gr.1	Gr.2	Gr.3	Gr.4	Gr.5	Gr.6	Gr.7	Gr.8	Gr.9	Gr.10	Gr.11	LB	LC	LD
M	Metal	0	116	406	587	745	925	1060	1173	1285	1421	1557	1691	1849			
U	Upholstered	0	116	406	587	745	925	1060	1173	1285	1421	1557	1691	1849			
		Gr.12	Gr.13	Gr.14	Gr.15	Gr.16	Gr.17	Gr.18	Gr.19	Gr.20							
M	Metal	2030	2255	2481	2706	2932	3158	3384	3609	3835					2560	3782	4189
U	Upholstered	2030	2255	2481	2706	2932	3158	3384	3609	3835					2560	3782	4189
		Leg											Leather				
		COM	COL	Gr.1	Gr.2	Gr.3	Gr.4	Gr.5	Gr.6	Gr.7	Gr.8	Gr.9	Gr.10	Gr.11	LB	LC	LD
M	Metal	n/a	n/a	n/a	n/a	n/a	n/a	n/a	n/a	n/a	n/a	n/a	n/a	n/a			
U	Upholstered	0	116	174	252	319	397	455	502	551	609	667	725	792			
		Gr.12	Gr.13	Gr.14	Gr.15	Gr.16	Gr.17	Gr.18	Gr.19	Gr.20							
M	Metal	n/a	n/a	n/a	n/a	n/a	n/a	n/a	n/a	n/a					n/a	n/a	n/a
U	Upholstered	870	966	1064	1160	1256	1354	1546	1546	1644					1168	1694	1869

STPT5C clique five-seat bench with table, no back, left run-off

Product Options

Leg Style	Table Style	Seat Upholstery	Leg Finish	Table Finish
U Upholstered	C Corner Table	Fabric	Fabric	Studio Foundation
M Metal	E End Tables	Leather	Leather	Laminate
			C9 Polished Aluminum	Studio Veneer
			Fundamental Paint	
			Fashion Paint	

Note For Polished Aluminum, add \$0
 For Fundamental Paint, add \$174
 For Fashion Paint, add \$290

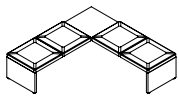

	Seat												
	COM	COL	Gr.1	Gr.2	Gr.3	Gr.4	Gr.5	Gr.6	Gr.7	Gr.8	Gr.9	Gr.10	Gr.11
M Metal, Corner Table	4754	5039	4986	5089	5179	5283	5359	5424	5488	5566	5643	5720	5810
M Metal, End Tables	4754	5039	4928	5005	5073	5150	5208	5256	5305	5363	5421	5479	5546
U Upholstered, Corner Table	5140	5449	5372	5475	5566	5669	5745	5810	5874	5952	6030	6106	6197
U Upholstered, End Tables	5140	5449	5314	5392	5459	5537	5595	5642	5691	5749	5807	5865	5932

											Leather		
	Gr.12	Gr.13	Gr.14	Gr.15	Gr.16	Gr.17	Gr.18	Gr.19	Gr.20	LB	LC	LD	
M Metal, Corner Table	5914	6042	6171	6300	6429	6559	6687	6816	6945	6431	7127	7359	
M Metal, End Tables	5624	5720	5817	5914	6010	6107	6204	6300	6397	6091	6617	6792	
U Upholstered, Corner Table	6300	6429	6557	6686	6815	6945	7074	7202	7331	6841	7537	7769	
U Upholstered, End Tables	6010	6106	6204	6300	6396	6494	6590	6686	6784	6501	7026	7201	

	Leg												
	COM	COL	Gr.1	Gr.2	Gr.3	Gr.4	Gr.5	Gr.6	Gr.7	Gr.8	Gr.9	Gr.10	Gr.11
M Metal, Corner Table	n/a	n/a	n/a	n/a	n/a	n/a	n/a	n/a	n/a	n/a	n/a	n/a	n/a
M Metal, End Tables	n/a	n/a	n/a	n/a	n/a	n/a	n/a	n/a	n/a	n/a	n/a	n/a	n/a
U Upholstered, Corner Table	0	116	174	252	319	397	455	502	551	609	667	725	792
U Upholstered, End Tables	0	116	174	252	319	397	455	502	551	609	667	725	792

											Leather		
	Gr.12	Gr.13	Gr.14	Gr.15	Gr.16	Gr.17	Gr.18	Gr.19	Gr.20	LB	LC	LD	
M Metal, Corner Table	n/a	n/a	n/a	n/a	n/a	n/a	n/a	n/a	n/a	n/a	n/a	n/a	
M Metal, End Tables	n/a	n/a	n/a	n/a	n/a	n/a	n/a	n/a	n/a	n/a	n/a	n/a	
U Upholstered, Corner Table	870	966	1064	1160	1256	1354	1546	1546	1644	1168	1694	1869	
U Upholstered, End Tables	870	966	1064	1160	1256	1354	1546	1546	1644	1168	1694	1869	

Table

	Studio	
	Foundation Laminate	Studio Veneer
M Metal, Corner Table	93	290
M Metal, End Tables	186	580
U Upholstered, Corner Table	93	290
U Upholstered, End Tables	186	580

STPT5D clique five-seat bench with table, full back, left run-off

Product Options

Leg Style	Table Style	Seat Upholstery	Back Upholstery	Leg Finish	Table Finish
U Upholstered	C Corner Table	Fabric	Fabric	Fabric	Studio Foundation
M Metal		Leather	Leather	Leather C9 Polished Aluminum Fundamental Paint Fashion Paint	Laminate Studio Veneer

Note For Polished Aluminum, add \$0
 For Fundamental Paint, add \$174
 For Fashion Paint, add \$290

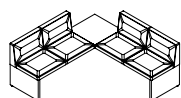

		Seat															
		COM	COL	Gr.1	Gr.2	Gr.3	Gr.4	Gr.5	Gr.6	Gr.7	Gr.8	Gr.9	Gr.10	Gr. 11			
M	Metal, Corner Table	7967	8446	8199	8302	8393	8496	8572	8637	8701	8779	8857	8933	9024			
U	Upholstered, Corner Table	8352	8854	8584	8687	8778	8881	8958	9022	9086	9164	9242	9318	9409			
													Leather				
		Gr.12	Gr.13	Gr.14	Gr.15	Gr.16	Gr.17	Gr.18	Gr.19	Gr.20	LB	LC	LD				
M	Metal, Corner Table	9127	9256	9384	9513	9642	9772	9901	10029	10158	9838	10534	10766				
U	Upholstered, Corner Table	9512	9641	9770	9898	10027	10157	10286	10414	10543	10246	10942	11174				
		Back															
		COM	COL	Gr.1	Gr.2	Gr.3	Gr.4	Gr.5	Gr.6	Gr.7	Gr.8	Gr.9	Gr.10	Gr. 11			
M	Metal, Corner Table	0	116	232	335	426	529	606	670	734	812	890	966	1057			
U	Upholstered, Corner Table	0	116	232	335	426	529	606	670	734	812	890	966	1057			
													Leather				
		Gr.12	Gr.13	Gr.14	Gr.15	Gr.16	Gr.17	Gr.18	Gr.19	Gr.20	LB	LC	LD				
M	Metal, Corner Table	1160	1289	1418	1546	1675	1805	1934	2062	2191	1508	2204	2436				
U	Upholstered, Corner Table	1160	1289	1418	1546	1675	1805	1934	2062	2191	1508	2204	2436				
		Leg															
		COM	COL	Gr.1	Gr.2	Gr.3	Gr.4	Gr.5	Gr.6	Gr.7	Gr.8	Gr.9	Gr.10	Gr. 11			
M	Metal, Corner Table	n/a	n/a	n/a	n/a	n/a	n/a	n/a	n/a	n/a	n/a	n/a	n/a	n/a			
U	Upholstered, Corner Table	0	116	174	252	319	397	455	502	551	609	667	725	792			
													Leather				
		Gr.12	Gr.13	Gr.14	Gr.15	Gr.16	Gr.17	Gr.18	Gr.19	Gr.20	LB	LC	LD				
M	Metal, Corner Table	n/a	n/a	n/a	n/a	n/a	n/a	n/a	n/a	n/a	n/a	n/a	n/a				
U	Upholstered, Corner Table	870	966	1064	1160	1256	1354	1546	1546	1644	1168	1694	1869				
		Table															
		Studio															
		Foundation	Laminate	Studio													
				Veneer													
M	Metal, Corner Table	0	0	58													
U	Upholstered, Corner Table	0	0	58													

STPT5F clique five-seat bench with table, back with open ends, left run-off

Product Options

Leg Style	Table Style	Seat Upholstery	Back Upholstery	Leg Finish	Table Finish
U Upholstered	E End Tables	Fabric	Fabric	Fabric	Studio Foundation
M Metal		Leather	Leather	Leather C9 Polished Aluminum Fundamental Paint Fashion Paint	Laminate Studio Veneer

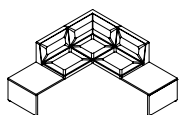

		Seat												
		COM	COL	Gr.1	Gr.2	Gr.3	Gr.4	Gr.5	Gr.6	Gr.7	Gr.8	Gr.9	Gr.10	Gr.11
M	Metal, End Tables	7137	7567	7311	7389	7456	7534	7592	7640	7688	7746	7804	7862	7930
U	Upholstered, End Tables	7424	7871	7598	7676	7743	7821	7879	7926	7975	8033	8091	8149	8216
												Leather		
		Gr.12	Gr.13	Gr.14	Gr.15	Gr.16	Gr.17	Gr.18	Gr.19	Gr.20	LB	LC	LD	
M	Metal, End Tables	8007	8104	8201	8297	8394	8491	8587	8684	8781	8619	9144	9319	
U	Upholstered, End Tables	8294	8390	8488	8584	8680	8778	8874	8970	9068	8923	9448	9623	
		Back												
		COM	COL	Gr.1	Gr.2	Gr.3	Gr.4	Gr.5	Gr.6	Gr.7	Gr.8	Gr.9	Gr.10	Gr.11
M	Metal, End Tables	0	116	232	335	426	529	606	670	734	812	890	966	1057
U	Upholstered, End Tables	0	116	232	335	426	529	606	670	734	812	890	966	1057
												Leather		
		Gr.12	Gr.13	Gr.14	Gr.15	Gr.16	Gr.17	Gr.18	Gr.19	Gr.20	LB	LC	LD	
M	Metal, End Tables	1160	1289	1418	1546	1675	1805	1934	2062	2191	1508	2204	2436	
U	Upholstered, End Tables	1160	1289	1418	1546	1675	1805	1934	2062	2191	1508	2204	2436	
		Leg												
		COM	COL	Gr.1	Gr.2	Gr.3	Gr.4	Gr.5	Gr.6	Gr.7	Gr.8	Gr.9	Gr.10	Gr.11
M	Metal, End Tables	n/a	n/a	n/a	n/a	n/a	n/a	n/a	n/a	n/a	n/a	n/a	n/a	n/a
U	Upholstered, End Tables	0	116	174	252	319	397	455	502	551	609	667	725	792
												Leather		
		Gr.12	Gr.13	Gr.14	Gr.15	Gr.16	Gr.17	Gr.18	Gr.19	Gr.20	LB	LC	LD	
M	Metal, End Tables	n/a	n/a	n/a	n/a	n/a	n/a	n/a	n/a	n/a	n/a	n/a	n/a	
U	Upholstered, End Tables	870	966	1064	1160	1256	1354	1546	1546	1644	1168	1694	1869	
		Table												
		Studio												
		Foundation	Studio											
		Laminate	Veneer											
M	Metal, End Tables	186	580											
U	Upholstered, End Tables	186	580											

STPT5G clique five-seat bench with table, no back, right run-off

Product Options

Leg Style	Table Style	Seat Upholstery	Leg Finish	Table Finish
U Upholstered	C Corner Table	Fabric	Fabric	Studio Foundation
M Metal	E End Tables	Leather	Leather	Laminate
			C9 Polished Aluminum	Studio Veneer
			Fundamental Paint	
			Fashion Paint	

Note For Polished Aluminum, add \$0
 For Fundamental Paint, add \$174
 For Fashion Paint, add \$290

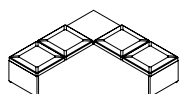

	Seat												
	COM	COL	Gr.1	Gr.2	Gr.3	Gr.4	Gr.5	Gr.6	Gr.7	Gr.8	Gr.9	Gr.10	Gr.11
M Metal, Corner Table	4754	5039	4986	5089	5179	5283	5359	5424	5488	5566	5643	5720	5810
M Metal, End Tables	4754	5039	4928	5005	5073	5150	5208	5256	5305	5363	5421	5479	5546
U Upholstered, Corner Table	5140	5449	5372	5475	5566	5669	5745	5810	5874	5952	6030	6106	6197
U Upholstered, End Tables	5140	5449	5314	5392	5459	5537	5595	5642	5691	5749	5807	5865	5932

											Leather		
	Gr.12	Gr.13	Gr.14	Gr.15	Gr.16	Gr.17	Gr.18	Gr.19	Gr.20	LB	LC	LD	
M Metal, Corner Table	5914	6042	6171	6300	6429	6559	6687	6816	6945	6431	7127	7359	
M Metal, End Tables	5624	5720	5817	5914	6010	6107	6204	6300	6397	6091	6617	6792	
U Upholstered, Corner Table	6300	6429	6557	6686	6815	6945	7074	7202	7331	6841	7537	7769	
U Upholstered, End Tables	6010	6106	6204	6300	6396	6494	6590	6686	6784	6501	7026	7201	

	Leg												
	COM	COL	Gr.1	Gr.2	Gr.3	Gr.4	Gr.5	Gr.6	Gr.7	Gr.8	Gr.9	Gr.10	Gr.11
M Metal, Corner Table	n/a	n/a	n/a	n/a	n/a	n/a	n/a	n/a	n/a	n/a	n/a	n/a	n/a
M Metal, End Tables	n/a	n/a	n/a	n/a	n/a	n/a	n/a	n/a	n/a	n/a	n/a	n/a	n/a
U Upholstered, Corner Table	0	116	174	252	319	397	455	502	551	609	667	725	792
U Upholstered, End Tables	0	116	174	252	319	397	455	502	551	609	667	725	792

											Leather		
	Gr.12	Gr.13	Gr.14	Gr.15	Gr.16	Gr.17	Gr.18	Gr.19	Gr.20	LB	LC	LD	
M Metal, Corner Table	n/a	n/a	n/a	n/a	n/a	n/a	n/a	n/a	n/a	n/a	n/a	n/a	
M Metal, End Tables	n/a	n/a	n/a	n/a	n/a	n/a	n/a	n/a	n/a	n/a	n/a	n/a	
U Upholstered, Corner Table	870	966	1064	1160	1256	1354	1546	1546	1644	1168	1694	1869	
U Upholstered, End Tables	870	966	1064	1160	1256	1354	1546	1546	1644	1168	1694	1869	

Table

	Studio	
	Foundation Laminate	Studio Veneer
M Metal, Corner Table	93	290
M Metal, End Tables	186	580
U Upholstered, Corner Table	93	290
U Upholstered, End Tables	186	580

STPT5H clique five-seat bench with table, full back, right run-off

Product Options

Leg Style	Table Style	Seat Upholstery	Back Upholstery	Leg Finish	Table Finish
U Upholstered	C Corner Table	Fabric	Fabric	Fabric	Studio Foundation
M Metal		Leather	Leather	Leather C9 Polished Aluminum Fundamental Paint Fashion Paint	Laminate Studio Veneer

Note For Polished Aluminum, add \$0
 For Fundamental Paint, add \$174
 For Fashion Paint, add \$290

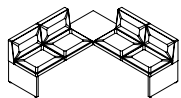

		Seat															
		COM	COL	Gr.1	Gr.2	Gr.3	Gr.4	Gr.5	Gr.6	Gr.7	Gr.8	Gr.9	Gr.10	Gr.11			
M	Metal, Corner Table	7967	8446	8199	8302	8393	8496	8572	8637	8701	8779	8857	8933	9024			
U	Upholstered, Corner Table	8352	8854	8584	8687	8778	8881	8958	9022	9086	9164	9242	9318	9409			
													Leather				
		Gr.12	Gr.13	Gr.14	Gr.15	Gr.16	Gr.17	Gr.18	Gr.19	Gr.20	Gr.9	Gr.10	Gr.11				
M	Metal, Corner Table	9127	9256	9384	9513	9642	9772	9901	10029	10158	9838	10534	10766				
U	Upholstered, Corner Table	9512	9641	9770	9898	10027	10157	10286	10414	10543	10246	10942	11174				
		Back															
		COM	COL	Gr.1	Gr.2	Gr.3	Gr.4	Gr.5	Gr.6	Gr.7	Gr.8	Gr.9	Gr.10	Gr.11			
M	Metal, Corner Table	0	116	232	335	426	529	606	670	734	812	890	966	1057			
U	Upholstered, Corner Table	0	116	232	335	426	529	606	670	734	812	890	966	1057			
													Leather				
		Gr.12	Gr.13	Gr.14	Gr.15	Gr.16	Gr.17	Gr.18	Gr.19	Gr.20	Gr.9	Gr.10	Gr.11				
M	Metal, Corner Table	1160	1289	1418	1546	1675	1805	1934	2062	2191	1508	2204	2436				
U	Upholstered, Corner Table	1160	1289	1418	1546	1675	1805	1934	2062	2191	1508	2204	2436				
		Leg															
		COM	COL	Gr.1	Gr.2	Gr.3	Gr.4	Gr.5	Gr.6	Gr.7	Gr.8	Gr.9	Gr.10	Gr.11			
M	Metal, Corner Table	n/a	n/a	n/a	n/a	n/a	n/a	n/a	n/a	n/a	n/a	n/a	n/a	n/a			
U	Upholstered, Corner Table	0	116	174	252	319	397	455	502	551	609	667	725	792			
													Leather				
		Gr.12	Gr.13	Gr.14	Gr.15	Gr.16	Gr.17	Gr.18	Gr.19	Gr.20	Gr.9	Gr.10	Gr.11				
M	Metal, Corner Table	n/a	n/a	n/a	n/a	n/a	n/a	n/a	n/a	n/a	n/a	n/a	n/a				
U	Upholstered, Corner Table	870	966	1064	1160	1256	1354	1546	1546	1644	1168	1694	1869				
		Table															
		Studio Foundation Laminate	Studio Veneer														
M	Metal, Corner Table	0	58														
U	Upholstered, Corner Table	0	58														

STPT5K clique five-seat bench with table, back with open ends, right run-off

Product Options

Leg Style	Table Style	Seat Upholstery	Back Upholstery	Leg Finish	Table Finish
U Upholstered	E End Tables	Fabric	Fabric	Fabric	Studio Foundation
M Metal		Leather	Leather	Leather C9 Polished Aluminum Fundamental Paint Fashion Paint	Laminate Studio Veneer

Note For Polished Aluminum, add \$0
 For Fundamental Paint, add \$174
 For Fashion Paint, add \$290

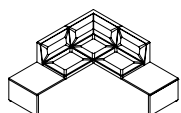

		Seat															
		COM	COL	Gr.1	Gr.2	Gr.3	Gr.4	Gr.5	Gr.6	Gr.7	Gr.8	Gr.9	Gr.10	Gr. 11			
M	Metal, End Tables	7137	7567	7311	7389	7456	7534	7592	7640	7688	7746	7804	7862	7930			
U	Upholstered, End Tables	7424	7871	7598	7676	7743	7821	7879	7926	7975	8033	8091	8149	8216			
													Leather				
													LB	LC	LD		
M	Metal, End Tables	8007	8104	8201	8297	8394	8491	8587	8684	8781		8619	9144	9319			
U	Upholstered, End Tables	8294	8390	8488	8584	8680	8778	8874	8970	9068		8923	9448	9623			
		Back															
		COM	COL	Gr.1	Gr.2	Gr.3	Gr.4	Gr.5	Gr.6	Gr.7	Gr.8	Gr.9	Gr.10	Gr. 11			
M	Metal, End Tables	0	116	232	335	426	529	606	670	734	812	890	966	1057			
U	Upholstered, End Tables	0	116	232	335	426	529	606	670	734	812	890	966	1057			
													Leather				
													LB	LC	LD		
M	Metal, End Tables	1160	1289	1418	1546	1675	1805	1934	2062	2191		1508	2204	2436			
U	Upholstered, End Tables	1160	1289	1418	1546	1675	1805	1934	2062	2191		1508	2204	2436			
		Leg															
		COM	COL	Gr.1	Gr.2	Gr.3	Gr.4	Gr.5	Gr.6	Gr.7	Gr.8	Gr.9	Gr.10	Gr. 11			
M	Metal, End Tables	n/a	n/a	n/a	n/a	n/a	n/a	n/a	n/a	n/a	n/a	n/a	n/a	n/a			
U	Upholstered, End Tables	0	116	174	252	319	397	455	502	551	609	667	725	792			
													Leather				
													LB	LC	LD		
M	Metal, End Tables	n/a	n/a	n/a	n/a	n/a	n/a	n/a	n/a	n/a	n/a	n/a	n/a	n/a			
U	Upholstered, End Tables	870	966	1064	1160	1256	1354	1546	1546	1644		1168	1694	1869			
		Table															
		Studio Foundation Laminate											Studio Veneer				
M	Metal, End Tables	186											580				
U	Upholstered, End Tables	186											580				

STPT6C clique six-seat bench with table, no back, left run-off

Product Options

Leg Style	Table Style	Seat Upholstery	Leg Finish	Table Finish
U Upholstered	C Corner Table	Fabric	Fabric	Studio Foundation
M Metal	E End Tables	Leather	Leather	Laminate
			C9 Polished Aluminum	Studio Veneer
			Fundamental Paint	
			Fashion Paint	

Note For Polished Aluminum, add \$0
 For Fundamental Paint, add \$174
 For Fashion Paint, add \$290

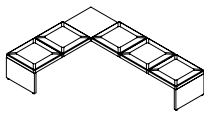

	Seat												
	COM	COL	Gr.1	Gr.2	Gr.3	Gr.4	Gr.5	Gr.6	Gr.7	Gr.8	Gr.9	Gr.10	Gr. 11
M Metal, Corner Table	5526	5858	5816	5945	6058	6186	6284	6364	6445	6541	6638	6735	6847
M Metal, End Tables	5526	5858	5758	5861	5952	6055	6132	6197	6261	6338	6416	6493	6583
U Upholstered, Corner Table	5911	6266	6201	6330	6443	6571	6669	6749	6830	6926	7023	7120	7233
U Upholstered, End Tables	5911	6266	6143	6247	6337	6440	6517	6582	6646	6723	6801	6878	6968

											Leather		
	Gr.12	Gr.13	Gr.14	Gr.15	Gr.16	Gr.17	Gr.18	Gr.19	Gr.20		LB	LC	LD
M Metal, Corner Table	6976	7137	7299	7460	7621	7781	7943	8104	8265		7606	8480	8771
M Metal, End Tables	6686	6815	6944	7073	7201	7331	7460	7589	7717		7250	7946	8178
U Upholstered, Corner Table	7361	7523	7684	7845	8006	8166	8328	8489	8650		8014	8888	9179
U Upholstered, End Tables	7071	7200	7329	7458	7586	7716	7845	7974	8103		7658	8354	8586

	Leg												
	COM	COL	Gr.1	Gr.2	Gr.3	Gr.4	Gr.5	Gr.6	Gr.7	Gr.8	Gr.9	Gr.10	Gr. 11
M Metal, Corner Table	n/a	n/a	n/a	n/a	n/a	n/a	n/a	n/a	n/a	n/a	n/a	n/a	n/a
M Metal, End Tables	n/a	n/a	n/a	n/a	n/a	n/a	n/a	n/a	n/a	n/a	n/a	n/a	n/a
U Upholstered, Corner Table	0	116	174	252	319	397	455	502	551	609	667	725	792
U Upholstered, End Tables	0	116	174	252	319	397	455	502	551	609	667	725	792

											Leather		
	Gr.12	Gr.13	Gr.14	Gr.15	Gr.16	Gr.17	Gr.18	Gr.19	Gr.20		LB	LC	LD
M Metal, Corner Table	n/a	n/a	n/a	n/a	n/a	n/a	n/a	n/a	n/a		n/a	n/a	n/a
M Metal, End Tables	n/a	n/a	n/a	n/a	n/a	n/a	n/a	n/a	n/a		n/a	n/a	n/a
U Upholstered, Corner Table	870	966	1064	1160	1256	1354	1546	1546	1644		1168	1694	1869
U Upholstered, End Tables	870	966	1064	1160	1256	1354	1546	1546	1644		1168	1694	1869

Table

	Studio	
	Foundation Laminate	Studio Veneer
M Metal, Corner Table	93	290
M Metal, End Tables	186	580
U Upholstered, Corner Table	93	290
U Upholstered, End Tables	186	580

STPT6D clique six-seat bench with table, full back, left run-off

Product Options

Leg Style	Table Style	Seat Upholstery	Back Upholstery	Leg Finish	Table Finish
U Upholstered	C Corner Table	Fabric	Fabric	Fabric	Studio Foundation
M Metal		Leather	Leather	Leather C9 Polished Aluminum Fundamental Paint Fashion Paint	Laminate Studio Veneer

Note For Polished Aluminum, add \$0
 For Fundamental Paint, add \$174
 For Fashion Paint, add \$290

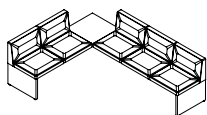

		Seat															
		COM	COL	Gr.1	Gr.2	Gr.3	Gr.4	Gr.5	Gr.6	Gr.7	Gr.8	Gr.9	Gr.10	Gr.11			
M	Metal, Corner Table	8738	9264	9028	9157	9270	9398	9496	9576	9657	9753	9850	9947	10060			
U	Upholstered, Corner Table	9125	9673	9415	9543	9656	9785	9882	9962	10043	10140	10236	10333	10446			
													Leather				
		Gr.12	Gr.13	Gr.14	Gr.15	Gr.16	Gr.17	Gr.18	Gr.19	Gr.20	LB	LC	LD				
M	Metal, Corner Table	10188	10350	10511	10672	10833	10993	11155	11316	11477	11012	11885	12177				
U	Upholstered, Corner Table	10575	10736	10897	11058	11220	11380	11541	11702	11863	11421	12295	12586				
		Back															
		COM	COL	Gr.1	Gr.2	Gr.3	Gr.4	Gr.5	Gr.6	Gr.7	Gr.8	Gr.9	Gr.10	Gr.11			
M	Metal, Corner Table	0	116	290	419	531	660	757	838	919	1015	1111	1209	1321			
U	Upholstered, Corner Table	0	116	290	419	531	660	757	838	919	1015	1111	1209	1321			
													Leather				
		Gr.12	Gr.13	Gr.14	Gr.15	Gr.16	Gr.17	Gr.18	Gr.19	Gr.20	LB	LC	LD				
M	Metal, Corner Table	1450	1611	1772	1934	2095	2255	2416	2578	2739	1864	2738	3029				
U	Upholstered, Corner Table	1450	1611	1772	1934	2095	2255	2416	2578	2739	1864	2738	3029				
		Leg															
		COM	COL	Gr.1	Gr.2	Gr.3	Gr.4	Gr.5	Gr.6	Gr.7	Gr.8	Gr.9	Gr.10	Gr.11			
M	Metal, Corner Table	n/a	n/a	n/a	n/a	n/a	n/a	n/a	n/a	n/a	n/a	n/a	n/a	n/a			
U	Upholstered, Corner Table	0	116	174	252	319	397	455	502	551	609	667	725	792			
													Leather				
		Gr.12	Gr.13	Gr.14	Gr.15	Gr.16	Gr.17	Gr.18	Gr.19	Gr.20	LB	LC	LD				
M	Metal, Corner Table	n/a	n/a	n/a	n/a	n/a	n/a	n/a	n/a	n/a	n/a	n/a	n/a				
U	Upholstered, Corner Table	758	966	1064	1160	1256	1354	1546	1546	1644	1168	1694	1869				
		Table															
		Studio Foundation Laminate		Studio Veneer													
M	Metal, Corner Table	0		58													
U	Upholstered, Corner Table	0		58													

STPT6F clique six-seat bench with table, back with open ends, left run-off

Product Options

Leg Style	Table Style	Seat Upholstery	Back Upholstery	Leg Finish	Table Finish
U Upholstered	E End Tables	Fabric	Fabric	Fabric	Studio Foundation
M Metal		Leather	Leather	Leather C9 Polished Aluminum Fundamental Paint Fashion Paint	Laminate Studio Veneer

Note For Polished Aluminum, add \$0
 For Fundamental Paint, add \$174
 For Fashion Paint, add \$290

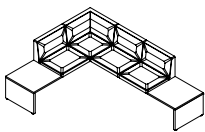

		Seat												
		COM	COL	Gr.1	Gr.2	Gr.3	Gr.4	Gr.5	Gr.6	Gr.7	Gr.8	Gr.9	Gr.10	Gr. 11
M	Metal, End Tables	7909	8384	8141	8244	8335	8438	8514	8579	8643	8721	8799	8875	8966
U	Upholstered, End Tables	8194	8687	8426	8529	8620	8723	8800	8865	8929	9006	9084	9161	9251
												Leather		
		Gr.12	Gr.13	Gr.14	Gr.15	Gr.16	Gr.17	Gr.18	Gr.19	Gr.20	LB	LC	LD	
M	Metal, End Tables	9069	9198	9326	9455	9584	9714	9843	9971	10100	9776	10472	10704	
U	Upholstered, End Tables	9354	9483	9612	9741	9869	9999	10128	10257	10385	10079	10775	11007	
		Back												
		COM	COL	Gr.1	Gr.2	Gr.3	Gr.4	Gr.5	Gr.6	Gr.7	Gr.8	Gr.9	Gr.10	Gr. 11
M	Metal, End Tables	0	116	290	419	531	660	757	838	919	1015	1111	1209	1321
U	Upholstered, End Tables	0	116	290	419	531	660	757	838	919	1015	1111	1209	1321
												Leather		
		Gr.12	Gr.13	Gr.14	Gr.15	Gr.16	Gr.17	Gr.18	Gr.19	Gr.20	LB	LC	LD	
M	Metal, End Tables	1450	1611	1772	1934	2095	2255	2416	2578	2739	1864	2738	3029	
U	Upholstered, End Tables	1450	1611	1772	1934	2095	2255	2416	2578	2739	1864	2738	3029	
		Leg												
		COM	COL	Gr.1	Gr.2	Gr.3	Gr.4	Gr.5	Gr.6	Gr.7	Gr.8	Gr.9	Gr.10	Gr. 11
M	Metal, End Tables	n/a	n/a	n/a	n/a	n/a	n/a	n/a	n/a	n/a	n/a	n/a	n/a	n/a
U	Upholstered, End Tables	0	116	174	252	319	397	455	502	551	609	667	725	792
												Leather		
		Gr.12	Gr.13	Gr.14	Gr.15	Gr.16	Gr.17	Gr.18	Gr.19	Gr.20	LB	LC	LD	
M	Metal, End Tables	n/a	n/a	n/a	n/a	n/a	n/a	n/a	n/a	n/a	n/a	n/a	n/a	
U	Upholstered, End Tables	870	966	1064	1160	1256	1354	1546	1546	1644	1168	1694	1869	
		Table												
		Studio												
		Foundation	Studio											
		Laminate	Veneer											
M	Metal, End Tables	186	580											
U	Upholstered, End Tables	186	580											

STPT6G clique six-seat bench with table, no back, right run-off

Product Options

Leg Style	Table Style	Seat Upholstery	Leg Finish	Table Finish
U Upholstered	C Corner Table	Fabric	Fabric	Studio Foundation
M Metal	E End Tables	Leather	Leather	Laminate
			C9 Polished Aluminum	Studio Veneer
			Fundamental Paint	
			Fashion Paint	

Note For Polished Aluminum, add \$0
 For Fundamental Paint, add \$174
 For Fashion Paint, add \$290

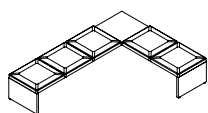

	Seat												
	COM	COL	Gr.1	Gr.2	Gr.3	Gr.4	Gr.5	Gr.6	Gr.7	Gr.8	Gr.9	Gr.10	Gr.11
M Metal, Corner Table	5526	5858	5816	5945	6058	6186	6284	6364	6445	6541	6638	6735	6847
M Metal, End Tables	5526	5858	5758	5861	5952	6055	6132	6197	6261	6338	6416	6493	6583
U Upholstered, Corner Table	5911	6266	6201	6330	6443	6571	6669	6749	6830	6926	7023	7120	7233
U Upholstered, End Tables	5911	6266	6143	6247	6337	6440	6517	6582	6646	6723	6801	6878	6968

											Leather		
	Gr.12	Gr.13	Gr.14	Gr.15	Gr.16	Gr.17	Gr.18	Gr.19	Gr.20		LB	LC	LD
M Metal, Corner Table	6976	7137	7299	7460	7621	7781	7943	8104	8265		7606	8480	8771
M Metal, End Tables	6686	6815	6944	7073	7201	7331	7460	7589	7717		7250	7946	8178
U Upholstered, Corner Table	7361	7523	7684	7845	8006	8166	8328	8489	8650		8014	8888	9179
U Upholstered, End Tables	7071	7200	7329	7458	7586	7716	7845	7974	8103		7658	8354	8586

	Leg												
	COM	COL	Gr.1	Gr.2	Gr.3	Gr.4	Gr.5	Gr.6	Gr.7	Gr.8	Gr.9	Gr.10	Gr.11
M Metal, Corner Table	n/a	n/a	n/a	n/a	n/a	n/a	n/a	n/a	n/a	n/a	n/a	n/a	n/a
M Metal, End Tables	n/a	n/a	n/a	n/a	n/a	n/a	n/a	n/a	n/a	n/a	n/a	n/a	n/a
U Upholstered, Corner Table	0	116	174	252	319	397	455	502	551	609	667	725	792
U Upholstered, End Tables	0	116	174	252	319	397	455	502	551	609	667	725	792

											Leather		
	Gr.12	Gr.13	Gr.14	Gr.15	Gr.16	Gr.17	Gr.18	Gr.19	Gr.20		LB	LC	LD
M Metal, Corner Table	n/a	n/a	n/a	n/a	n/a	n/a	n/a	n/a	n/a		n/a	n/a	n/a
M Metal, End Tables	n/a	n/a	n/a	n/a	n/a	n/a	n/a	n/a	n/a		n/a	n/a	n/a
U Upholstered, Corner Table	870	966	1064	1160	1256	1354	1546	1546	1644		1168	1694	1869
U Upholstered, End Tables	870	966	1064	1160	1256	1354	1546	1546	1644		1168	1694	1869

Table

	Studio	
	Foundation Laminate	Studio Veneer
M Metal, Corner Table	93	290
M Metal, End Tables	186	580
U Upholstered, Corner Table	93	290
U Upholstered, End Tables	186	580

STPT6H clique six-seat bench with table, full back, right run-off

Product Options

Leg Style	Table Style	Seat Upholstery	Back Upholstery	Leg Finish	Table Finish
U Upholstered	C Corner Table	Fabric	Fabric	Fabric	Studio Foundation
M Metal		Leather	Leather	Leather C9 Polished Aluminum Fundamental Paint Fashion Paint	Laminate Studio Veneer

Note For Polished Aluminum, add \$0
For Fundamental Paint, add \$174
For Fashion Paint, add \$290

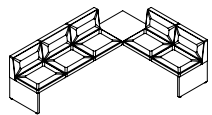

		Seat															
		COM	COL	Gr.1	Gr.2	Gr.3	Gr.4	Gr.5	Gr.6	Gr.7	Gr.8	Gr.9	Gr.10	Gr. 11			
M	Metal, Corner Table	8738	9264	9028	9157	9270	9398	9496	9576	9657	9753	9850	9947	10060			
U	Upholstered, Corner Table	9125	9673	9415	9543	9656	9785	9882	9962	10043	10140	10236	10333	10446			
													Leather				
		Gr.12	Gr.13	Gr.14	Gr.15	Gr.16	Gr.17	Gr.18	Gr.19	Gr.20	Gr.9	Gr.10	Gr.11				
M	Metal, Corner Table	10188	10350	10511	10672	10833	10993	11155	11316	11477	11012	11885	12177				
U	Upholstered, Corner Table	10575	10736	10897	11058	11220	11380	11541	11702	11863	11421	12295	12586				
		Back															
		COM	COL	Gr.1	Gr.2	Gr.3	Gr.4	Gr.5	Gr.6	Gr.7	Gr.8	Gr.9	Gr.10	Gr. 11			
M	Metal, Corner Table	0	116	290	419	531	660	757	838	919	1015	1111	1209	1321			
U	Upholstered, Corner Table	0	116	290	419	531	660	757	838	919	1015	1111	1209	1321			
													Leather				
		Gr.12	Gr.13	Gr.14	Gr.15	Gr.16	Gr.17	Gr.18	Gr.19	Gr.20	Gr.9	Gr.10	Gr.11				
M	Metal, Corner Table	1450	1611	1772	1934	2095	2255	2416	2578	2739	1864	2738	3029				
U	Upholstered, Corner Table	1450	1611	1772	1934	2095	2255	2416	2578	2739	1864	2738	3029				
		Leg															
		COM	COL	Gr.1	Gr.2	Gr.3	Gr.4	Gr.5	Gr.6	Gr.7	Gr.8	Gr.9	Gr.10	Gr. 11			
M	Metal, Corner Table	n/a	n/a	n/a	n/a	n/a	n/a	n/a	n/a	n/a	n/a	n/a	n/a	n/a			
U	Upholstered, Corner Table	0	116	174	252	319	397	455	502	551	609	667	725	792			
													Leather				
		Gr.12	Gr.13	Gr.14	Gr.15	Gr.16	Gr.17	Gr.18	Gr.19	Gr.20	Gr.9	Gr.10	Gr.11				
M	Metal, Corner Table	n/a	n/a	n/a	n/a	n/a	n/a	n/a	n/a	n/a	n/a	n/a	n/a				
U	Upholstered, Corner Table	870	966	1064	1160	1256	1354	1546	1546	1644	1168	1694	1869				
		Table															
		Studio															
		Foundation	Studio														
		Laminate	Veneer														
M	Metal, Corner Table	0	58														
U	Upholstered, Corner Table	0	58														

STPT6K clique six-seat bench with table, back with open run-off, right run-off

Product Options

Leg Style	Table Style	Seat Upholstery	Back Upholstery	Leg Finish	Table Finish
U Upholstered	E End Tables	Fabric	Fabric	Fabric	Studio Foundation
M Metal		Leather	Leather	Leather C9 Polished Aluminum Fundamental Paint Fashion Paint	Laminate Studio Veneer

Note For Polished Aluminum, add \$0
 For Fundamental Paint, add \$174
 For Fashion Paint, add \$290

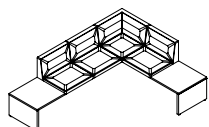

		Seat															
		COM	COL	Gr.1	Gr.2	Gr.3	Gr.4	Gr.5	Gr.6	Gr.7	Gr.8	Gr.9	Gr.10	Gr. 11			
M	Metal, End Tables	7909	8384	8141	8244	8335	8438	8514	8579	8643	8721	8799	8875	8966			
U	Upholstered, End Tables	8194	8687	8426	8529	8620	8723	8800	8865	8929	9006	9084	9161	9251			
													Leather				
		Gr.12	Gr.13	Gr.14	Gr.15	Gr.16	Gr.17	Gr.18	Gr.19	Gr.20	Gr.9	Gr.10	Gr.11	Gr.12	Gr.13	Gr.14	
M	Metal, End Tables	9069	9198	9326	9455	9584	9714	9843	9971	10100	9776	10472	10704	9776	10472	10704	
U	Upholstered, End Tables	9354	9483	9612	9741	9869	9999	10128	10257	10385	10079	10775	11007	10079	10775	11007	
		Back															
		COM	COL	Gr.1	Gr.2	Gr.3	Gr.4	Gr.5	Gr.6	Gr.7	Gr.8	Gr.9	Gr.10	Gr. 11			
M	Metal, End Tables	0	116	290	419	531	660	757	838	919	1015	1111	1209	1321			
U	Upholstered, End Tables	0	116	290	419	531	660	757	838	919	1015	1111	1209	1321			
													Leather				
		Gr.12	Gr.13	Gr.14	Gr.15	Gr.16	Gr.17	Gr.18	Gr.19	Gr.20	Gr.9	Gr.10	Gr.11	Gr.12	Gr.13	Gr.14	
M	Metal, End Tables	1450	1611	1772	1934	2095	2255	2416	2578	2739	1864	2738	3029	1864	2738	3029	
U	Upholstered, End Tables	1450	1611	1772	1934	2095	2255	2416	2578	2739	1864	2738	3029	1864	2738	3029	
		Leg															
		COM	COL	Gr.1	Gr.2	Gr.3	Gr.4	Gr.5	Gr.6	Gr.7	Gr.8	Gr.9	Gr.10	Gr. 11			
M	Metal, End Tables	n/a	n/a	n/a	n/a	n/a	n/a	n/a	n/a	n/a	n/a	n/a	n/a	n/a			
U	Upholstered, End Tables	0	116	174	252	319	397	455	502	551	609	667	725	792			
													Leather				
		Gr.12	Gr.13	Gr.14	Gr.15	Gr.16	Gr.17	Gr.18	Gr.19	Gr.20	Gr.9	Gr.10	Gr.11	Gr.12	Gr.13	Gr.14	
M	Metal, End Tables	n/a	n/a	n/a	n/a	n/a	n/a	n/a	n/a	n/a	n/a	n/a	n/a	n/a	n/a	n/a	
U	Upholstered, End Tables	870	966	1064	1160	1256	1354	1546	1546	1644	1168	1694	1869	1168	1694	1869	
		Table															
		Studio Foundation Laminate		Studio Veneer													
M	Metal, End Tables	186		580													
U	Upholstered, End Tables	186		580													

STPT7C clique seven-seat bench with table, no back, left run-off

Product Options

Leg Style	Table Style	Seat Upholstery	Leg Finish	Table Finish
U Upholstered	C Corner Table	Fabric	Fabric	Studio Foundation
M Metal	E End Tables	Leather	Leather	Laminate
			C9 Polished Aluminum	Studio Veneer
			Fundamental Paint	
			Fashion Paint	

Note For Polished Aluminum, add \$0
 For Fundamental Paint, add \$174
 For Fashion Paint, add \$290

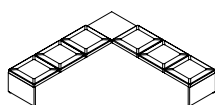

	Seat												
	COM	COL	Gr.1	Gr.2	Gr.3	Gr.4	Gr.5	Gr.6	Gr.7	Gr.8	Gr.9	Gr.10	Gr.11
M Metal, Corner Table	6298	6676	6646	6800	6936	7090	7206	7303	7400	7516	7632	7748	7883
M Metal, End Tables	6298	6676	6588	6716	6829	6958	7055	7135	7216	7313	7409	7506	7619
U Upholstered, Corner Table	6683	7084	7031	7185	7321	7475	7591	7688	7785	7901	8017	8133	8268
U Upholstered, End Tables	6683	7084	6973	7102	7214	7343	7440	7520	7601	7698	7794	7891	8004

											Leather		
	Gr.12	Gr.13	Gr.14	Gr.15	Gr.16	Gr.17	Gr.18	Gr.19	Gr.20	LB	LC	LD	
M Metal, Corner Table	8038	8231	8424	8618	8811	9004	9198	9391	9584	8764	9808	10156	
M Metal, End Tables	7748	7909	8070	8231	8393	8553	8714	8875	9036	8424	9297	9589	
U Upholstered, Corner Table	8423	8616	8809	9003	9196	9389	9583	9776	9969	9172	10216	10564	
U Upholstered, End Tables	8133	8294	8455	8616	8778	8938	9099	9260	9422	8832	9706	9997	

	Leg												
	COM	COL	Gr.1	Gr.2	Gr.3	Gr.4	Gr.5	Gr.6	Gr.7	Gr.8	Gr.9	Gr.10	Gr.11
M Metal, Corner Table	n/a	n/a	n/a	n/a	n/a	n/a	n/a	n/a	n/a	n/a	n/a	n/a	n/a
M Metal, End Tables	n/a	n/a	n/a	n/a	n/a	n/a	n/a	n/a	n/a	n/a	n/a	n/a	n/a
U Upholstered, Corner Table	0	116	174	252	319	397	455	502	551	609	667	725	792
U Upholstered, End Tables	0	116	174	252	319	397	455	502	551	609	667	725	792

											Leather		
	Gr.12	Gr.13	Gr.14	Gr.15	Gr.16	Gr.17	Gr.18	Gr.19	Gr.20	LB	LC	LD	
M Metal, Corner Table	n/a	n/a	n/a	n/a	n/a	n/a	n/a	n/a	n/a	n/a	n/a	n/a	
M Metal, End Tables	n/a	n/a	n/a	n/a	n/a	n/a	n/a	n/a	n/a	n/a	n/a	n/a	
U Upholstered, Corner Table	870	966	1064	1160	1256	1354	1546	1546	1644	1168	1694	1869	
U Upholstered, End Tables	870	966	1064	1160	1256	1354	1546	1546	1644	1168	1694	1869	

Table

	Studio	
	Foundation Laminate	Studio Veneer
M Metal, Corner Table	93	290
M Metal, End Tables	186	580
U Upholstered, Corner Table	93	290
U Upholstered, End Tables	186	580

STPT7D clique seven-seat bench with table, full back, left run-off

Product Options

Leg Style	Table Style	Seat Upholstery	Back Upholstery	Leg Finish	Table Finish
U Upholstered	C Corner Table	Fabric	Fabric	Fabric	Studio Foundation
M Metal		Leather	Leather	Leather C9 Polished Aluminum Fundamental Paint Fashion Paint	Laminate Studio Veneer

Note For Polished Aluminum, add \$0
 For Fundamental Paint, add \$174
 For Fashion Paint, add \$290

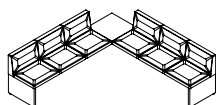

		Seat															
		COM	COL	Gr.1	Gr.2	Gr.3	Gr.4	Gr.5	Gr.6	Gr.7	Gr.8	Gr.9	Gr.10	Gr. 11			
M	Metal, Corner Table	9509	10080	9857	10011	10147	10301	10417	10514	10611	10727	10843	10959	11094			
U	Upholstered, Corner Table	9895	10490	10243	10397	10533	10687	10803	10901	10997	11113	11229	11345	11481			
													Leather				
		Gr.12	Gr.13	Gr.14	Gr.15	Gr.16	Gr.17	Gr.18	Gr.19	Gr.20	LB	LC	LD				
M	Metal, Corner Table	11249	11442	11635	11829	12022	12215	12409	12602	12795	12168	13212	13560				
U	Upholstered, Corner Table	11635	11829	12021	12215	12409	12601	12795	12989	13181	12578	13622	13970				

		Back															
		COM	COL	Gr.1	Gr.2	Gr.3	Gr.4	Gr.5	Gr.6	Gr.7	Gr.8	Gr.9	Gr.10	Gr. 11			
M	Metal, Corner Table	0	116	348	502	638	792	908	1006	1102	1218	1334	1450	1586			
U	Upholstered, Corner Table	0	116	348	502	638	792	908	1006	1102	1218	1334	1450	1586			
													Leather				
		Gr.12	Gr.13	Gr.14	Gr.15	Gr.16	Gr.17	Gr.18	Gr.19	Gr.20	LB	LC	LD				
M	Metal, Corner Table	1740	1934	2126	2320	2514	2706	2900	3094	3286	2204	3248	3596				
U	Upholstered, Corner Table	1740	1934	2126	2320	2514	2706	2900	3094	3286	2204	3248	3596				

		Leg															
		COM	COL	Gr.1	Gr.2	Gr.3	Gr.4	Gr.5	Gr.6	Gr.7	Gr.8	Gr.9	Gr.10	Gr. 11			
M	Metal, Corner Table	n/a	n/a	n/a	n/a	n/a	n/a	n/a	n/a	n/a	n/a	n/a	n/a	n/a			
U	Upholstered, Corner Table	0	116	174	252	319	397	455	502	551	609	667	725	792			
													Leather				
		Gr.12	Gr.13	Gr.14	Gr.15	Gr.16	Gr.17	Gr.18	Gr.19	Gr.20	LB	LC	LD				
M	Metal, Corner Table	n/a	n/a	n/a	n/a	n/a	n/a	n/a	n/a	n/a	n/a	n/a	n/a				
U	Upholstered, Corner Table	870	966	1064	1160	1256	1354	1546	1546	1644	1168	1694	1869				

		Table	
		Studio Foundation Laminate	Studio Veneer
M	Metal, Corner Table	0	58
U	Upholstered, Corner Table	0	58

STPT7F clique seven-seat bench with table, back with open ends, left run-off

Product Options

Leg Style	Table Style	Seat Upholstery	Back Upholstery	Leg Finish	Table Finish
U Upholstered	E End Tables	Fabric	Fabric	Fabric	Studio Foundation
M Metal		Leather	Leather	Leather C9 Polished Aluminum Fundamental Paint Fashion Paint	Laminate Studio Veneer

Note For Polished Aluminum, add \$0
 For Fundamental Paint, add \$174
 For Fashion Paint, add \$290

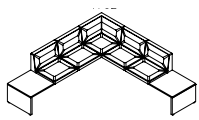

		Seat												
		COM	COL	Gr.1	Gr.2	Gr.3	Gr.4	Gr.5	Gr.6	Gr.7	Gr.8	Gr.9	Gr.10	Gr. 11
M	Metal, End Tables	8680	9202	8970	9099	9212	9340	9438	9518	9599	9695	9792	9889	10002
U	Upholstered, End Tables	8967	9506	9257	9386	9498	9627	9724	9804	9886	9982	10078	10176	10288
												Leather		
		Gr.12	Gr.13	Gr.14	Gr.15	Gr.16	Gr.17	Gr.18	Gr.19	Gr.20	LB	LC	LD	
M	Metal, End Tables	10130	10292	10453	10614	10775	10935	11097	11258	11419	10950	11824	12115	
U	Upholstered, End Tables	10417	10578	10739	10901	11062	11222	11383	11544	11706	11254	12128	12419	
		Back												
		COM	COL	Gr.1	Gr.2	Gr.3	Gr.4	Gr.5	Gr.6	Gr.7	Gr.8	Gr.9	Gr.10	Gr. 11
M	Metal, End Tables	0	116	348	502	638	792	908	1006	1102	1218	1334	1450	1586
U	Upholstered, End Tables	0	116	348	502	638	792	908	1006	1102	1218	1334	1450	1586
												Leather		
		Gr.12	Gr.13	Gr.14	Gr.15	Gr.16	Gr.17	Gr.18	Gr.19	Gr.20	LB	LC	LD	
M	Metal, End Tables	1740	1934	2126	2320	2514	2706	2900	3094	3286	2204	3248	3596	
U	Upholstered, End Tables	1740	1934	2126	2320	2514	2706	2900	3094	3286	2204	3248	3596	
		Leg												
		COM	COL	Gr.1	Gr.2	Gr.3	Gr.4	Gr.5	Gr.6	Gr.7	Gr.8	Gr.9	Gr.10	Gr. 11
M	Metal, End Tables	n/a	n/a	n/a	n/a	n/a	n/a	n/a	n/a	n/a	n/a	n/a	n/a	n/a
U	Upholstered, End Tables	0	116	174	252	319	397	455	502	551	609	667	725	792
												Leather		
		Gr.12	Gr.13	Gr.14	Gr.15	Gr.16	Gr.17	Gr.18	Gr.19	Gr.20	LB	LC	LD	
M	Metal, End Tables	n/a	n/a	n/a	n/a	n/a	n/a	n/a	n/a	n/a	n/a	n/a	n/a	
U	Upholstered, End Tables	870	966	1064	1160	1256	1354	1546	1546	1644	1168	1694	1869	
		Table												
		Studio												
		Foundation	Studio											
		Laminate	Veneer											
M	Metal, End Tables	186	580											
U	Upholstered, End Tables	186	580											

STPT7G clique seven-seat bench with table, no back, right run-off

Product Options

Leg Style	Table Style	Seat Upholstery	Leg Finish	Table Finish
U Upholstered	C Corner Table	Fabric	Fabric	Studio Foundation
M Metal	E End Tables	Leather	Leather	Laminate
			C9 Polished Aluminum	Studio Veneer
			Fundamental Paint	
			Fashion Paint	

Note For Polished Aluminum, add \$0
 For Fundamental Paint, add \$174
 For Fashion Paint, add \$290

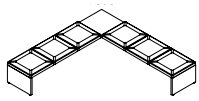

		Seat												
		COM	COL	Gr.1	Gr.2	Gr.3	Gr.4	Gr.5	Gr.6	Gr.7	Gr.8	Gr.9	Gr.10	Gr. 11
M	Metal, Corner Table	6298	6676	6646	6800	6936	7090	7206	7303	7400	7516	7632	7748	7883
M	Metal, End Tables	6298	6676	6588	6716	6829	6958	7055	7135	7216	7313	7409	7506	7619
U	Upholstered, Corner Table	6683	7084	7031	7185	7321	7475	7591	7688	7785	7901	8017	8133	8268
U	Upholstered, End Tables	6683	7084	6973	7102	7214	7343	7440	7520	7601	7698	7794	7891	8004

												Leather		
		Gr.12	Gr.13	Gr.14	Gr.15	Gr.16	Gr.17	Gr.18	Gr.19	Gr.20	LB	LC	LD	
M	Metal, Corner Table	8038	8231	8424	8618	8811	9004	9198	9391	9584	8764	9808	10156	
M	Metal, End Tables	7748	7909	8070	8231	8393	8553	8714	8875	9036	8424	9297	9589	
U	Upholstered, Corner Table	8423	8616	8809	9003	9196	9389	9583	9776	9969	9172	10216	10564	
U	Upholstered, End Tables	8133	8294	8455	8616	8778	8938	9099	9260	9422	8832	9706	9997	

		Leg												
		COM	COL	Gr.1	Gr.2	Gr.3	Gr.4	Gr.5	Gr.6	Gr.7	Gr.8	Gr.9	Gr.10	Gr. 11
M	Metal, Corner Table	n/a	n/a	n/a	n/a	n/a	n/a	n/a	n/a	n/a	n/a	n/a	n/a	n/a
M	Metal, End Tables	n/a	n/a	n/a	n/a	n/a	n/a	n/a	n/a	n/a	n/a	n/a	n/a	n/a
U	Upholstered, Corner Table	0	116	174	252	319	397	455	502	551	609	667	725	792
U	Upholstered, End Tables	0	116	174	252	319	397	455	502	551	609	667	725	792

												Leather		
		Gr.12	Gr.13	Gr.14	Gr.15	Gr.16	Gr.17	Gr.18	Gr.19	Gr.20	LB	LC	LD	
M	Metal, Corner Table	n/a	n/a	n/a	n/a	n/a	n/a	n/a	n/a	n/a	n/a	n/a	n/a	
M	Metal, End Tables	n/a	n/a	n/a	n/a	n/a	n/a	n/a	n/a	n/a	n/a	n/a	n/a	
U	Upholstered, Corner Table	870	966	1064	1160	1256	1354	1546	1546	1644	1168	1694	1869	
U	Upholstered, End Tables	870	966	1064	1160	1256	1354	1546	1546	1644	1168	1694	1869	

		Table	
		Studio	
		Foundation Laminate	Studio Veneer
M	Metal, Corner Table	93	290
M	Metal, End Tables	186	580
U	Upholstered, Corner Table	93	290
U	Upholstered, End Tables	186	580

STPT7H clique seven-seat bench with table, full back, right run-off

Product Options

Leg Style	Table Style	Seat Upholstery	Back Upholstery	Leg Finish	Table Finish
U Upholstered	C Corner Table	Fabric	Fabric	Fabric	Studio Foundation
M Metal		Leather	Leather	Leather C9 Polished Aluminum Fundamental Paint Fashion Paint	Laminate Studio Veneer

Note For Polished Aluminum, add \$0
 For Fundamental Paint, add \$174
 For Fashion Paint, add \$290

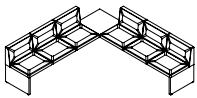

		Seat												
		COM	COL	Gr.1	Gr.2	Gr.3	Gr.4	Gr.5	Gr.6	Gr.7	Gr.8	Gr.9	Gr.10	Gr.11
M	Metal, Corner Table	9509	10080	9857	10011	10147	10301	10417	10514	10611	10727	10843	10959	11094
U	Upholstered, Corner Table	9895	10490	10243	10397	10533	10687	10803	10901	10997	11113	11229	11345	11481
												Leather		
		Gr.12	Gr.13	Gr.14	Gr.15	Gr.16	Gr.17	Gr.18	Gr.19	Gr.20	LB	LC	LD	
M	Metal, Corner Table	11249	11442	11635	11829	12022	12215	12409	12602	12795	12168	13212	13560	
U	Upholstered, Corner Table	11635	11829	12021	12215	12409	12601	12795	12989	13181	12578	13622	13970	
		Back												
		COM	COL	Gr.1	Gr.2	Gr.3	Gr.4	Gr.5	Gr.6	Gr.7	Gr.8	Gr.9	Gr.10	Gr.11
M	Metal, Corner Table	0	116	348	502	638	792	908	1006	1102	1218	1334	1450	1586
U	Upholstered, Corner Table	0	116	348	502	638	792	908	1006	1102	1218	1334	1450	1586
												Leather		
		Gr.12	Gr.13	Gr.14	Gr.15	Gr.16	Gr.17	Gr.18	Gr.19	Gr.20	LB	LC	LD	
M	Metal, Corner Table	1740	1934	2126	2320	2514	2706	2900	3094	3286	2204	3248	3596	
U	Upholstered, Corner Table	1740	1934	2126	2320	2514	2706	2900	3094	3286	2204	3248	3596	
		Leg												
		COM	COL	Gr.1	Gr.2	Gr.3	Gr.4	Gr.5	Gr.6	Gr.7	Gr.8	Gr.9	Gr.10	Gr.11
M	Metal, Corner Table	n/a	n/a	n/a	n/a	n/a	n/a	n/a	n/a	n/a	n/a	n/a	n/a	n/a
U	Upholstered, Corner Table	0	116	174	252	319	397	455	502	551	609	667	725	792
												Leather		
		Gr.12	Gr.13	Gr.14	Gr.15	Gr.16	Gr.17	Gr.18	Gr.19	Gr.20	LB	LC	LD	
M	Metal, Corner Table	n/a	n/a	n/a	n/a	n/a	n/a	n/a	n/a	n/a	n/a	n/a	n/a	
U	Upholstered, Corner Table	870	966	1064	1160	1256	1354	1546	1546	1644	1168	1694	1869	
		Table												
		Studio												
		Foundation	Studio											
		Laminate	Veneer											
M	Metal, Corner Table	0	58											
U	Upholstered, Corner Table	0	58											

STPT7K clique seven-seat bench with table, back with open ends, right run-off

Product Options

Leg Style	Table Style	Seat Upholstery	Back Upholstery	Leg Finish	Table Finish
U Upholstered	E End Tables	Fabric	Fabric	Fabric	Studio Foundation
M Metal		Leather	Leather	Leather C9 Polished Aluminum Fundamental Paint Fashion Paint	Laminate Studio Veneer

Note For Polished Aluminum, add \$0
 For Fundamental Paint, add \$174
 For Fashion Paint, add \$290

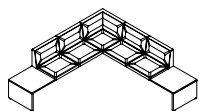

		Seat												
		COM	COL	Gr.1	Gr.2	Gr.3	Gr.4	Gr.5	Gr.6	Gr.7	Gr.8	Gr.9	Gr.10	Gr. 11
M	Metal, End Tables	8680	9202	8970	9099	9212	9340	9438	9518	9599	9695	9792	9889	10002
U	Upholstered, End Tables	8967	9506	9257	9386	9498	9627	9724	9804	9886	9982	10078	10176	10288
		Leather												
		Gr.12	Gr.13	Gr.14	Gr.15	Gr.16	Gr.17	Gr.18	Gr.19	Gr.20	LB	LC	LD	
M	Metal, End Tables	10130	10292	10453	10614	10775	10935	11097	11258	11419	10950	11824	12115	
U	Upholstered, End Tables	10417	10578	10739	10901	11062	11222	11383	11544	11706	11254	12128	12419	
		Back												
		COM	COL	Gr.1	Gr.2	Gr.3	Gr.4	Gr.5	Gr.6	Gr.7	Gr.8	Gr.9	Gr.10	Gr. 11
M	Metal, End Tables	0	116	348	502	638	792	908	1006	1102	1218	1334	1450	1586
U	Upholstered, End Tables	0	116	348	502	638	792	908	1006	1102	1218	1334	1450	1586
		Leather												
		Gr.12	Gr.13	Gr.14	Gr.15	Gr.16	Gr.17	Gr.18	Gr.19	Gr.20	LB	LC	LD	
M	Metal, End Tables	1740	1934	2126	2320	2514	2706	2900	3094	3286	2204	3248	3596	
U	Upholstered, End Tables	1740	1934	2126	2320	2514	2706	2900	3094	3286	2204	3248	3596	
		Leg												
		COM	COL	Gr.1	Gr.2	Gr.3	Gr.4	Gr.5	Gr.6	Gr.7	Gr.8	Gr.9	Gr.10	Gr. 11
M	Metal, End Tables	n/a	n/a	n/a	n/a	n/a	n/a	n/a	n/a	n/a	n/a	n/a	n/a	n/a
U	Upholstered, End Tables	0	116	174	252	319	397	455	502	551	609	667	725	792
		Leather												
		Gr.12	Gr.13	Gr.14	Gr.15	Gr.16	Gr.17	Gr.18	Gr.19	Gr.20	LB	LC	LD	
M	Metal, End Tables	n/a	n/a	n/a	n/a	n/a	n/a	n/a	n/a	n/a	n/a	n/a	n/a	
U	Upholstered, End Tables	870	966	1064	1160	1256	1354	1546	1546	1644	1168	1694	1869	
		Table												
		Studio												
		Foundation	Laminate	Studio										
				Veneer										
M	Metal, End Tables	186		580										
U	Upholstered, End Tables	186		580										

STPT8C clique eight-seat bench with table, no back, left run-off

Product Options

Leg Style	Table Style	Seat Upholstery	Leg Finish	Table Finish
U Upholstered	C Corner Table	Fabric	Fabric	Studio Foundation
M Metal	E End Tables	Leather	Leather	Laminate
			C9 Polished Aluminum	Studio Veneer
			Fundamental Paint	
			Fashion Paint	

Note For Polished Aluminum, add \$0
 For Fundamental Paint, add \$174
 For Fashion Paint, add \$290

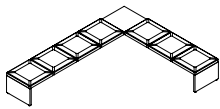

	Seat												
	COM	COL	Gr.1	Gr.2	Gr.3	Gr.4	Gr.5	Gr.6	Gr.7	Gr.8	Gr.9	Gr.10	Gr.11
M Metal, Corner Table	6972	7390	7378	7559	7716	7896	8032	8144	8257	8393	8528	8663	8821
M Metal, End Tables	6972	7390	7320	7474	7610	7764	7880	7977	8074	8190	8306	8422	8557
U Upholstered, Corner Table	7357	7799	7763	7944	8101	8281	8417	8529	8642	8778	8913	9048	9206
U Upholstered, End Tables	7357	7799	7705	7859	7995	8149	8265	8362	8459	8575	8691	8807	8942

											Leather		
	Gr.12	Gr.13	Gr.14	Gr.15	Gr.16	Gr.17	Gr.18	Gr.19	Gr.20	LB	LC	LD	
M Metal, Corner Table	9002	9227	9453	9678	9904	10129	10355	10580	10807	9834	11056	11463	
M Metal, End Tables	8712	8905	9098	9292	9485	9678	9872	10065	10258	9478	10522	10870	
U Upholstered, Corner Table	9387	9612	9838	10063	10289	10514	10740	10965	11192	10243	11464	11871	
U Upholstered, End Tables	9097	9290	9483	9677	9870	10063	10257	10450	10643	9887	10931	11279	

	Leg												
	COM	COL	Gr.1	Gr.2	Gr.3	Gr.4	Gr.5	Gr.6	Gr.7	Gr.8	Gr.9	Gr.10	Gr.11
M Metal, Corner Table	n/a	n/a	n/a	n/a	n/a	n/a	n/a	n/a	n/a	n/a	n/a	n/a	n/a
M Metal, End Tables	n/a	n/a	n/a	n/a	n/a	n/a	n/a	n/a	n/a	n/a	n/a	n/a	n/a
U Upholstered, Corner Table	0	116	174	252	319	397	455	502	551	609	667	725	792
U Upholstered, End Tables	0	116	174	252	319	397	455	502	551	609	667	725	792

											Leather		
	Gr.12	Gr.13	Gr.14	Gr.15	Gr.16	Gr.17	Gr.18	Gr.19	Gr.20	LB	LC	LD	
M Metal, Corner Table	n/a	n/a	n/a	n/a	n/a	n/a	n/a	n/a	n/a	n/a	n/a	n/a	
M Metal, End Tables	n/a	n/a	n/a	n/a	n/a	n/a	n/a	n/a	n/a	n/a	n/a	n/a	
U Upholstered, Corner Table	870	966	1064	1160	1256	1354	1546	1546	1644	1168	1694	1869	
U Upholstered, End Tables	870	966	1064	1160	1256	1354	1546	1546	1644	1168	1694	1869	

	Table	
	Studio Foundation Laminate	Studio Veneer
M Metal, Corner Table	93	290
M Metal, End Tables	186	580
U Upholstered, Corner Table	93	290
U Upholstered, End Tables	186	580

STPT8D clique eight-seat bench with table, full back, left run-off

Product Options

Leg Style	Table Style	Seat Upholstery	Back Upholstery	Leg Finish	Table Finish
U Upholstered	C Corner Table	Fabric	Fabric	Fabric	Studio Foundation
M Metal		Leather	Leather	Leather C9 Polished Aluminum Fundamental Paint Fashion Paint	Laminate Studio Veneer

Note For Polished Aluminum, add \$0
 For Fundamental Paint, add \$174
 For Fashion Paint, add \$290

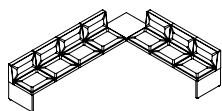

		Seat															
		COM	COL	Gr.1	Gr.2	Gr.3	Gr.4	Gr.5	Gr.6	Gr.7	Gr.8	Gr.9	Gr.10	Gr.11			
M	Metal, Corner Table	10281	10899	10687	10868	11026	11206	11341	11454	11566	11702	11838	11972	12130			
U	Upholstered, Corner Table	10667	11309	11073	11254	11412	11592	11728	11840	11953	12088	12224	12359	12516			
		Gr.12	Gr.13	Gr.14	Gr.15	Gr.16	Gr.17	Gr.18	Gr.19	Gr.20	Leather						
											LB	LC	LD				
M	Metal, Corner Table	12311	12536	12762	12987	13214	13439	13665	13890	14116		13343	14565	14972			
U	Upholstered, Corner Table	12697	12922	13149	13374	13600	13825	14051	14276	14502		13753	14974	15382			
		Back															
		COM	COL	Gr.1	Gr.2	Gr.3	Gr.4	Gr.5	Gr.6	Gr.7	Gr.8	Gr.9	Gr.10	Gr.11			
M	Metal, Corner Table	0	116	406	587	745	925	1060	1173	1285	1421	1557	1691	1849			
U	Upholstered, Corner Table	0	116	406	587	745	925	1060	1173	1285	1421	1557	1691	1849			
		Gr.12	Gr.13	Gr.14	Gr.15	Gr.16	Gr.17	Gr.18	Gr.19	Gr.20	Leather						
											LB	LC	LD				
M	Metal, Corner Table	2030	2255	2481	2706	2932	3158	3384	3609	3835		2560	3782	4189			
U	Upholstered, Corner Table	2030	2255	2481	2706	2932	3158	3384	3609	3835		2560	3782	4189			
		Leg															
		COM	COL	Gr.1	Gr.2	Gr.3	Gr.4	Gr.5	Gr.6	Gr.7	Gr.8	Gr.9	Gr.10	Gr.11			
M	Metal, Corner Table	n/a	n/a	n/a	n/a	n/a	n/a	n/a	n/a	n/a	n/a	n/a	n/a	n/a			
U	Upholstered, Corner Table	0	116	174	252	319	397	455	502	551	609	667	725	792			
		Gr.12	Gr.13	Gr.14	Gr.15	Gr.16	Gr.17	Gr.18	Gr.19	Gr.20	Leather						
											LB	LC	LD				
M	Metal, Corner Table	n/a	n/a	n/a	n/a	n/a	n/a	n/a	n/a	n/a		n/a	n/a	n/a			
U	Upholstered, Corner Table	870	966	1064	1160	1256	1354	1546	1546	1644		1168	1694	1869			
		Table															
		Studio															
		Foundation	Laminate	Studio													
				Veneer													
M	Metal, Corner Table	0		58													
U	Upholstered, Corner Table	0		58													

STPT8F clique eight-seat bench with table, back with open ends, left run-off

Product Options

Leg Style	Table Style	Seat Upholstery	Back Upholstery	Leg Finish	Table Finish
U Upholstered	E End Tables	Fabric	Fabric	Fabric	Studio Foundation
M Metal		Leather	Leather	Leather C9 Polished Aluminum Fundamental Paint Fashion Paint	Laminate Studio Veneer

Note For Polished Aluminum, add \$0
 For Fundamental Paint, add \$174
 For Fashion Paint, add \$290

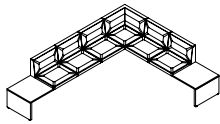

		Seat												
		COM	COL	Gr.1	Gr.2	Gr.3	Gr.4	Gr.5	Gr.6	Gr.7	Gr.8	Gr.9	Gr.10	Gr.11
M	Metal, End Tables	9452	10020	9800	9954	10090	10244	10360	10457	10554	10670	10786	10902	11037
U	Upholstered, End Tables	9738	10324	10086	10240	10376	10530	10646	10744	10840	10956	11072	11188	11324
												Leather		
		Gr.12	Gr.13	Gr.14	Gr.15	Gr.16	Gr.17	Gr.18	Gr.19	Gr.20	LB	LC	LD	
M	Metal, End Tables	11192	11385	11578	11772	11965	12158	12352	12545	12738	12108	13152	13500	
U	Upholstered, End Tables	11478	11672	11864	12058	12252	12444	12638	12832	13024	12412	13456	13804	
		Back												
		COM	COL	Gr.1	Gr.2	Gr.3	Gr.4	Gr.5	Gr.6	Gr.7	Gr.8	Gr.9	Gr.10	Gr.11
M	Metal, End Tables	0	116	406	587	745	925	1060	1173	1285	1421	1557	1691	1849
U	Upholstered, End Tables	0	116	406	587	745	925	1060	1173	1285	1421	1557	1691	1849
												Leather		
		Gr.12	Gr.13	Gr.14	Gr.15	Gr.16	Gr.17	Gr.18	Gr.19	Gr.20	LB	LC	LD	
M	Metal, End Tables	2030	2255	2481	2706	2932	3158	3384	3609	3835	2560	3782	4189	
U	Upholstered, End Tables	2030	2255	2481	2706	2932	3158	3384	3609	3835	2560	3782	4189	
		Leg												
		COM	COL	Gr.1	Gr.2	Gr.3	Gr.4	Gr.5	Gr.6	Gr.7	Gr.8	Gr.9	Gr.10	Gr.11
M	Metal, End Tables	n/a	n/a	n/a	n/a	n/a	n/a	n/a	n/a	n/a	n/a	n/a	n/a	n/a
U	Upholstered, End Tables	0	116	174	252	319	397	455	502	551	609	667	725	792
												Leather		
		Gr.12	Gr.13	Gr.14	Gr.15	Gr.16	Gr.17	Gr.18	Gr.19	Gr.20	LB	LC	LD	
M	Metal, End Tables	n/a	n/a	n/a	n/a	n/a	n/a	n/a	n/a	n/a	n/a	n/a	n/a	
U	Upholstered, End Tables	870	966	1064	1160	1256	1354	1546	1546	1644	1168	1694	1869	
		Table												
		Studio												
		Foundation	Studio											
		Laminate	Veneer											
M	Metal, End Tables	186	580											
U	Upholstered, End Tables	186	580											

STPT8G clique eight-seat bench with table, no back, right run-off

Product Options

Leg Style	Table Style	Seat Upholstery	Leg Finish	Table Finish
U Upholstered	C Corner Table	Fabric	Fabric	Studio Foundation
M Metal	E End Tables	Leather	Leather C9 Polished Aluminum Fundamental Paint Fashion Paint	Laminate Studio Veneer

Note For Polished Aluminum, add \$0
 For Fundamental Paint, add \$174
 For Fashion Paint, add \$290

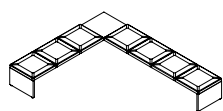

		Seat												
		COM	COL	Gr.1	Gr.2	Gr.3	Gr.4	Gr.5	Gr.6	Gr.7	Gr.8	Gr.9	Gr.10	Gr. 11
M	Metal, Corner Table	6972	7390	7378	7559	7716	7896	8032	8144	8257	8393	8528	8663	8821
M	Metal, End Tables	6972	7390	7320	7474	7610	7764	7880	7977	8074	8190	8306	8422	8557
U	Upholstered, Corner Table	7357	7799	7763	7944	8101	8281	8417	8529	8642	8778	8913	9048	9206
U	Upholstered, End Tables	7357	7799	7705	7859	7995	8149	8265	8362	8459	8575	8691	8807	8942

												Leather		
		Gr.12	Gr.13	Gr.14	Gr.15	Gr.16	Gr.17	Gr.18	Gr.19	Gr.20	LB	LC	LD	
M	Metal, Corner Table	9002	9227	9453	9678	9904	10129	10355	10580	10807	9834	11056	11463	
M	Metal, End Tables	8712	8905	9098	9292	9485	9678	9872	10065	10258	9478	10522	10870	
U	Upholstered, Corner Table	9387	9612	9838	10063	10289	10514	10740	10965	11192	10243	11464	11871	
U	Upholstered, End Tables	9097	9290	9483	9677	9870	10063	10257	10450	10643	9887	10931	11279	

		Leg												
		COM	COL	Gr.1	Gr.2	Gr.3	Gr.4	Gr.5	Gr.6	Gr.7	Gr.8	Gr.9	Gr.10	Gr. 11
M	Metal, Corner Table	n/a	n/a	n/a	n/a	n/a	n/a	n/a	n/a	n/a	n/a	n/a	n/a	n/a
M	Metal, End Tables	n/a	n/a	n/a	n/a	n/a	n/a	n/a	n/a	n/a	n/a	n/a	n/a	n/a
U	Upholstered, Corner Table	0	116	174	252	319	397	455	502	551	609	667	725	792
U	Upholstered, End Tables	0	116	174	252	319	397	455	502	551	609	667	725	792

												Leather		
		Gr.12	Gr.13	Gr.14	Gr.15	Gr.16	Gr.17	Gr.18	Gr.19	Gr.20	LB	LC	LD	
M	Metal, Corner Table	n/a	n/a	n/a	n/a	n/a	n/a	n/a	n/a	n/a	n/a	n/a	n/a	
M	Metal, End Tables	n/a	n/a	n/a	n/a	n/a	n/a	n/a	n/a	n/a	n/a	n/a	n/a	
U	Upholstered, Corner Table	870	966	1064	1160	1256	1354	1546	1546	1644	1168	1694	1869	
U	Upholstered, End Tables	870	966	1064	1160	1256	1354	1546	1546	1644	1168	1694	1869	

		Table	
		Studio	
		Foundation Laminate	Studio Veneer
M	Metal, Corner Table	93	290
M	Metal, End Tables	186	580
U	Upholstered, Corner Table	93	290
U	Upholstered, End Tables	186	580

STPT8H clique eight-seat bench with table, full back, right run-off

Product Options

Leg Style	Table Style	Seat Upholstery	Back Upholstery	Leg Finish	Table Finish
U Upholstered	C Corner Table	Fabric	Fabric	Fabric	Studio Foundation
M Metal		Leather	Leather	Leather C9 Polished Aluminum Fundamental Paint Fashion Paint	Laminate Studio Veneer

Note For Polished Aluminum, add \$0
 For Fundamental Paint, add \$174
 For Fashion Paint, add \$290

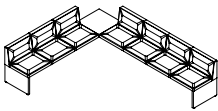

Seat

	COM	COL	Gr.1	Gr.2	Gr.3	Gr.4	Gr.5	Gr.6	Gr.7	Gr.8	Gr.9	Gr.10	Gr. 11	
M Metal, Corner Table	10281	10899	10687	10868	11026	11206	11341	11454	11566	11702	11838	11972	12130	
U Upholstered, Corner Table	10667	11309	11073	11254	11412	11592	11728	11840	11953	12088	12224	12359	12516	
											Leather			
												LB	LC	LD
M Metal, Corner Table	12311	12536	12762	12987	13214	13439	13665	13890	14116		13343	14565	14972	
U Upholstered, Corner Table	12697	12922	13149	13374	13600	13825	14051	14276	14502		13753	14974	15382	

Back

	COM	COL	Gr.1	Gr.2	Gr.3	Gr.4	Gr.5	Gr.6	Gr.7	Gr.8	Gr.9	Gr.10	Gr. 11	
M Metal, Corner Table	0	116	406	587	745	925	1060	1173	1285	1421	1557	1691	1849	
U Upholstered, Corner Table	0	116	406	587	745	925	1060	1173	1285	1421	1557	1691	1849	
												Leather		
												LB	LC	LD
M Metal, Corner Table	2030	2255	2481	2706	2932	3158	3384	3609	3835		2560	3782	4189	
U Upholstered, Corner Table	2030	2255	2481	2706	2932	3158	3384	3609	3835		2560	3782	4189	

Leg

	COM	COL	Gr.1	Gr.2	Gr.3	Gr.4	Gr.5	Gr.6	Gr.7	Gr.8	Gr.9	Gr.10	Gr. 11	
M Metal, Corner Table	n/a	n/a	n/a	n/a	n/a	n/a	n/a	n/a	n/a	n/a	n/a	n/a	n/a	
U Upholstered, Corner Table	0	116	174	252	319	397	455	502	551	609	667	725	792	
												Leather		
												LB	LC	LD
M Metal, Corner Table	n/a	n/a	n/a	n/a	n/a	n/a	n/a	n/a	n/a	n/a	n/a	n/a	n/a	
U Upholstered, Corner Table	870	966	1064	1160	1256	1354	1546	1546	1644		1168	1694	1869	

Table

	Studio Foundation Laminate	Studio Veneer
M Metal, Corner Table	0	58
U Upholstered, Corner Table	0	58

STPT8K clique eight-seat bench with table, back with open ends, right run-off

Product Options

Leg Style	Table Style	Seat Upholstery	Back Upholstery	Leg Finish	Table Finish
U Upholstered	E End Tables	Fabric	Fabric	Fabric	Studio Foundation
M Metal		Leather	Leather	Leather C9 Polished Aluminum Fundamental Paint Fashion Paint	Laminate Studio Veneer

Note For Polished Aluminum, add \$0
 For Fundamental Paint, add \$174
 For Fashion Paint, add \$290

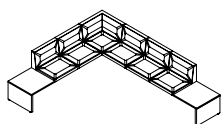

		Seat																				
		COM	COL	Gr.1	Gr.2	Gr.3	Gr.4	Gr.5	Gr.6	Gr.7	Gr.8	Gr.9	Gr.10	Gr. 11								
M	Metal, End Tables	9452	10020	9800	9954	10090	10244	10360	10457	10554	10670	10786	10902	11037								
U	Upholstered, End Tables	9738	10324	10086	10240	10376	10530	10646	10744	10840	10956	11072	11188	11324								
													Leather									
		Gr.12	Gr.13	Gr.14	Gr.15	Gr.16	Gr.17	Gr.18	Gr.19	Gr.20	Gr.12	Gr.13	Gr.14	Gr.15	Gr.16	Gr.17	Gr.18	Gr.19	Gr.20	LB	LC	LD
M	Metal, End Tables	11192	11385	11578	11772	11965	12158	12352	12545	12738	12108	13152	13500									
U	Upholstered, End Tables	11478	11672	11864	12058	12252	12444	12638	12832	13024	12412	13456	13804									
		Back																				
		COM	COL	Gr.1	Gr.2	Gr.3	Gr.4	Gr.5	Gr.6	Gr.7	Gr.8	Gr.9	Gr.10	Gr. 11								
M	Metal, End Tables	0	116	406	587	745	925	1060	1173	1285	1421	1557	1691	1849								
U	Upholstered, End Tables	0	116	406	587	745	925	1060	1173	1285	1421	1557	1691	1849								
													Leather									
		Gr.12	Gr.13	Gr.14	Gr.15	Gr.16	Gr.17	Gr.18	Gr.19	Gr.20	Gr.12	Gr.13	Gr.14	Gr.15	Gr.16	Gr.17	Gr.18	Gr.19	Gr.20	LB	LC	LD
M	Metal, End Tables	2030	2255	2481	2706	2932	3158	3384	3609	3835	2560	3782	4189									
U	Upholstered, End Tables	2030	2255	2481	2706	2932	3158	3384	3609	3835	2560	3782	4189									
		Leg																				
		COM	COL	Gr.1	Gr.2	Gr.3	Gr.4	Gr.5	Gr.6	Gr.7	Gr.8	Gr.9	Gr.10	Gr. 11								
M	Metal, End Tables	n/a	n/a	n/a	n/a	n/a	n/a	n/a	n/a	n/a	n/a	n/a	n/a	n/a								
U	Upholstered, End Tables	0	116	174	252	319	397	455	502	551	609	667	725	792								
													Leather									
		Gr.12	Gr.13	Gr.14	Gr.15	Gr.16	Gr.17	Gr.18	Gr.19	Gr.20	Gr.12	Gr.13	Gr.14	Gr.15	Gr.16	Gr.17	Gr.18	Gr.19	Gr.20	LB	LC	LD
M	Metal, End Tables	n/a	n/a	n/a	n/a	n/a	n/a	n/a	n/a	n/a	n/a	n/a	n/a	n/a	n/a	n/a	n/a	n/a	n/a	n/a	n/a	n/a
U	Upholstered, End Tables	870	966	1064	1160	1256	1354	1546	1546	1644	1168	1694	1869									
		Table																				
		Studio																				
		Foundation	Laminate	Studio	Veneer																	
M	Metal, End Tables	186	580																			
U	Upholstered, End Tables	186	580																			

STYC clique single power accessory

Product Options

Style	Wire Option	Finish
A 1 Simplex, 2 USB-A	P North American Plug H Hardwire	52 Ebony Coordinate

Note 10' cord length



Price

North American Plug	Hardwire
493	529

STYB clique dual power accessory

Product Options

Style	Wire Option	Finish
E Two Units - both 1 Simplex, 2 USB-A	P North American Plug	52 Ebony Coordinate

Note 10' cord length



Price

1436

STYU clique usb hub power accessory

Product Options

Style	Wire Option	Finish
1 1 USB-A Hub	P North American Plug	68 Anthracite
2 2 USB-A Hubs		
4 4 USB-A Hubs		

Note 10' cord length



	Price
1 1 USB-A Hub	249
2 2 USB-A Hubs	500
4 4 USB-A Hubs	726

cover

features

Designed by Claesson Koivisto Rune, the Cover lounge collection is inspired by classically tailored garments worn in a layered style. The collection plays in tune with any room, office or even home. With a high degree of upholstered comfort, Cover creates a light-scale environment perfect for quick meetings and conferencing or a private nook for individual reflection. The four-star swivel and the four-leg base can be finished in polished aluminum or embellished with color in any of Studio TK's Fundamental or Fashion powder coats.



dimensions

- Designed and tested for users up to 300 lbs
- Meets ANSI/BIFMA requirements

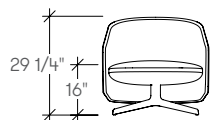
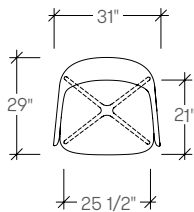

Lounge Chair
(STRA)

planning

A variety of configurations can be achieved with Cover, allowing for various levels of privacy. The following typical demonstrate the versatility that can be achieved.

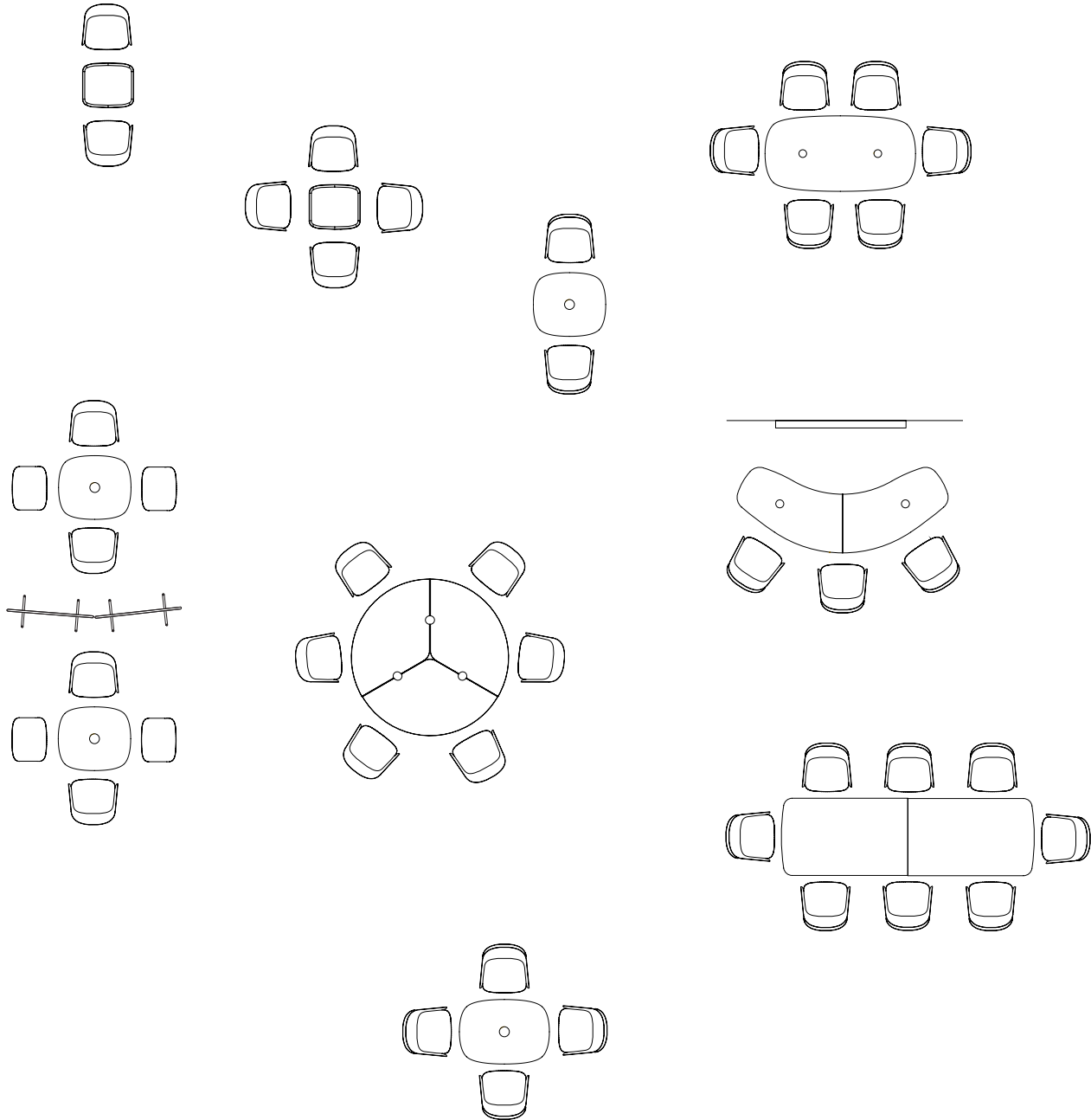

specifying cover finishes

The modularity of Cover permits a wide range of fabric combinations that allows for an expressive use of color, texture and material. The seat back upholstery and privacy back can all be finished in different fabrics if desired.

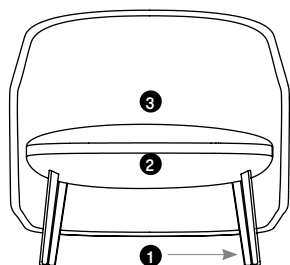

- 1 Base Style and Frame Finish**
Select the base style (swivel or four leg) and select finish (Polished Aluminum, Fundamental Paint or Fashion Paint)
- 2 Seat Upholstery**
Select the seat upholstery
- 3 Back Upholstery**
Select the back upholstery

specification example

STRAA - Cover Lounge Chair, Swivel	
2 Seat fabric Gr.5	3356
3 Back fabric Gr.5	204
Total:	\$3560

STRAA - Cover Lounge Chair, Swivel	
2 Seat fabric Gr.5	3356
3 Back fabric Gr.3	144
Add Fundamental Paint	64
Total:	\$3564

STRAA - Cover Lounge Chair, Swivel	
2 Seat fabric Gr.5	3356
3 Back fabric Gr.9	300
Add Fashion Paint	87
Total:	\$3743

weights

Cover Lounge Chair	65 - 70 lbs
--------------------	-------------

COM/COL material requirement

Yardage is based on a non-patterned fabric. Additional yardage may be required for pattern repeats and the matching required. Leather yield may be affected by the quality of the COL. However, variance in the size of the hides will not affect the yield.



SINGLE UPHOLSTERY		COM [yards]	COL [sq. ft.]
Cover Lounge Chair (Swivel)	Seat	1 1/2	27
	Back	3 3/4	67 1/2
Cover Lounge Chair (Four Leg)	Seat	1 1/2	27
	Back	3 3/4	67 1/2

STRA cover lounge chair

Product Options

Style	Seat Upholstery Finish	Back Upholstery Finish	Frame Finish
A Lounge Chair - Swivel	Fabric	Fabric	C9 Polished Aluminum
B Lounge Chair - Four Leg	Leather	Leather	Fundamental Paint Fashion Paint

Note Swivel version includes auto return to center swivel mechanism
 For Fundamental Paint, add \$64
 For Fashion Paint, add \$87

		Seat												
		COM	COL	Gr.1	Gr.2	Gr.3	Gr.4	Gr.5	Gr.6	Gr.7	Gr.8	Gr.9	Gr.10	Gr.11
	A Lounge Chair - Swivel	2720	2993	2964	3072	3167	3275	3356	3424	3492	3573	3654	3735	3830
	B Lounge Chair - Four Leg	2567	2823	2811	2919	3014	3122	3203	3271	3338	3420	3501	3582	3677
												Leather		
		Gr.12	Gr.13	Gr.14	Gr.15	Gr.16	Gr.17	Gr.18	Gr.19	Gr.20	LB	LC	LD	
	A Lounge Chair - Swivel	3938	4074	4208	4344	4480	4614	4750	4886	5020	4454	5185	5429	
	B Lounge Chair - Four Leg	3785	3921	4055	4191	4327	4461	4597	4733	4867	4285	5016	5259	
		Back												
		COM	COL	Gr.1	Gr.2	Gr.3	Gr.4	Gr.5	Gr.6	Gr.7	Gr.8	Gr.9	Gr.10	Gr.11
	A Lounge Chair - Swivel	116	116	79	114	144	179	204	226	248	274	300	326	357
	B Lounge Chair - Four Leg	116	116	79	114	144	179	204	226	248	274	300	326	357
												Leather		
		Gr.12	Gr.13	Gr.14	Gr.15	Gr.16	Gr.17	Gr.18	Gr.19	Gr.20	LC	LD		
	A Lounge Chair - Swivel	392	435	479	522	566	609	653	696	740	705	783		
	B Lounge Chair - Four Leg	392	435	479	522	566	609	653	696	740	705	783		

delta

features

In partnership with Vondom – a leading Spanish provider of furniture for modern indoor and outdoor commercial spaces – Studio TK is offering Delta seating in North America.

The Delta collection by Jorge Pensi blends equally well with exterior or interior contemporary spaces. The design intent behind the Delta chair was to create a timeless product that constantly seeks to strike a balance between realism and surrealism – matter and antimatter, abstraction and emotion. The goal was to maximize emotions while minimizing resources, questioning the common logic of something new. Delta seating is made of injected polypropylene with fiberglass. Chairs are stackable and available in several colors.



dimensions

- Designed and tested for users up to 300 lbs
- Meets ANSI/BIFMA requirements

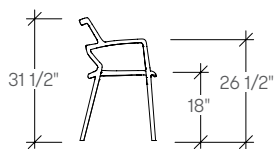
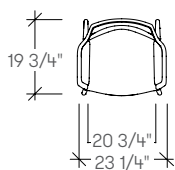

Delta Chair
(VMDL)

VMDL delta chair

Product Options

Style

A Arm Chair

Vondom Plastic

C1 White

C2 Ecu

C3 Black

Note Chairs stack six units high
Weight of chair is 10lbs



A Arm Chair

Price
307

dual

features

Dual lounge is a dynamic seating collection designed to celebrate expression and elevate the conversation. The duality of materials offers a seat ripe for expression. Upholster in a single color, or two, or split the difference with a partially opaque knit base available in 11 finishes. A posture fit for every occasion, a low back chair for a relaxed or casual collaboration. A high back chair for when you need time to unwind and recharge. The lounge design introduces a residential aesthetic to bring a welcoming sensibility to a range of spaces – so that work doesn't feel like work.

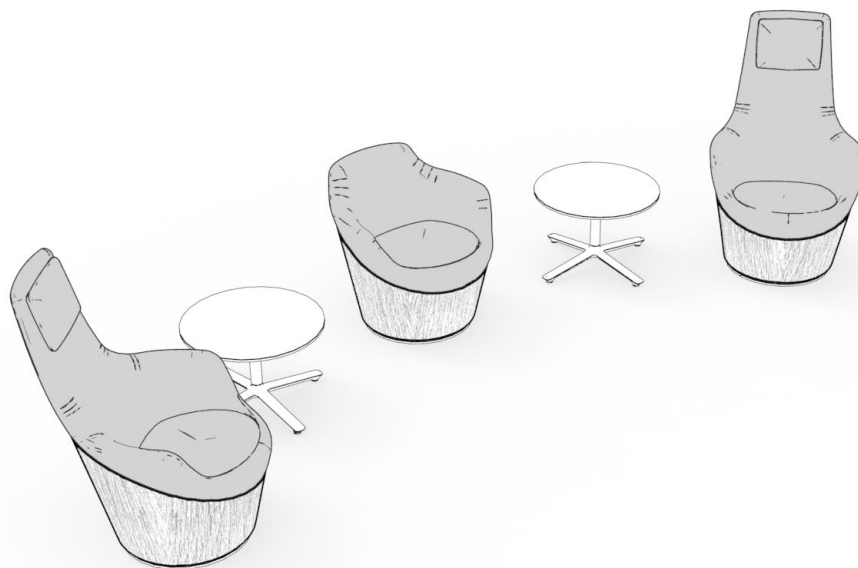

dimensions

- Designed and tested for users up to 300 lbs
- Meets ANSI/BIFMA requirements

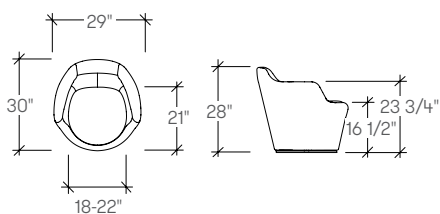

Dual Low Back Lounge
(STDA) / (STDB)

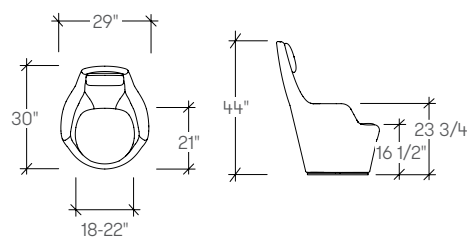

Dual High Back Lounge
(STDC) / (STDD)

dual

planning

A variety of configurations can be achieved with Dual Lounge, allowing for various configurations. The following typical demonstrate the versatility that can be achieved.

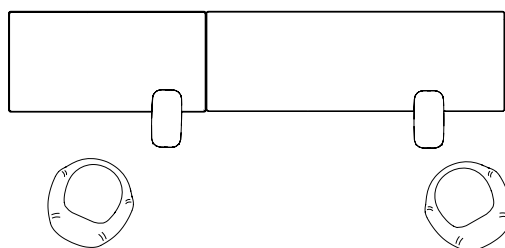
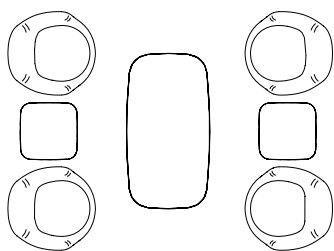
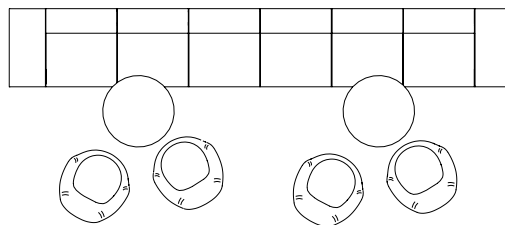
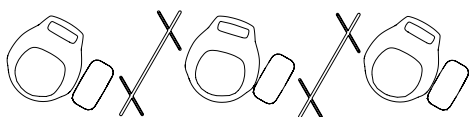
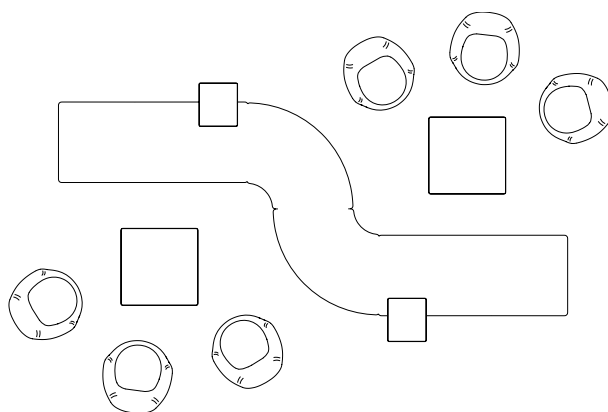
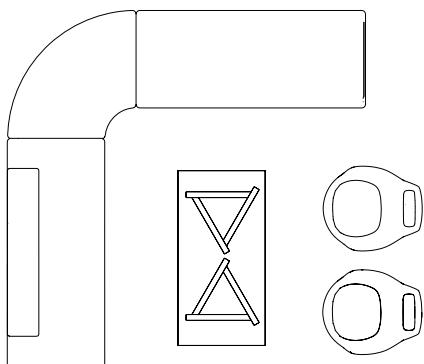
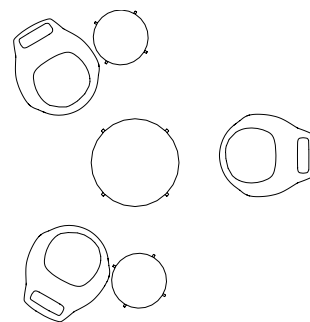
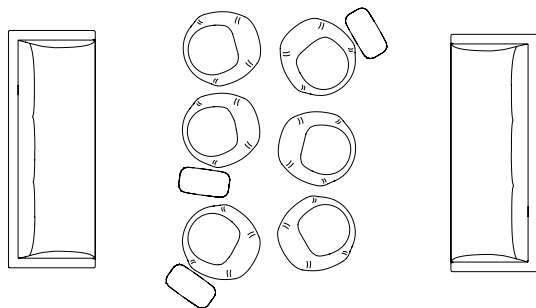

specifying dual finishes

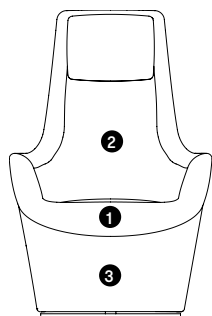

The modularity of Dual permits a wide range of fabric combinations that allows for an expressive use of color, texture and material. The opaque knit base allows for light to pass through and contrasting upholstery allows for personalization.

- 1 Seat Upholstery**
Select the seat upholstery
- 2 Back Upholstery**
Select the back upholstery
- 3 Select Base Finish**
Select knit finish or base upholstery

specification example

STDA Dual Low Back Lounge Chair, Knit Base	
1 Seat fabric Gr.5	3221
2 Back fabric Gr.5	333
3 Knit Finish	0
Total:	\$3554

STDC Dual High Back Lounge Chair, Knit Base	
1 Seat fabric Gr.5	3746
2 Back fabric Gr.3	276
3 Knit Finish	0
Total:	\$4022

STDB Dual Low Back Lounge Chair, Upholstered Base	
1 Seat fabric Gr.5	3746
2 Back fabric Gr.5	333
3 Base Upholstery Gr.3	212
Total:	\$4291

weights

Dual, Low Back Lounge, Knit Base	75 - 80 lbs
Dual, Low Back Lounge, Upholstered Base	75 - 80 lbs
Dual, High Back Lounge, Knit Base	80 - 85 lbs
Dual, High Back Lounge, Upholstered Base	80 - 85 lbs

COM/COL material requirement

Yardage is based on a non-patterned fabric. Additional yardage may be required for pattern repeats and the matching required. Leather yield may be affected by the quality of the COL. However, variance in the size of the hides will not affect the yield.

SINGLE UPHOLSTERY		COM [yards]	COL [sq. ft.]
Dual Low Back Lounge	Seat	13/4	31 1/2
	Back	2 3/4	49 1/2
Dual High Back Lounge	Seat	13/4	31 1/2
	Back	3 1/4	58 1/2

STDA dual low back lounge, knit base

Product Options

Style	Seat Pad Upholstery Finish	Back Upholstery Finish	Knit Base Finish
L Low Back Swivel Lounge Chair	Fabric	Fabric	K413 Eggshell
	Leather	Leather	K414 Stone
			K415 Khaki
			K416 Silver
			K417 Taupe
			K418 Graphite
			K419 Goldenrod
			K420 Sunset
			K421 Cardinal
			K422 Magenta
			K423 Cobalt

Note Swivel version includes auto return to center swivel mechanism



		Seat Pad Upholstery Finish Price												
		COM	COL	Gr.1	Gr.2	Gr.3	Gr.4	Gr.5	Gr.6	Gr.7	Gr.8	Gr.9	Gr.10	Gr.11
L	Low Back	3009	3309	3090	3126	3158	3193	3221	3243	3267	3293	3320	3348	3379
												Leather		
												LB	LC	LD
L	Low Back	Gr.12	Gr.13	Gr.14	Gr.15	Gr.16	Gr.17	Gr.18	Gr.19	Gr.20				
		3415	3460	3506	3551	3596	3640	3685	3731	3776	3797	4040	4121	
		Back Upholstery Finish Price												
		COM	COL	Gr.1	Gr.2	Gr.3	Gr.4	Gr.5	Gr.6	Gr.7	Gr.8	Gr.9	Gr.10	Gr.11
L	Low Back	0	116	128	184	234	291	333	369	404	447	490	531	581
												Leather		
												LB	LC	LD
L	Low Back	Gr.12	Gr.13	Gr.14	Gr.15	Gr.16	Gr.17	Gr.18	Gr.19	Gr.20				
		638	709	780	850	921	993	1064	1134	1205	766	1148	1276	

STDB dual low back lounge, upholstered base

Product Options

Style	Seat Pad Upholstery Finish	Back Upholstery Finish	Base Upholstery Finish
L Low Back Swivel Lounge Chair	Fabric Leather	Fabric Leather	Fabric

Note Base upholstery only available in Full Wool, Heather Felt, Heather Tech, Digi Tweed, Percept and Ample from Luum Textiles
Swivel version includes auto return to center swivel mechanism



Seat Pad Upholstery Finish Price

	COM	COL	Gr.1	Gr.2	Gr.3	Gr.4	Gr.5	Gr.6	Gr.7	Gr.8	Gr.9	Gr.10	Gr.11
L Low Back	3533	3887	3615	3651	3682	3718	3746	3768	3791	3818	3844	3872	3903
											Leather		
											LB	LC	LD
L Low Back	3939	3985	4030	4075	4120	4164	4210	4255	4300		4374	4618	4699

Back Upholstery Finish Price

	COM	COL	Gr.1	Gr.2	Gr.3	Gr.4	Gr.5	Gr.6	Gr.7	Gr.8	Gr.9	Gr.10	Gr.11
L Low Back	0	116	128	184	234	291	333	369	404	447	490	531	581
											Leather		
											LB	LC	LD
L Low Back	638	709	780	850	921	993	1064	1134	1205		766	1148	1276

Base Upholstery Finish Price

	Gr.1	Gr.2	Gr.3	Gr.8	Gr.9
L Low Back	116	167	212	406	444

STDC dual high back lounge, knit base

Product Options

Style	Seat Pad Upholstery Finish	Back and Headrest Upholstery Finish	Knit Base Finish
H High Back Swivel Lounge Chair	Fabric Leather	Fabric Leather	K413 Eggshell K414 Stone K415 Khaki K416 Silver K417 Taupe K418 Graphite K419 Goldenrod K420 Sunset K421 Cardinal K422 Magenta K423 Cobalt

Note Swivel version includes auto return to center swivel mechanism



Seat Pad Upholstery Finish Price

	COM	COL	Gr.1	Gr.2	Gr.3	Gr.4	Gr.5	Gr.6	Gr.7	Gr.8	Gr.9	Gr.10	Gr.11
H High Back	3533	3887	3615	3651	3682	3718	3746	3768	3791	3818	3844	3872	3903
											Leather		
											LB	LC	LD
H High Back	3939	3985	4030	4075	4120	4164	4210	4255	4300		4374	4618	4699

Back and Headrest Upholstery Finish Price

	COM	COL	Gr.1	Gr.2	Gr.3	Gr.4	Gr.5	Gr.6	Gr.7	Gr.8	Gr.9	Gr.10	Gr.11
H High Back	0	116	151	218	276	343	393	436	478	528	578	629	687
											Leather		
											LB	LC	LD
H High Back	754	838	921	1006	1089	1173	1256	1341	1424		905	1357	1508

STDD dual high back lounge, upholstered base

Product Options

Style	Seat Pad Upholstery Finish	Back and Headrest Upholstery Finish	Base Upholstery Finish
H High Back Swivel Lounge Chair	Fabric Leather	Fabric Leather	Fabric

Note Base upholstery only available in Full Wool, Heather Felt, Heather Tech, Digi Tweed, Percept and Ample from Luum Textiles
Swivel version includes auto return to center swivel mechanism



Seat Pad Upholstery Finish Price

	COM	COL	Gr.1	Gr.2	Gr.3	Gr.4	Gr.5	Gr.6	Gr.7	Gr.8	Gr.9	Gr.10	Gr.11
H High Back	4058	4464	4139	4175	4206	4242	4270	4292	4315	4342	4369	4396	4428
											Leather		
											LB	LC	LD
H High Back	4464	4509	4554	4599	4645	4689	4734	4779	4824		4951	5194	5276

Back and Headrest Upholstery Finish Price

	COM	COL	Gr.1	Gr.2	Gr.3	Gr.4	Gr.5	Gr.6	Gr.7	Gr.8	Gr.9	Gr.10	Gr.11
H High Back	0	116	151	218	276	343	393	436	478	528	578	629	687
											Leather		
											LB	LC	LD
H High Back	754	838	921	1006	1089	1173	1256	1341	1424		905	1357	1508

Base Upholstery Finish Price

	Gr.1	Gr.2	Gr.3	Gr.8	Gr.9
H High Back	116	167	212	406	444

F500 series

features

The F500 Series, in partnership with Artifort, encourages a moment to relax or recharge during a busy workday. Designed in 1967 by Geoffrey Harcourt RDI, the F500 Series lounge was inspired after noticing his girlfriend sitting in furniture cross legged. With comfort in mind, he designed a chair wide enough for this informal position. Choose from three upholstery styles from a smooth fixed upholstery for sleek modernity to a traditional tufted for elevated formality. Add personalization with a variety of powdercoat finishes to the disk base to create your own refuge.

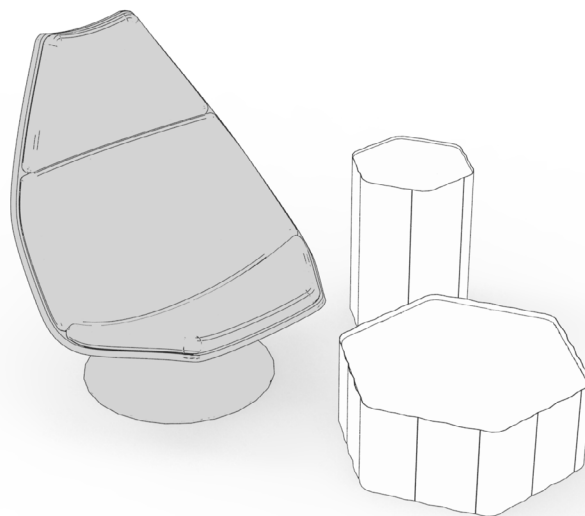

dimensions

- Designed and tested for users up to 110kg/242 lbs
- Meets standard European NEN-16139 requirements

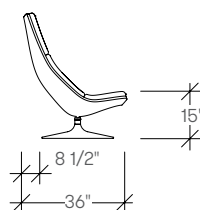
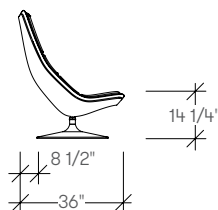
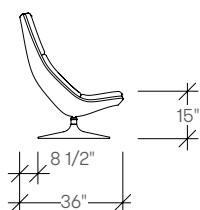
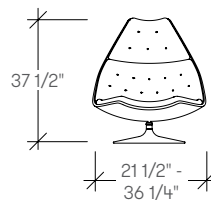
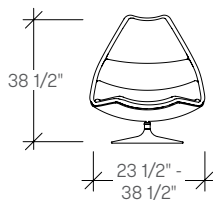
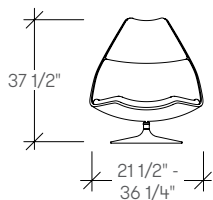
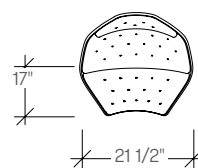
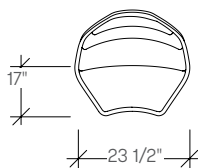
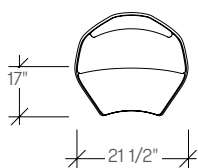

Lounge Chair, Disc Base,
Fixed Upholstery
(F510)

Lounge Chair, Disc Base,
Fixed Upholstery with Welt
(F585)

Lounge Chair, Disc Base,
Tufted Upholstery
(F588)

specifying finishes

The modularity of F500 series permits a wide range of fabric combinations that allows for an expressive use of color, texture and material.

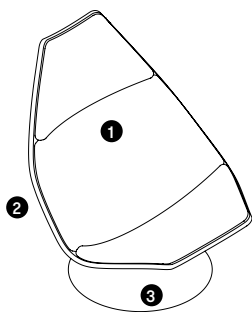

- 1 Seat Upholstery**
Select the seat upholstery
- 2 Back Upholstery**
Select the back upholstery
- 3 Select Base Finish**
Select knit finish or base upholstery

specification example

ARF510 F510 Lounge Chair, Disc Base, Fixed Upholstery	
1 Seat fabric Gr.5	5279
2 Back fabric Gr.5	273
Total:	\$5552

ARF588 F588 Lounge Chair, Disc Base, Tufted Upholstery	
1 Seat fabric Gr.5	5807
2 Back fabric Gr.3	191
Total:	\$5998

weights

F510 Lounge Chair, Disc Base, Fixed Upholstery	60 - 65 lbs
F585 Lounge Chair, Disc Base, Fixed Upholstery with Welt	64 - 69 lbs
F588 Lounge Chair, Disc Base, Tufted Upholstery	52 - 57 lbs

COM/COL material requirement

Yardage is based on a non-patterned fabric. Additional yardage may be required for pattern repeats and the matching required. Leather yield may be affected by the quality of the COL. However, variance in the size of the hides will not affect the yield.

SINGLE UPHOLSTERED		COM	COL
		[yards]	[sq. ft.]
F510 Lounge Chair	Seat	2 3/4	50
	Back	2 1/4	41
F585 Lounge Chair	Seat	4 3/4	86
F588 Lounge Chair	Seat	4 3/4	86
	Back	2 1/4	41

ARF510 F510 lounge chair, disc base, fixed upholstery

Product Options

Inner Seat Upholstery Finish	Outer Back Upholstery Finish	Base Finish
Fabric	Fabric	Fundamental Paint
Leather	Leather	Fashion Paint

Note For Fundamental Paint, add \$0
For Fashion Paint, add \$64



Seat Upholstery Finish Price

COM	COL	Gr.1	Gr.2	Gr.3	Gr.4	Gr.5	Gr.6	Gr.7	Gr.8	Gr.9	Gr.10	Gr.11
4988	5288	5116	5172	5222	5279	5321	5357	5392	5435	5478	5519	5569
										Leather		
Gr.12	Gr.13	Gr.14	Gr.15	Gr.16	Gr.17	Gr.18	Gr.19	Gr.20		LB	LC	LD
5626	5697	5768	5838	5909	5981	6052	6122	6193		6054	6437	6564

Back Upholstery Finish Price

COM	COL	Gr.1	Gr.2	Gr.3	Gr.4	Gr.5	Gr.6	Gr.7	Gr.8	Gr.9	Gr.10	Gr.11
0	116	104	151	191	238	273	302	331	365	400	435	476
										Leather		
Gr.12	Gr.13	Gr.14	Gr.15	Gr.16	Gr.17	Gr.18	Gr.19	Gr.20		LB	LC	LD
522	580	638	696	754	812	870	928	986		742	1056	1160

ARF585 F585 lounge chair, disc base, fixed upholstery with welt

Product Options

Inner Seat Upholstery Finish	Base Finish
Fabric	Fundamental Paint
	Fashion Paint

Note For Fundamental Paint, add \$0
For Fashion Paint, add \$64



Seat Upholstery Finish Price

COM	COL	Gr.1	Gr.2	Gr.3	Gr.4	Gr.5	Gr.6	Gr.7	Gr.8	Gr.9	Gr.10	Gr.11
4744	5030	4965	5062	5148	5247	5320	5381	5443	5516	5589	5663	5749
										Leather		
Gr.12	Gr.13	Gr.14	Gr.15	Gr.16	Gr.17	Gr.18	Gr.19	Gr.20		LB	LC	LD
5846	5969	6091	6214	6336	6459	6581	6704	6825		6352	7013	7234

ARF588 F588 lounge chair, disc base, tufted upholstery

Product Options

Inner Seat Upholstery Finish	Outer Back Upholstery Finish	Base Finish
Fabric	Fabric	Fundamental Paint
Leather	Leather	Fashion Paint

Note For Fundamental Paint, add \$0
For Fashion Paint, add \$64



Seat Upholstery Finish Price

COM	COL	Gr.1	Gr.2	Gr.3	Gr.4	Gr.5	Gr.6	Gr.7	Gr.8	Gr.9	Gr.10	Gr.11
5232	5546	5452	5549	5635	5734	5807	5868	5930	6003	6076	6150	6236
Gr.12	Gr.13	Gr.14	Gr.15	Gr.16	Gr.17	Gr.18	Gr.19	Gr.20	Leather			
6334	6457	6578	6701	6823	6946	7068	7191	7313	LB	LC	LD	
									6868	7530	7750	

Back Upholstery Finish Price

COM	COL	Gr.1	Gr.2	Gr.3	Gr.4	Gr.5	Gr.6	Gr.7	Gr.8	Gr.9	Gr.10	Gr.11
0	116	104	151	191	238	273	302	331	365	400	435	476
Gr.12	Gr.13	Gr.14	Gr.15	Gr.16	Gr.17	Gr.18	Gr.19	Gr.20	Leather			
522	580	638	696	754	812	870	928	986	LB	LC	LD	
									742	1056	1160	

fractals

features

Fractals Seating is boldly innovative and visually compelling and opens up new planning possibilities for contemporary, forward-thinking environments. Fractals is designed to support the worker and groups of team-based workers in open and collaborative environments and to provide a modular program that creates a new level of planning.

Fractals consists of two simple pieces: a Settee and Lounge Chair, with either low or high backs to create various degrees of surround and privacy. An optional power unit is available for added functionality and mounts below the seat.

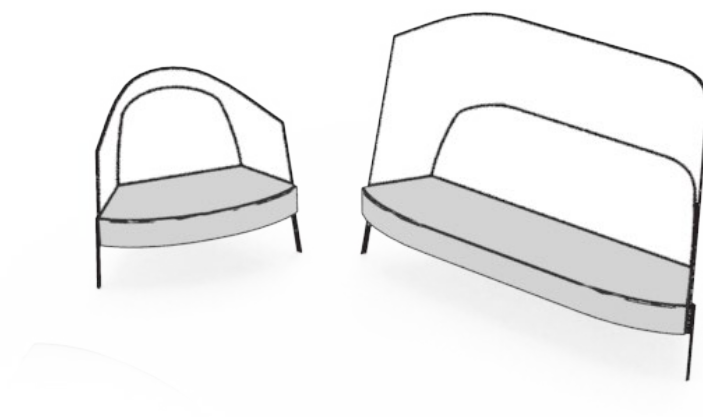

- Fractals seating elements work alone or together to create environments that focus on the needs of individuals or teams
- The Lounge Chair functions well as an alternative to touchdown desking, offering a seating surface wide enough to support the comfortable use of tablets and laptops
- The higher back on the Settee and Lounge Chair provides a clear delineation of space and creates a great sense of privacy

Fractals Seating with an interior and exterior back contrasting upholstery creates booth scenarios to allow for cool or muted colors on the exterior and vibrant colors on the interior. The contrast allows for people to be surrounded by colors for inspiration while keeping the exterior muted as to not distract other in the office.

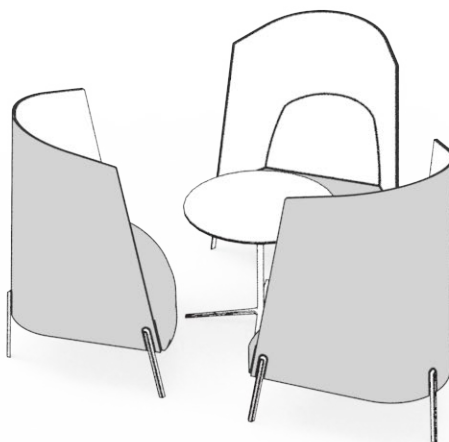

Bevy Round Coffee Table shown.

dimensions

- Designed and tested for users up to 300 lbs
- Meets ANSI/BIFMA requirements

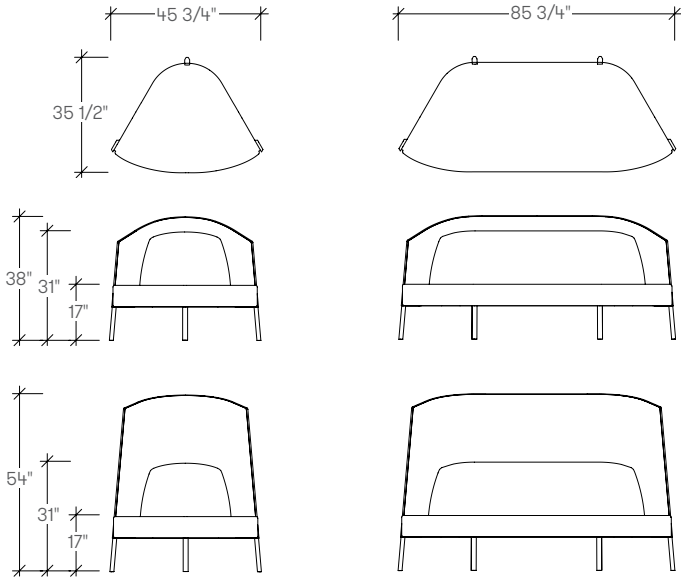

Lounge Chair Low Back & High Back* - STFS1
Settee Low Back & High Back* - STFS2

Note
* Due to the height and width of the high-back, it will not fit through a standard 30" wide door. Verify all site dimensions before ordering.

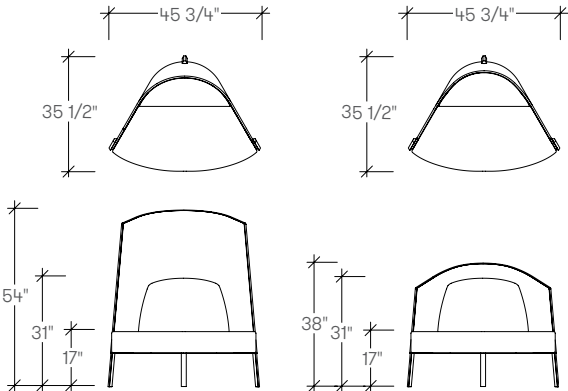

Lounge Chair - Contrasting Outer Back (STFB)

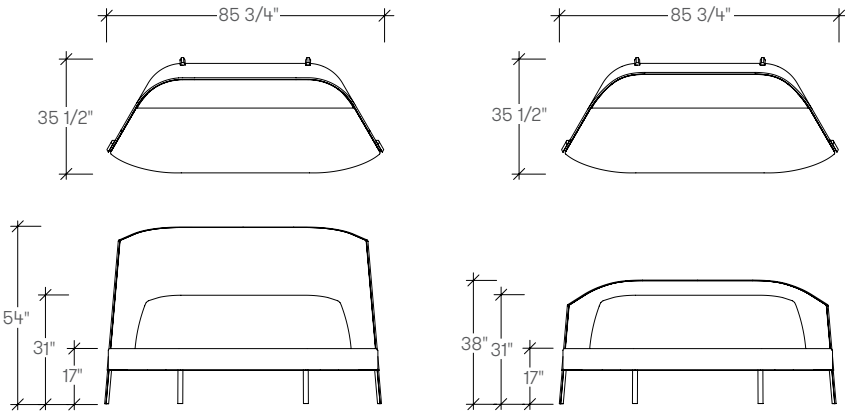

Fractals Settee - Contrasting Outer Back (STFB)

fractals

planning

A variety of configurations can be achieved with Fractals, allowing for various levels of privacy. The following typical demonstrate the versatility that can be achieved.

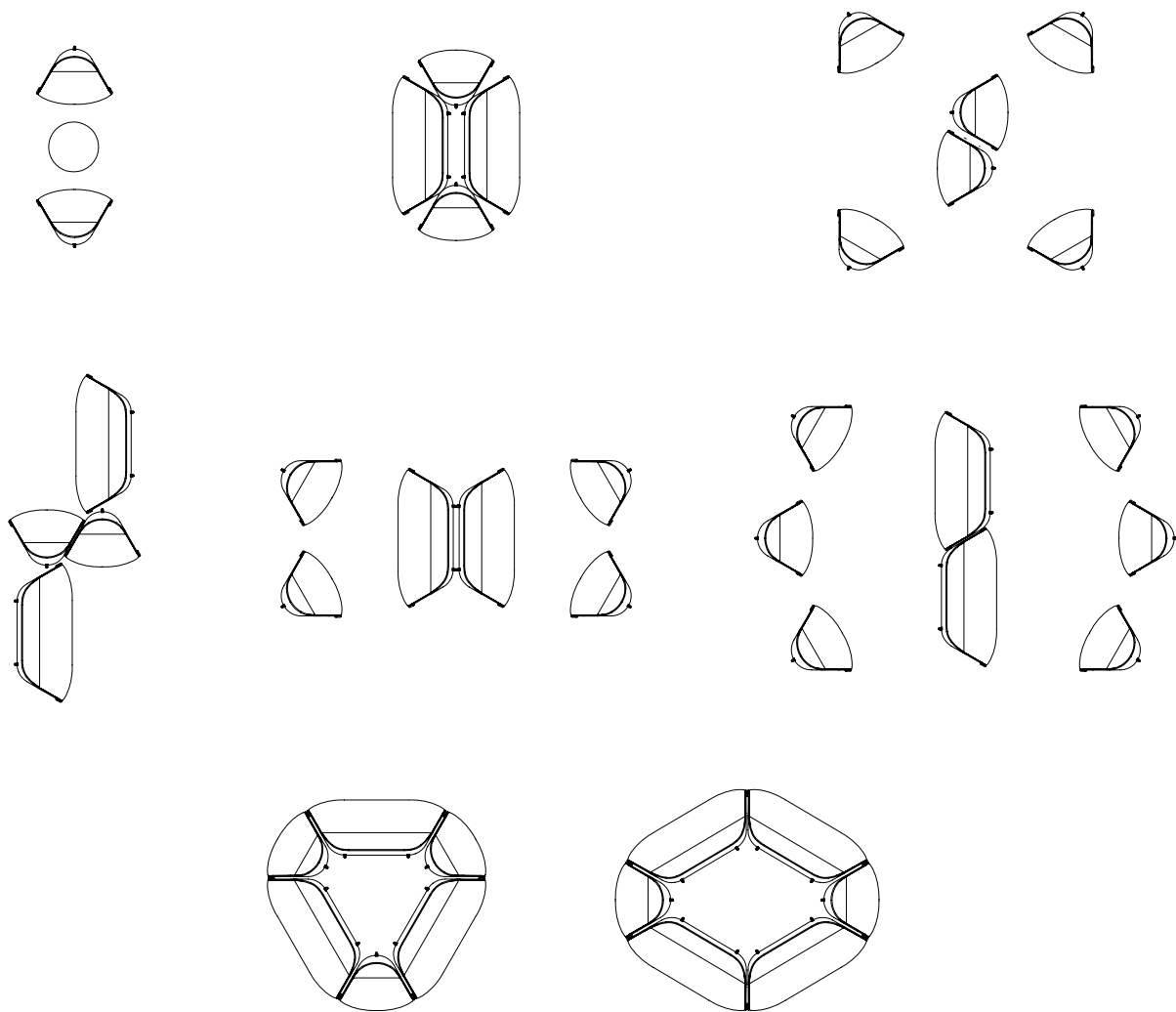

fractals contrasting back

planning

A variety of configurations can be achieved with Fractals, allowing for various levels of privacy. The following typical demonstrate the versatility that can be achieved.

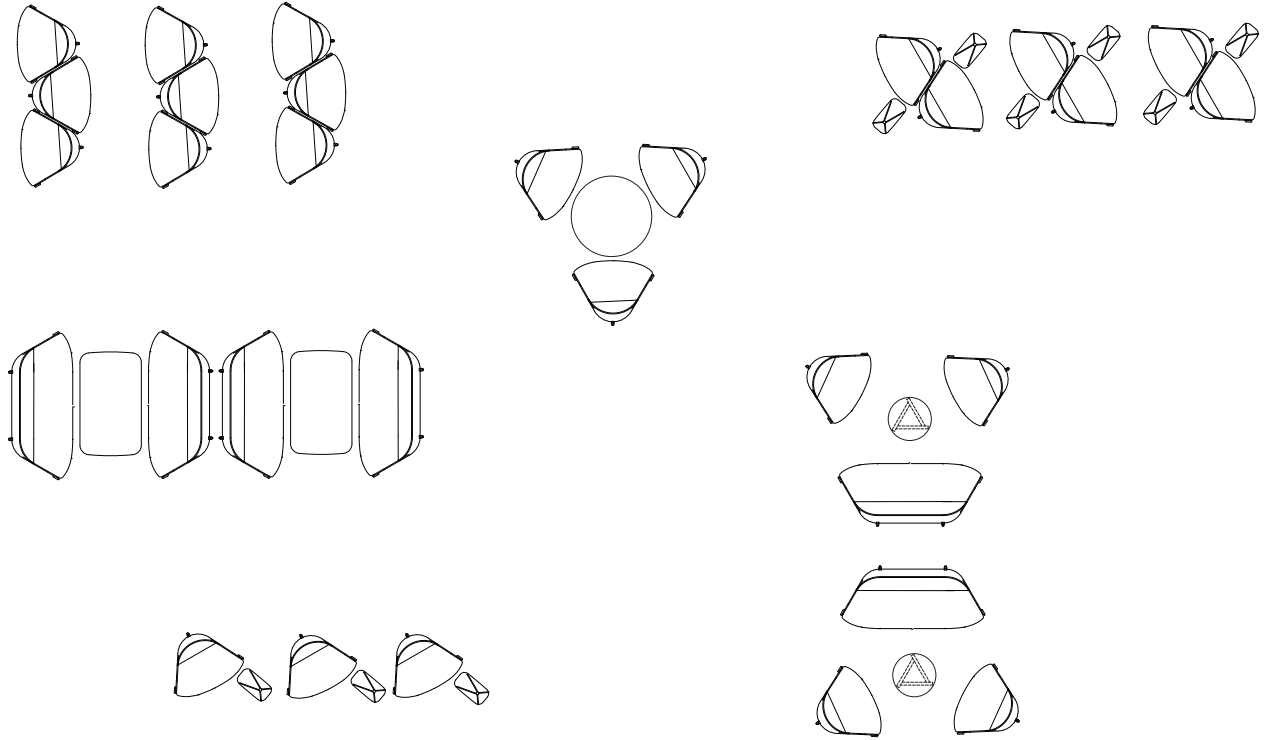

weights

Fractals, Lounge Chair High	160 - 170 lbs
Fractals, Lounge Chair Low	155 - 165 lbs
Fractals, Settee Low	245 - 255 lbs
Fractals, Settee High	250 - 260 lbs

specifying fractals finishes

The modularity of Fractals permits a wide range of fabric and wood combinations that allows for an expressive use of color, texture and material. The back, seat and bolster can all be finished in a different finish if desired.

To specify Fractals in contrasting fabrics, the seat, bolster and back must be specified individually. The seat, bolster and back prices must be added together for a complete price.

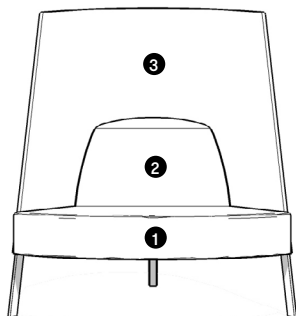

- 1 Seat**
Select the seat fabric
- 2 Bolster**
Select the bolster fabric (it can be the same fabric as the seat or a contrasting fabric)
- 3 Back**
Select the back fabric (it can be the same fabric as the seat or a contrasting fabric)

specification example

(contrasting seat, bolster and back)

STFS1L - Fractals Lounge Chair, Contrast Low Back		
1	Seat finish Gr.5	3924
2	Bolster fabric Gr.3	46
3	Back fabric Gr.9	480
Total:		\$4451

(same seat, back and contrasting bolster)

STFS1L - Fractals Lounge Chair, Contrast Low Back		
1	Seat finish Gr.5	3924
2	Bolster fabric Gr.3	46
3	Back fabric Gr.5	348
Total:		\$4319

COM/COL material requirement

Yardage is based on a non-patterned fabric. Additional yardage may be required for pattern repeats and the matching required. Leather yield may be affected by the quality of the COL. However, variance in the size of the hides will not affect the yield.

SEAT, BOLSTER AND BACK UPHOLSTERY			COM	COL
			[yards]	[sq. ft.]
Ottoman			3 1/2	63
Low-Back Lounge Chair	Seat		2 1/2	45
	Bolster		1 1/4	22 1/2
	Back		6	108
High-Back Lounge Chair	Seat		2 1/2	45
	Bolster		1 1/4	22 1/2
	Back		6	108
Low-Back Settee	Seat		4 1/2	81
	Bolster		2	36
	Back		8	144
High-Back Settee	Seat		4 1/2	81
	Bolster		2	36
	Back		8	144

specifying fractals contrasting back finishes

The modularity of Fractals permits a wide range of fabric combinations that allows for an expressive use of color, texture and material. The seat and interior back, outer back and bolster can all be finished in a different fabric if desired.

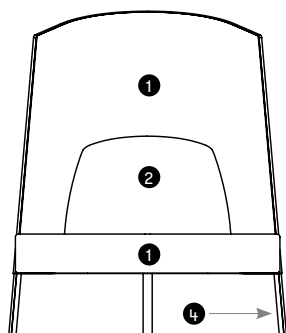

- 1 Seat & Interior Back**
Select the seat fabric
- 2 Bolster**
Select the bolster fabric (it can be the same fabric as the seat or a contrasting fabric)
- 3 Exterior Back**
Select the exterior back fabric
- 4 Frame**
Select the frame finish

specification example

STFB1L - Lounge Chair with Contrasting Back Low Back		
1	Seat & Inside Back finish Gr.5	3924
2	Bolster fabric Gr.5	58
3	Exterior Back fabric Gr.5	348
Total:		\$4330

STFB1L - Lounge Chair with Contrasting Back Low Back		
1	Seat & Inside Back finish Gr.3	3924
2	Bolster fabric Gr.5	58
3	Exterior Back fabric Gr.9	480
Total:		\$4463

STFB1L - Lounge Chair with Contrasting Back Low Back		
1	Seat & Inside Back finish Gr.5	3924
2	Bolster fabric Gr.3	46
3	Exterior Back fabric Gr.5	348
Total:		\$4319

COM/COL material requirement

Yardage is based on a non-patterned fabric. Additional yardage may be required for pattern repeats and the matching required. Leather yield may be affected by the quality of the COL. However, variance in the size of the hides will not affect the yield.

SEAT, BOLSTER AND BACK UPHOLSTERY		COM	COL
		[yards]	[sq. ft.]
Interior/Exterior Lounge	Seat & Interior Back	6	108
	Bolster	1 1/4	22 1/2
	Exterior Back	3	54
Interior/Exterior Settee	Seat & Interior Back	8	144
	Bolster	2	36
	Exterior Back	4 1/2	81

STFS fractals lounge chair

Product Options

Style	Back Height	Back Finish	Seat Upholstery	Seat Bolster Upholstery	Back Upholstery	Frame Finish
1 Lounge Chair	L Low	U Upholstery	Fabric Leather	Fabric Leather	Fabric Leather	C6 Chrome
	H High					Fundamental Paint
						Fashion Paint

Note The seat, bolster and back price must be added together for a complete price
 For Chrome, add \$0
 For Fundamental Paint, add \$64
 For Fashion Paint, add \$87

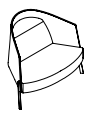

L Low Back,
H High Back,

Seat Price

COM	COL	Gr.1	Gr.2	Gr.3	Gr.4	Gr.5	Gr.6	Gr.7	Gr.8	Gr.9	Gr.10	Gr.11
2774	2941	3214	3410	3582	3778	3924	4047	4169	4316	4464	4610	4782
2913	3088	3354	3550	3721	3917	4063	4186	4308	4456	4603	4749	4921

Leather

Gr.12	Gr.13	Gr.14	Gr.15	Gr.16	Gr.17	Gr.18	Gr.19	Gr.20	LB	LC	LD
4978	5222	5467	5712	5957	6203	6447	6692	6937	5585	6908	7349
5117	5362	5606	5851	6096	6342	6586	6831	7076	5733	7055	7496



L Low Back
H High Back

Bolster Price

COM	COL	Gr.1	Gr.2	Gr.3	Gr.4	Gr.5	Gr.6	Gr.7	Gr.8	Gr.9	Gr.10	Gr.11
116	116	21	30	46	53	58	64	70	75	80	87	95
116	116	21	30	46	53	58	64	70	75	80	87	95

Leather

Gr.12	Gr.13	Gr.14	Gr.15	Gr.16	Gr.17	Gr.18	Gr.19	Gr.20	LB	LC	LD
104	116	128	139	151	162	174	186	197	394	534	580
104	116	128	139	151	162	174	186	197	394	534	580

Back Price

COM	COL	Gr.1	Gr.2	Gr.3	Gr.4	Gr.5	Gr.6	Gr.7	Gr.8	Gr.9	Gr.10	Gr.11
116	116	125	181	278	320	348	383	418	452	480	522	571
116	116	125	181	278	320	348	383	418	452	480	522	571

Leather

Gr.12	Gr.13	Gr.14	Gr.15	Gr.16	Gr.17	Gr.18	Gr.19	Gr.20	LB	LC	LD
626	696	766	835	905	974	1044	1114	1183	1786	2622	2900
626	696	766	835	905	974	1044	1114	1183	1786	2622	2900

STFS fractals settee

Product Options

Style	Back Height	Back Finish	Seat Upholstery	Seat Bolster Upholstery	Back Upholstery	Frame Finish
2 Settee	L Low	U Upholstery	Fabric	Fabric	Fabric	C6 Chrome
	H High		Leather	Leather	Leather	Fundamental Paint
						Fashion Paint

Note The seat, bolster and back price must be added together for a complete price
 For Chrome, add \$0
 For Fundamental Paint, add \$64
 For Fashion Paint, add \$87

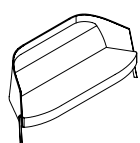

L Low Back
 H High Back

Seat Price

COM	COL	Gr.1	Gr.2	Gr.3	Gr.4	Gr.5	Gr.6	Gr.7	Gr.8	Gr.9	Gr.10	Gr.11
4565	4840	5237	5537	5798	6097	6321	6509	6696	6919	7143	7368	7629
4705	4988	5378	5677	5938	6237	6461	6649	6836	7060	7284	7509	7770

Leather

L Low Back
 H High Back

Gr.12	Gr.13	Gr.14	Gr.15	Gr.16	Gr.17	Gr.18	Gr.19	Gr.20	LB	LC	LD
7929	8302	8676	9050	9424	9797	10171	10546	10919	8876	10895	11568
8069	8442	8816	9191	9564	9938	10311	10686	11059	9025	11043	11716

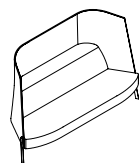

Bolster Price

L Low Back
 H High Back

COM	COL	Gr.1	Gr.2	Gr.3	Gr.4	Gr.5	Gr.6	Gr.7	Gr.8	Gr.9	Gr.10	Gr.11
116	116	42	60	93	107	116	128	139	151	160	174	190
116	116	42	60	93	107	116	128	139	151	160	174	190

Leather

L Low Back
 H High Back

Gr.12	Gr.13	Gr.14	Gr.15	Gr.16	Gr.17	Gr.18	Gr.19	Gr.20	LB	LC	LD
209	232	255	278	302	325	348	371	394	673	951	1044
209	232	255	278	302	325	348	371	394	673	951	1044

Back Price

L Low Back
 H High Back

COM	COL	Gr.1	Gr.2	Gr.3	Gr.4	Gr.5	Gr.6	Gr.7	Gr.8	Gr.9	Gr.10	Gr.11
116	116	167	241	371	427	464	510	557	603	640	696	761
116	116	167	241	371	427	464	510	557	603	640	696	761

Leather

L Low Back
 H High Back

Gr.12	Gr.13	Gr.14	Gr.15	Gr.16	Gr.17	Gr.18	Gr.19	Gr.20	LB	LC	LD
835	928	1021	1114	1206	1299	1392	1485	1578	2343	3457	3828
835	928	1021	1114	1206	1299	1392	1485	1578	2343	3457	3828

STFP fractals power

Product Options

Style	Frame Finish
1 2 Simplex/2 USB-A	52 Ebony Coordinate

Note The power unit mounts to the frame under the seat



Price
785

STFB fractals lounge chair – contrasting outer back

Product Options

Style	Back Height	Seat & Inside Back Upholstery Finish	Seat Bolster Upholstery Finish	Exterior Back Upholstery Finish	Frame Finish
1 Lounge Chair	L Low H High	Fabric Leather	Fabric Leather	Fabric Leather	C6 Chrome Fundamental Paint Fashion Paint

Note For Chrome, add \$0
For Fundamental Paint, add \$64
For Fashion Paint, add \$87

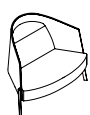

L Low Back
H High Back

Seat & Inside Back Price

COM	COL	Gr.1	Gr.2	Gr.3	Gr.4	Gr.5	Gr.6	Gr.7	Gr.8	Gr.9	Gr.10	Gr.11
2774	2941	3214	3410	3582	3778	3924	4047	4169	4316	4464	4610	4782
2913	3088	3354	3550	3721	3917	4063	4186	4308	4456	4603	4749	4921

Leather

Gr.12	Gr.13	Gr.14	Gr.15	Gr.16	Gr.17	Gr.18	Gr.19	Gr.20	LB	LC	LD
4978	5222	5467	5712	5957	6203	6447	6692	6937	5585	6908	7349
5117	5362	5606	5851	6096	6342	6586	6831	7076	5733	7055	7496



L Low Back
H High Back

Bolster Price

COM	COL	Gr.1	Gr.2	Gr.3	Gr.4	Gr.5	Gr.6	Gr.7	Gr.8	Gr.9	Gr.10	Gr.11
116	116	21	30	46	53	58	64	70	75	80	87	95
116	116	21	30	46	53	58	64	70	75	80	87	95

Leather

Gr.12	Gr.13	Gr.14	Gr.15	Gr.16	Gr.17	Gr.18	Gr.19	Gr.20	LB	LC	LD
104	116	128	139	151	162	174	186	197	125	188	209
104	116	128	139	151	162	174	186	197	125	188	209

Exterior Price

COM	COL	Gr.1	Gr.2	Gr.3	Gr.4	Gr.5	Gr.6	Gr.7	Gr.8	Gr.9	Gr.10	Gr.11
116	116	125	181	278	320	348	383	418	452	480	522	571
116	116	125	181	278	320	348	383	418	452	480	522	571

Leather

Gr.12	Gr.13	Gr.14	Gr.15	Gr.16	Gr.17	Gr.18	Gr.19	Gr.20	LB	LC	LD
626	696	766	835	905	974	1044	1114	1183	1786	2622	2900
626	696	766	835	905	974	1044	1114	1183	1786	2622	2900

STFB fractals settee – contrasting outer back

Product Options

Style	Back Height	Seat & Inside Back Upholstery Finish	Seat Bolster Upholstery Finish	Exterior Back Upholstery Finish	Frame Finish
2 Settee	L Low	Fabric	Fabric	Fabric	C6 Chrome
	H High	Leather	Leather	Leather	Fundamental Paint
					Fashion Paint

Note For Chrome, add \$0
 For Fundamental Paint, add \$64
 For Fashion Paint, add \$87

Seat & Inside Back Price

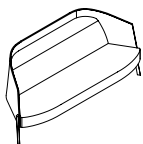

L Low Back
 H High Back

COM	COL	Gr.1	Gr.2	Gr.3	Gr.4	Gr.5	Gr.6	Gr.7	Gr.8	Gr.9	Gr.10	Gr.11
4565	4840	5237	5537	5798	6097	6321	6509	6696	6919	7143	7368	7629
4705	4988	5378	5677	5938	6237	6461	6649	6836	7060	7284	7509	7770

Leather

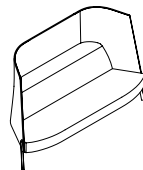

L Low Back
 H High Back

Gr.12	Gr.13	Gr.14	Gr.15	Gr.16	Gr.17	Gr.18	Gr.19	Gr.20	LB	LC	LD
7929	8302	8676	9050	9424	9797	10171	10546	10919	8876	10895	11568
8069	8442	8816	9191	9564	9938	10311	10686	11059	9025	11043	11716

Bolster Price

L Low Back
 H High Back

COM	COL	Gr.1	Gr.2	Gr.3	Gr.4	Gr.5	Gr.6	Gr.7	Gr.8	Gr.9	Gr.10	Gr.11
116	116	42	60	93	107	116	128	139	151	160	174	190
116	116	42	60	93	107	116	128	139	151	160	174	190

Leather

L Low Back
 H High Back

Gr.12	Gr.13	Gr.14	Gr.15	Gr.16	Gr.17	Gr.18	Gr.19	Gr.20	LB	LC	LD
209	232	255	278	302	325	348	371	394	673	951	1044
209	232	255	278	302	325	348	371	394	673	951	1044

Exterior Price

L Low Back
 H High Back

COM	COL	Gr.1	Gr.2	Gr.3	Gr.4	Gr.5	Gr.6	Gr.7	Gr.8	Gr.9	Gr.10	Gr.11
116	116	167	241	371	427	464	510	557	603	640	696	761
116	116	167	241	371	427	464	510	557	603	640	696	761

Leather

L Low Back
 H High Back

Gr.12	Gr.13	Gr.14	Gr.15	Gr.16	Gr.17	Gr.18	Gr.19	Gr.20	LB	LC	LD
835	928	1021	1114	1206	1299	1392	1485	1578	2343	3457	3828
835	928	1021	1114	1206	1299	1392	1485	1578	2343	3457	3828

havn

features

Havn is a Scandinavian-inspired seating collection comprising a winged lounge chair and settee. In Danish, “havn” means harbor, suggesting that this lounge chair is a good place to “dock” during the day with a coffee or a book. It’s a retreat from the norms of everyday work.

Havn enables open lounge settings or focused work with its high back. A highly sculptural back that nestles in the craft-oriented frame somewhat “pinches” it together to make the upper form. The back is wrapped organically within the wooden frame, surrounding a soft bolster pillow for comfort. The curved wooden frame cradles the upholstered seat with a carefully crafted void in the rear that makes it visually stunning.

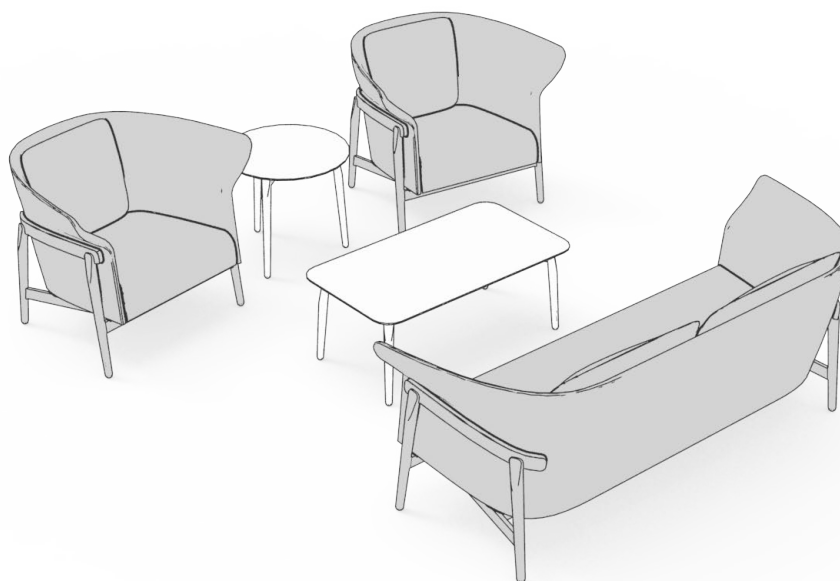

dimensions

- Designed and tested for users up to 300 lbs
- Meets ANSI/BIFMA requirements

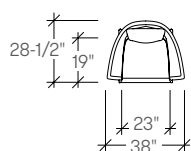

Havn Lounge Chair,
Low Back
(STNE)

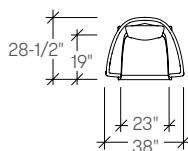

Havn Lounge Chair,
High Back
(STNF)

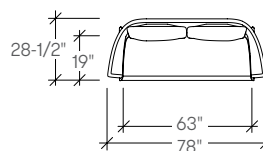

Havn Sofa, Low Back
(STNG)

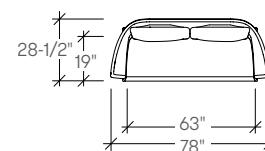

Havn Sofa, High Back
(STNH)

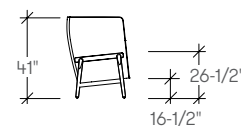
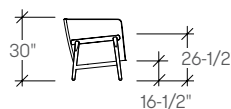
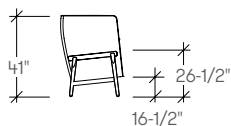
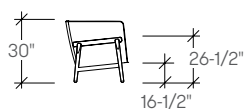

havn

planning

A variety of configurations can be achieved with Havn, allowing for various configurations. The following typical demonstrate the versatility that can be achieved.

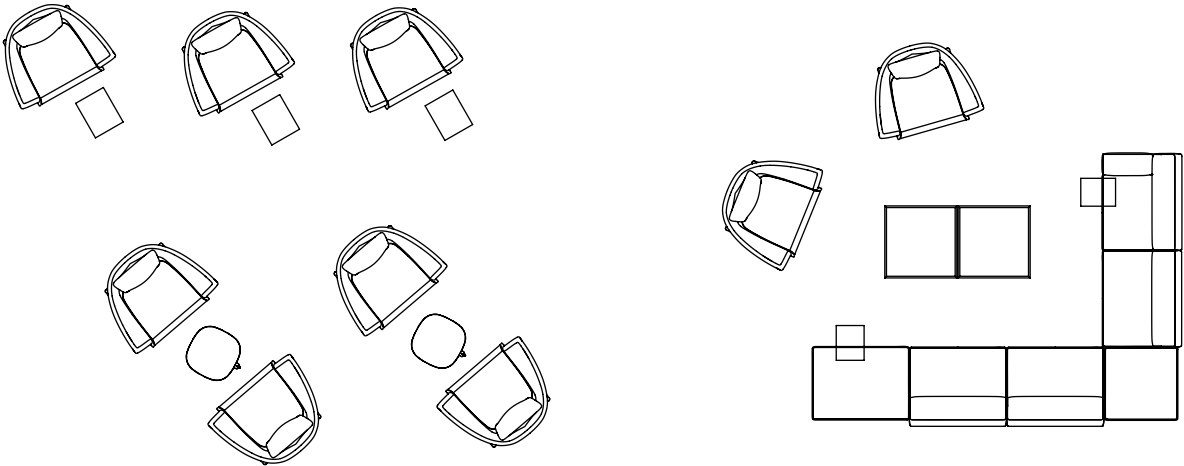
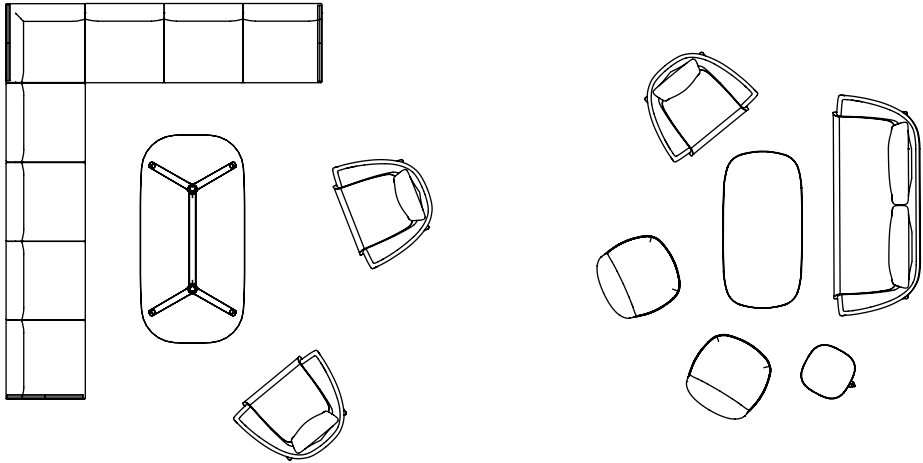
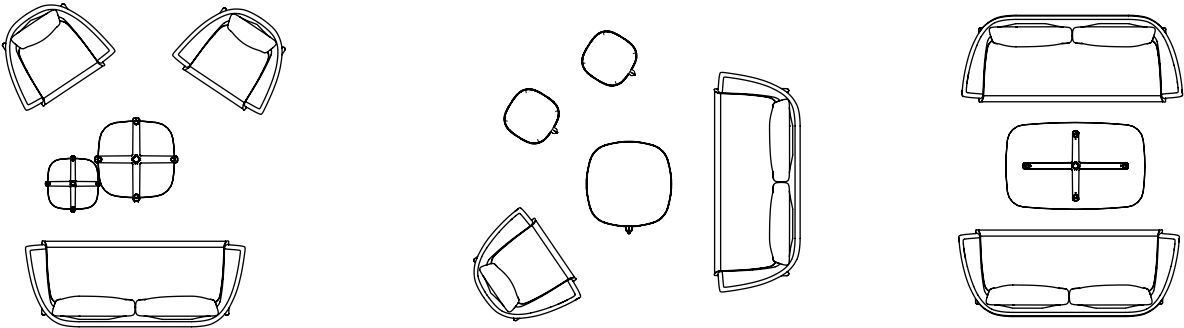

specifying havn finishes

The modularity of Havn permits a wide range of fabric combinations that allows for an expressive use of color, texture and material.

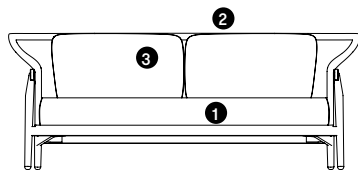

- 1 Seat Upholstery**
Select the seat upholstery
- 2 Back Upholstery**
Select the back upholstery
- 3 Bolster Finish**
Select bolster pillow upholstery

specification example

STNE Havn Lounge Chair, Low Back	
1 Seat fabric Gr.5	4524
2 Back fabric Gr.8	650
3 Bolster finish Gr.3	130
Total:	\$5304

STNG Havn Sofa, Low Back	
1 Seat fabric Gr.3	6546
2 Back fabric Gr.5	908
3 Bolster finish Gr.3	345
Total:	\$7799

STNF Havn Lounge Chair, High Back	
1 Seat fabric Gr.5	4772
2 Back fabric Gr.8	1218
3 Bolster finish Gr.3	130
Total:	\$6120

STNH Havn Sofa, High Back	
1 Seat fabric Gr.3	6794
2 Back fabric Gr.5	1121
3 Base Upholstery Gr.3	345
Total:	\$8259

weights

Havn Lounge Chair, Low Back	60 - 65 lbs
Havn Lounge Chair, High Back	65 - 70 lbs
Havn Sofa, Low Back	130 - 140 lbs
Havn Sofa, High Back	140 - 150 lbs

COM/COL material requirement

Yardage is based on a non-patterned fabric. Additional yardage may be required for pattern repeats and the matching required. Leather yield may be affected by the quality of the COL. However, variance in the size of the hides will not affect the yield.

SEAT, BOLSTER AND BACK UPHOLSTERY		COM	COL
		[yards]	[sq. ft.]
Low Back Lounge	Seat	1 1/2	27
	Bolster	1 1/2	27
	Back	4	72
High Back Lounge	Seat	1 1/2	27
	Bolster	1 1/2	27
	Back	7 1/2	135
Low Back Settee	Seat	4	72
	Bolster	4	72
	Back	7 1/2	135
High Back Settee	Seat	4	72
	Bolster	4	72
	Back	9 1/4	167

STNF havn lounge chair, high back

Product Options

Seat Upholstery Finish	Back Upholstery Finish	Bolster Cushion Upholstery Finish	Frame Wood Finish
Fabric	Fabric	Fabric	BU Basque White Oak
Leather	Leather	Leather	NK Natural Oak
			DY Cocoa Brown
			DV Sierra
			DZ Truffle



Seat Upholstery Finish Price

COM	COL	Gr.1	Gr.2	Gr.3	Gr.4	Gr.5	Gr.6	Gr.7	Gr.8	Gr.9	Gr.10	Gr.11
4590	4866	4660	4691	4718	4749	4772	4791	4811	4834	4857	4880	4907

Leather

Gr.12	Gr.13	Gr.14	Gr.15	Gr.16	Gr.17	Gr.18	Gr.19	Gr.20	LB	LC	LD
4938	4976	5016	5054	5092	5132	5170	5208	5248	5284	5493	5562

Back Upholstery Finish Price

COM	COL	Gr.1	Gr.2	Gr.3	Gr.4	Gr.5	Gr.6	Gr.7	Gr.8	Gr.9	Gr.10	Gr.11
0	0	348	502	638	792	908	1006	1102	1218	1334	1450	1586

Leather

Gr.12	Gr.13	Gr.14	Gr.15	Gr.16	Gr.17	Gr.18	Gr.19	Gr.20	LB	LC	LD
1740	1934	2126	2320	2514	2706	2900	3094	3286	2088	3132	3480

Bolster Upholstery Finish Price

COM	COL	Gr.1	Gr.2	Gr.3	Gr.4	Gr.5	Gr.6	Gr.7	Gr.8	Gr.9	Gr.10	Gr.11
0	0	72	102	130	160	183	203	223	246	269	292	319

Leather

Gr.12	Gr.13	Gr.14	Gr.15	Gr.16	Gr.17	Gr.18	Gr.19	Gr.20	LB	LC	LD
350	389	427	466	505	543	582	621	659	418	626	696

STNH havn sofa, high back

Product Options

Seat Upholstery Finish	Back Upholstery Finish	Bolster Cushion Upholstery Finish	Frame Wood Finish
Fabric	Fabric	Fabric	BU Basque White Oak
Leather	Leather	Leather	NK Natural Oak
			DY Cocoa Brown
			DV Sierra
			DZ Truffle



Seat Upholstery Finish Price

COM	COL	Gr.1	Gr.2	Gr.3	Gr.4	Gr.5	Gr.6	Gr.7	Gr.8	Gr.9	Gr.10	Gr.11
6454	6843	6640	6722	6794	6876	6939	6990	7042	7104	7165	7228	7300
										Leather		
Gr.12	Gr.13	Gr.14	Gr.15	Gr.16	Gr.17	Gr.18	Gr.19	Gr.20		LB	LC	LD
7382	7485	7589	7692	7795	7897	8001	8104	8207		7956	8513	8699

Back Upholstery Finish Price

COM	COL	Gr.1	Gr.2	Gr.3	Gr.4	Gr.5	Gr.6	Gr.7	Gr.8	Gr.9	Gr.10	Gr.11
0	0	429	619	786	978	1121	1240	1360	1502	1645	1789	1956
										Leather		
Gr.12	Gr.13	Gr.14	Gr.15	Gr.16	Gr.17	Gr.18	Gr.19	Gr.20		LB	LC	LD
2146	2385	2623	2862	3100	3338	3576	3815	4053		2575	3863	4292

Bolster Upholstery Finish Price

COM	COL	Gr.1	Gr.2	Gr.3	Gr.4	Gr.5	Gr.6	Gr.7	Gr.8	Gr.9	Gr.10	Gr.11
0	0	190	273	345	427	490	541	593	654	716	778	850
										Leather		
Gr.12	Gr.13	Gr.14	Gr.15	Gr.16	Gr.17	Gr.18	Gr.19	Gr.20		LB	LC	LD
933	1036	1139	1242	1346	1448	1551	1654	1757		1114	1670	1856

infinito

features

Infinito brings a traditional lounge look with a not-so-classic feel to any scenario. Designed with an intentional, rigid exterior and a soft, relaxed interior, Infinito brings the comforts of home to the office. Available in Lounge Chair, Settee and Three-Seat Sofa configurations with contrasting textile applications possible for multiple variations of color.

Infinito sectional provides all the same comfort and modularity as the Infinito Lounge collection, with an even more lifestyle personality. Ideal for lounges, greeting spaces and public areas, Infinito can be reconfigured in infinite ways since each piece has the same footprint. The Infinito sectional provides even more ability for social connectivity and community.

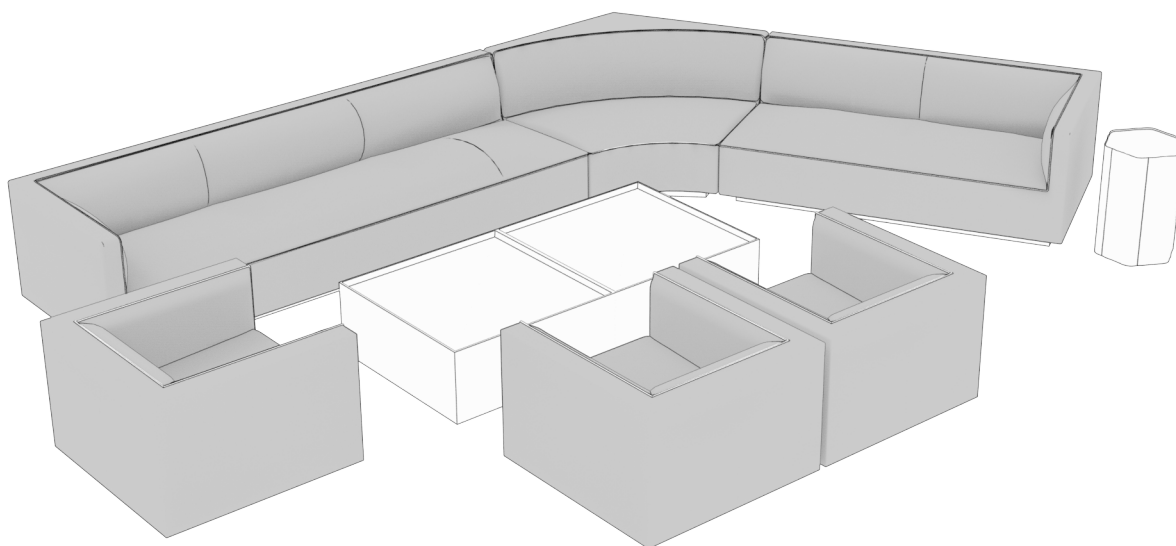

dimensions

- Designed and tested for users up to 300 lbs
- Meets ANSI/BIFMA requirements

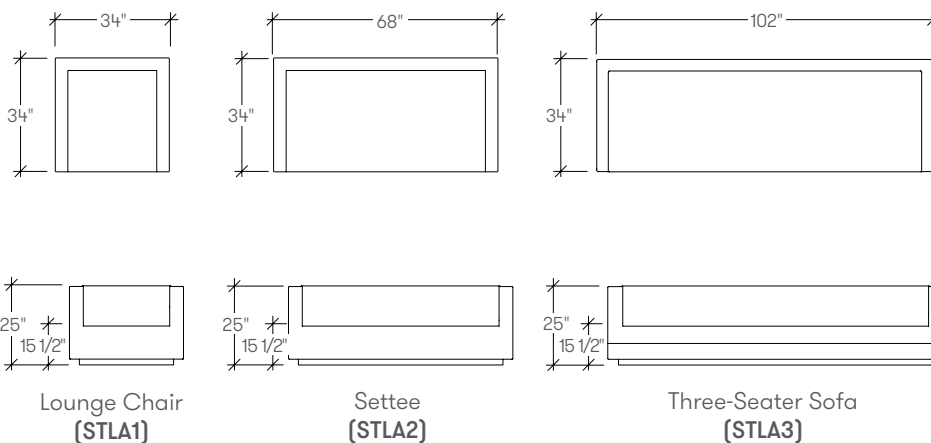

dimensions

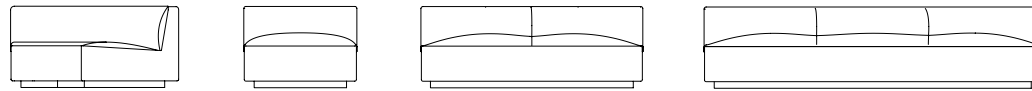
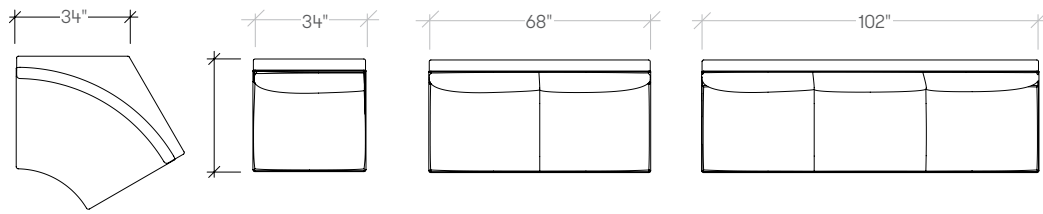

Sectional Corner
(STLAC)

Sectional Armless
(STLAD)

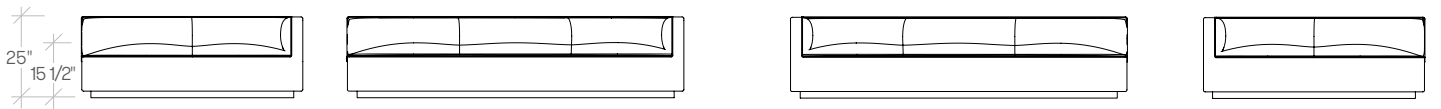
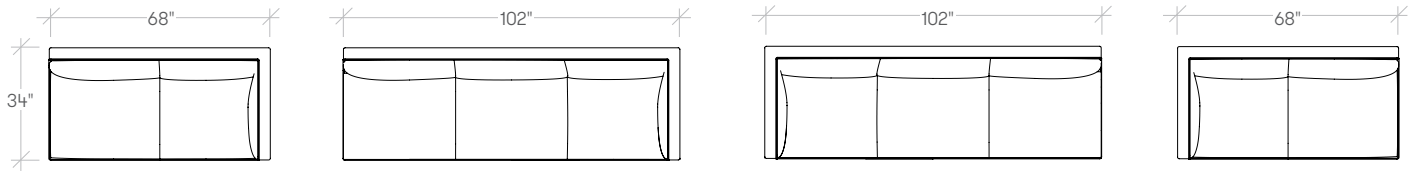

Sectional RSF Arm LSF Armless
(STLAE)

Sectional LSF Arm RSF Armless
(STLAF)

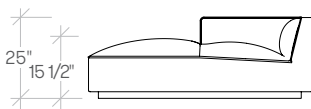
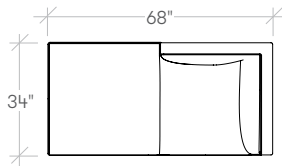

Sectional Chaise
(STLAG)

Note Arm cannot be used as corner
RSF - Right Side Facing the seat
LSF - Left Side Facing the seat

infinito

planning

A variety of configurations can be achieved with Infinito paired with other Studio TK pieces, allowing for various configurations. The following typical demonstrate the versatility that can be achieved. All units are built on the same footprint, providing maximum flexibility.

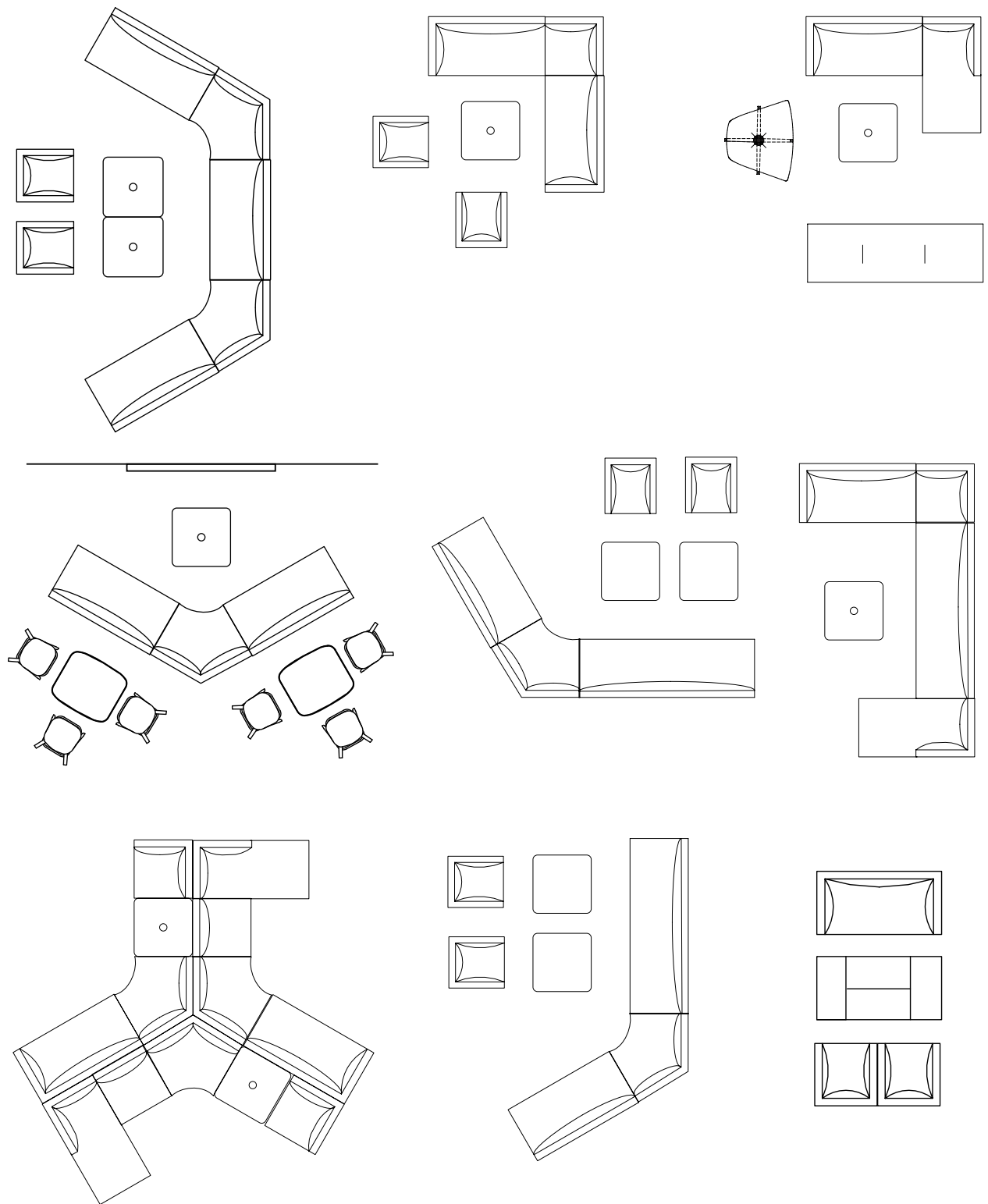

specifying infinito finishes

The modularity of Infinito permits a wide range of fabric combinations that allows for an expressive use of color, texture and material. The outer frame upholstery, the inner seat upholstery and the seat welt upholstery can all be finished in a different fabric if desired.

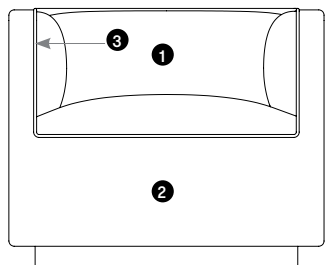

- 1 Inside Upholstery Finish**
Select the inside upholstery
- 2 Outside Upholstery Finish**
Select the outside upholstery
- 3 Welt Upholstery Finish**
Select the welt upholstery

specification example

STLA1 – Infinito Lounge Chair		
1	Outer frame fabric Gr.5	3536
2	Inner seat fabric Gr.5	150
3	Welt fabric Gr.5	95
Total:		\$3781

STLA1 – Infinito Lounge Chair		
1	Outer frame fabric Gr.5	3536
2	Inner seat fabric Gr.3	106
3	Welt fabric Gr.3	67
Total:		\$3709

STLA1 – Infinito Lounge Chair		
1	Outer frame fabric Gr.5	3536
2	Inner seat fabric Gr.9	220
3	Welt fabric Gr.12	183
Total:		\$3939

weights

Infinito, Lounge, Lounge Chair	80 - 85 lbs
Infinito, Lounge, Settee	140 - 150 lbs
Infinito, Lounge, Sofa	215 - 225 lbs
Infinito, Corner 90°	75 - 80 lbs
Infinito, Corner 120°	95 - 105 lbs
Infinito, Sectional Armless, One Seater	70 - 75 lbs
Infinito, Sectional Armless, Two Seater	120 - 130 lbs
Infinito, Sectional Armless, Three Seater	195 - 205 lbs
Infinito, Sectional Arm RSF - Armless LSF, Two Seater	130 - 140 lbs
Infinito, Sectional Arm RSF - Armless LSF, Three Seater	205 - 215 lbs
Infinito, Sectional Arm LSF - Armless RSF, Two Seater	130 - 140 lbs
Infinito, Sectional Arm LSF - Armless RSF, Three Seater	205 - 215 lbs
Infinito, Sectional Chaise, Right Arm	120 - 130 lbs
Infinito, Sectional Chaise, Left Arm	120 - 130 lbs

COM/COL material requirement

Yardage is based on a non-patterned fabric. Additional yardage may be required for pattern repeats and the matching required. Leather yield may be affected by the quality of the COL. However, variance in the size of the hides will not affect the yield.

SINGLE UPHOLSTERY

		COM [yards]	COL [sq. ft.]
Infinito Lounge	Inside	2 3/4	49 1/2
	Outside	3 3/4	67 1/2
	Welt	1 3/4	31 1/2
Infinito Settee	Inside	4	72
	Outside	4 1/2	81
	Welt	1 3/4	31 1/2
Infinito Sofa	Inside	5 1/2	99
	Outside	6 1/4	112 1/2
	Welt	1 3/4	31 1/2
Infinito 90 Corner	Inside	2 1/2	45
	Outside	3 1/2	63
	Welt	1 3/4	31 1/2
Infinito 120 Corner	Inside	4	72
	Outside	3 1/4	58 1/2
	Welt	1 3/4	31 1/2
Infinito Armless Single Seat	Inside	2 1/4	40 1/2
	Outside	3 1/4	58 1/2
	Welt	1 3/4	31 1/2
Infinito Armless Two Seat	Inside	3 1/2	63
	Outside	4	72
	Welt	1 3/4	31 1/2
Infinito Armless Three Seat	Inside	5 1/2	99
	Outside	5	90
	Welt	1 3/4	31 1/2
Infinito One Arm, Two Seat	Inside	4	72
	Outside	4	72
	Welt	1 3/4	31 1/2
Infinito One Arm, Three Seat	Inside	5 1/2	99
	Outside	5 1/2	99
	Welt	1 3/4	31 1/2
Infinito Chaise	Inside	4	72
	Outside	4 1/2	81
	Welt	1 3/4	31 1/2

STLA infinito lounge

Product Options

Style	Outer Frame Upholstery Finish	Inner Seat & Back Upholstery Finish	Welt Upholstery Finish
1 Lounge Chair	Fabric	Fabric	Fabric
2 Settee			
3 Three Seat Sofa			
	Leather	Leather	Leather

Outer Frame

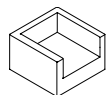

	COM	COL	Gr.1	Gr.2	Gr.3	Gr.4	Gr.5	Gr.6	Gr.7	Gr.8	Gr.9	Gr.10	Gr.11
1 Lounge Chair	2566	2822	2937	3102	3247	3412	3536	3638	3741	3865	3989	4112	4257
2 Settee	3603	3964	4079	4290	4475	4686	4845	4976	5109	5268	5426	5584	5770
3 Three Seat Sofa	4804	5284	5592	5943	6250	6600	6864	7082	7301	7564	7828	8090	8397

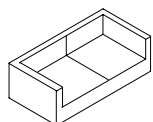

	Gr.12	Gr.13	Gr.14	Gr.15	Gr.16	Gr.17	Gr.18	Gr.19	Gr.20	Leather		
										LB	LC	LD
1 Lounge Chair	4422	4628	4835	5040	5247	5453	5660	5865	6071	5049	6163	6534
2 Settee	5981	6245	6510	6773	7038	7302	7567	7830	8094	6817	8244	8720
3 Three Seat Sofa	8748	9186	9625	10062	10500	10939	11377	11815	12253	10017	12383	13172

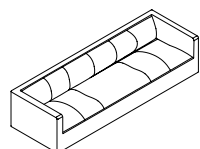

Inner Seat & Back

	COM	COL	Gr.1	Gr.2	Gr.3	Gr.4	Gr.5	Gr.6	Gr.7	Gr.8	Gr.9	Gr.10	Gr.11
1 Lounge Chair	116	116	58	84	106	131	150	166	182	201	220	239	262
2 Settee	116	116	84	121	153	190	218	241	264	292	320	348	380
3 Three Seat Sofa	116	116	115	166	211	262	300	332	364	403	441	479	523

	Gr.12	Gr.13	Gr.14	Gr.15	Gr.16	Gr.17	Gr.18	Gr.19	Gr.20	Leather		
										LB	LC	LD
1 Lounge Chair	288	319	351	383	415	447	479	510	543	345	517	574
2 Settee	418	464	510	557	603	650	696	742	789	501	752	835
3 Three Seat Sofa	574	638	702	766	829	893	957	1021	1085	689	1034	1148

Welt Upholstery

	COM	COL	Gr.1	Gr.2	Gr.3	Gr.4	Gr.5	Gr.6	Gr.7	Gr.8	Gr.9	Gr.10	Gr.11
1 Lounge Chair	116	116	37	53	67	84	95	106	116	128	140	152	167
2 Settee	116	116	37	53	67	84	95	106	116	128	140	152	167
3 Three Seat Sofa	116	116	37	53	67	84	95	106	116	128	140	152	167

	Gr.12	Gr.13	Gr.14	Gr.15	Gr.16	Gr.17	Gr.18	Gr.19	Gr.20	Leather		
										LB	LC	LD
1 Lounge Chair	183	203	224	244	264	284	305	325	346	219	329	365
2 Settee	183	203	224	244	264	284	305	325	346	219	329	365
3 Three Seat Sofa	183	203	224	244	264	284	305	325	346	219	329	365

STLAC infinito sectional corner

Product Options

Style	Outer Frame Upholstery Finish	Inner Seat & Back Upholstery Finish	Welt Upholstery Finish
1 90° Corner	Fabric Leather	Fabric Leather	Fabric Leather
2 120° Corner			

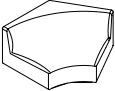
		Outer Frame												
		COM	COL	Gr.1	Gr.2	Gr.3	Gr.4	Gr.5	Gr.6	Gr.7	Gr.8	Gr.9	Gr.10	Gr.11
	1 90° Corner	2995	3294	3366	3531	3676	3841	3965	4067	4170	4294	4418	4541	4686
	2 120° Corner	3710	4081	4081	4246	4391	4555	4679	4782	4885	5009	5133	5256	5401
		Leather												
		Gr.12	Gr.13	Gr.14	Gr.15	Gr.16	Gr.17	Gr.18	Gr.19	Gr.20	LB	LC	LD	
	1 90° Corner	4851	5058	5264	5469	5676	5882	6089	6294	6501	5522	6635	7006	
	2 120° Corner	5566	5772	5979	6184	6390	6597	6803	7009	7215	6308	7422	7793	
		Inner Seat & Back												
		COM	COL	Gr.1	Gr.2	Gr.3	Gr.4	Gr.5	Gr.6	Gr.7	Gr.8	Gr.9	Gr.10	Gr.11
	1 90° Corner	116	116	52	75	96	119	137	151	166	183	201	218	238
	2 120° Corner	116	116	84	121	153	190	218	241	264	292	320	348	380
		Leather												
		Gr.12	Gr.13	Gr.14	Gr.15	Gr.16	Gr.17	Gr.18	Gr.19	Gr.20	LB	LC	LD	
	1 90° Corner	261	290	319	348	377	406	435	464	493	313	470	522	
	2 120° Corner	418	464	510	557	603	650	696	742	789	501	752	835	
		Welt Upholstery												
		COM	COL	Gr.1	Gr.2	Gr.3	Gr.4	Gr.5	Gr.6	Gr.7	Gr.8	Gr.9	Gr.10	Gr.11
	1 90° Corner	116	116	37	53	67	84	95	106	116	128	140	152	167
	2 120° Corner	116	116	37	53	67	84	95	106	116	128	140	152	167
		Leather												
		Gr.12	Gr.13	Gr.14	Gr.15	Gr.16	Gr.17	Gr.18	Gr.19	Gr.20	LB	LC	LD	
	1 90° Corner	183	203	224	244	264	284	305	325	346	219	329	365	
	2 120° Corner	183	203	224	244	264	284	305	325	346	219	329	365	

STLAD infinito sectional armless

Product Options

Style	Outer Frame Upholstery Finish	Inner Seat & Back Upholstery Finish	Welt Upholstery Finish
1 One Seater	Fabric	Fabric	Fabric
2 Two Seater			
3 Three Seater			
	Leather	Leather	Leather

Outer Frame

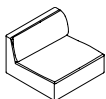

- 1 One Seater
- 2 Two Seater
- 3 Three Seater

COM	COL	Gr.1	Gr.2	Gr.3	Gr.4	Gr.5	Gr.6	Gr.7	Gr.8	Gr.9	Gr.10	Gr.11
2538	2792	2770	2873	2964	3067	3144	3209	3272	3350	3428	3504	3595
3538	3892	3909	4074	4219	4384	4508	4610	4713	4837	4961	5084	5229
4741	5215	5344	5612	5846	6114	6316	6483	6651	6852	7053	7255	7489

Leather

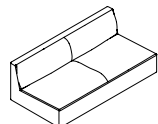

- 1 One Seater
- 2 Two Seater
- 3 Three Seater

Gr.12	Gr.13	Gr.14	Gr.15	Gr.16	Gr.17	Gr.18	Gr.19	Gr.20	Gr.8	Gr.9	Gr.10	Gr.11
3698	3827	3956	4084	4213	4343	4472	4601	4729	4184	4880	5112	
5394	5600	5807	6012	6219	6425	6632	6837	7044	6119	7233	7604	
7757	8092	8427	8763	9098	9432	9767	10102	10438	8835	10644	11247	

LB	LC	LD
4184	4880	5112
6119	7233	7604
8835	10644	11247

Inner Seat & Back

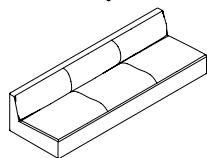

- 1 One Seater
- 2 Two Seater
- 3 Three Seater

COM	COL	Gr.1	Gr.2	Gr.3	Gr.4	Gr.5	Gr.6	Gr.7	Gr.8	Gr.9	Gr.10	Gr.11
116	116	48	68	86	107	123	136	148	165	180	196	215
116	116	73	106	135	167	191	211	232	256	281	305	333
116	116	115	166	211	262	300	332	364	403	441	479	523

Leather

- 1 One Seater
- 2 Two Seater
- 3 Three Seater

Gr.12	Gr.13	Gr.14	Gr.15	Gr.16	Gr.17	Gr.18	Gr.19	Gr.20	Gr.8	Gr.9	Gr.10	Gr.11
235	261	288	313	340	365	392	418	444	282	423	470	
365	406	447	487	528	568	609	650	690	438	658	731	
574	638	702	766	829	893	957	1021	1085	689	1034	1148	

LB	LC	LD
282	423	470
438	658	731
689	1034	1148

Welt Upholstery

- 1 One Seater
- 2 Two Seater
- 3 Three Seater

COM	COL	Gr.1	Gr.2	Gr.3	Gr.4	Gr.5	Gr.6	Gr.7	Gr.8	Gr.9	Gr.10	Gr.11
116	116	37	53	67	84	95	106	116	128	140	152	167
116	116	37	53	67	84	95	106	116	128	140	152	167
116	116	37	53	67	84	95	106	116	128	140	152	167

Leather

- 1 One Seater
- 2 Two Seater
- 3 Three Seater

Gr.12	Gr.13	Gr.14	Gr.15	Gr.16	Gr.17	Gr.18	Gr.19	Gr.20	Gr.8	Gr.9	Gr.10	Gr.11
183	203	224	244	264	284	305	325	346	219	329	365	
183	203	224	244	264	284	305	325	346	219	329	365	
183	203	224	244	264	284	305	325	346	219	329	365	

LB	LC	LD
219	329	365
219	329	365
219	329	365

STLAE infinito sectional arm RSF – armless LSF

Product Options

Style	Outer Frame Upholstery Finish	Inner Seat & Back Upholstery Finish	Welt Upholstery Finish
2 Two Seater	Fabric Leather	Fabric Leather	Fabric Leather
3 Three Seater			

Note Arm should not be used as an alternate back or corner unit, to turn sectional corners, you must specify a corner unit.
 RSF - Right Side Facing the seat
 LSF - Left Side Facing the seat

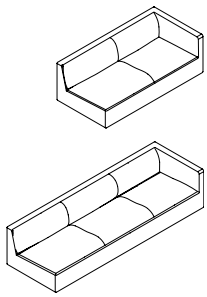

Outer Frame

	COM	COL	Gr.1	Gr.2	Gr.3	Gr.4	Gr.5	Gr.6	Gr.7	Gr.8	Gr.9	Gr.10	Gr.11
2 Two Seater	3596	3956	4014	4199	4362	4547	4686	4802	4918	5058	5197	5336	5498
3 Three Seater	4768	5244	5464	5773	6044	6353	6585	6778	6972	7204	7436	7668	7938

Leather

	Gr.12	Gr.13	Gr.14	Gr.15	Gr.16	Gr.17	Gr.18	Gr.19	Gr.20	LB	LC	LD
2 Two Seater	5684	5916	6148	6380	6612	6844	7076	7308	7540	6461	7714	8132
3 Three Seater	8248	8634	9021	9408	9794	10181	10568	10954	11341	9420	11508	12204

Inner Seat & Back

	COM	COL	Gr.1	Gr.2	Gr.3	Gr.4	Gr.5	Gr.6	Gr.7	Gr.8	Gr.9	Gr.10	Gr.11
2 Two Seater	116	116	84	121	153	190	218	241	264	292	320	348	380
3 Three Seater	116	116	115	166	211	262	300	332	364	403	441	479	523

Leather

	Gr.12	Gr.13	Gr.14	Gr.15	Gr.16	Gr.17	Gr.18	Gr.19	Gr.20	LB	LC	LD
2 Two Seater	418	464	510	557	603	650	696	742	789	501	752	835
3 Three Seater	574	638	702	766	829	893	957	1021	1085	689	1034	1148

Welt Upholstery

	COM	COL	Gr.1	Gr.2	Gr.3	Gr.4	Gr.5	Gr.6	Gr.7	Gr.8	Gr.9	Gr.10	Gr.11
2 Two Seater	116	116	37	53	67	84	95	106	116	128	140	152	167
3 Three Seater	116	116	37	53	67	84	95	106	116	128	140	152	167

Leather





	Gr.12	Gr.13	Gr.14	Gr.15	Gr.16	Gr.17	Gr.18	Gr.19	Gr.20	LB	LC	LD
2 Two Seater	183	203	224	244	264	284	305	325	346	219	329	365
3 Three Seater	183	203	224	244	264	284	305	325	346	219	329	365

STLAF infinito sectional arm LSF – armless RSF

Product Options

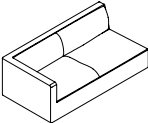
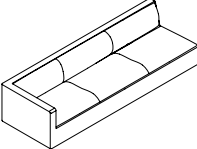
Style	Outer Frame Upholstery Finish	Inner Seat & Back Upholstery Finish	Welt Upholstery Finish
2 Two Seater	Fabric	Fabric	Fabric
3 Three Seater			
	Leather	Leather	Leather

Note Arm should not be used as an alternate back or corner unit, to turn sectional corners, you must specify a corner unit.
 RSF - Right Side Facing the seat
 LSF - Left Side Facing the seat

		Outer Frame												
		COM	COL	Gr.1	Gr.2	Gr.3	Gr.4	Gr.5	Gr.6	Gr.7	Gr.8	Gr.9	Gr.10	Gr.11
	2 Two Seater	3596	3956	4014	4199	4362	4547	4686	4802	4918	5058	5197	5336	5498
	3 Three Seater	4768	5244	5464	5773	6044	6353	6585	6778	6972	7204	7436	7668	7938
		Leather												
		Gr.12	Gr.13	Gr.14	Gr.15	Gr.16	Gr.17	Gr.18	Gr.19	Gr.20	LB	LC	LD	
	2 Two Seater	5684	5916	6148	6380	6612	6844	7076	7308	7540	6461	7714	8132	
	3 Three Seater	8248	8634	9021	9408	9794	10181	10568	10954	11341	9420	11508	12204	
		Inner Seat & Back												
		COM	COL	Gr.1	Gr.2	Gr.3	Gr.4	Gr.5	Gr.6	Gr.7	Gr.8	Gr.9	Gr.10	Gr.11
	2 Two Seater	116	116	84	121	153	190	218	241	264	292	320	348	380
	3 Three Seater	116	116	115	166	211	262	300	332	364	403	441	479	523
		Leather												
		Gr.12	Gr.13	Gr.14	Gr.15	Gr.16	Gr.17	Gr.18	Gr.19	Gr.20	LB	LC	LD	
	2 Two Seater	418	464	510	557	603	650	696	789	789	501	752	835	
	3 Three Seater	574	638	702	766	829	893	957	1085	1085	689	1034	1148	
		Welt Upholstery												
		COM	COL	Gr.1	Gr.2	Gr.3	Gr.4	Gr.5	Gr.6	Gr.7	Gr.8	Gr.9	Gr.10	Gr.11
	2 Two Seater	116	116	37	53	67	84	95	106	116	128	140	152	167
	3 Three Seater	116	116	37	53	67	84	95	106	116	128	140	152	167
		Leather												
		Gr.12	Gr.13	Gr.14	Gr.15	Gr.16	Gr.17	Gr.18	Gr.19	Gr.20	LB	LC	LD	
	2 Two Seater	183	203	224	244	264	284	305	325	346	219	329	365	
	3 Three Seater	183	203	224	244	264	284	305	325	346	219	329	365	

STLAG infinito sectional chaise

Product Options

Style	Outer Frame Upholstery Finish	Inner Seat & Back Upholstery Finish	Welt Upholstery Finish
R RSF Arm	Fabric Leather	Fabric Leather	Fabric Leather
L LSF Arm			

Note RSF - Right Side Facing the seat
LSF - Left Side Facing the seat

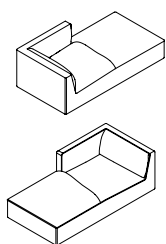

Outer Frame

Style	COM	COL	Gr.1	Gr.2	Gr.3	Gr.4	Gr.5	Gr.6	Gr.7	Gr.8	Gr.9	Gr.10	Gr.11
R RSF Arm	3596	3956	3967	4132	4277	4442	4566	4668	4771	4895	5019	5142	5287
L LSF Arm	3596	3956	3967	4132	4277	4442	4566	4668	4771	4895	5019	5142	5287

Leather

Style	Gr.12	Gr.13	Gr.14	Gr.15	Gr.16	Gr.17	Gr.18	Gr.19	Gr.20	LB	LC	LD
R RSF Arm	5452	5658	5865	6070	6277	6483	6690	6895	7102	6183	7296	7668
L LSF Arm	5452	5658	5865	6070	6277	6483	6690	6895	7102	6183	7296	7668

Inner Seat & Back

Style	COM	COL	Gr.1	Gr.2	Gr.3	Gr.4	Gr.5	Gr.6	Gr.7	Gr.8	Gr.9	Gr.10	Gr.11
R RSF Arm	116	116	84	121	153	190	218	241	264	292	320	348	380
L LSF Arm	116	116	84	121	153	190	218	241	264	292	320	348	380

Leather

Style	Gr.12	Gr.13	Gr.14	Gr.15	Gr.16	Gr.17	Gr.18	Gr.19	Gr.20	LB	LC	LD
R RSF Arm	418	464	510	557	603	650	696	742	789	501	752	835
L LSF Arm	418	464	510	557	603	650	696	742	789	501	752	835

Welt Upholstery

Style	COM	COL	Gr.1	Gr.2	Gr.3	Gr.4	Gr.5	Gr.6	Gr.7	Gr.8	Gr.9	Gr.10	Gr.11
R RSF Arm	116	116	37	53	67	84	95	106	116	128	140	152	167
L LSF Arm	116	116	37	53	67	84	95	106	116	128	140	152	167

Leather

Style	Gr.12	Gr.13	Gr.14	Gr.15	Gr.16	Gr.17	Gr.18	Gr.19	Gr.20	LB	LC	LD
R RSF Arm	183	203	224	244	264	284	305	325	346	219	329	365
L LSF Arm	183	203	224	244	264	284	305	325	346	219	329	365

jima by Artifort

features

Offered through a partnership with Artifort in Schijndel, The Netherlands, Jima is a sleek, expressive chair that fits seamlessly into different worlds – home or office. Particularly noteworthy is the single, flowing line running from the top of the back, via the arms to the bottom of the seat. This makes it appear as if the seat cushion is locked in an embrace, providing ergonomic perfection and maximum comfort. Designed by Paris based Patrick Norguet.

Jima is available in three versions: a steel 4-legged base, an elegant swivel star-base, and a 5-legged height-adjustable swivel base with castors. The chair is offered in an extensive range of fabrics and colors, encouraging and accommodating any interior style.



jima by Artifort

dimensions

- Designed and tested for users up to 110kg/242 lbs
- Meets standard European NEN-16139 requirements

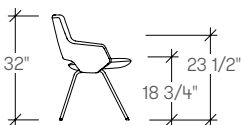
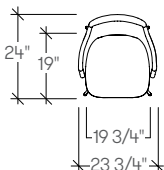

Jima Chair,
Four Leg Base,
Low Back
(ARJAL)

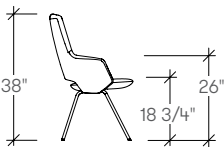
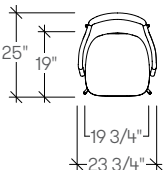

Jima Chair,
Four Leg Base,
High Back
(ARJAH)

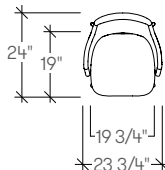

Jima Chair,
Four-Star Swivel Base
Low Back
(ARJBL)

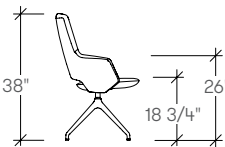
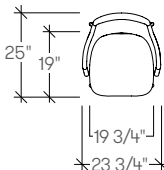

Jima Chair,
Four-Star Swivel Base
High Back
(ARJBH)

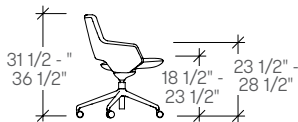
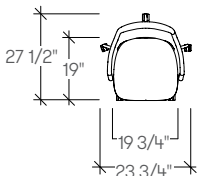

Jima Chair,
Five-Star Task Base
Low Back
(ARJCL)

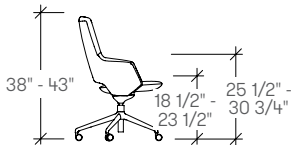
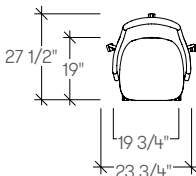

Jima Chair,
Five-Star Task Base
High Back
(ARJCH)

jima by Artifort

planning

A variety of configurations can be achieved with Jima Chair, allowing for various configurations. The following typical demonstrate the versatility that can be achieved.

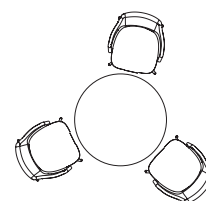
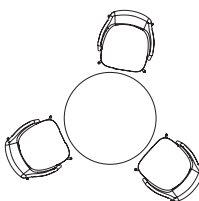
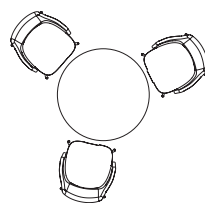
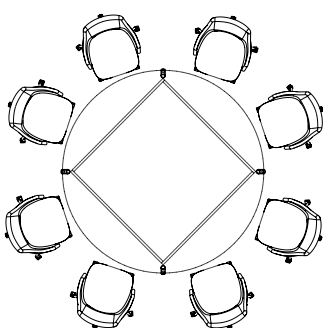
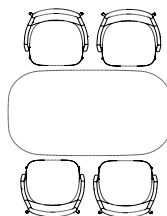
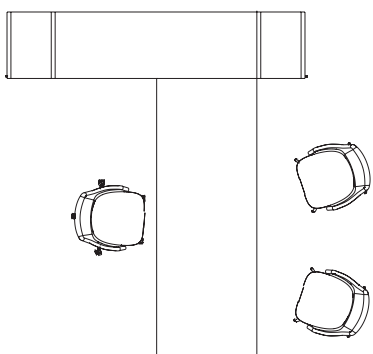
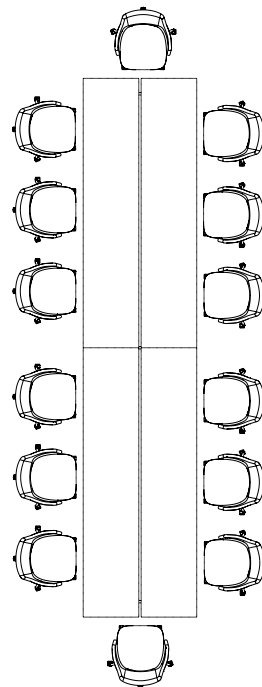
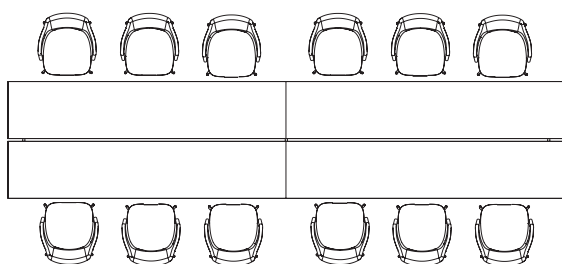

specifying jima finishes

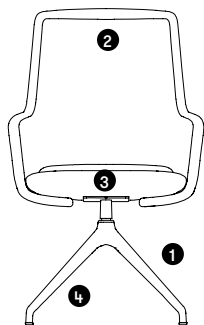

- 1 Base Style**
Select the base style
- 2 Back Height**
Select the back height
- 3 Seat Upholstery**
Select the seat upholstery
- 4 Base Finish**
Select the base finish, if applicable

specification example

ARJAL Jima Chair, Four-Star Base, Low Back	
1 Seat and Back fabric Gr.3	1675
Total:	\$1675

ARJAL Jima Chair, Four-Star Base, Low Back	
1 Seat and Back fabric Gr.8	1829
Total:	\$1829

ARJBL Jima Chair, Four-Star Swivel Base, Low Back	
1 Seat and Back fabric Gr.3	1870
Total:	\$1870

ARJBL Jima Chair, Four-Star Swivel Base, Low Back	
1 Seat and Back fabric Gr.8	2024
Total:	\$2024

ARJCL Jima Chair, Five-Star Task Base, Low Back	
1 Seat and Back fabric Gr.3	1930
Total:	\$1930

ARJCL Jima Chair, Five-Star Task Base, Low Back	
1 Seat and Back fabric Gr.8	2085
Total:	\$2085

weights

Jima Chair, Four-Star Base, Low Back	21 - 25 lbs
Jima Chair, Four-Star Base, High Back	25 - 30 lbs
Jima Chair, Four-Star Swivel Base, Low Back	25 - 30 lbs
Jima Chair, Four-Star Swivel Base, High Back	29 - 34 lbs
Jima Chair, Five-Star Task Base, Low Back	30 - 35 lbs
Jima Chair, Five-Star Task Base, High Back,	35 - 39 lbs

COM/COL material requirement

Yardage is based on a non-patterned fabric. Additional yardage may be required for pattern repeats and the matching required. Leather yield may be affected by the quality of the COL. However, variance in the size of the hides will not affect the yield.

SINGLE UPHOLSTERY	COM [yards]	COL [sq. ft.]
Low Back	2	36
High Back	2 3/4	49 1/2

ARJA jima chair, four leg base

Product Options

Back Height	Seat Upholstery Finish	Glides	Base Finish
L Low Back	Fabric	G Glides, No Felt	C6 Chrome
H High Back	Leather	F Felt Glides	Fundamental Paint Fashion Paint

Note For Felt Glides, add \$35
 For Chrome, add \$0
 For Fundamental Paint Finish, add \$29
 For Fashion Paint Finish, add \$64



Low Back
High Back

Price

COM	COL	Gr.1	Gr.2	Gr.3	Gr.4	Gr.5	Gr.6	Gr.7	Gr.8	Gr.9	Gr.10	Gr.11
1505	1595	1597	1639	1675	1716	1747	1772	1798	1829	1861	1891	1927
1687	1788	1814	1871	1921	1978	2020	2056	2090	2133	2176	2218	2268



Low Back
High Back

Leather

Gr.12	Gr.13	Gr.14	Gr.15	Gr.16	Gr.17	Gr.18	Gr.19	Gr.20	LB	LC	LD
1969	2020	2072	2123	2175	2226	2278	2329	2381	2152	2430	2523
2325	2395	2466	2537	2608	2680	2750	2821	2892	2553	2936	3064

ARJB jima chair, four-star swivel base

Product Options

Back Height	Seat Upholstery Finish	Glides	Base Finish
L Low Back	Fabric	G Glides, No Felt	C9 Polished Aluminum
H High Back	Leather	F Felt Glides	Fundamental Paint Fashion Paint

Note For Felt Glides, add \$35
 For Fundamental Paint Finish, add \$29
 For Fashion Paint Finish, add \$64



Low Back
High Back

Price

COM	COL	Gr.1	Gr.2	Gr.3	Gr.4	Gr.5	Gr.6	Gr.7	Gr.8	Gr.9	Gr.10	Gr.11
1699	1801	1792	1834	1870	1911	1942	1967	1993	2024	2056	2086	2122
1882	1995	2009	2066	2116	2173	2214	2250	2285	2328	2371	2413	2463



Low Back
High Back

Leather



Gr.12	Gr.13	Gr.14	Gr.15	Gr.16	Gr.17	Gr.18	Gr.19	Gr.20	LB	LC	LD
2163	2214	2267	2318	2370	2421	2473	2524	2576	2358	2637	2729
2520	2590	2661	2732	2803	2874	2945	3016	3087	2761	3144	3271

ARJC jima chair, five-star task base

Product Options

Back Height	Seat Upholstery Finish	Glides	Base Finish
L Low Back	Fabric	C Casters	C9 Polished Aluminum
H High Back	Leather		Fundamental Paint
			Fashion Paint

Note For Fundamental Paint Finish, add \$29
 For Fashion Paint Finish, add \$64

		Price												
		COM	COL	Gr.1	Gr.2	Gr.3	Gr.4	Gr.5	Gr.6	Gr.7	Gr.8	Gr.9	Gr.10	Gr.11
	Low Back	1760	1865	1853	1894	1930	1971	2002	2028	2053	2085	2116	2146	2182
	High Back	1943	2060	2071	2127	2177	2234	2276	2312	2347	2390	2433	2474	2524
		Leather												
	Low Back	Gr.12	Gr.13	Gr.14	Gr.15	Gr.16	Gr.17	Gr.18	Gr.19	Gr.20	LB	LC	LD	
	High Back	2224	2275	2327	2378	2430	2481	2533	2584	2637	2826	2700	2793	
		2581	2652	2723	2793	2864	2936	3007	3077	3148	3209	3336		

kalm by Artifort

features

Kalm is Artifort's large, cozy armchair by French designer Patrick Norguet. It is a sanctuary in its own right, a place to unwind and get comfortable. With Kalm, Patrick Norguet has created an iconic, luxurious and comfortable high-back armchair for your living room or study.

Kalm is not only a beautiful chair that will earn a special place for itself in your space. Several Kalm armchairs grouped together will define a hotel lobby or meeting room and create a distinguished and iconic image.



dimensions

- Designed and tested for users up to 110kg/242 lbs
- Meets standard European NEN-16139 requirements

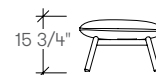
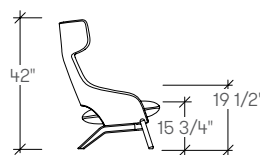
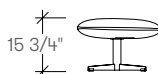
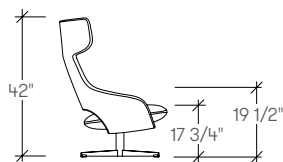
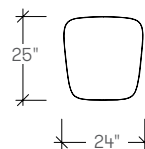
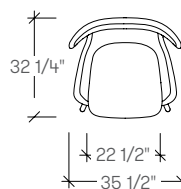
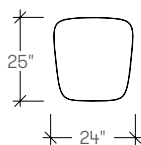
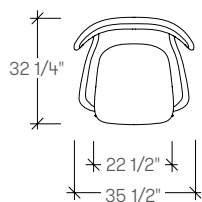

Kalm Lounge Chair,
Four-Star Swivel
(ARKA)

Kalm Footstool,
Four-Star
(ARKB)

Kalm Lounge Chair,
Wood Four Leg
(ARKD)

Kalm Footstool,
Wood Four Leg
(ARKE)

kalm by Artifort

planning

A variety of configurations can be achieved with Kalm Lounge, allowing for various configurations. The following typical demonstrate the versatility that can be achieved.

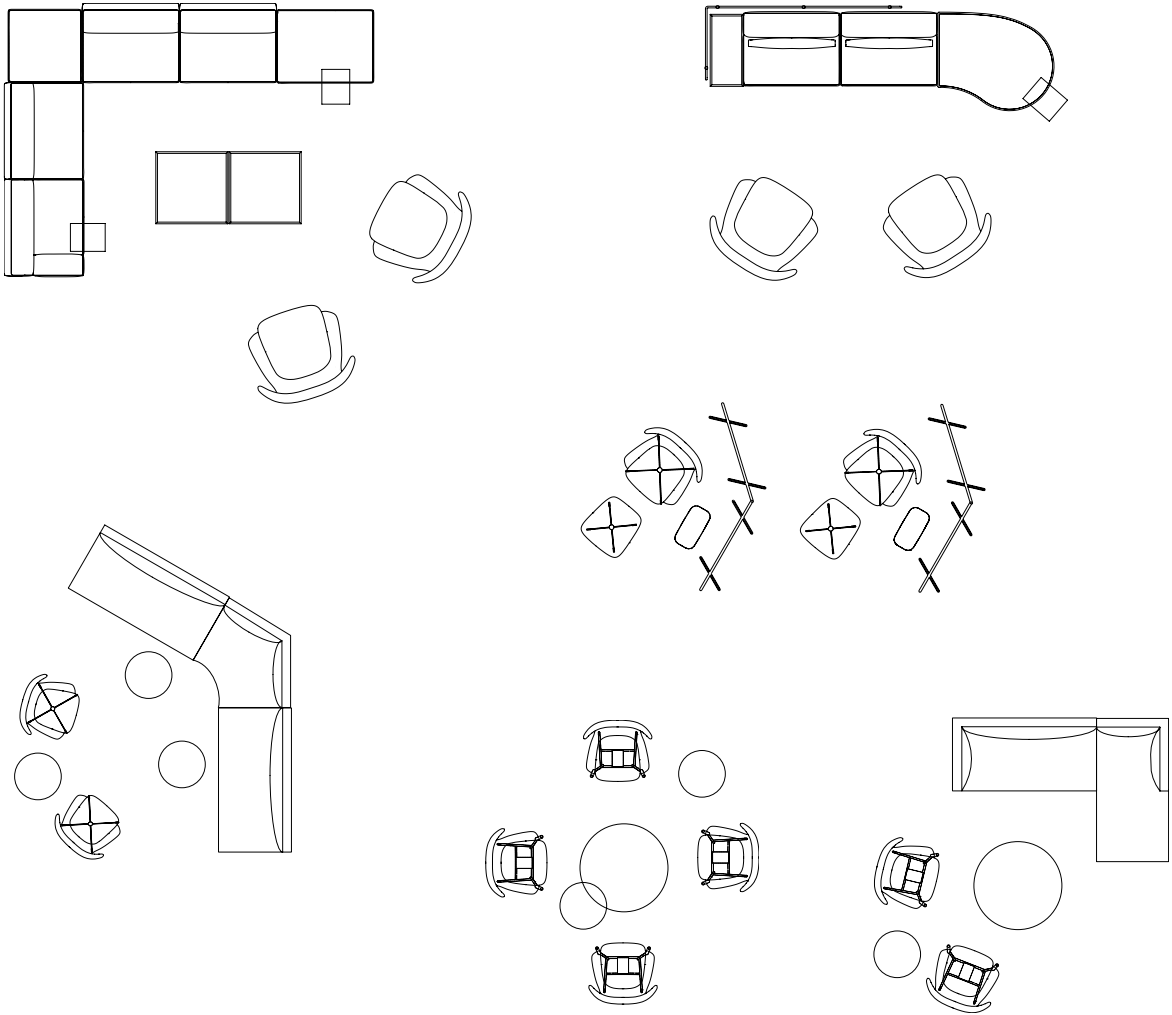

specifying kalm finishes

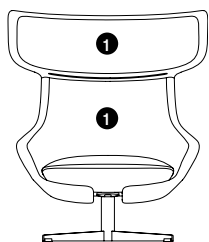

- 1 Seat Upholstery**
Select the seat upholstery

specification example

ARKA Kalm Lounge Chair, Four-Star Swivel	
1 Seat fabric Gr.5	4546
Total:	\$4546

ARKB Kalm Footstool, Four-Star	
1 Seat fabric Gr.5	2405
Total:	\$2405

ARKD Kalm Lounge Chair, Wood Leg	
1 Seat fabric Gr.9	4830
Total:	\$4830

ARKE Kalm Footstool, Wood Leg	
1 Seat fabric Gr.9	2518
Total:	\$2518

weights

Kalm Lounge Chair, Four-Star Swivel	67 - 72 lbs
Kalm Footstool, Four-Star	33 - 38 lbs
Kalm Lounge Chair, Wood Four Leg	60 - 65 lbs
Kalm Footstool, Wood Four Leg	26 - 31 lbs

COM/COL material requirement

Yardage is based on a non-patterned fabric. Additional yardage may be required for pattern repeats and the matching required. Leather yield may be affected by the quality of the COL. However, variance in the size of the hides will not affect the yield.

SINGLE UPHOLSTERY	COM [yards]	COL [sq. ft.]
Kalm	5	90
Kalm Ottoman	2	36

ARKD kalm lounge chair, wood four leg

Product Options

Seat Upholstery Finish		Wood Base Finish	
Fabric		BU	Basque White Oak
Leather		NK	Natural Oak
		DY	Cocoa Brown
		DV	Sierra
		DZ	Truffle



Price

COM	COL	Gr.1	Gr.2	Gr.3	Gr.4	Gr.5	Gr.6	Gr.7	Gr.8	Gr.9	Gr.10	Gr.11
3941	4177	4173	4276	4366	4469	4546	4611	4675	4753	4830	4907	4997
										Leather		
										LB	LC	LD
										5569	6265	6497

ARKE kalm footstool, wood four leg

Product Options

Seat Upholstery Finish		Wood Base Finish	
Fabric		BU	Basque White Oak
Leather		NK	Natural Oak
		DY	Cocoa Brown
		DV	Sierra
		DZ	Truffle



Price

COM	COL	Gr.1	Gr.2	Gr.3	Gr.4	Gr.5	Gr.6	Gr.7	Gr.8	Gr.9	Gr.10	Gr.11
2162	2292	2255	2297	2333	2373	2405	2430	2456	2487	2518	2549	2584
										Leather		
										LB	LC	LD
										2849	3127	3220

kes

features

In partnership with Vondom – a leading Spanish provider of furniture for modern indoor and outdoor commercial spaces – Studio TK is offering Kes seating in North America.

Designed by Gabriele + Oscar Buratti, Kes is a simple chair and armchair. The collection of seating is perfectly suited for transitional indoor and outdoor spaces allowing for use in the indoor café as well as the outdoor patio. Kes is a versatile complement to Studio TK's existing tables collections and Vondom's outdoor table solutions.

Formed from injected polypropylene with fiberglass, Kes is stackable and available in several colors.

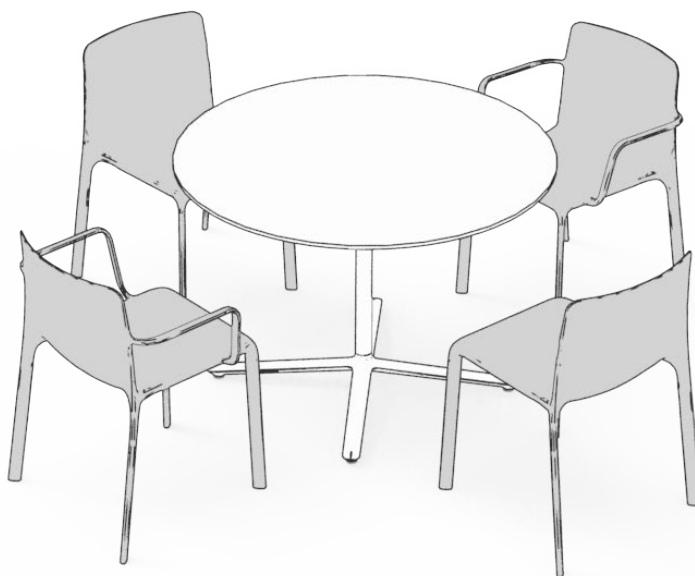

dimensions

- Designed and tested for users up to 300 lbs
- Meets ANSI/BIFMA requirements

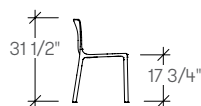
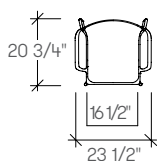
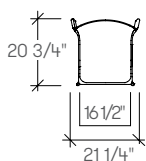

Kes Chair, Armless
(VMKSA)

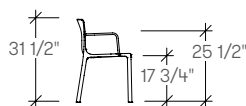

Kes Chair, Arm
(VMKSB)

weights

Kes Chair, Armless	10 - 12 lbs
Kes Chair, Arm	10 - 12 lbs

kes

planning

A variety of configurations can be achieved with Kes, allowing for various configurations. The following typical demonstrate the versatility that can be achieved.

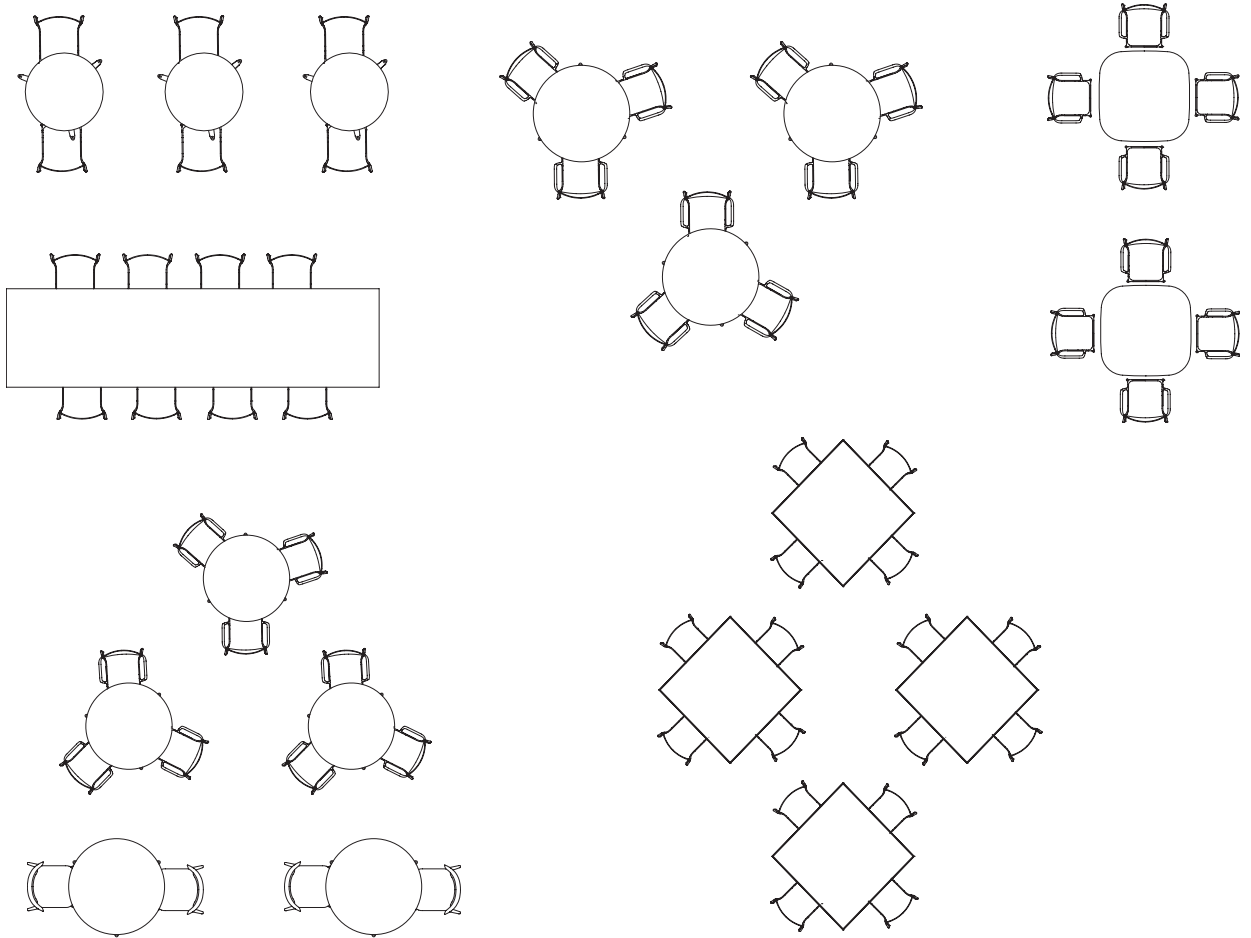

VMKS kes chair

Product Options

Style A Armless Chair B Arm Chair	Vondom Plastic C1 White C2 Ecrú C3 Black
--	--

Note Chairs stack six units high



- A Armless Chair
- B Arm Chair

Price
273
290



kuskoa bi by Alki

features

Kuskoa Bi is a statement piece you can sit on. The rugged shell can be finished two ways and optionally upholstered in total or embellished with just an upholstered seat pad. The cut out shell provides ample back and arm support for long stretches of work. Two desk versions offer supreme mobility, available with a four-star swivel and five-star caster in two powdercoat finishes. The guest chair sits firmly on a solid oak trestle available in five finishes. Perfect for collaboration and conference room scenarios.



dimensions

Kuskoa Bi Desk Chair

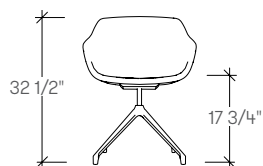

Four-Star Swivel
(ALKDA)

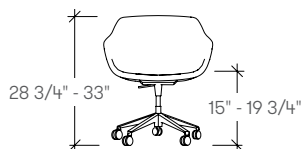

Five-Star Task
(ALKDB)

Kuskoa Bi Chair, Wood Four Leg

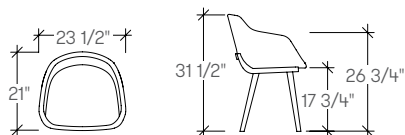

(ALKB)

kuskoa bi by Alki

planning

A variety of configurations can be achieved with Kuskoa Bi, allowing for various configurations. The following typical demonstrate the versatility that can be achieved.

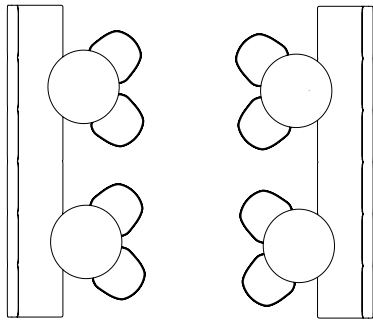

Kuskoa Bi Wood Base

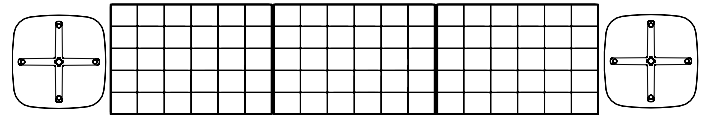

Kuskoa Bi Wood Base

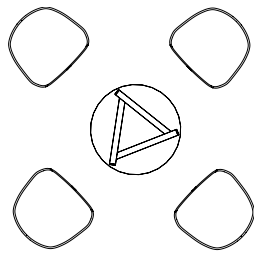
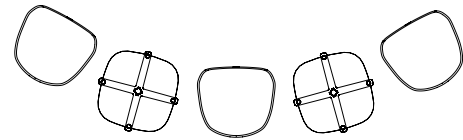

Kuskoa Bi Wood Base

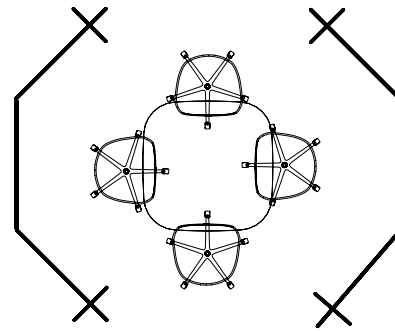

Kuskoa Bi Five-Star Base

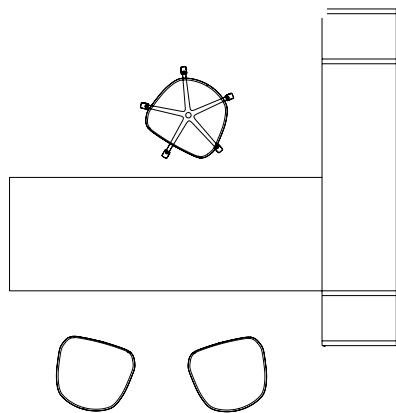

Kuskoa Bi Five-Star Base

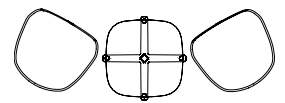
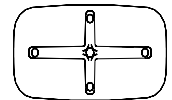
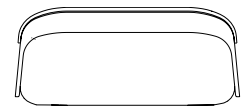

Kuskoa Bi Wood Base

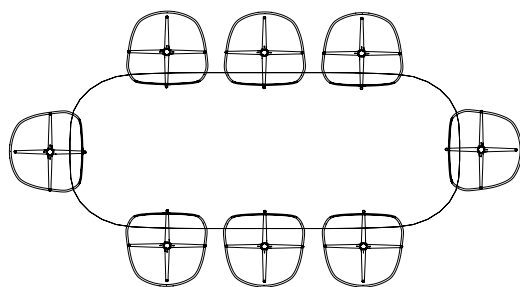

Kuskoa Bi Four-Star Base

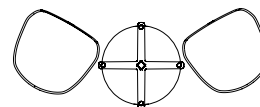
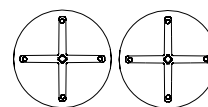
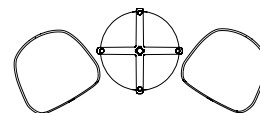

Kuskoa Bi Wood Base

specifying kuskooa bi finishes

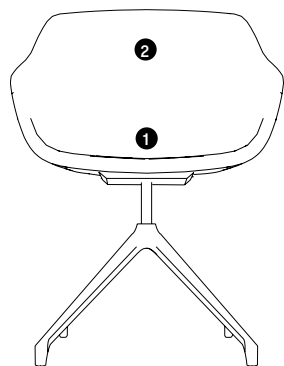

Kuskooa Bi offers three upholstery styles: No Upholstery, Seat Pad Upholstery and Full Upholstery.

- 1 Seat Pad Upholstery**
Select the seat upholstery
- 2 Full Upholstery**
Select the entire seat and back upholstery

specification example

ALKBF Kuskooa Bi Chair, Wood Leg, Fully Upholstered	
1 Seat Pad Fabric Gr.5	2213
Total:	\$2067

ALKDAF Kuskooa Bi Desk Chair, Four-Star Swivel, Fully Upholstered	
1 Seat Pad Fabric Gr.5	2078
Total:	\$2078

weights

Kuskooa Bi Chair, Wood Leg	13 - 18 lbs
Kuskooa Bi Desk Chair, Four-Star Swivel	33 - 38 lbs
Kuskooa Bi Desk Chair, Five-Star Task	33 - 38 lbs

COM/COL material requirement

Yardage is based on a non-patterned fabric. Additional yardage may be required for pattern repeats and the matching required. Leather yield may be affected by the quality of the COL. However, variance in the size of the hides will not affect the yield.

SINGLE UPHOLSTERY		COM [yards]	COL [sq. ft.]
Kuskooa Bi Desk Chair	Seat Pad only	1 1/4	22 1/2
	Full Upholstery	2 1/4	40 1/2
Kuskooa Bi Chair, Wood Leg	Seat Pad only	1 1/4	22 1/2
	Full Upholstery	2 1/4	40 1/2

ALKB kuskoo bi chair, wood four leg

Product Options

Upholstery Style	Upholstery Finish	Plastic Shell Finish	Wood Frame Finish
N No Upholstery	Fabric	JU Sand	BU Basque White Oak
S Upholstered Seat Only	Leather	JZ Clay	NK Natural Oak
F Fully Upholstered			DY Cocoa Brown
			DV Sierra
			DZ Truffle

Note Plastic Shell finish is not available for fully upholstered unit



	Price												
	COM	COL	Gr.1	Gr.2	Gr.3	Gr.4	Gr.5	Gr.6	Gr.7	Gr.8	Gr.9	Gr.10	Gr.11
N No Upholstery	1458												
	Upholstery Finish												
S Upholstered Seat Only	1798	1978	1856	1882	1905	1930	1950	1965	1981	2001	2021	2039	2062
F Fully Upholstered	1941	2134	2045	2091	2132	2178	2213	2242	2271	2306	2341	2376	2416
	Gr.12	Gr.13	Gr.14	Gr.15	Gr.16	Gr.17	Gr.18	Gr.19	Gr.20	Leather			
S Upholstered Seat Only	2088	2120	2153	2184	2217	2249	2282	2313	2346	LB	LC	LD	
F Fully Upholstered	2463	2521	2579	2637	2695	2753	2811	2869	2927	2761	3074	3178	

ALKD kuskoo bi desk chair

Product Options

Style	Upholstery Style	Upholstery Finish	Plastic Shell Finish	Metal Frame Finish
A Four-Star Swivel	N No Upholstery	Fabric	JU Sand	83 Very White
B Five-Star Task	S Upholstered Seat Only	Leather	JZ Clay	52 Ebony
	F Fully Upholstered			

Note Plastic Shell finish is not available for fully upholstered unit
Swivel is not auto-return to center



		Four-Star Swivel Price												
N No Upholstery		1322												
		Upholstery Finish												
		COM	COL	Gr.1	Gr.2	Gr.3	Gr.4	Gr.5	Gr.6	Gr.7	Gr.8	Gr.9	Gr.10	Gr.11
S Upholstered Seat Only		1662	1828	1720	1746	1769	1795	1814	1829	1846	1865	1885	1904	1927
F Fully Upholstered		1805	1986	1909	1956	1996	2043	2078	2107	2136	2170	2205	2240	2281
		Gr.12	Gr.13	Gr.14	Gr.15	Gr.16	Gr.17	Gr.18	Gr.19	Gr.20	Leather			
											LB	LC	LD	
S Upholstered Seat Only		1952	1985	2017	2049	2081	2114	2146	2177	2210		2176	2350	2408
F Fully Upholstered		2327	2385	2443	2501	2559	2617	2675	2733	2791		2612	2926	3030



		Five-Star Task Price												
N No Upholstery		1349												
		Upholstery Finish												
		COM	COL	Gr.1	Gr.2	Gr.3	Gr.4	Gr.5	Gr.6	Gr.7	Gr.8	Gr.9	Gr.10	Gr.11
S Upholstered Seat Only		1688	1857	1746	1771	1795	1820	1840	1855	1871	1891	1911	1929	1952
F Fully Upholstered		1833	2016	1937	1984	2024	2071	2105	2134	2163	2198	2233	2268	2308
		Gr.12	Gr.13	Gr.14	Gr.15	Gr.16	Gr.17	Gr.18	Gr.19	Gr.20	Leather			
											LB	LC	LD	
S Upholstered Seat Only		1978	2010	2043	2074	2107	2139	2172	2203	2235		2205	2379	2437
F Fully Upholstered		2355	2413	2471	2529	2587	2645	2703	2761	2819		2642	2956	3060

kuskoa by Alki

features

Kuskoa is rethinking the role of form and materiality in the new workplace. From large cafes to small collaboration zones, the chair, counter and bar-height stools offer versatile elegance to pair with a range of table types. The stools provide a mid-back support for longer gatherings and a metal foot rest to encourage good posture. A range of material options and finishes provides a variety of ways to express your space. The veneer shell nestles within a solid oak base, which can be finished five ways. Material accents can complement the warmth of the wood with optional inner and outer seat upholstery.



dimensions

Kuskoa Stool

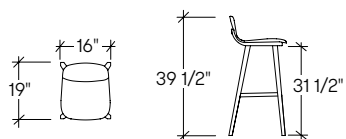

Bar Stool
[ALKSB]

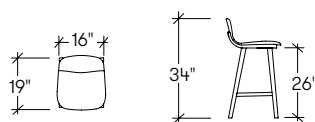

Counter Stool
[ALKSC]

Kuskoa Chair

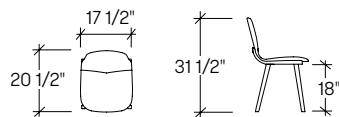

[ALKC]

kuskoa by Alki

planning

A variety of configurations can be achieved with Kuskoa, allowing for various configurations. The following typical demonstrate the versatility that can be achieved.

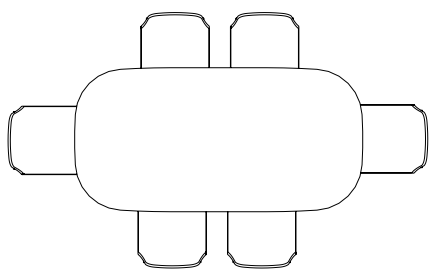
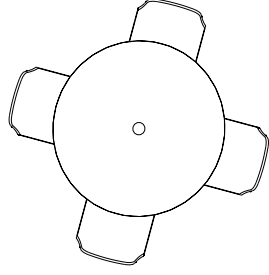
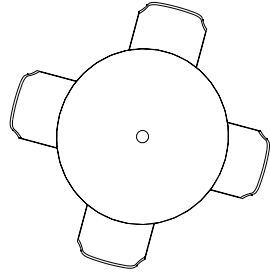
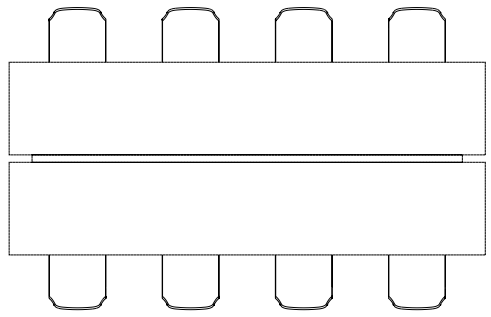
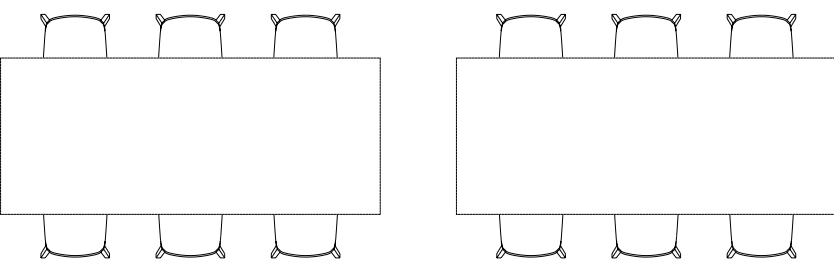
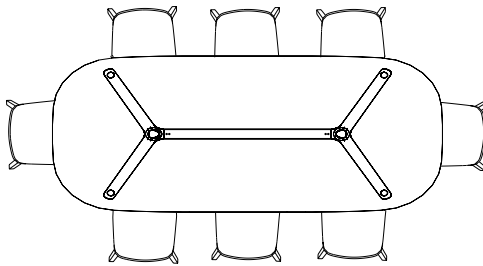

specifying kuskoo finishes

Kuskoo chairs and stools offers three upholstery styles: No Upholstery, Interior Seat and Back Upholstery and Full Upholstery

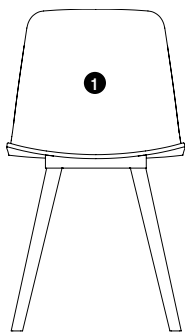

- 1 **Inner Back and Seat Upholstery**
Select the inner back and seat upholstery

specification example

ALKCF Kuskoo Chair, Fully Upholstery	
1 Upholstery Finish Gr.5	2199
Total:	\$2199

ALKSBE Kuskoo Stool, Bar Stool, Upholstered Interior Seat and Back	
1 Upholstery Finish Gr.5	2384
Total:	\$2384

weights

Kuskoo, Chair	11 - 16 lbs
Kuskoo, Bar Stool	13 - 18 lbs
Kuskoo, Counter Stool	13 - 18 lbs

COM/COL material requirement

Yardage is based on a non-patterned fabric. Additional yardage may be required for pattern repeats and the matching required. Leather yield may be affected by the quality of the COL. However, variance in the size of the hides will not affect the yield.

SINGLE UPHOLSTERY

		COM [yards]	COL [sq. ft.]
Kuskoo Chair	Inner Back & Seat	1 3/4	31 1/2
	Full Upholstery	2 3/4	49 1/2
Kuskoo Stool	Inner Back & Seat	1 1/4	22 1/2
	Full Upholstery	2 1/4	20 1/2

ALKC kuskoo chair, wood four leg

Product Options

Upholstery Style	Upholstery Finish	Wood Frame Finish
N No Upholstery	Fabric	BU Basque White Oak
E Upholstered Interior Seat and Back	Leather	NK Natural Oak
F Fully Upholstered		DY Cocoa Brown
		DV Sierra
		DZ Truffle



	Price		Upholstery Finish												
	COM	COL	Gr.1	Gr.2	Gr.3	Gr.4	Gr.5	Gr.6	Gr.7	Gr.8	Gr.9	Gr.10	Gr.11		
N No Upholstery	1458														
E Upholstered Interior Seat and Back	1730	1902	1811	1847	1878	1914	1942	1964	1987	2014	2040	2068	2100		
F Fully Upholstered	1866	2053	1994	2051	2101	2158	2199	2235	2270	2313	2356	2398	2448		
				Leather											
				Gr.12	Gr.13	Gr.14	Gr.15	Gr.16	Gr.17	Gr.18	Gr.19	Gr.20	LB	LC	LD
E Upholstered Interior Seat and Back	2136	2181	2226	2271	2317	2361	2406	2451	2496				2390	2633	2714
F Fully Upholstered	2504	2575	2646	2717	2787	2859	2930	3001	3072				2819	3202	3329

ALKS kuskoo stool , wood four leg

Product Options

Style	Upholstery Style	Upholstery Finish	Wood Frame Finish
B Bar Stool	N No Upholstery	Fabric	BU Basque White Oak
C Counter Stool	E Upholstered Interior Seat and Back	Leather	NK Natural Oak
	F Fully Upholstered		DY Cocoa Brown
			DV Sierra
			DZ Truffle

Note Bar Stool and Counter Stool styles are the same price



	Price		Upholstery Finish												
	COM	COL	Gr.1	Gr.2	Gr.3	Gr.4	Gr.5	Gr.6	Gr.7	Gr.8	Gr.9	Gr.10	Gr.11		
N No Upholstery	2001														
E Upholstered Interior Seat and Back	2232	2455	2290	2315	2339	2364	2384	2399	2415	2435	2455	2473	2496		
F Fully Upholstered	2347	2581	2451	2497	2538	2584	2619	2648	2677	2712	2747	2782	2822		
				Leather											
				Gr.12	Gr.13	Gr.14	Gr.15	Gr.16	Gr.17	Gr.18	Gr.19	Gr.20	LB	LC	LD
E Upholstered Interior Seat and Back	2522	2554	2587	2618	2651	2683	2716	2747	2779				2803	2977	3035
F Fully Upholstered	2869	2927	2985	3043	3101	3159	3217	3275	3333				3207	3521	3625

lasai by Alki

features

Lasai, a lounge with a calming sensibility and a crafted touch. The low profile, Hans Wegner-inspired recline is ideal for getting comfortable and catching up with colleagues. From the Basque for 'calm', the lounge's visual and tactile cues infuse a sense of balance in today's ephemeral work environment. The single and double seat configurations constructed with a wraparound solid oak structure for a welcoming lifestyle feel for your workplace. The oak frame can be finished five ways to add warmth, while the cushions and outer shell allow for a mix of upholstery finishes that can accentuate a space with a quick blast of color or subdue it with a muted palette.

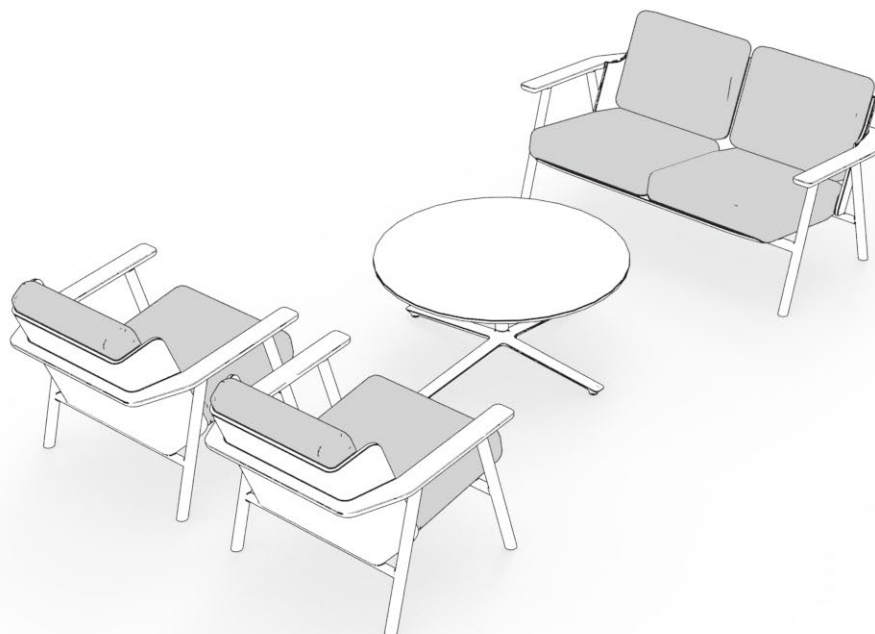

dimensions

Lasai Lounge

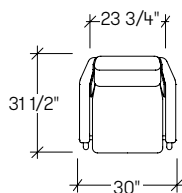

Chair
[ALLCA]

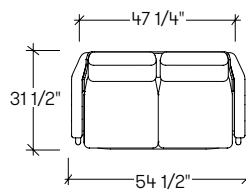
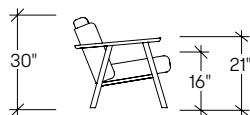

Settee
[ALLCB]

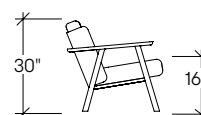

specifying lasai finishes

The modularity of Lasai permits a wide range of fabric combinations that allows for an expressive use of color, texture and material.

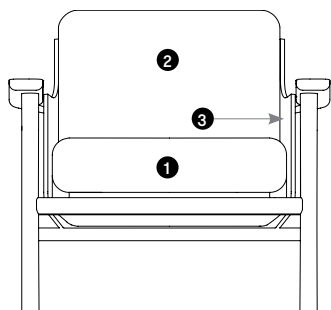

- 1 Seat Upholstery**
Select the seat upholstery
- 2 Back Upholstery**
Select the back upholstery
- 3 Outer Shell Upholstery**
Select the outer shell upholstery

specification example

ALLCA Lasai Lounge Chair	
1 Seat Cushion Gr.5	3865
2 Back Cushion Gr.5	109
3 Outer Back Gr.5	123
Total:	\$4097

ALLCB Lasai Settee	
1 Seat Cushion Gr.3	6752
2 Back Cushion Gr.3	153
3 Outer Back Gr.5	218
Total:	\$7124

weights

Lasai Lounge, Lounge Chair	34 - 39 lbs
Lasai Lounge, Settee	44 - 49 lbs

COM/COL material requirement

Yardage is based on a non-patterned fabric. Additional yardage may be required for pattern repeats and the matching required. Leather yield may be affected by the quality of the COL. However, variance in the size of the hides will not affect the yield.

SINGLE UPHOLSTERY		COM [yards]	COL [sq. ft.]
Lasai Lounge Chair	Seat	2	36
	Back	2	36
	Outer Back	2 1/4	40 1/2
Lasai Settee	Seat	4	72
	Back	4	72
	Outer Back	2 3/4	49 1/2

ALLC lasai lounge

Product Options

Style	Seat Upholstery Finish	Back Upholstery Finish	Outer Shell Upholstery Finish	Wood Frame Finish
A Lounge Chair	Fabric	Fabric	Fabric	BU Basque White Oak
B Settee	Leather	Leather	Leather	NK Natural Oak
				DY Cocoa Brown
				DV Sierra
				DZ Truffle

Seat Upholstery Finish



Style	COM	COL	Gr.1	Gr.2	Gr.3	Gr.4	Gr.5	Gr.6	Gr.7	Gr.8	Gr.9	Gr.10	Gr.11
A Lounge Chair	3623	3985	3715	3757	3793	3834	3865	3891	3916	3947	3979	4009	4045
B Settee	6412	7054	6598	6680	6752	6835	6897	6948	7001	7062	7124	7186	7258

Leather

Style	Gr.12	Gr.13	Gr.14	Gr.15	Gr.16	Gr.17	Gr.18	Gr.19	Gr.20	LB	LC	LD
A Lounge Chair	4087	4138	4190	4241	4293	4344	4396	4447	4500	4541	4820	4913
B Settee	7340	7444	7547	7650	7753	7856	7959	8062	8165	8168	8724	8910

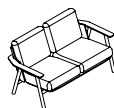

Back Upholstery Finish

Style	COM	COL	Gr.1	Gr.2	Gr.3	Gr.4	Gr.5	Gr.6	Gr.7	Gr.8	Gr.9	Gr.10	Gr.11
A Lounge Chair	0	116	42	60	77	95	109	121	132	146	160	174	190
B Settee	0	116	84	121	153	190	218	241	264	292	320	348	380

Leather

Style	Gr.12	Gr.13	Gr.14	Gr.15	Gr.16	Gr.17	Gr.18	Gr.19	Gr.20	LB	LC	LD
A Lounge Chair	209	232	255	278	302	325	348	371	394	251	376	418
B Settee	418	464	510	557	603	650	696	742	789	501	752	835

Outer Shell Upholstery Finish

Style	COM	COL	Gr.1	Gr.2	Gr.3	Gr.4	Gr.5	Gr.6	Gr.7	Gr.8	Gr.9	Gr.10	Gr.11
A Lounge Chair	0	116	48	68	86	107	123	136	148	165	180	196	215
B Settee	0	116	84	121	153	190	218	241	264	292	320	348	380

Leather

Style	Gr.12	Gr.13	Gr.14	Gr.15	Gr.16	Gr.17	Gr.18	Gr.19	Gr.20	LB	LC	LD
A Lounge Chair	235	261	288	313	340	365	392	418	444	285	428	476
B Settee	418	464	510	557	615	647	679	710	743	501	752	835

libelle

features

Libelle, Dutch for “Dragonfly”, is a functional, yet whimsical, collection of seating options, including: a pouf, a low back lounge chair, and an innovative lounge chair with privacy. Designer Khodi Feiz created Libelle to deliver a personal escape while accommodating small collaborative interactions. An optional tablet arm is a versatile addition that will enhance functionality and can be installed after it’s placed to either the left or right side. The laid back but sophisticated style of Libelle is perfect for today’s flexible work environment.

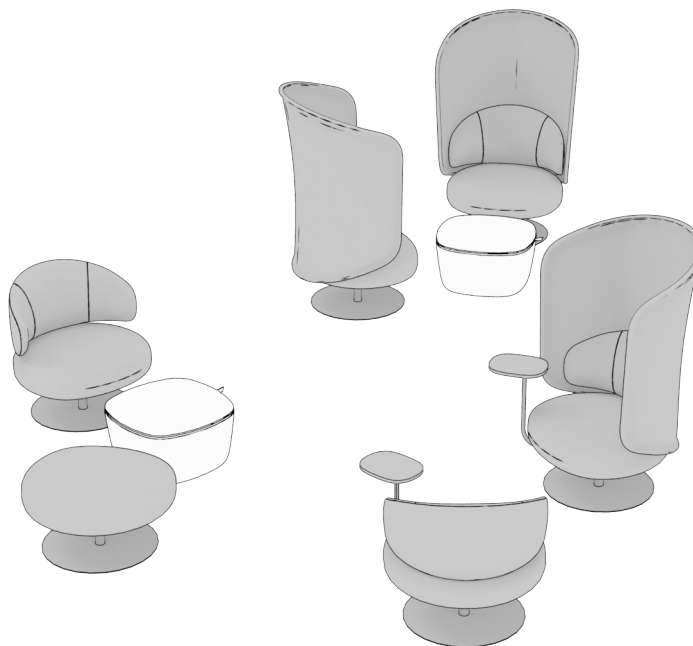

dimensions

- Designed and tested for users up to 300 lbs
- Meets ANSI/BIFMA requirements

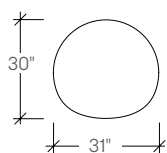

Libelle Lounge, Pouf
(TKBA1)

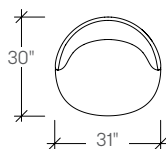

Libelle Lounge, Lounge
(TKBA2)

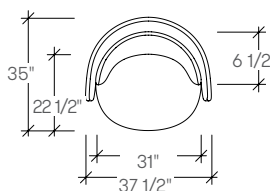

Libelle Lounge, Lounge
with Privacy Screen
(TKBA3)

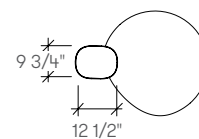

Libelle Tablet
(TKBB)

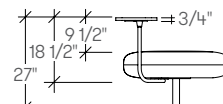
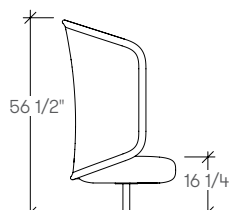
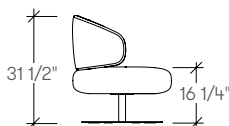
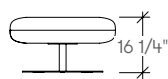

libelle

planning

A variety of configurations can be achieved with Libelle, allowing for various configurations. The following typical demonstrate the versatility that can be achieved.

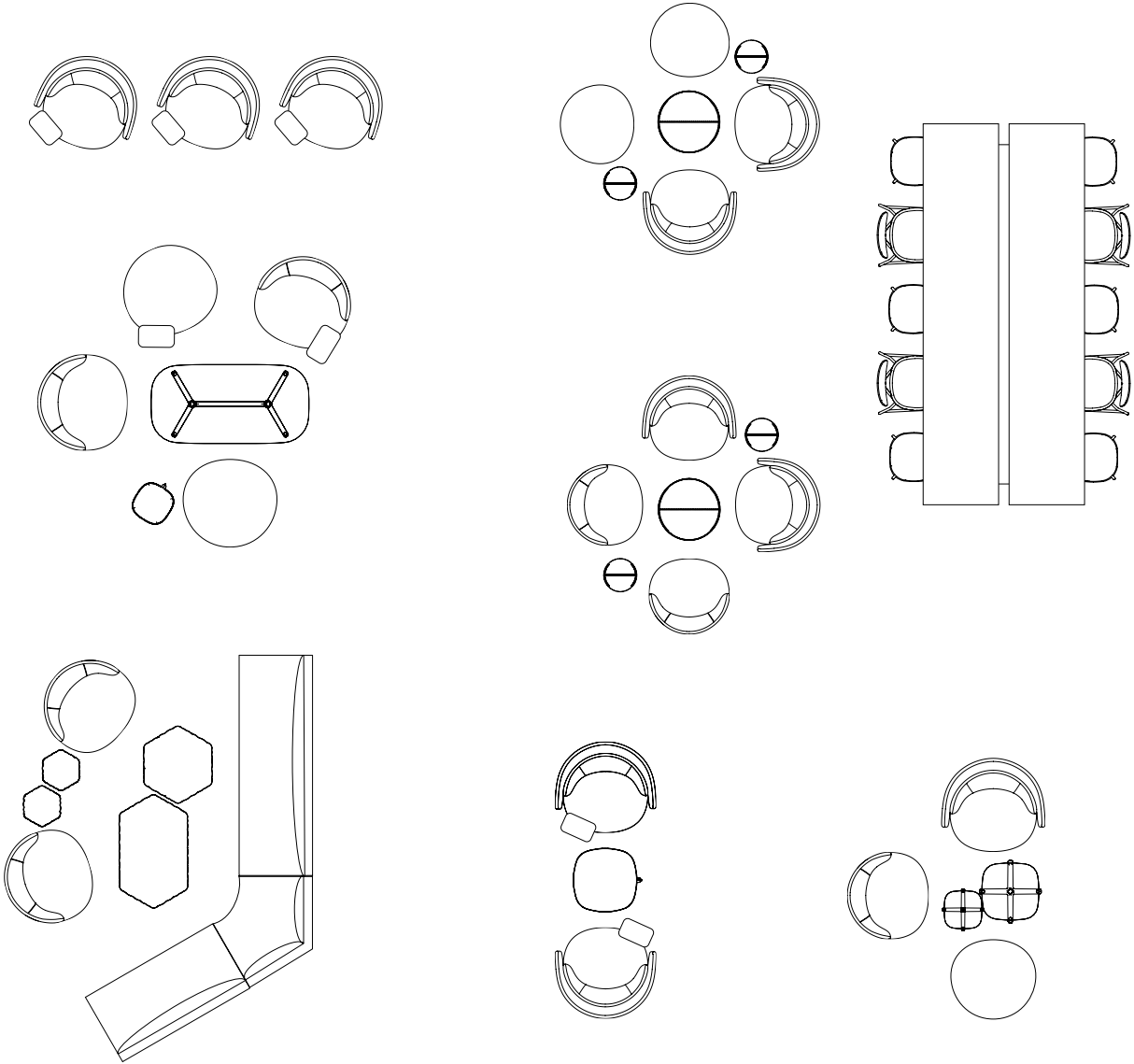

tablet

Libelle Tablet attaches to the Pouf and Lounge Chairs. Chairs have two sets of four holes on the bottom where the tablet arm plate is mounted, for right or left orientation.

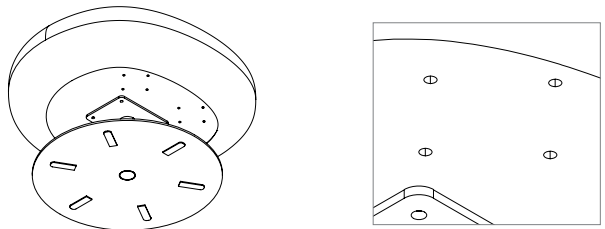

specifying libelle finishes

The modularity of Libelle permits a wide range of fabric combinations that allows for an expressive use of color, texture and material.

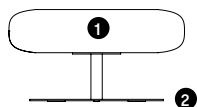

- 1 Seat Upholstery**
Select the seat upholstery
- 2 Select Base Finish**
Select base finish

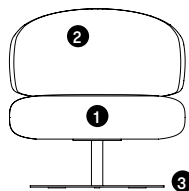

- 1 Seat Upholstery**
Select the seat upholstery
- 2 Bolster Upholstery**
Select the back upholstery
- 3 Select Base Finish**
Select base finish

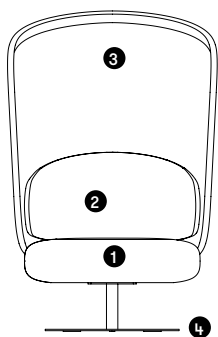

- 1 Seat Upholstery**
Select the seat upholstery
- 2 Bolster Upholstery**
Select the bolster upholstery
- 3 Back Knit**
Select the knit mesh
- 4 Select Base Finish**
Select base finish

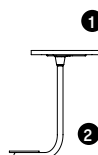

- 1 Top Finish**
Select the top finish
- 2 Frame Finish**
Select the frame finish

specification example

TKBA2 Libelle Lounge, Lounge		
1	Seat fabric Gr.3	2717
2	Back fabric Gr.3	107
3	Base finish, Fundamental	0
Total:		\$2823

TKBA2 Libelle Lounge, Lounge		
1	Seat fabric Gr.5	2789
2	Back fabric Gr.5	152
3	Base finish, Fashion Paint	29
Total:		\$2970

TKBA3 Libelle Lounge, Lounge with Privacy Screen		
1	Seat fabric Gr.5	4065
2	Back fabric Gr.5	152
3	Base finish, Fashion Paint	29
Total:		\$4246

TKBB Libelle Tablet		
1	Surface finish Foundation Laminate	667
2	Arm finish, Fundamental	0
Total:		\$667

weights

Libelle Tablet	5 - 10 lbs
----------------	------------

COM/COL material requirement

Yardage is based on a non-patterned fabric. Additional yardage may be required for pattern repeats and the matching required. Leather yield may be affected by the quality of the COL. However, variance in the size of the hides will not affect the yield.

SINGLE UPHOLSTERY

		COM [yards]	COL [sq. ft.]
Libelle, Pouf	Seat	2	36
Libelle, Lounge	Seat	2	36
	Back	11/4	22 1/2

TKBA libelle lounge

Product Options

Style	Base Style	Seat Upholstery Finish	Back Upholstery Finish	Screen Finish (Privacy Screen Only)	Base Swivel	Base Finish
1 Pouf	A Disc			Knit Mesh	S Swivel	Fundamental Paint
2 Lounge		Fabric	Fabric		N No Swivel	Fashion Paint
3 Lounge with Privacy Screen		Leather	Leather			

Note Swivel version includes an auto return to center swivel mechanism.
 For Fundamental Paint, add \$0
 For Fashion Paint, add \$29

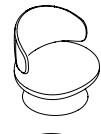
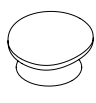

		Seat															
		COM	COL	Gr.1	Gr.2	Gr.3	Gr.4	Gr.5	Gr.6	Gr.7	Gr.8	Gr.9	Gr.10	Gr.11			
1	Pouf	2082	2207	2152	2183	2210	2241	2264	2283	2303	2326	2349	2372	2399			
2	Lounge	2546	2699	2639	2681	2717	2757	2789	2814	2840	2871	2902	2932	2968			
3	Lounge with Privacy Screen	3822	4052	3915	3957	3993	4033	4065	4090	4116	4147	4178	4208	4244			

		Gr.12	Gr.13	Gr.14	Gr.15	Gr.16	Gr.17	Gr.18	Gr.19	Gr.20	Leather		
											LB	LC	LD
1	Pouf	2430	2468	2508	2546	2584	2624	2662	2700	2740	2625	2834	2903
2	Lounge	3010	3061	3113	3164	3217	3268	3320	3371	3423	3256	3535	3627
3	Lounge with Privacy Screen	4286	4337	4389	4440	4493	4544	4596	4647	4699	4609	4887	4980

		Back															
		COM	COL	Gr.1	Gr.2	Gr.3	Gr.4	Gr.5	Gr.6	Gr.7	Gr.8	Gr.9	Gr.10	Gr.11			
1	Pouf	n/a	n/a	n/a	n/a	n/a	n/a	n/a	n/a	n/a	n/a	n/a	n/a	n/a			
2	Lounge	0	116	58	84	107	132	152	167	183	203	223	241	264			
3	Lounge with Privacy Screen	0	116	58	84	107	132	152	167	183	203	223	241	264			

		Gr.12	Gr.13	Gr.14	Gr.15	Gr.16	Gr.17	Gr.18	Gr.19	Gr.20	Leather		
											LB	LC	LD
1	Pouf	n/a	n/a	n/a	n/a	n/a	n/a	n/a	n/a	n/a	n/a	n/a	n/a
2	Lounge	290	322	355	386	419	451	484	515	548	348	522	580
3	Lounge with Privacy Screen	290	322	355	386	419	451	484	515	548	348	522	580

TKBB libelle tablet

Product Options

Surface Finish	Arm Finish
Foundation Laminate	Fundamental Paint
Studio Veneer	Fashion Paint

Note For Fundamental Paint, add \$0
 For Fashion Paint, add \$29
 Tablet Arm can be placed on either right or left side of the lounge or pouf

Price



	Studio Foundation Laminate	Studio Veneer
Tablet	667	667

nina by Artifort

features

Nina a contemporary, mid-century modern design by René Holten. Elegant and comfortable for meeting rooms and dining rooms. The rounded, well-fitted back makes the chair comfortable as active seating or in a more relaxed position.



dimensions

- Designed and tested for users up to 110kg/242 lbs
- Meets standard European NEN-16139 requirements

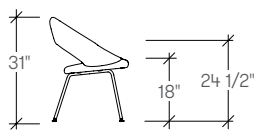
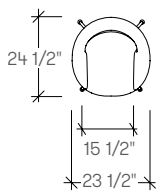

Nina Chair, Four Leg
(ARNA)

nina by Artifort

planning

A variety of configurations can be achieved with Nina, allowing for various configurations. The following typical demonstrate the versatility that can be achieved.

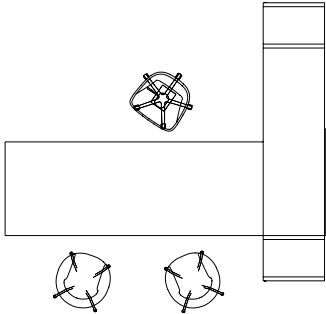
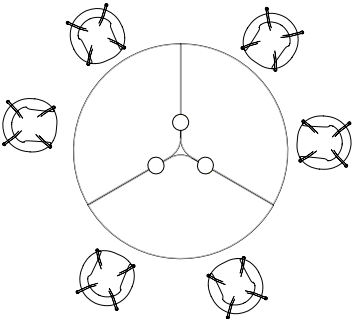
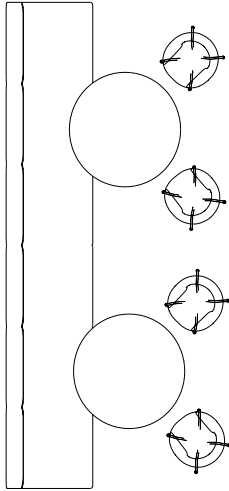
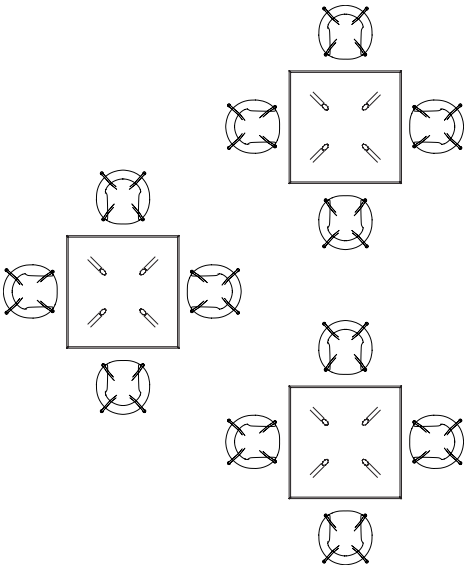
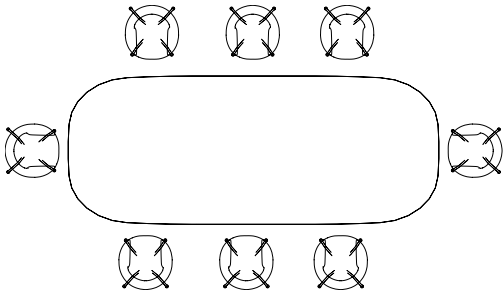
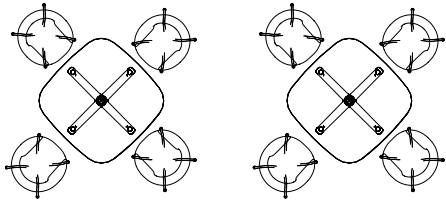

specifying nina finishes

The modularity of Nina permits a wide range of fabric combinations that allows for an expressive use of color, texture and material.

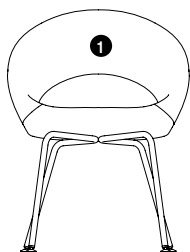

- 1 **Seat Pad Upholstery**
Select the seat upholstery

specification example

ARNA Nina Chair, Four Leg	
1 Seat fabric back Gr.2	1476
Total:	\$1476

ARNA Nina Chair, Four Leg	
1 Seat fabric back Gr.8	1714
Total:	\$1714

weights

Nina Chair, Four Leg	22 - 27 lbs
----------------------	-------------

COM/COL material requirement

Yardage is based on a non-patterned fabric. Additional yardage may be required for pattern repeats and the matching required. Leather yield may be affected by the quality of the COL. However, variance in the size of the hides will not affect the yield.

SINGLE UPHOLSTERY	COM [yards]	COL [sq. ft.]
Nina	2 1/2	45

ARNA nina chair, four leg

Product Options

Seat Upholstery Finish				Base Finish			
Fabric				C6 Chrome			
Leather							



Price

COM	COL	Gr.1	Gr.2	Gr.3	Gr.4	Gr.5	Gr.6	Gr.7	Gr.8	Gr.9	Gr.10	Gr.11
1308	1453	1424	1476	1521	1573	1611	1644	1676	1714	1753	1792	1837
										Leather		
Gr.12	Gr.13	Gr.14	Gr.15	Gr.16	Gr.17	Gr.18	Gr.19	Gr.20		LB	LC	LD
1888	1953	2017	2082	2146	2211	2275	2340	2404		2149	2497	2613

pala by Artifort

features

Pala is a fully upholstered armchair on a pedestal designed by Italian designer Luca Nichetto. The design follows the shape of a human body and combines Artifort's heritage with a contemporary approach. Ideal to create an iconic image and display one's culture.

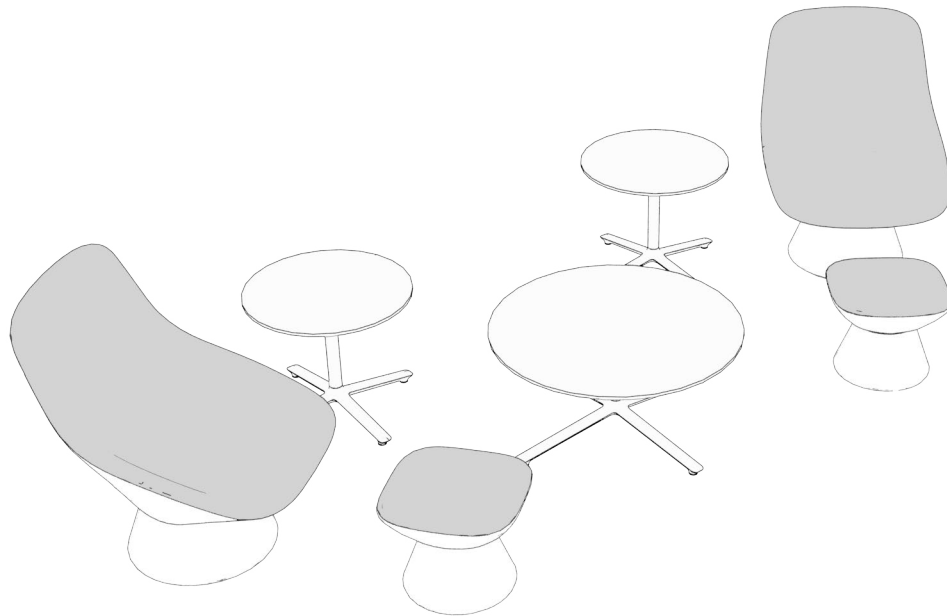

dimensions

- Designed and tested for users up to 110kg/242 lbs
- Meets standard European NEN-16139 requirements

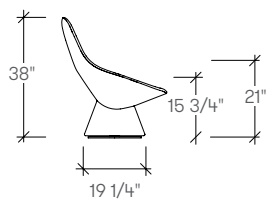
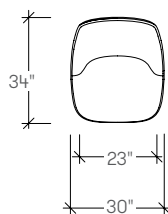

Pala Lounge Chair
(ARPA)

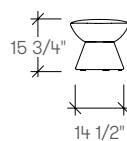
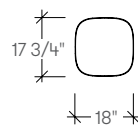

Pala Ottoman
(ARPB)

pala by Artifort**planning**

A variety of configurations can be achieved with Pala, allowing for various configurations. The following typical demonstrate the versatility that can be achieved.

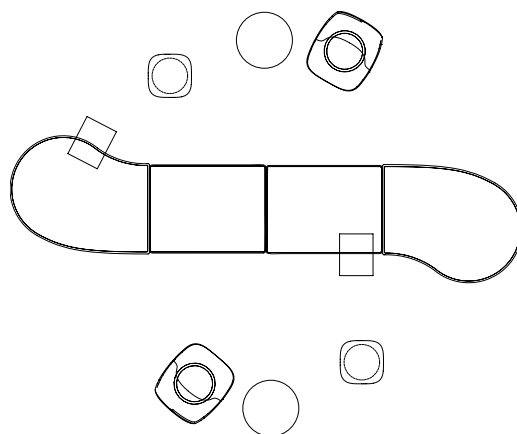
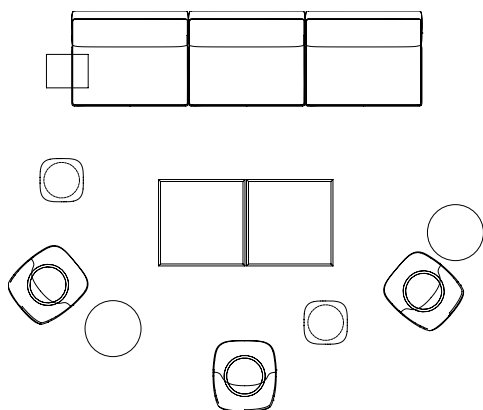
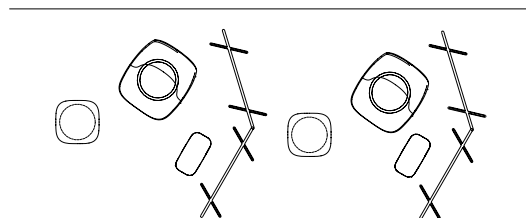
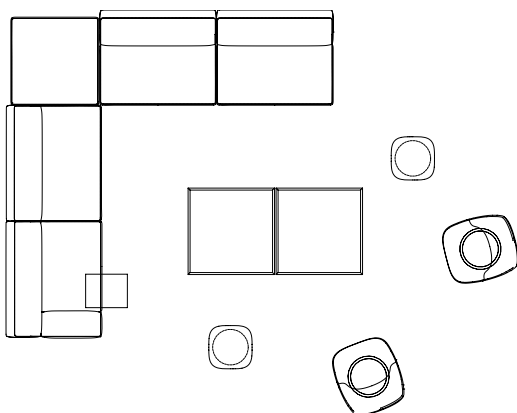
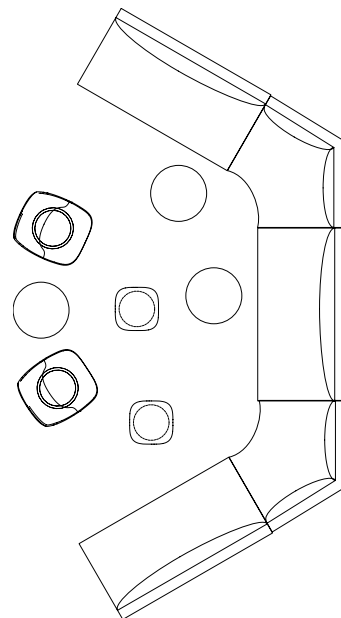
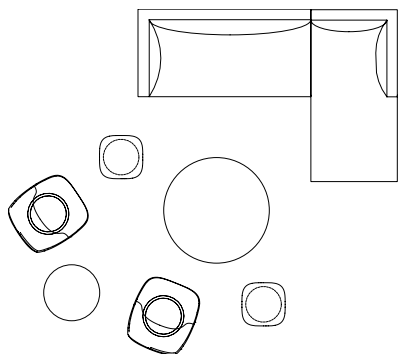

specifying pala finishes

The modularity of Pala permits a wide range of fabric combinations that allows for an expressive use of color, texture and material.

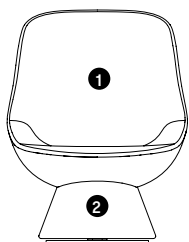

- 1 Inner Seat Upholstery**
Select inner seat upholstery
- 2 Outer Back & Base Upholstery**
Select outer back and base upholstery

specification example

ARPAN	Pala Lounge Chair, Non-Swivel	
1	Seat fabric Gr.2	4087
2	Back fabric Gr.2	335
Total:		\$4422

ARPAN	Pala Lounge Chair, Non-Swivel	
1	Seat fabric Gr.8	4373
2	Back fabric Gr.2	335
Total:		\$4708

ARPAN	Pala Lounge Chair, Non-Swivel	
1	Seat fabric Gr.8	4373
2	Back fabric Gr.16	1675
Total:		\$6048

weights

Pala Lounge Chair	75 - 85 lbs
Pala Ottoman	15 - 20 lbs

COM/COL material requirement

Yardage is based on a non-patterned fabric. Additional yardage may be required for pattern repeats and the matching required. Leather yield may be affected by the quality of the COL. However, variance in the size of the hides will not affect the yield.

SINGLE UPHOLSTERED	COM [yards]	COL [sq. ft.]
Pala - Lounge Interior	3	54
Pala - Lounge Exterior	5	90
Pala - Ottoman Top	11/2	27
Pala - Ottoman Base	2	36

ARPA pala lounge chair

Product Options

Style	Inner Seat and Back Upholstery Finish	Outer Back and Base Upholstery Finish
N No Swivel	Fabric	Fabric
S Swivel	Leather	Leather

Note Swivel is not auto-return to center

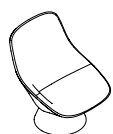

		Seat												
		COM	COL	Gr.1	Gr.2	Gr.3	Gr.4	Gr.5	Gr.6	Gr.7	Gr.8	Gr.9	Gr.10	Gr.11
N	No Swivel	3886	4119	4025	4087	4141	4203	4249	4289	4327	4373	4420	4466	4521
S	Swivel	4019	4261	4159	4220	4275	4336	4382	4422	4460	4507	4553	4599	4654
												Leather		
		Gr.12	Gr.13	Gr.14	Gr.15	Gr.16	Gr.17	Gr.18	Gr.19	Gr.20	LB	LC	LD	
N	No Swivel	4582	4660	4736	4814	4892	4968	5046	5124	5200	4954	5372	5511	
S	Swivel	4715	4793	4870	4947	5025	5102	5179	5257	5334	5096	5513	5653	
		Back and Base												
		COM	COL	Gr.1	Gr.2	Gr.3	Gr.4	Gr.5	Gr.6	Gr.7	Gr.8	Gr.9	Gr.10	Gr.11
N	No Swivel	0	116	232	335	426	529	606	670	734	812	890	966	1057
S	Swivel	0	116	232	335	426	529	606	670	734	812	890	966	1057
												Leather		
		Gr.12	Gr.13	Gr.14	Gr.15	Gr.16	Gr.17	Gr.18	Gr.19	Gr.20	LB	LC	LD	
N	No Swivel	1160	1289	1418	1546	1675	1805	1934	2062	2191	1508	2204	2436	
S	Swivel	1160	1289	1418	1546	1675	1805	1934	2062	2191	1508	2204	2436	

ARPB pala ottoman

Product Options

Seat Top Upholstery Finish	Base Upholstery Finish
Fabric	Fabric
Leather	Leather



		Seat												
		COM	COL	Gr.1	Gr.2	Gr.3	Gr.4	Gr.5	Gr.6	Gr.7	Gr.8	Gr.9	Gr.10	Gr.11
		1321	1400	1391	1422	1449	1480	1503	1522	1542	1565	1588	1611	1638
												Leather		
		Gr.12	Gr.13	Gr.14	Gr.15	Gr.16	Gr.17	Gr.18	Gr.19	Gr.20	LB	LC	LD	
		1669	1708	1747	1785	1824	1863	1901	1940	1979	1818	2027	2096	
		Base												
		COM	COL	Gr.1	Gr.2	Gr.3	Gr.4	Gr.5	Gr.6	Gr.7	Gr.8	Gr.9	Gr.10	Gr.11
		0	116	93	135	171	211	242	268	293	325	356	386	422
												Leather		
		Gr.12	Gr.13	Gr.14	Gr.15	Gr.16	Gr.17	Gr.18	Gr.19	Gr.20	LB	LC	LD	
		464	515	567	618	670	722	774	825	877	673	951	1044	

petal

features

Petal Lounge provokes an essence of nature and mimics the blossoming of a flower with the natural organic curves of the chair. The sense of tranquility Petal brings into a space adds an inviting atmosphere to any room. Designed by the Studio TK Design team as an accent piece in a traditional lounge environment or used in multiples for a stand-alone greeting space, Petal can enhance any space.

Paired with an exposed plywood base or one of the two metal base options in an organic paint color, Petal exudes a natural calm. Petal includes three base styles including an exposed plywood base, an auto-return swivel disc base, and a four-leg metal base.

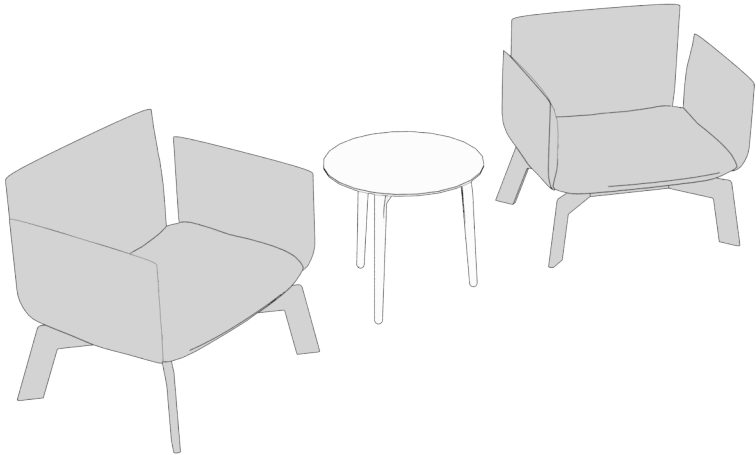

dimensions

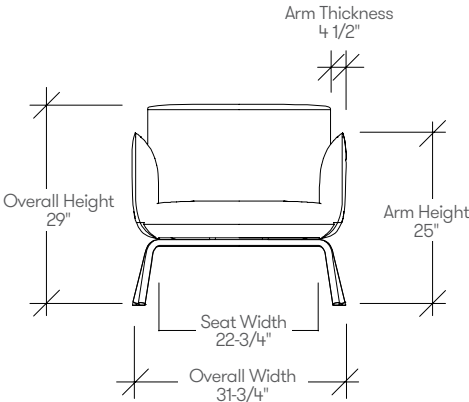

Petal Lounge
(STW1)
front view

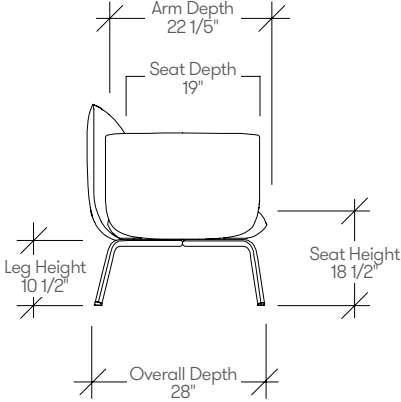

Petal Lounge
(STW1)
side view

petal

planning

A variety of configurations can be achieved with Petal, allowing for various configurations. The following typical demonstrate the versatility that can be achieved.

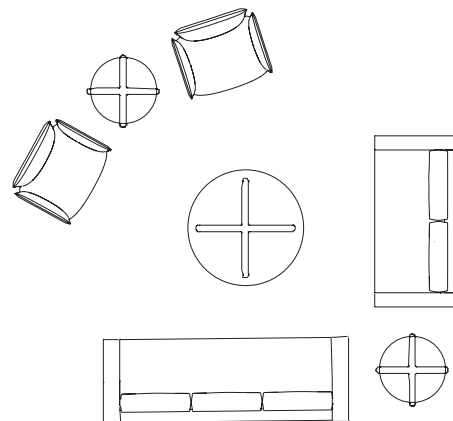
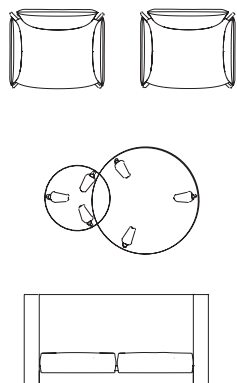
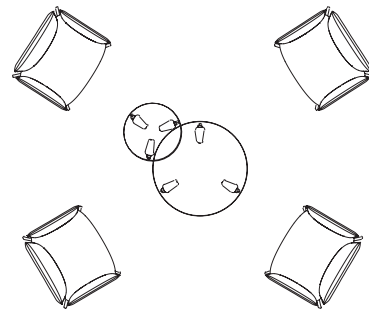
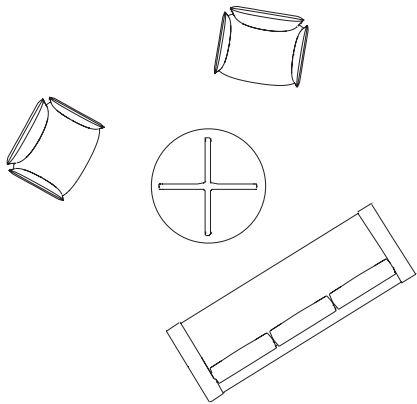
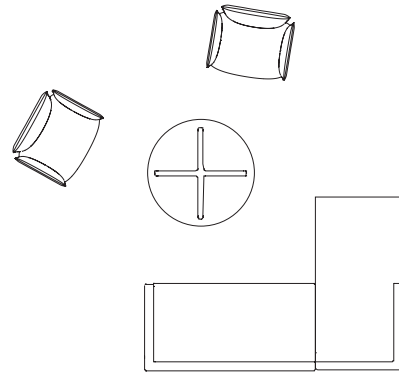
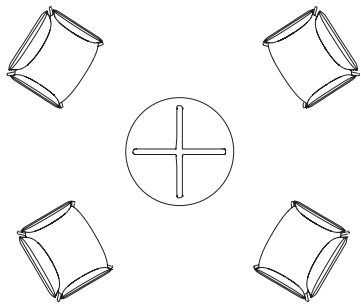

specifying petal finishes

The modularity of Petal permits a wide range of fabric combinations that allows for an expressive use of color, texture and material.

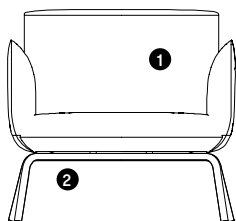

- 1 Seat Upholstery**
Select seat upholstery
- 2 Base Finish**
Select base finish

specification example

	STW1D	Petal Disc	
1	Seat fabric Gr. 2		3047
	Total:		\$3047

	STW1D	Petal Disc	
1	Seat fabric Gr. 8		3405
	Total:		\$3405

	STW1L	Petal 4-Leg	
1	Seat fabric Gr. 2		2926
	Total:		\$2926

	STW1L	Petal 4-Leg	
1	Seat fabric Gr. 8		3341
	Total:		\$3341

	STW1W	Petal Plywood	
1	Seat fabric Gr. 2		3407
	Total:		\$3407

	STW1W	Petal Plywood	
1	Seat fabric Gr. 8		3648
	Total:		\$3648

COM/COL material requirement

Yardage is based on a non-patterned fabric. Additional yardage may be required for pattern repeats and the matching required. Leather yield may be affected by the quality of the COL. However, variance in the size of the hides will not affect the yield.

SINGLE UPHOLSTERED

	COM [yards]	COL [sq. ft.]
Petal Lounge	3-3/4	67-1/2

STW1D petal lounge chair, disc

Product Options

Seat Upholstery	Frame Finish
Fabric	Fundamental Paint
Leather	Fashion Paint

Note For Fashion Paint, add \$29
Includes auto return to center swivel mechanism

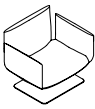

Seat

COM	COL	Gr.1	Gr.2	Gr.3	Gr.4	Gr.5	Gr.6	Gr.7	Gr.8	Gr.9	Gr.10	Gr.11
2796	3075	2970	3047	3115	3192	3250	3298	3347	3405	3463	3521	3588
Gr.12	Gr.13	Gr.14	Gr.15	Gr.16	Gr.17	Gr.18	Gr.19	Gr.20	Leather			
3666	3762	3859	3956	4052	4149	4246	4342	4439	LB	LC	LD	
									4119	4641	4815	

pico

features

Inspired by Mt. Pico, Portugal's highest mountain peak, Studio TK's Pico Lounge is perfectly designed for public spaces, offices, lounges, or collaborative areas. Pico brings a sculptural element to today's workspaces from back to front. To achieve this goal, famed designers Flemming Busk and Stephan Hertzog used folded paper to create the natural shape of Pico. The organic appearance of both the low back and high back versions evoke a sense of comfort, encourage free movement, and open various seating postures. Complementing the free-flowing design, three very distinct bases are available: a 4-star swivel base, metal sled base and wood leg base. As a result, Pico is everything you want from a lounge chair; it is inviting, warm, and welcoming.

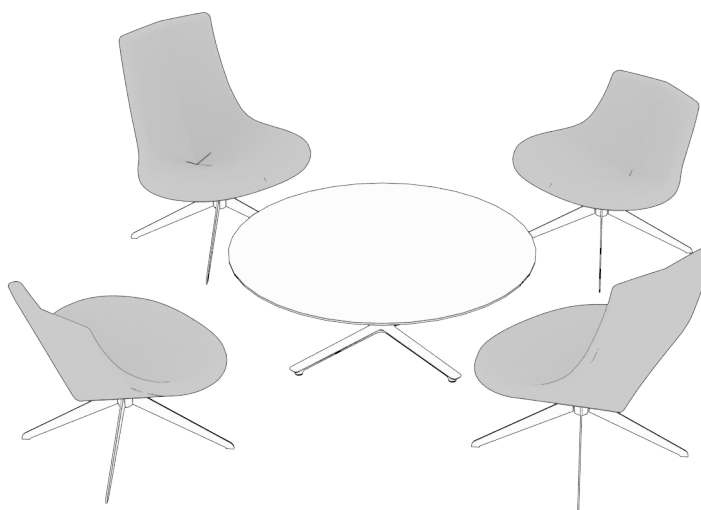

dimensions

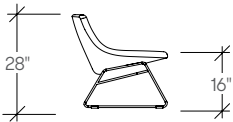
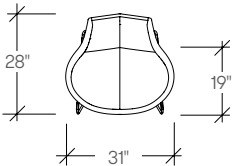

Pico Lounge,
Sled Base, Low Back
(TKCAL)

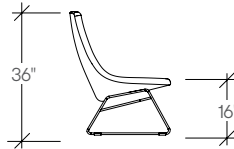
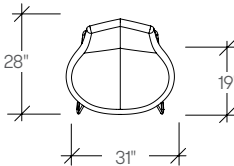

Pico Lounge,
Sled Base, High Back
(TKCAH)

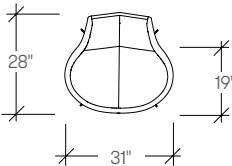

Pico Lounge,
Four Star Swivel,
Low Back
(TKCBL)

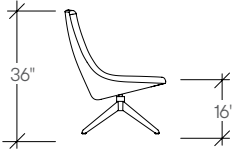
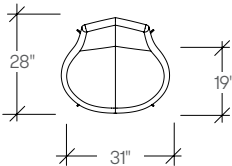

Pico Lounge,
Four Star Swivel,
High Back
(TKCBH)

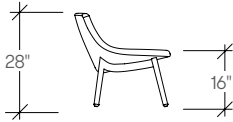
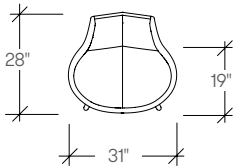

Pico Lounge,
Wood Four Leg, Low Back
(TKCCL)

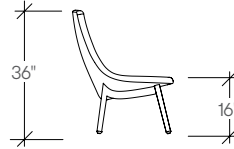
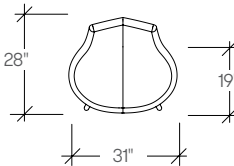

Pico Lounge,
Wood Four Leg, High Back
(TKCCH)

pico

planning

A variety of configurations can be achieved with Pico, allowing for various configurations. The following typical demonstrate the versatility that can be achieved.

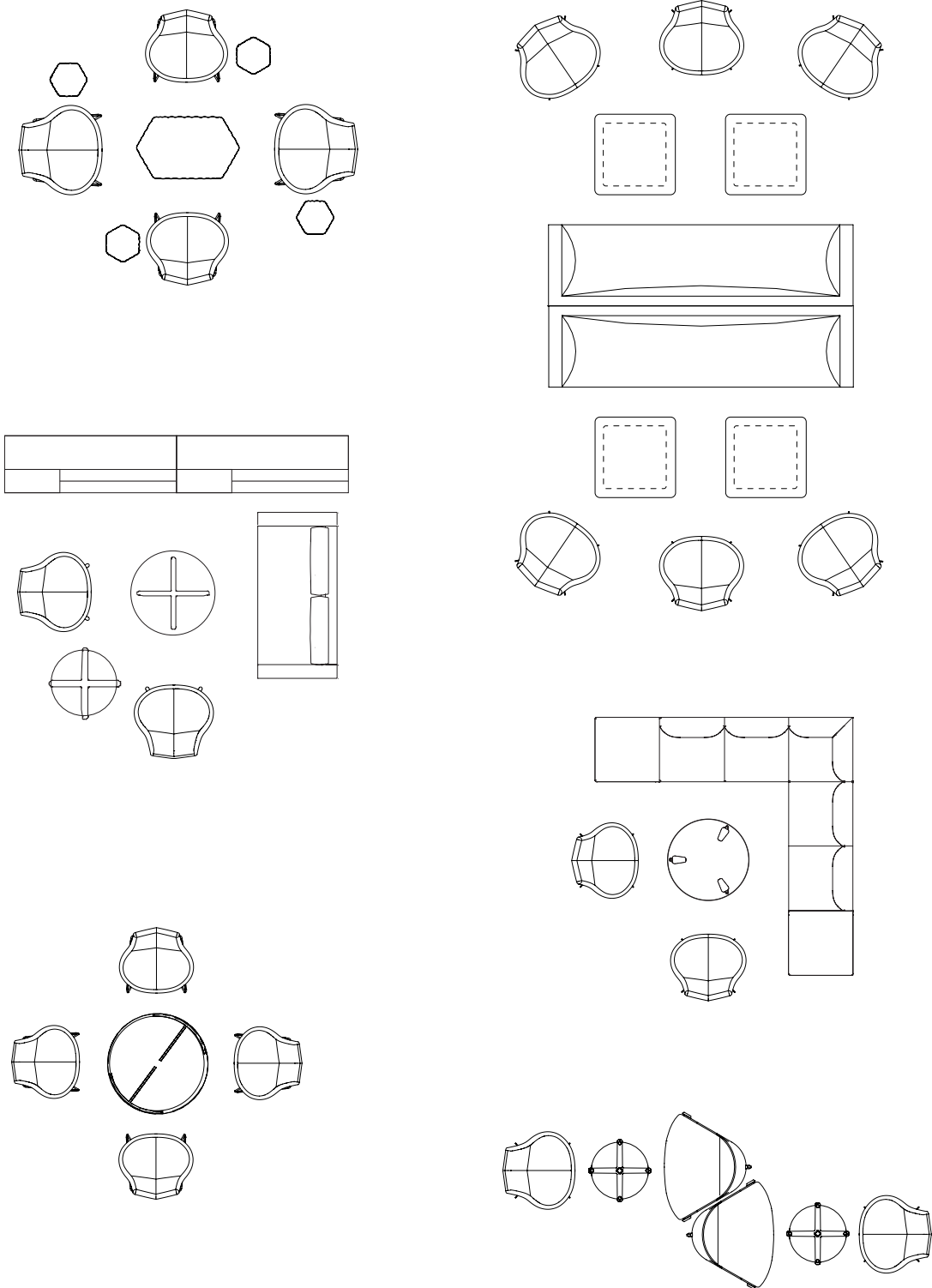

specifying pico finishes

The modularity of Pico permits a wide range of fabric combinations that allows for an expressive use of color, texture and material.

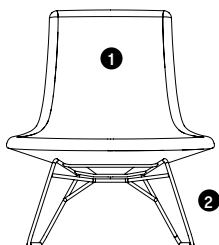

- 1 **Seat Upholstery**
Select seat upholstery
- 2 **Base Finish**
Select base finish

specification example

	TKCAL	Pico, Low Back, Sled Base
1	Seat Fabric Gr. 2	2333
2	Sled Base, Fundamental Paint	0
	Felt Glides	35
	Total:	\$2368

	TKCAL	Pico, Low Back, Sled Base
1	Seat Fabric Gr. 8	2523
2	Sled Base, Fundamental Paint	0
	Felt Glides	35
	Total:	\$2558

	TKCBH	Pico, High Back, Four-Star Swivel
1	Seat Fabric Gr. 2	2678
2	Four-Star Swivel, Fashion Paint	29
	Total:	\$2707

	TKCBH	Pico, High Back, Four-Star Swivel
1	Seat Fabric Gr. 8	2941
2	Four-Star Swivel, Fashion Paint	29
	Total:	\$2970

COM/COL material requirement

Yardage is based on a non-patterned fabric. Additional yardage may be required for pattern repeats and the matching required. Leather yield may be affected by the quality of the COL. However, variance in the size of the hides will not affect the yield.

SINGLE UPHOLSTERED	COM [yards]	COL [sq. ft.]
Low Back	2	36
High Back	2-3/4	49-1/2

TKCA pico lounge, sled base

Product Options

Back Height	Seat Upholstery	Glides	Base Finish
L Low Back	Fabric	G Glides, No Felt	Fundamental Paint
H High Back	Leather	F Felt Glides	Fashion Paint

Note For Fundamental Paint, add \$0
 For Fashion Paint, add \$29
 For Glides, No Felt add \$0
 For Felt Glides add \$35



		Price												
		COM	COL	Gr.1	Gr.2	Gr.3	Gr.4	Gr.5	Gr.6	Gr.7	Gr.8	Gr.9	Gr.10	Gr.11
Low Back	Low Back	2198	2330	2291	2333	2369	2409	2441	2466	2492	2523	2554	2584	2620
	High Back	2262	2398	2390	2446	2496	2553	2595	2631	2666	2709	2752	2793	2843
		Leather												
		Gr.12	Gr.13	Gr.14	Gr.15	Gr.16	Gr.17	Gr.18	Gr.19	Gr.20	LB	LC	LD	
Low Back	Low Back	2662	2713	2765	2816	2869	2920	2972	3023	3075	2887	3166	3258	
	High Back	2900	2971	3042	3112	3183	3255	3326	3396	3467	3163	3546	3674	

TKCB pico lounge, four-star swivel

Product Options

Back Height	Seat Upholstery	Base Finish
L Low Back	Fabric	Fundamental Paint
H High Back	Leather	Fashion Paint

Note For Fundamental Paint, add \$0
 For Fashion Paint, add \$29



		Price												
		COM	COL	Gr.1	Gr.2	Gr.3	Gr.4	Gr.5	Gr.6	Gr.7	Gr.8	Gr.9	Gr.10	Gr.11
Low Back	Low Back	2430	2576	2523	2565	2601	2641	2673	2698	2724	2755	2786	2816	2852
	High Back	2494	2644	2622	2678	2728	2785	2827	2863	2898	2941	2984	3025	3075
		Leather												
		Gr.12	Gr.13	Gr.14	Gr.15	Gr.16	Gr.17	Gr.18	Gr.19	Gr.20	LB	LC	LD	
Low Back	Low Back	2894	2945	2997	3048	3101	3152	3204	3255	3307	3133	3412	3504	
	High Back	3132	3203	3274	3344	3415	3487	3558	3628	3699	3409	3792	3920	

TKCC pico lounge, wood four leg

Product Options

Back Height	Seat Upholstery	Glides	Wood Base Finish
L Low Back	Fabric	G Glides, No Felt	BU Basque White Oak
H High Back	Leather	F Felt Glides	NK Natural Oak
			DY Cocoa Brown
			DV Sierra
			DZ Truffle

Note For Glides, No Felt add \$0
For Felt Glides add \$35



Low Back
High Back

Price

COM	COL	Gr.1	Gr.2	Gr.3	Gr.4	Gr.5	Gr.6	Gr.7	Gr.8	Gr.9	Gr.10	Gr.11
2430	2576	2523	2565	2601	2641	2673	2698	2724	2755	2786	2816	2852
2494	2644	2622	2678	2728	2785	2827	2863	2898	2941	2984	3025	3075



Low Back
High Back

Gr.12	Gr.13	Gr.14	Gr.15	Gr.16	Gr.17	Gr.18	Gr.19	Gr.20
2894	2945	2997	3048	3101	3152	3204	3255	3307
3132	3203	3274	3344	3415	3487	3558	3628	3699

Leather

LB	LC	LD
3133	3412	3504
3409	3792	3920

qui

features

Qui encourages quick touch points and collaborative interaction. A collection of surfaces and seating. Qui is a flexible-use product that offers a multiplicity of deployments in reconfigurable formats. Contrasting textile applications allow for various configurations.

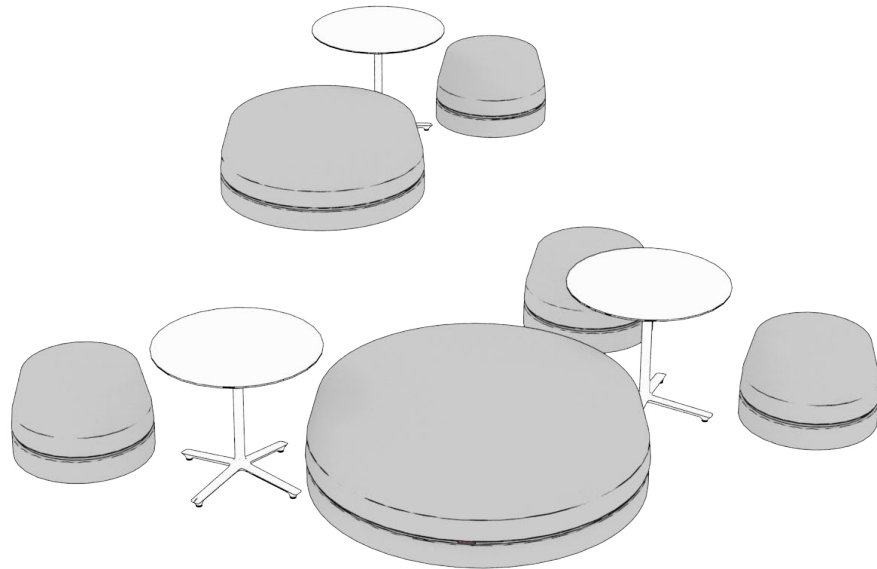

dimensions

- Designed and tested for users up to 300 lbs
- Meets ANSI/BIFMA requirements

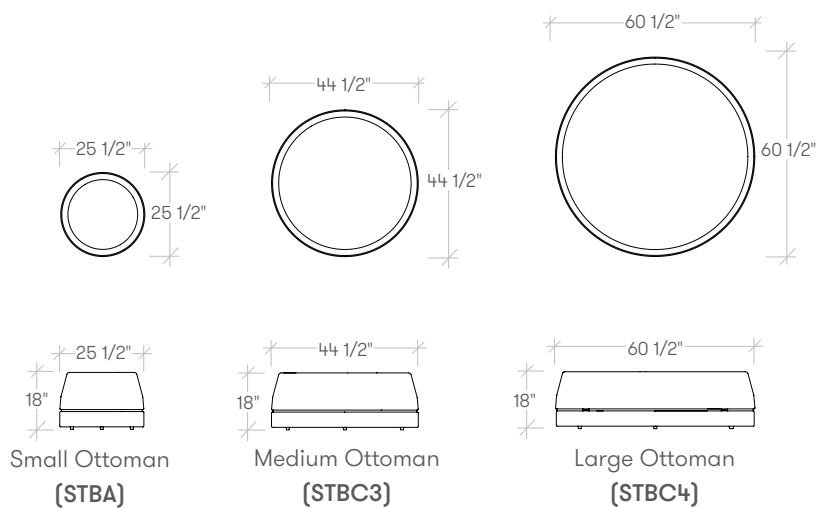

qui

planning

A variety of configurations can be achieved with Qui, allowing for various configurations. The following typical demonstrate the versatility that can be achieved.

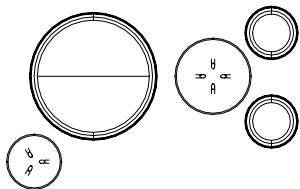
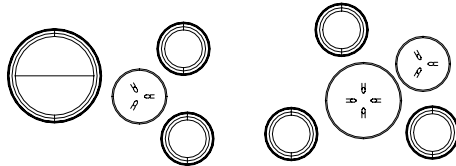
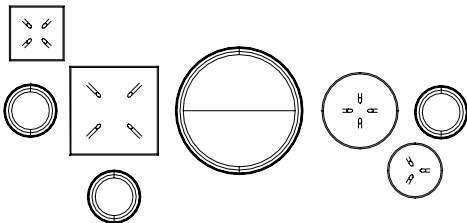
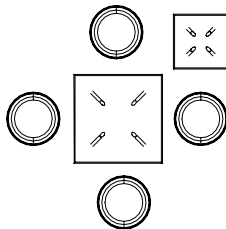
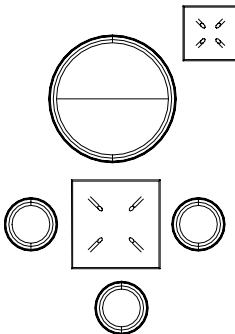
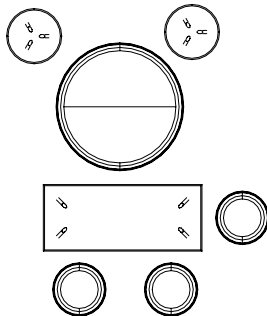
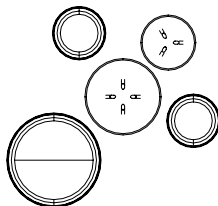
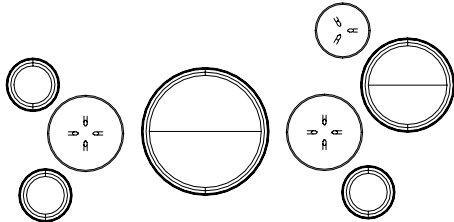
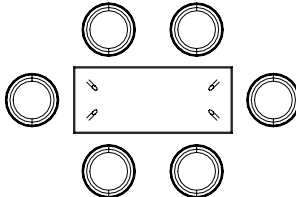

qui

planning (continued)

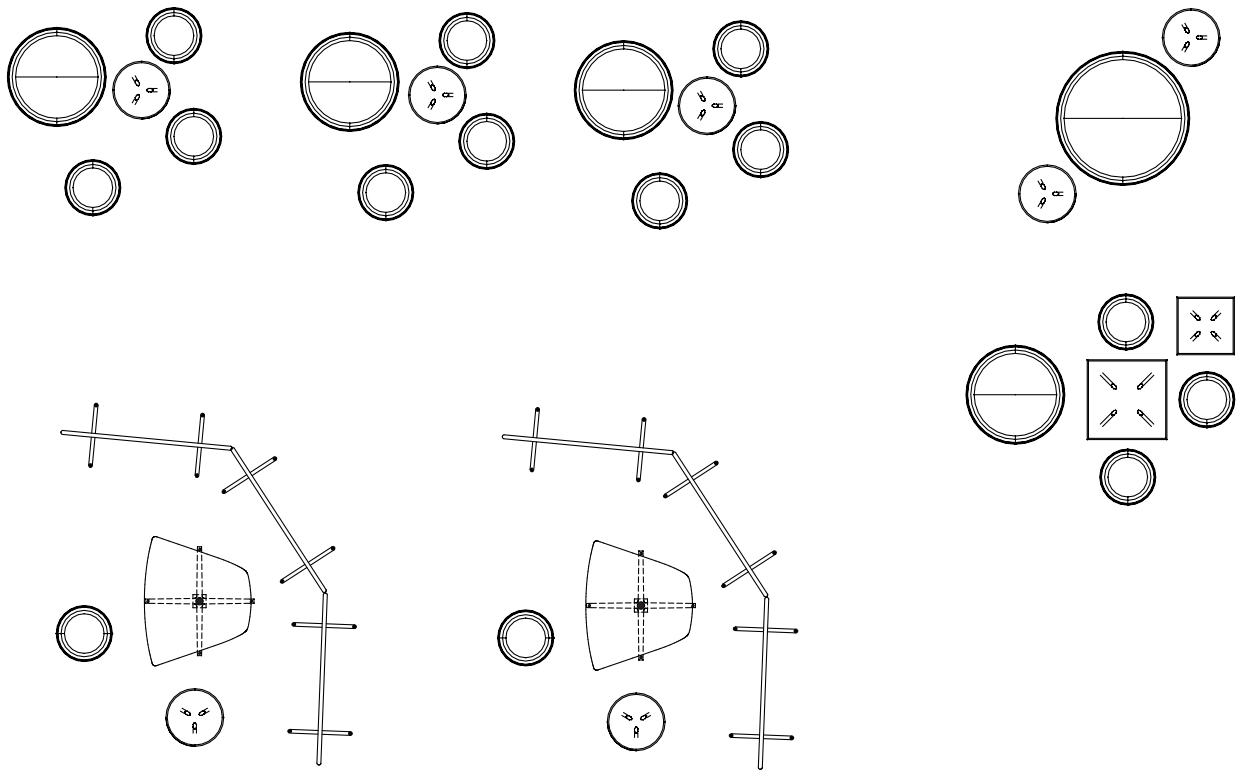

specifying qui finishes

The modularity of Qui permits a wide range of fabric that allows for an expressive use of color, texture and material. The upholstery, the mid panel, the bottom upholstery and contrasting thread color can all be finished in different fabrics if desired.

Ottoman Sizes and Configurations Available:

- 25 1/2" Small Ottoman
- 25 1/2" Small Ottoman with Casters
- 44 1/2" Medium Ottoman
- 60" Large Ottoman

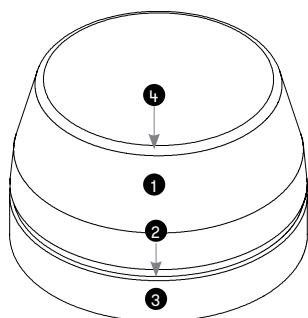

- 1** Top Upholstery
Select the top upholstery
- 2** Mid Panel
Select the mid panel finish
- 3** Base Upholstery
Select the bottom upholstery
- 4** Contrasting Thread Color
Select the contrasting thread color

specification example

STBC4 - Qui Large Ottoman, Upholstered Mid Panel, Large	
1 Top seat fabric Gr.5	5171
2 Mid panel fabric Gr.5	95
3 Base fabric Gr.5	95
Total:	\$5362

STBC4 - Qui Large Ottoman, Upholstered Mid Panel, Large	
1 Top seat fabric Gr.5	5171
2 Mid panel fabric Gr.3	67
3 Base fabric Gr.5	95
Total:	\$5334

STBC4 - Qui Large Ottoman, Upholstered Mid Panel, Large	
1 Top seat fabric Gr.5	5171
2 Mid panel fabric Gr.3	67
3 Base fabric Gr.9	140
Total:	\$5379

weights

Qui Small Ottoman	38 - 43 lbs
Qui Medium Ottoman	135 - 143 lbs
Qui Large Ottoman	235 - 243 lbs

COM/COL material requirement

Yardage is based on a non-patterned fabric. Additional yardage may be required for pattern repeats and the matching required. Leather yield may be affected by the quality of the COL. However, variance in the size of the hides will not affect the yield.

SINGLE UPHOLSTERED		COM [yards]	COL [sq. ft.]
Qui Large Ottoman	Top Seat	5	90
	Reveal	13/4	31 1/2
	Base	13/4	31 1/2
Qui Medium Ottoman	Top Seat	2 3/4	49 1/2
	Reveal	11/4	22 1/2
	Base	11/4	22 1/2
Qui Small Ottoman	Top Seat	13/4	31 1/2
	Reveal	11/4	22 1/2
	Base	11/4	22 1/2

STBA qui small ottoman – upholstered mid panel

Product Options

Style	Seat Upholstery	Mid Upholstery	Base Upholstery	Thread Finish
1 Small – 25 1/2" dia x 18" h	Fabric Leather	Fabric Leather	Fabric Leather	TCO1 White TCO2 Silver TCO3 Black TCO4 Navy TCO6 Golden Brown TCO7 Forsythia TCO8 Scarlet TCO9 Sunset TC10 Plum
2 Small with Casters 25 1/2" dia x 18" h				



		Seat												
		COM	COL	Gr.1	Gr.2	Gr.3	Gr.4	Gr.5	Gr.6	Gr.7	Gr.8	Gr.9	Gr.10	Gr.11
1	Small	1311	1390	1508	1596	1673	1760	1826	1880	1935	2001	2067	2132	2209
2	Small with Casters	1575	1670	1772	1861	1937	2024	2090	2145	2199	2265	2332	2397	2473
												Leather		
		Gr.12	Gr.13	Gr.14	Gr.15	Gr.16	Gr.17	Gr.18	Gr.19	Gr.20	LB	LC	LD	
1	Small	2297	2406	2516	2625	2735	2844	2955	3064	3174	2573	3164	3362	
2	Small with Casters	2561	2670	2781	2890	3000	3109	3219	3328	3438	2854	3445	3642	
		Mid												
		COM	COL	Gr.1	Gr.2	Gr.3	Gr.4	Gr.5	Gr.6	Gr.7	Gr.8	Gr.9	Gr.10	Gr.11
1	Small	116	116	27	38	48	59	68	75	82	92	100	109	119
2	Small with Casters	116	116	27	38	48	59	68	75	82	92	100	109	119
												Leather		
		Gr.12	Gr.13	Gr.14	Gr.15	Gr.16	Gr.17	Gr.18	Gr.19	Gr.20	LB	LC	LD	
1	Small	131	145	160	174	189	203	218	232	247	157	235	261	
2	Small with Casters	131	145	160	174	189	203	218	232	247	157	235	261	
		Base												
		COM	COL	Gr.1	Gr.2	Gr.3	Gr.4	Gr.5	Gr.6	Gr.7	Gr.8	Gr.9	Gr.10	Gr.11
1	Small	116	116	27	38	48	59	68	75	82	92	100	109	119
2	Small with Casters	116	116	27	38	48	59	68	75	82	92	100	109	119
												Leather		
		Gr.12	Gr.13	Gr.14	Gr.15	Gr.16	Gr.17	Gr.18	Gr.19	Gr.20	LB	LC	LD	
1	Small	131	145	160	174	189	203	218	232	247	157	235	261	
2	Small with Casters	131	145	160	174	189	203	218	232	247	157	235	261	

STBC qui large ottoman – upholstery mid panel

Product Options

Style	Seat Upholstery	Mid Upholstery	Base Upholstery	Thread Finish
3 Medium 44 1/2" dia x 18" h	Fabric Leather	Fabric Leather	Fabric Leather	TCO1 White TCO2 Silver TCO3 Black TCO4 Navy TCO6 Golden Brown TCO7 Forsythia TCO8 Scarlet TCO9 Sunset TC10 Plum
4 Large 60" dia x 18" h				

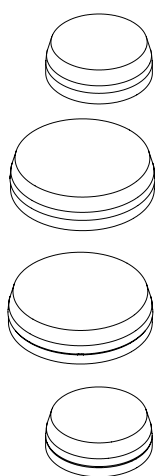

		Seat												
		COM	COL	Gr.1	Gr.2	Gr.3	Gr.4	Gr.5	Gr.6	Gr.7	Gr.8	Gr.9	Gr.10	Gr. 11
3 Medium	3	2524	2676	2768	2876	2971	3079	3160	3228	3296	3377	3458	3539	3634
	4 Large	4141	4391	4536	4711	4864	5039	5171	5280	5391	5522	5653	5785	5938
												Leather		
		Gr.12	Gr.13	Gr.14	Gr.15	Gr.16	Gr.17	Gr.18	Gr.19	Gr.20	LB	LC	LD	
3 Medium	3	3742	3878	4012	4148	4284	4418	4554	4690	4824	4138	4869	5112	
	4 Large	6113	6332	6552	6771	6990	7208	7427	7647	7866	6757	7940	8335	
		Mid												
		COM	COL	Gr.1	Gr.2	Gr.3	Gr.4	Gr.5	Gr.6	Gr.7	Gr.8	Gr.9	Gr.10	Gr. 11
3 Medium	3	116	116	27	38	48	59	68	75	82	92	100	109	119
	4 Large	116	116	37	53	67	84	95	106	116	128	140	152	167
												Leather		
		Gr.12	Gr.13	Gr.14	Gr.15	Gr.16	Gr.17	Gr.18	Gr.19	Gr.20	LB	LC	LD	
3 Medium	3	131	145	160	174	189	203	218	232	247	157	235	261	
	4 Large	183	203	224	244	264	284	305	325	346	219	329	365	
		Base												
		COM	COL	Gr.1	Gr.2	Gr.3	Gr.4	Gr.5	Gr.6	Gr.7	Gr.8	Gr.9	Gr.10	Gr. 11
3 Medium	3	116	116	27	38	48	59	68	75	82	92	100	109	119
	4 Large	116	116	37	53	67	84	95	106	116	128	140	152	167
												Leather		
		Gr.12	Gr.13	Gr.14	Gr.15	Gr.16	Gr.17	Gr.18	Gr.19	Gr.20	LB	LC	LD	
3 Medium	3	131	145	160	174	189	203	218	232	247	157	235	261	
	4 Large	183	203	224	244	264	284	305	325	346	219	329	365	

santé

features

The French celebrate by saying, “À votre santé” or “to your health.” Award winning designer Patrick Norguet created a level of elegance with his latest project, Santé. A series of versatile side chairs and stools, Simple yet smart, Santé is light and agile for movement and is comfortable for hours of work, meetings or just relaxing. Santé projects a lifestyle-oriented sensibility that softens the office landscape and expresses a more casual work culture.



dimensions

- Designed and tested for users up to 300 lbs
- Meets ANSI/BIFMA requirements

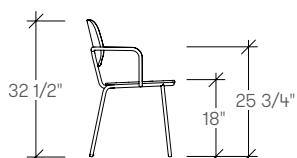
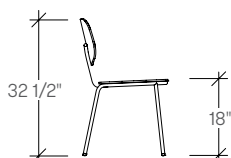
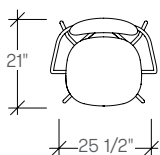
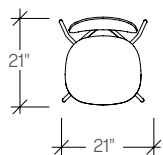

Santé Chair,
No Arms
(TKAAN)

Santé Chair,
With Arms
(TKAAA)

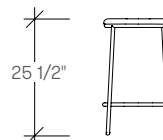
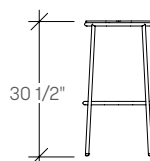
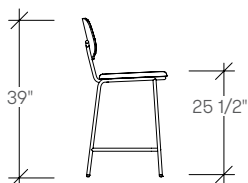
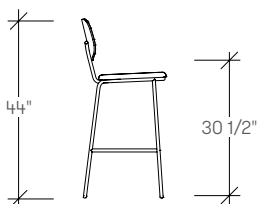
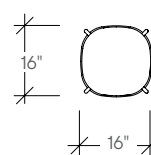
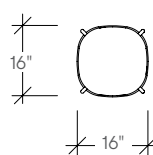
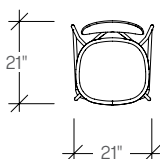
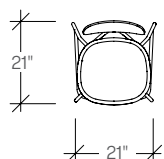

Santé Stool,
Bar Height
(TKAB1)

Santé Stool,
Counter Height
(TKAB2)

Santé Stool without Back,
Bar Height
(TKAC1)

Santé Stool without Back,
Counter Height
(TKAC2)

santé

planning

A variety of configurations can be achieved with Santé, allowing for various configurations. The following typical demonstrate the versatility that can be achieved.

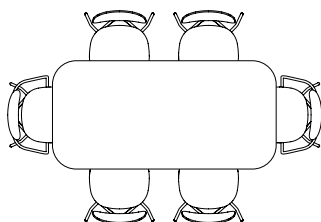
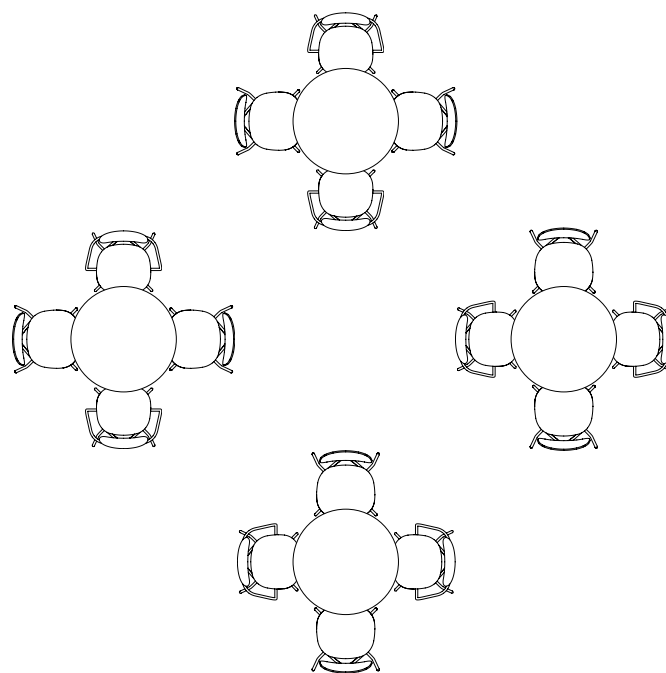
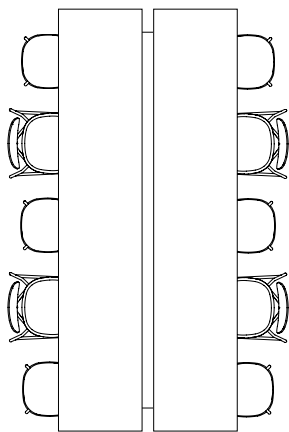
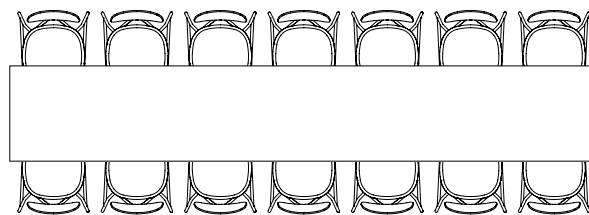
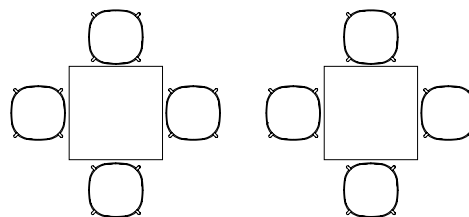
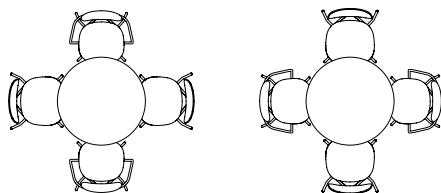
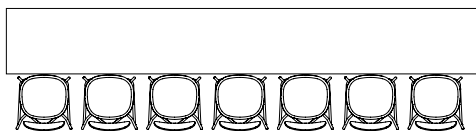

specifying santé finishes

The modularity of Santé permits a wide range of fabric combinations that allows for an expressive use of color, texture and material.

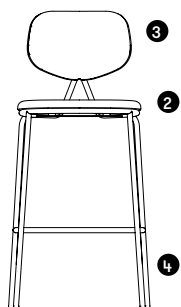

- 1 Seat Configuration**
Select the configuration
- 2 Seat Finish**
Select the seat finish
- 3 Back Upholstery**
Select the back finish
- 4 Select Base Finish**
Select base finish

specification example

TKAAAABD Santé Chair, With Arms, Upholstered Seat		
1	Seat fabric Gr.3	1447
2	Back fabric Gr.3	107
3	Base finish Fundamental Paint	0
Total:		\$1554

TKAB1BD Santé Stool with Back, Bar Height, Upholstered Seat, Upholstered Back		
1	Seat fabric Gr.3	1557
2	Back fabric Gr.3	107
3	Base finish Fundamental Paint	0
Total:		\$1664

TKAC1B Santé Stool without Back, Bar Height		
1	Seat fabric Gr.3	1238
2	Base finish Fundamental Paint	0
Total:		\$1238

TKAC1B Santé Stool without Back, Bar Height		
1	Seat fabric Gr.3	1238
2	Base finish Fashion Paint	29
Total:		\$1267

COM/COL material requirement

Yardage is based on a non-patterned fabric. Additional yardage may be required for pattern repeats and the matching required. Leather yield may be affected by the quality of the COL. However, variance in the size of the hides will not affect the yield.

		[yards]	[sq. ft.]
Santé, Chair or Stool	Seat	11/4	22 1/2
	Back	11/4	22 1/2

TKAA santé chair

Product Options

Arm Style		Seat Style		Back Style		Seat Finish		Back Finish		Base Finish	
N	No Arms	A	Veneer	C	Veneer	Studio Veneer		Studio Veneer		Fundamental Paint	
A	With Arms	B	Upholstered	D	Upholstered	Upholstery		Upholstery		Fashion Paint Chrome	

Note For Fundamental Paint, add \$0
 For Fashion Paint, add \$29
 For Chrome, add \$116



		Seat and Back												
		Studio Veneer												
N No Arms	AC Veneer Seat, Veneer Back	986												
	AD Veneer Seat, Upholstered Back	1154												
	AD Veneer Seat, Upholstered Back	COM	COL	Gr.1	Gr.2	Gr.3	Gr.4	Gr.5	Gr.6	Gr.7	Gr.8	Gr.9	Gr.10	Gr.11
	AD Veneer Seat, Upholstered Back	0	116	58	84	107	132	152	167	183	203	223	241	264
	AD Veneer Seat, Upholstered Back	Gr.12	Gr.13	Gr.14	Gr.15	Gr.16	Gr.17	Gr.18	Gr.19	Gr.20	Leather			
	AD Veneer Seat, Upholstered Back	290	322	355	386	419	451	484	515	548	LB	LC	LD	
	AD Veneer Seat, Upholstered Back										348	522	580	
		Seat												
		COM												
N No Arms	BC Upholstered Seat, Veneer Back	COM	COL	Gr.1	Gr.2	Gr.3	Gr.4	Gr.5	Gr.6	Gr.7	Gr.8	Gr.9	Gr.10	Gr.11
	BC Upholstered Seat, Veneer Back	1154	1224	1212	1238	1261	1286	1306	1321	1337	1357	1377	1395	1419
	BC Upholstered Seat, Veneer Back	Gr.12	Gr.13	Gr.14	Gr.15	Gr.16	Gr.17	Gr.18	Gr.19	Gr.20	Leather			
	BC Upholstered Seat, Veneer Back	1444	1477	1509	1540	1573	1605	1638	1669	1702		1572	1746	1804
	BC Upholstered Seat, Veneer Back	Gr.12	Gr.13	Gr.14	Gr.15	Gr.16	Gr.17	Gr.18	Gr.19	Gr.20	LB	LC	LD	
	BC Upholstered Seat, Veneer Back										1633	1807	1865	
		Seat												
		COM												
BD Upholstered Seat, Upholstered Back	BD Upholstered Seat, Upholstered Back	COM	COL	Gr.1	Gr.2	Gr.3	Gr.4	Gr.5	Gr.6	Gr.7	Gr.8	Gr.9	Gr.10	Gr.11
	BD Upholstered Seat, Upholstered Back	1212	1285	1270	1296	1319	1344	1364	1379	1395	1415	1435	1453	1477
	BD Upholstered Seat, Upholstered Back	Gr.12	Gr.13	Gr.14	Gr.15	Gr.16	Gr.17	Gr.18	Gr.19	Gr.20	Leather			
	BD Upholstered Seat, Upholstered Back	1502	1535	1567	1598	1631	1663	1696	1727	1760		1633	1807	1865
	BD Upholstered Seat, Upholstered Back	Gr.12	Gr.13	Gr.14	Gr.15	Gr.16	Gr.17	Gr.18	Gr.19	Gr.20	LB	LC	LD	
	BD Upholstered Seat, Upholstered Back										1633	1807	1865	
		Back												
		COM												
BD Upholstered Seat, Upholstered Back	BD Upholstered Seat, Upholstered Back	COM	COL	Gr.1	Gr.2	Gr.3	Gr.4	Gr.5	Gr.6	Gr.7	Gr.8	Gr.9	Gr.10	Gr.11
	BD Upholstered Seat, Upholstered Back	0	116	58	84	107	132	152	167	183	203	223	241	264
	BD Upholstered Seat, Upholstered Back	Gr.12	Gr.13	Gr.14	Gr.15	Gr.16	Gr.17	Gr.18	Gr.19	Gr.20	Leather			
	BD Upholstered Seat, Upholstered Back	290	322	355	386	419	451	484	515	548		348	522	580
	BD Upholstered Seat, Upholstered Back	Gr.12	Gr.13	Gr.14	Gr.15	Gr.16	Gr.17	Gr.18	Gr.19	Gr.20	LB	LC	LD	
	BD Upholstered Seat, Upholstered Back										348	522	580	

Pricing is continued on the following page.

TKAA **santé chair (continued)**



		Seat and Back												
		Studio Veneer												
A With Arms	AC Veneer Seat, Veneer Back	1154												
		Seat Studio Veneer												
	AD Veneer Seat, Upholstered Back	1282												
		Back												
AD Veneer Seat, Upholstered Back	COM	COL	Gr.1	Gr.2	Gr.3	Gr.4	Gr.5	Gr.6	Gr.7	Gr.8	Gr.9	Gr.10	Gr.11	
	0	116	58	84	107	132	152	167	183	203	223	241	264	
AD Veneer Seat, Upholstered Back	Gr.12	Gr.13	Gr.14	Gr.15	Gr.16	Gr.17	Gr.18	Gr.19	Gr.20	Leather				
	290	322	355	386	419	451	484	515	548	LB	LC	LD		
		Seat												
A With Arms B Upholstered Seat	BC Upholstered Seat, Veneer Back	COM	COL	Gr.1	Gr.2	Gr.3	Gr.4	Gr.5	Gr.6	Gr.7	Gr.8	Gr.9	Gr.10	Gr.11
	1282	1358	1340	1365	1389	1414	1434	1449	1465	1485	1505	1523	1546	
BC Upholstered Seat, Veneer Back	Gr.12	Gr.13	Gr.14	Gr.15	Gr.16	Gr.17	Gr.18	Gr.19	Gr.20	Leather				
	1572	1604	1637	1668	1701	1733	1766	1797	1829	LB	LC	LD		
		Seat												
BD Upholstered Seat, Upholstered Back	COM	COL	Gr.1	Gr.2	Gr.3	Gr.4	Gr.5	Gr.6	Gr.7	Gr.8	Gr.9	Gr.10	Gr.11	
	1340	1420	1398	1423	1447	1472	1492	1507	1523	1543	1563	1581	1604	
BD Upholstered Seat, Upholstered Back	Gr.12	Gr.13	Gr.14	Gr.15	Gr.16	Gr.17	Gr.18	Gr.19	Gr.20	Leather				
	1630	1662	1695	1726	1759	1791	1824	1855	1887	LB	LC	LD		
		Back												
BD Upholstered Seat, Upholstered Back	COM	COL	Gr.1	Gr.2	Gr.3	Gr.4	Gr.5	Gr.6	Gr.7	Gr.8	Gr.9	Gr.10	Gr.11	
	0	116	58	84	107	132	152	167	183	203	223	241	264	
BD Upholstered Seat, Upholstered Back	Gr.12	Gr.13	Gr.14	Gr.15	Gr.16	Gr.17	Gr.18	Gr.19	Gr.20	Leather				
	290	322	355	386	419	451	484	515	548	LB	LC	LD		

TKAB santé stool with back

Product Options

Height	Seat Style	Back Style	Seat Finish	Back Finish	Base Finish
1 Bar	A Veneer	C Veneer	Studio Veneer	Studio Veneer	Fundamental Paint
2 Counter	B Upholstered	D Upholstered	Upholstery	Upholstery	Fashion Paint Chrome

Note Bar and Counter height stools are the same price
 For Fundamental Paint, add \$0
 For Fashion Paint, add \$29
 For Chrome, add \$116



AC Veneer Seat,
Veneer Back

Seat and Back

Studio
Veneer

1218

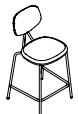

AD Upholstered Back

Seat
Studio
Veneer
1392

Back

AD Upholstered Back

COM	COL	Gr.1	Gr.2	Gr.3	Gr.4	Gr.5	Gr.6	Gr.7	Gr.8	Gr.9	Gr.10	Gr.11
0	116	58	84	107	132	152	167	183	203	223	241	264

AD Upholstered Back

Gr.12	Gr.13	Gr.14	Gr.15	Gr.16	Gr.17	Gr.18	Gr.19	Gr.20	Leather		
									LB	LC	LD
290	322	355	386	419	451	484	515	548	348	522	580

Seat

BC Upholstered Seat,
Veneer Back

COM	COL	Gr.1	Gr.2	Gr.3	Gr.4	Gr.5	Gr.6	Gr.7	Gr.8	Gr.9	Gr.10	Gr.11
1392	1476	1450	1476	1499	1524	1544	1559	1575	1595	1615	1633	1656

BC Upholstered Seat,
Veneer Back

Gr.12	Gr.13	Gr.14	Gr.15	Gr.16	Gr.17	Gr.18	Gr.19	Gr.20	Leather		
									LB	LC	LD
1682	1714	1747	1778	1811	1843	1876	1907	1940	1824	1998	2056

Seat

BD Upholstered Seat,
Upholstered Back

COM	COL	Gr.1	Gr.2	Gr.3	Gr.4	Gr.5	Gr.6	Gr.7	Gr.8	Gr.9	Gr.10	Gr.11
1450	1537	1508	1534	1557	1582	1602	1617	1633	1653	1673	1691	1714

BD Upholstered Seat,
Upholstered Back

Gr.12	Gr.13	Gr.14	Gr.15	Gr.16	Gr.17	Gr.18	Gr.19	Gr.20	Leather		
									LB	LC	LD
1740	1772	1805	1836	1869	1901	1934	1965	1998	1885	2059	2117

Back

BD Upholstered Seat,
Upholstered Back

COM	COL	Gr.1	Gr.2	Gr.3	Gr.4	Gr.5	Gr.6	Gr.7	Gr.8	Gr.9	Gr.10	Gr.11
0	116	58	84	107	132	152	167	183	203	223	241	264

BD Upholstered Seat,
Upholstered Back

Gr.12	Gr.13	Gr.14	Gr.15	Gr.16	Gr.17	Gr.18	Gr.19	Gr.20	Leather		
									LB	LC	LD
290	322	355	386	419	451	484	515	548	348	522	580

TKAC **santé stool without back**

Product Options

Height	Seat Style	Seat Finish	Base Finish
1 Bar	A Veneer	Studio Veneer	Fundamental Paint
2 Counter	B Upholstered	Upholstery	Fashion Paint Chrome

Note Bar and Counter height stools are the same price
 For Fundamental Paint, add \$0
 For Fashion Paint, add \$29
 For Chrome, add \$116



A Veneer Seat

Seat
 Studio
 Veneer
 1015



B Upholstered Seat

Seat												
COM	COL	Gr.1	Gr.2	Gr.3	Gr.4	Gr.5	Gr.6	Gr.7	Gr.8	Gr.9	Gr.10	Gr.11
1131	1199	1189	1215	1238	1263	1283	1298	1314	1334	1354	1372	1395
Seat										Leather		
Gr.12	Gr.13	Gr.14	Gr.15	Gr.16	Gr.17	Gr.18	Gr.19	Gr.20	LB	LC	LD	
1421	1453	1486	1517	1550	1582	1615	1646	1679	1547	1721	1779	

B Upholstered Seat

trine

features

The Trine Stool, designed by eStudi Manel Molina, was inspired by the classic and iconic three-legged milking stools used on farms in Spain. Manel combined his experiences of growing up on a farm and his artisanal background to create an alluring stool that is as simple as it is complex. Trine takes fabric, metal, and wood to produce a breathtaking design where a unique metal base and footrest seamlessly intertwine with metal or wooden legs. Trine's three sizes, a dining height, a bar height, and a counter height, combined with Studio TK's multiple textiles, wood finishes, and powder coating options, bring flair to all residential, hospitality, and workplace applications.



dimensions

- Designed and tested for users up to 300 lbs
- Meets ANSI/BIFMA requirements
- Metal Finishes are always Monochromatic

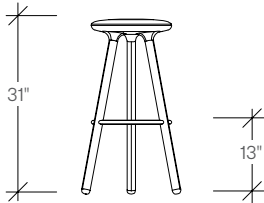
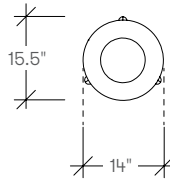
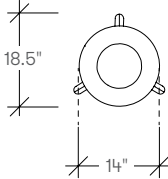
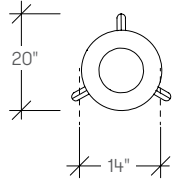

Trine Stool,
Bar Height
(TKCSM1/TKCSW1)

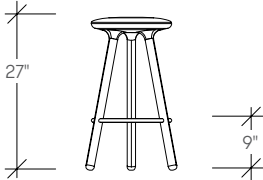

Trine Stool,
Counter Height
(TKCSM2/TKCSW2)

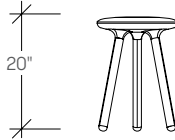

Trine Stool,
Dining Height
(TKCSM3/TKCSW3)

* Dining Height does not have foot ring

trine

planning

A variety of configurations can be achieved with Trine, allowing for various configurations. The following typical demonstrate the versatility that can be achieved.

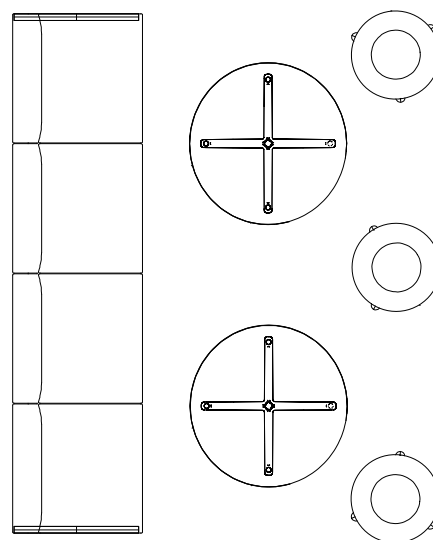
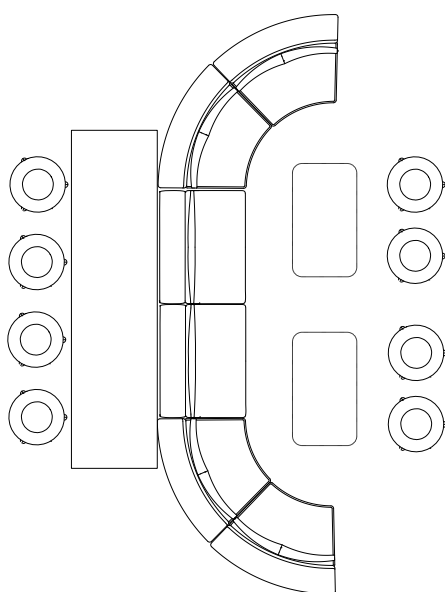
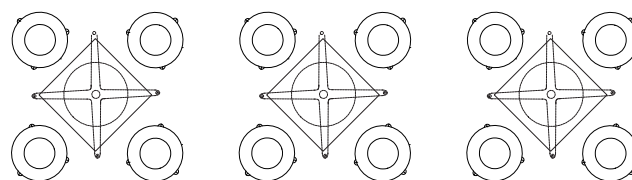
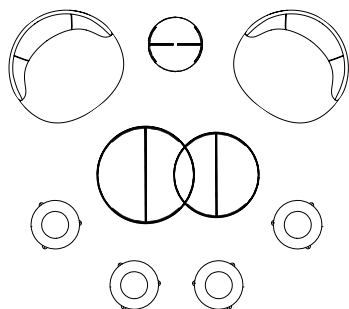
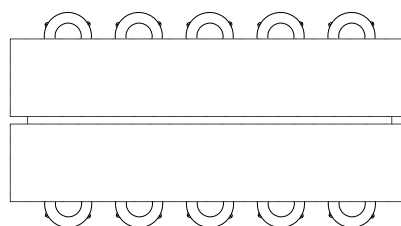
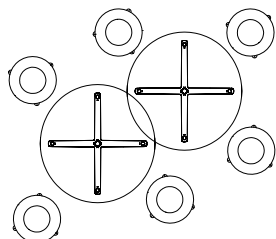

specifying trine finishes

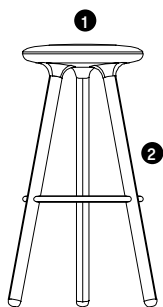

Metal Leg
[TKCSM]

- 1 Seat Upholstery**
Select the seat upholstery
- 2 Base Finish**
Select base finish
(Base Finish is Monochromatic)

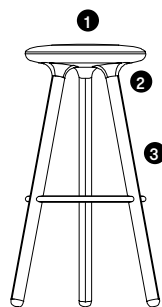

Wood Leg
[TKCSW]

- 1 Seat Upholstery**
Select the seat upholstery
- 2 Metal Base Finish**
Select base and foot ring finish
(Base Finish is Monochromatic)
- 3 Wood Leg Finish**
Select wood leg finish

specification example

TKCSM1B Trine Stool, Metal Leg, Bar Height		
1	Seat Fabric Grade 3	987
2	Base Finish Fundamental Paint	0
Total:		\$987

TKCSW1BNK Trine Stool, Wood Leg, Bar Height		
1	Seat Fabric Grade 3	1137
2	Base Finish Fundamental Paint	0
3	Wood Leg Finish	0
Total:		\$1137

TKCSM2B Trine Stool, Metal Leg, Counter Height		
1	Seat Fabric Grade 10	1033
2	Base Finish Fashion Paint	29
Total:		\$1062

TKCSW2BDV Trine Stool, Wood Leg, Counter Height		
1	Seat Fabric Grade 3	1183
2	Base Finish Fashion Paint	29
3	Wood Leg Finish	0
Total:		\$1212

TKCSM3B Trine Stool, Metal Leg, Dining Height		
1	Seat Fabric Grade 17	1056
2	Base Finish Fundamental Paint	0
Total:		\$1056

TKCSW3BDZ Trine Stool, Wood Leg, Dining Height		
1	Seat Fabric Grade 17	1156
2	Base Finish Fundamental Paint	0
3	Wood Leg Finish	0
Total:		\$1156

COM/COL material requirement

Yardage is based on a non-patterned fabric. Additional yardage may be required for pattern repeats and the matching required. Leather yield may be affected by the quality of the COL. However, variance in the size of the hides will not affect the yield.

		[yards]	[sq. ft.]
Trine Stool	Seat	1/2	9

TKCSM trine stool, metal leg

Product Options

Height	Seat Style	Seat Finish	Metal Base Finish
1 Bar	B Upholstered	Upholstery	Fundamental Paint Fashion Paint
2 Counter			
3 Dining			

Note Bar and Counter height stools are the same price
 Base Finish is monochromatic
 For Fundamental Paint, add \$0
 For Fashion Paint, add \$29



- 1 Bar Height
- 2 Counter Height
- 3 Dining Height

Seat

COM	COL	Gr.1	Gr.2	Gr.3	Gr.4	Gr.5	Gr.6	Gr.7	Gr.8	Gr.9	Gr.10	Gr.11
950	1007	970	979	987	996	1002	1008	1013	1020	1027	1033	1041
950	1007	970	979	987	996	1002	1008	1013	1020	1027	1033	1041
900	954	920	929	937	946	952	958	963	970	977	983	991



- 1 Bar Height
- 2 Counter Height
- 3 Dining Height

Gr.12	Gr.13	Gr.14	Gr.15	Gr.16	Gr.17	Gr.18	Gr.19	Gr.20
1050	1061	1072	1083	1094	1106	1117	1128	1139
1050	1061	1072	1083	1094	1106	1117	1128	1139
1000	1011	1022	1033	1044	1056	1067	1078	1089

Leather

LB	LC	LD
1127	1187	1207
1127	1187	1207
1074	1134	1154



TKCSW trine stool, wood leg

Product Options

Height	Seat Style	Seat Finish	Metal Base Finish	Wood Leg Finish
1 Bar	B Upholstered	Upholstery	Fundamental Paint Fashion Paint	BU Basque White Oak
2 Counter				NK Natural Oak
3 Dining				DY Cocoa Brown DV Sierra DZ Truffle

Note Bar and Counter height stools are the same price
 For Fundamental Paint, add \$0
 For Fashion Paint, add \$29



- 1 Bar Height
- 2 Counter Height
- 3 Dining Height

Seat

COM	COL	Gr.1	Gr.2	Gr.3	Gr.4	Gr.5	Gr.6	Gr.7	Gr.8	Gr.9	Gr.10	Gr.11
1100	1166	1120	1129	1137	1146	1152	1158	1163	1170	1177	1183	1191
1100	1166	1120	1129	1137	1146	1152	1158	1163	1170	1177	1183	1191
1000	1060	1020	1029	1037	1046	1052	1058	1063	1070	1077	1083	1091



- 1 Bar Height
- 2 Counter Height
- 3 Dining Height

Gr.12	Gr.13	Gr.14	Gr.15	Gr.16	Gr.17	Gr.18	Gr.19	Gr.20
1200	1211	1222	1233	1244	1256	1267	1278	1289
1200	1211	1222	1233	1244	1256	1267	1278	1289
1100	1111	1122	1133	1144	1156	1167	1178	1189

Leather

LB	LC	LD
1286	1346	1366
1286	1346	1366
1180	1240	1260



vettore

features

Vettore is a modular lounge system designed with classic, tailored sensibilities while offering an efficient modularity to adapt to evolving flexible work space. Designed by Toan Nguyen, Vettore configures within any environment to create intimate lounge settings or fill spacious public scenarios. Built on a universal base “stage”, Vettore allows for unlimited user specification with upholstered or table components to create a customized sofa to fit their needs. Vettore, Italian for “vector” or “array”, divides space comfortably and adds elegance to thoughtful casual work styles.

The selection of individual components allows for contrasting textiles and finishes for endless possibilities. Every sofa is custom to every environment. Vettore avoids the conventional modularity of freestanding components and adds a visual lightness to a space through a low profile base.

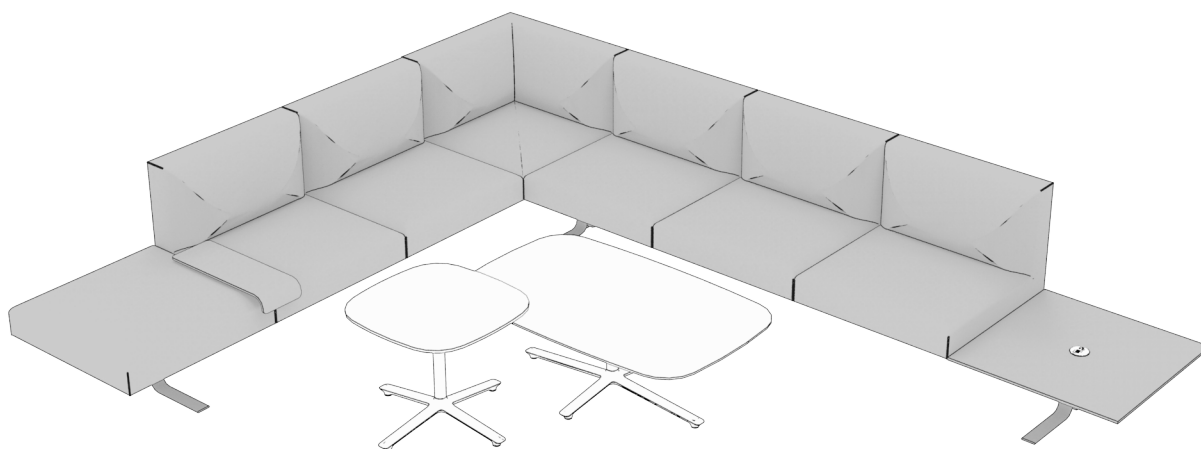

Vettore seating consists of the following preconfigured styles.

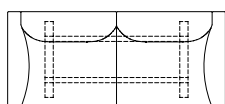

Two Seat,
Seat with Back,
Arms

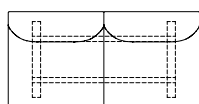

Two Seat,
Seat with Back,
No Arms

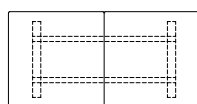

Two Seat,
No Arms

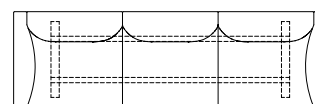

Three Seat,
Seat with Back,
Arms

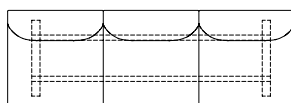

Three Seat,
Seat with Back,
No Arms

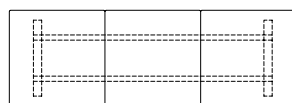

Three Seat,
No Arms

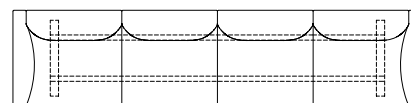

Four Seat,
Seat with Back,
Arms

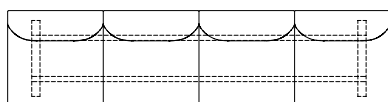

Four Seat,
Seat with Back,
No Arms

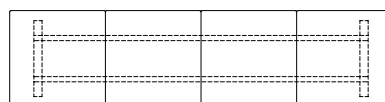

Four Seat,
No Arms

vettore

Vettore modular bases consist of the following styles.

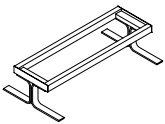

Two Seat Beam,
Metal

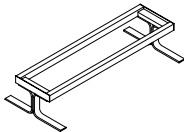

Three Seat Beam,
Metal

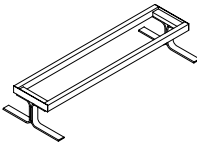

Four Seat Beam,
Metal

Vettore modular seating consists of the following styles.

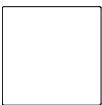

Bench

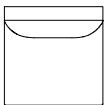

Seat with Back

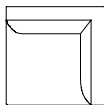

Right Side Facing
Corner

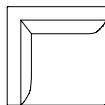

Left Side Facing
Corner

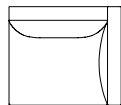

Right Side Facing
Seat with Arm

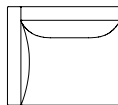

Left Side Facing
Seat with Arm

Vettore modular tables consist of the following styles.

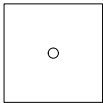

Laminate, Center
End Corner,
Cut Out for Single
Round Power Bump



Laminate, Center
End Corner,
No Power Cut Out

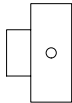

Laminate, 1/2 End,
Cut Out for Single
Round Power Bump

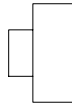

Laminate, 1/2 End,
No Power Cut Out

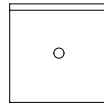

Veneer, Center,
Cut Out for Single
Round Power Bump



Veneer, Center,
No Power Cut Out

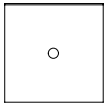

Veneer, End,
Cut Out for Single
Round Power Bump



Veneer, End,
No Power Cut Out

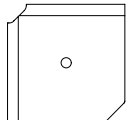

Veneer, Corner,
Cut Out for Single
Round Power Bump

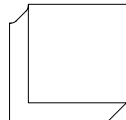

Veneer, Corner,
No Power Cut Out

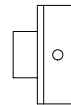

Veneer, 1/2 End,
Cut Out for Single
Round Power Bump

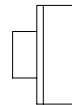

Veneer, 1/2 End,
No Power Cut Out

Vettore tablet accessories consists of the following styles.



Tablet
No Power



Tablet with
Salt Power

vettore

planning

A variety of configurations can be achieved with Vettore, allowing for various configurations. The following typical demonstrate the versatility that can be achieved.

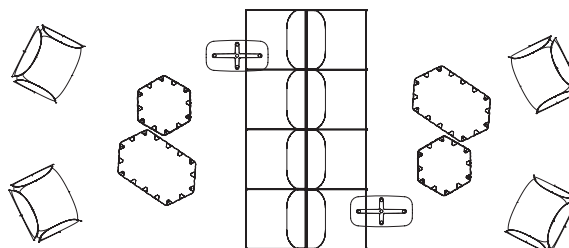
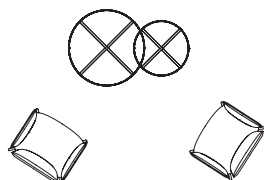
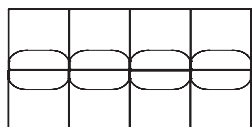
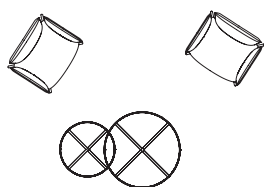
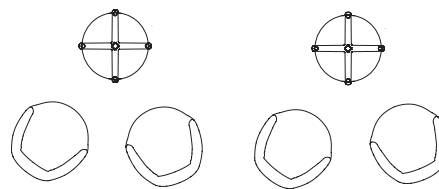
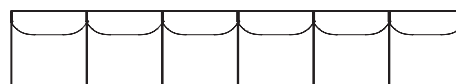
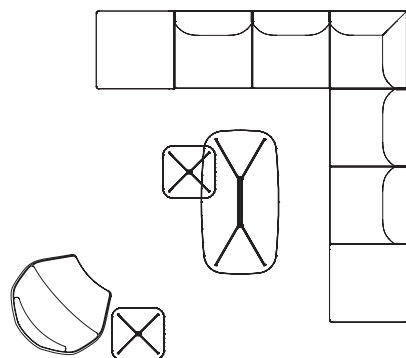
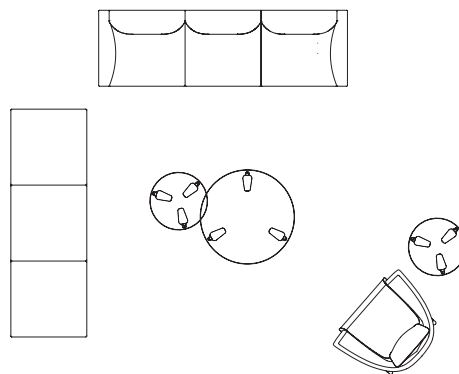
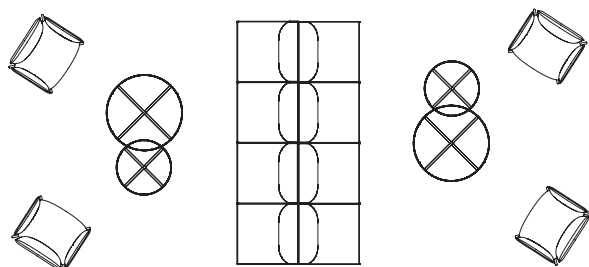

vettore

The following outlines the overall dimensions of each seating and tables.

seating heights

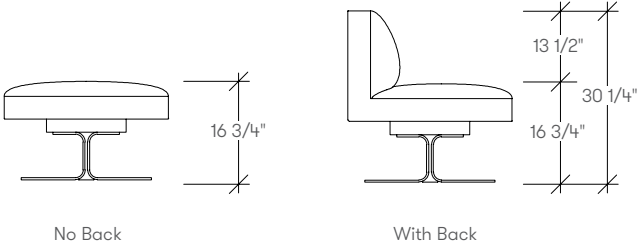

seating depths

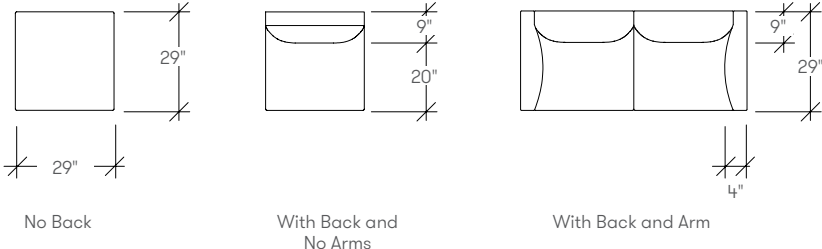

seating overall widths

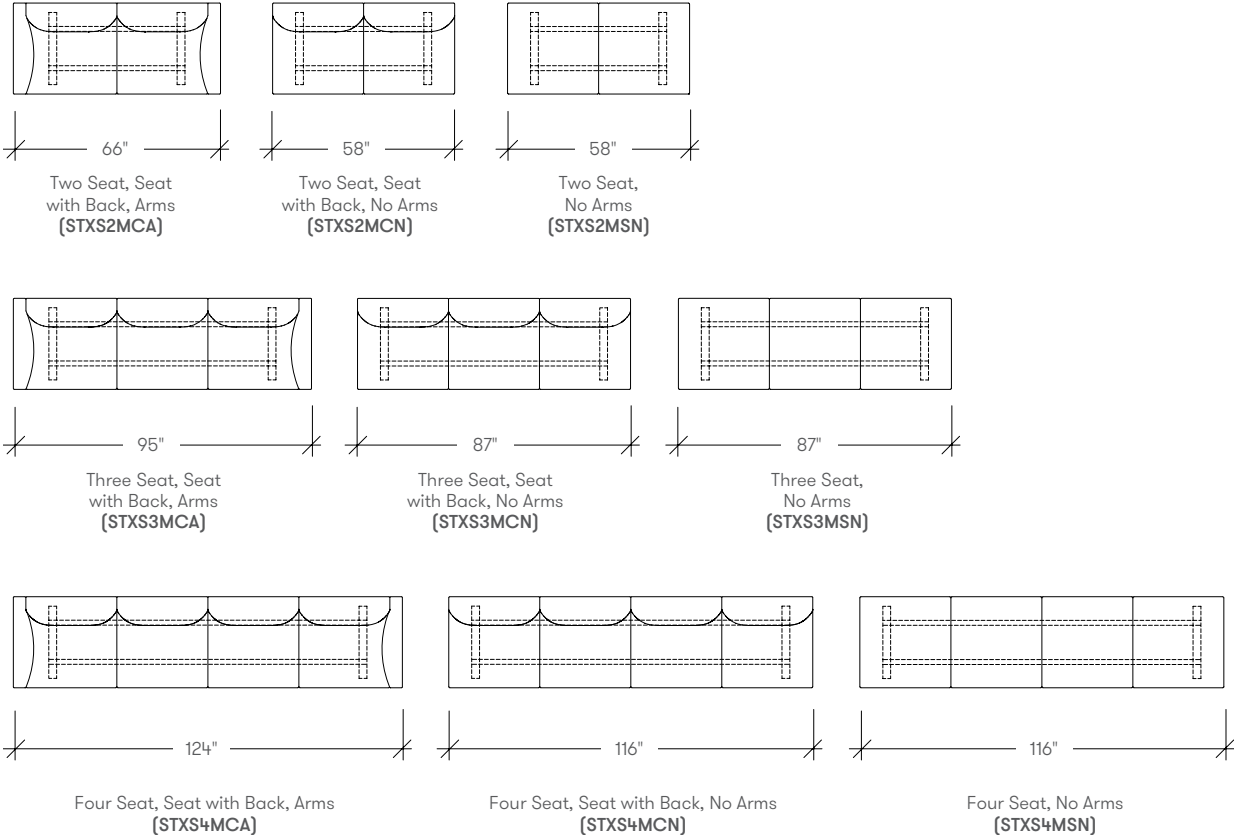

vettore

modular seating overall widths

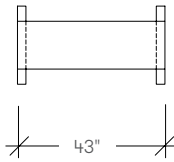

Modular Base,
Two Seat Beam
(STXB2M)

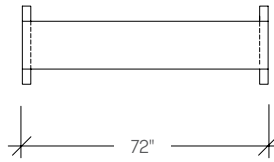

Modular Base,
Three Seat Beam
(STXB3M)

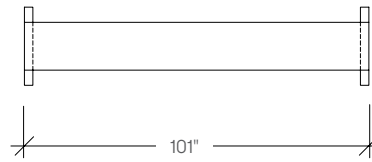

Modular Base,
Four Seat Beam
(STXB4M)

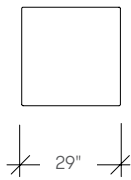

Modular Seat,
Bench
(STXUA)

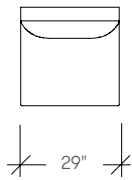

Modular Seat,
Seat with Back
(STXUB)

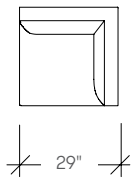

Modular Seat,
Right Side Facing
Corner
(STXUC)

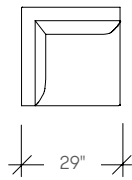

Modular Seat,
Left Side Facing
Corner
(STXUD)

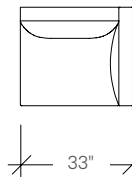

Modular Seat,
Right Side Facing
Seat with Arm
(STXUE)
*Arm unit may only be
used as an end piece*

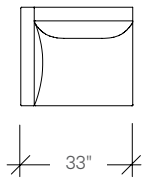

Modular Seat,
Left Side Facing
Seat with Arm
(STXUF)
*Arm unit may only be
used as an end piece*

modular tables overall heights and widths

Table Height off floor: 12"

Table Thickness: 1/2" Laminate
1/2" Veneer

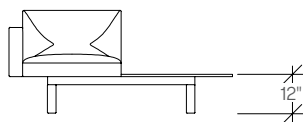

Modular Tables
(Centre End Table Shown)

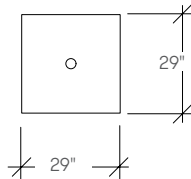

Center Tables -
Laminate and Veneer

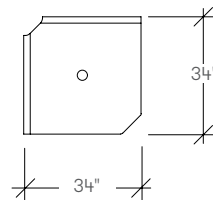

Corner Tables - Veneer

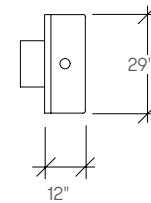

1/2" End Tables -
Laminate and
Veneer

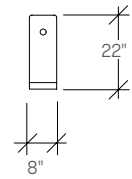

Tablet Accessory

specifying vettore finishes

The following outlines the specification process for Vettore fabric selections.

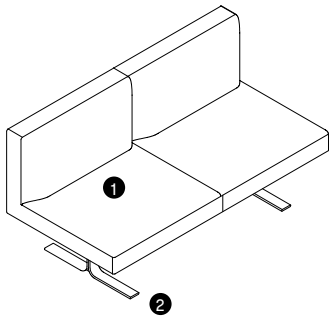

- 1 Seat and Back Upholstery
Select the seat and back upholstery
- 2 Base Finish
Select the base finish

Left or Right corners are determined by the fabric pattern direction in the seat of the corner module. Please keep this in mind as you as specifying a sectional or piece with corner use particularly with a patterned or directional fabric.

Leg Style

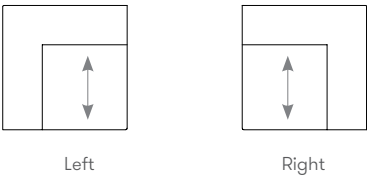

vettore power accessories

Power can be specified on Vettore Modular tables which is positioned in the center of the tables. Single Round Power Bump accessory is sold separately for Vettore Seating and Modular Tables.

vettore seating

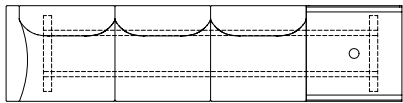

Modular Tables
(Centre End Table
Shown)

vettore modular seating

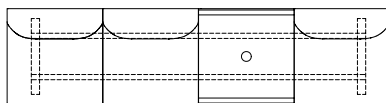

Center Tables -
Laminate and Veneer

vettore tablet accessory with salt power

Power is included on Vettore Tablets with Salt Power. Power can be routed on the underside of the bench with magnetic cable managers to the nearest leg or power monument.

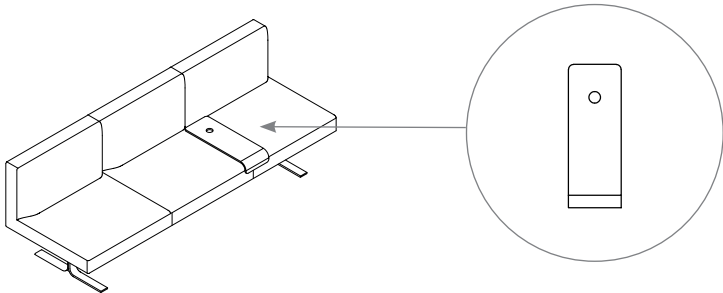

Cutout - Round 1-3/4" USB-A
Only White or Ebony
North American plug only 6 ft cord

vettore

specifying vettore modular seating

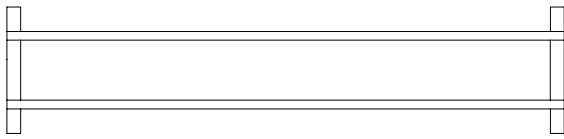

- 1 Select the base assembly size
(Two Seat, Three Seat or Four Seat)
- 2 Select base finish
(Foundation Paint or Fashion Paint)

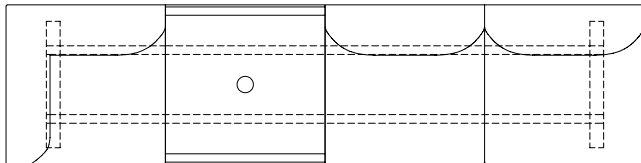

- 1 Select coordinating quantity of upholstered or table modular pieces to be assembled to the base style
- 2 Select upholstery finish
- 3 Select table finish, if applicable

specification example

The following layouts can be specified two different ways.

layout 1

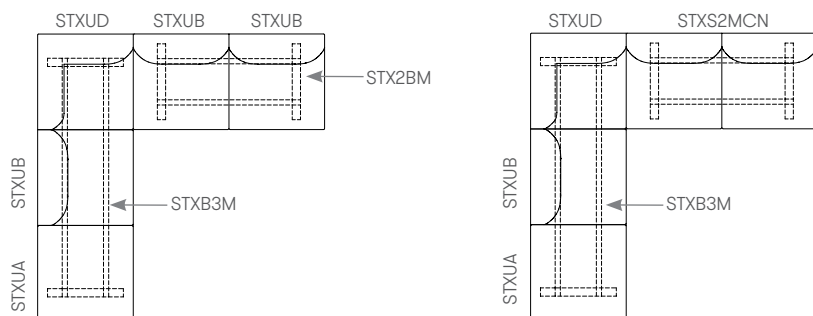
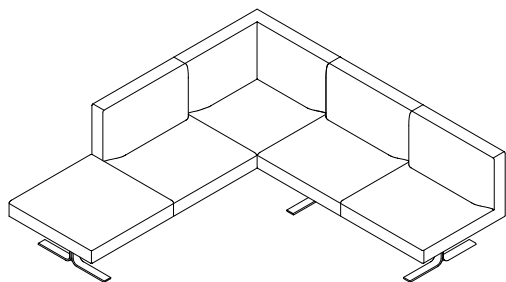

Layout 1 A

1	STXB2M	Vettore Modular Base, 2 Seat Beam, Metal	1334
1	STXB3M	Vettore Modular Base, 4 Seat Beam, Metal	1392
1	STXUA	Vettore Modular Seat, Bench Gr. 3	1209
1	STXUD	Vettore Modular Seat, Left Side Facing Corner Gr. 3	2413
3	STXUB	Vettore Modular Seat, Seat with Back Gr. 3	1885

Total: \$12003

Layout 1 B

1	STXB3M	Vettore Modular Base, 3 Seat Beam, Metal	1392
1	STXUA	Vettore Modular Seat, Bench Gr 3	1209
1	STXUB	Vettore Modular Seat, Seat with Back Gr. 3	1885
1	STXUD	Vettore Modular Seat, Left Side Facing Corner Gr. 3	2413
1	STXS2MCN	Vettore Modular Seat, Seat with Back Gr. 3	5104

Total: \$12003

specification example

The following layouts can be specified two different ways.

layout 2

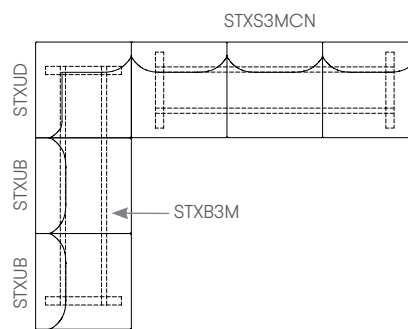
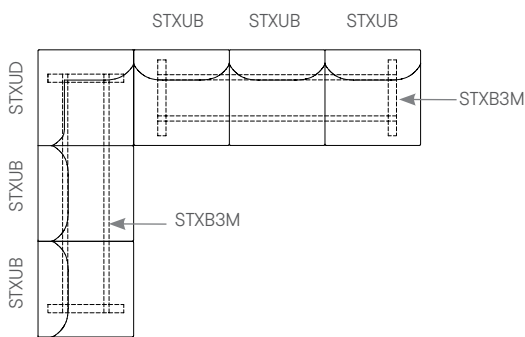
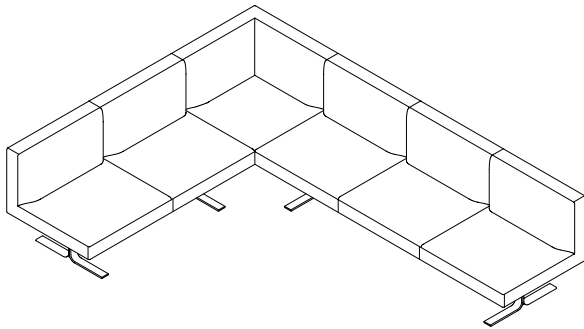

Layout 2 A			
2	STXB3M	Vettore Modular Base, 3 Seat Beam, Metal	1392
5	STXUB	Vettore Modular Seat, Seat with Back Gr. 3	1885
1	STXUD	Vettore Modular Seat, Left Side Facing Corner Gr. 3	2413
Total:			\$14622

Layout 2 B			
1	STXB3M	Vettore Modular Base, 3 Seat Beam, Metal	1392
2	STXUB	Vettore Modular Seat, Seat with Back	1885
1	STXUD	Vettore Modular Seat, Left Side Facing Corner	2413
1	STXS3MCN	Vettore Seating, 3 Seat, Metal, Seat with Back, No Arms	7047
Total:			\$14622

specification example

The following layouts can be specified two different ways.

layout 3

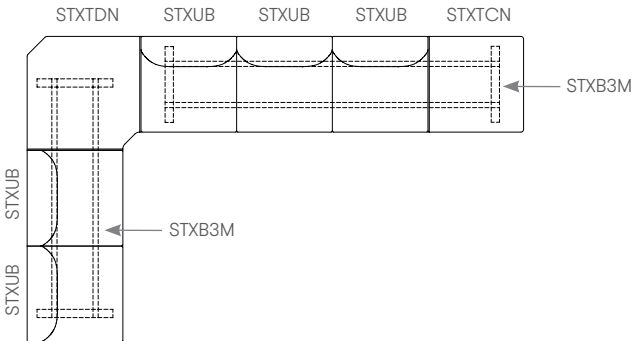
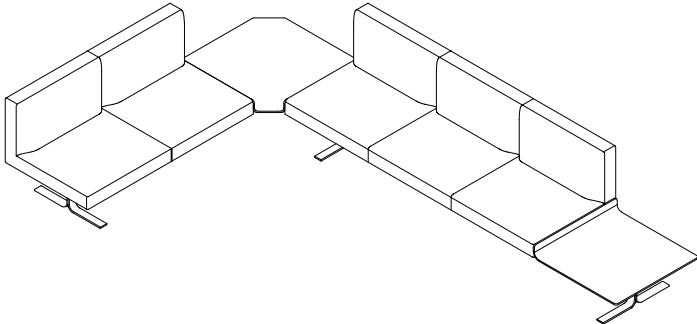

Layout 3			
1	STXB3M	Vettore Modular Base, 3 Seat Beam, Metal	1392
1	STXB4M	Vettore Modular Base, 4 Seat Beam, Metal	1450
5	STXUB	Vettore Modular Seat, Seat with Back	1885
1	STXTCN	Vettore Modular Table, Veneer, End, No Power Cut-Out	1334
1	STXTDN	Vettore Modular Table, Veneer, Corner, No Power Cut-Out	1914
Total:			\$15515

specification example

The following layouts can be specified two different ways.

layout 4

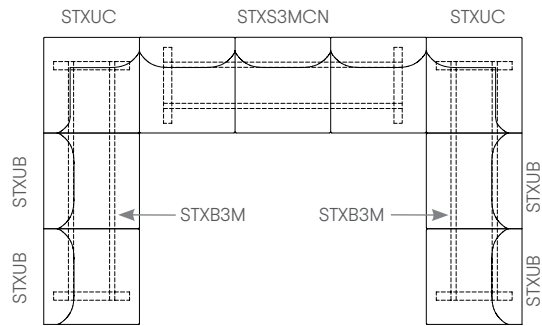
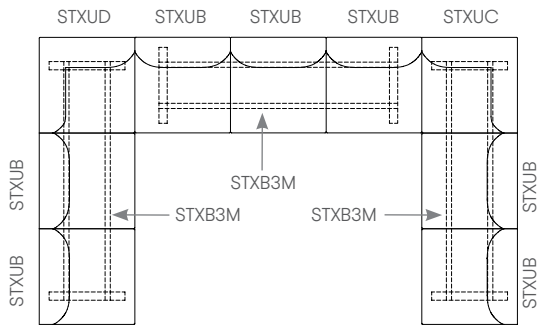
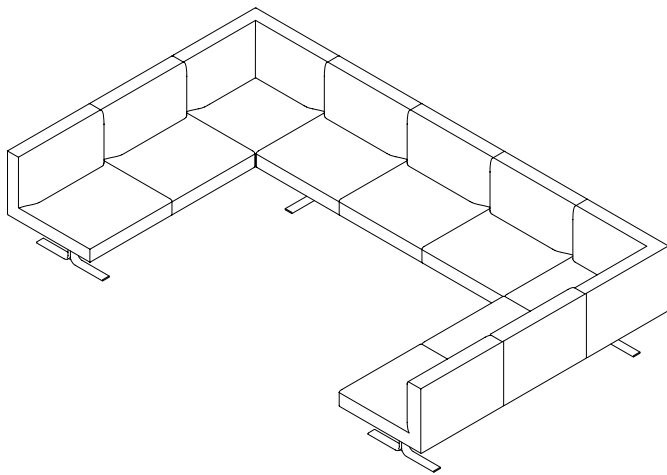

Layout 4 A			
3	STXB3M	Vettore Modular Base, 3 Seat Beam, Metal	1392
7	STXUB	Vettore Modular Seat, Seat with Back	1885
1	STXUC	Vettore Modular Seat, Right Side Facing Corner	2413
1	STXUD	Vettore Modular Seat, Left Side Facing Corner	2413
Total:			\$22197

Layout 4 B			
2	STXB3M	Vettore Modular Base, 3 Seat Beam, Metal	1392
4	STXUB	Vettore Modular Seat, Seat with Back	1885
2	STXUC	Vettore Modular Seat, Right Side Facing Corner	2413
1	STXS3MCN	Vettore Seating, 3 Seat, Metal, Seat with Back, No Arms	7047
Total:			\$22197

specification example

STXS2MCN – Vettore Seating, Two Seat, Metal, Seat with Back, No Arms		
①	Seat fabric Gr.3	5220
②	Leg finish Fashion Paint	29
Total:		\$5249

STXS3MSN – Vettore Seating, Three Seat, Metal, Seat, No Arms		
①	Seat and back fabric Gr.5	4553
②	Leg finish Fundamental Paint	0
③	Total:	\$4553

STXS4MCN – Vettore Seating, Four Seat, Metal with Back, No Arms		
①	Seat fabric Gr.5	9619
②	Leg finish Fashion Paint	29
Total:		\$9648

COM/COL material requirement

Yardage is based on a non-patterned fabric. Additional yardage may be required for pattern repeats and the matching required. Leather yield may be affected by the quality of the COL. However, variance in the size of the hides will not affect the yield.

SINGLE UPHOLSTERED		COM [yards]	COL [sq. ft.]
Vettore Modular Seat	Bench	2	36
	Seat with Back	3 3/4	67 1/2
	Corner	5 1/4	94 1/2
	Seat & Back with Arm	5 1/2	99
Vettore Seating, Two Seat, Metal Leg	Seat Only without Arm	4	72
	Seat & Back without Arm	7 1/2	135
	Seat & Back with Arm	11	198
Vettore Seating, Three Seat, Metal Leg	Seat Only without Arm	6	108
	Seat & Back without Arm	11 1/4	202 1/2
	Seat & Back with Arm	14 3/4	265 1/2
Vettore Seating, Four Seat, Metal Leg	Seat Only without Arm	8	144
	Seat & Back without Arm	15	270
	Seat & Back with Arm	18 1/2	333

STXS **vettore seating**

Product Options

Style	Leg Style	Back Style	Arm Style	Upholstery	Leg Finish
2 Two Seat	M Two Metal	S Seat	N No Arms	Fabric	Fundamental Paint
3 Three Seat		C Seat with Back	A With Arms (available with seat with back option only)	Leather	Fashion Paint
4 Four Seat					

Note For Fundamental Paint, add \$0
 For Fashion Paint, add \$29
 Seat and Seat with Back models may be ganged together for longer lounge configurations. Ganging hardware included.
 No assembly required on Two, Three and Four Bench or Sofa Seating models

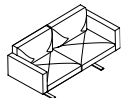
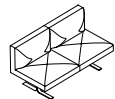
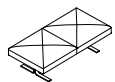

		Seat												
		COM	COL	Gr.1	Gr.2	Gr.3	Gr.4	Gr.5	Gr.6	Gr.7	Gr.8	Gr.9	Gr.10	Gr.11
2	Two Seat													
	Metal, Seat	3410	3820	3596	3678	3750	3833	3895	3946	3999	4060	4121	4184	4256
	Metal, Seat with Back, No Arms	4466	5002	4814	4968	5104	5258	5374	5472	5568	5684	5800	5916	6052
3	Three Seat													
	Metal, Seat	4507	5047	4785	4909	5017	5141	5234	5310	5388	5481	5574	5667	5774
	Metal, Seat with Back, No Arms	6090	6821	6612	6844	7047	7279	7453	7598	7743	7917	8091	8265	8468
4	Four Seat													
	Metal, Seat	6954	7788	7639	7943	8209	8513	8742	8931	9121	9350	9578	9805	10072
	Metal, Seat with Back, Arms	5603	6276	5974	6139	6284	6448	6573	6675	6778	6902	7026	7149	7294
2	Two Seat													
	Metal, Seat	7714	8640	8410	8720	8990	9300	9532	9724	9918	10150	10382	10614	10884
	Metal, Seat with Back, Arms	8746	9796	9605	9986	10321	10702	10988	11226	11464	11751	12037	12323	12657
		Leather										LB	LC	LD
2	Two Seat													
	Metal, Seat	4338	4442	4545	4648	4751	4853	4957	5060	5163		4933	5490	5676
	Metal, Seat with Back, No Arms	6206	6400	6592	6786	6980	7172	7366	7560	7752		7090	8134	8482
3	Three Seat													
	Metal, Seat	8050	8333	8618	8901	9185	9468	9752	10035	10319		9221	10752	11262
	Metal, Seat with Back, Arms	5899	6053	6208	6363	6517	6672	6827	6981	7136		6718	7553	7831
4	Four Seat													
	Metal, Seat	8700	8990	9280	9570	9860	10150	10440	10730	11020		9953	11519	12041
	Metal, Seat with Back, Arms	10376	10757	11137	11516	11897	12277	12658	13037	13418		11895	13948	14632
4	Four Seat													
	Metal, Seat	7459	7665	7872	8077	8284	8490	8697	8902	9108		8503	9616	9988
	Metal, Seat with Back, No Arms	11194	11580	11968	12354	12740	13128	13514	13900	14288		12816	14904	15600
	Metal, Seat with Back, Arms	13038	13515	13992	14469	14945	15423	15900	16377	16854		14947	17522	18380

STXB vettore modular base

Product Options

Style	Leg Style	Leg Finish
2 Two Seat Beam	M Metal	Fundamental Paint
3 Three Seat Beam		Fashion Paint
4 Four Seat Beam		

Note The Fundamental or Fashion Paint is for the leg portion only
 The non-visible beam is an anthracite black finish
 Base-to-base ganging hardware included

Price



	Foundation Paint	Fashion Paint
2 Two Seat Beam	1334	1363
3 Three Seat Beam	1392	1421
4 Four Seat Beam	1450	1479

STXU vettore modular seat

Product Options

Style	Upholstery
A Bench	Fabric Leather
B Seat with Back	
C Right Side Facing Corner	
D Left Side Facing Corner	
E Right Side Facing Seat with Arm	
F Left Side Facing Seat with Arm	

Note Seats with Arms must be used as an end piece within the configuration. These CANNOT be used in the middle of a modular configuration
 Assembly hardware included

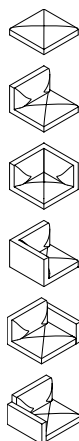

	Seat											Leather				
	COM	COL	Gr.1	Gr.2	Gr.3	Gr.4	Gr.5	Gr.6	Gr.7	Gr.8	Gr.9	Gr.10	Gr. 11	LB	LC	LD
A Bench	1038	1162	1131	1173	1209	1249	1281	1306	1332	1363	1394	1424	1460			
B Seat with Back	1566	1754	1740	1818	1885	1963	2021	2068	2117	2175	2233	2291	2358			
C Right Side Facing Corner	1966	2202	2210	2318	2413	2521	2602	2670	2738	2819	2900	2981	3076			
D Left Side Facing Corner	1966	2202	2210	2318	2413	2521	2602	2670	2738	2819	2900	2981	3076			
E Right Side Facing Seat with Arm	2082	2332	2337	2451	2550	2663	2748	2820	2891	2975	3060	3146	3245			
F Left Side Facing Seat with Arm	2082	2332	2337	2451	2550	2663	2748	2820	2891	2975	3060	3146	3245			
A Bench	Gr.12	Gr.13	Gr.14	Gr.15	Gr.16	Gr.17	Gr.18	Gr.19	Gr.20							
B Seat with Back	1502	1553	1605	1656	1709	1760	1812	1863	1915					1719	1998	2090
C Right Side Facing Corner	2436	2532	2630	2726	2822	2920	3016	3112	3210					2798	3320	3494
D Left Side Facing Corner	3184	3320	3454	3590	3726	3860	3996	4132	4266					3663	4394	4638
E Right Side Facing Seat with Arm	3184	3320	3454	3590	3726	3860	3996	4132	4266					3663	4394	4638
F Left Side Facing Seat with Arm	3358	3500	3641	3784	3925	4067	4208	4351	4493					3863	4628	4884
F Left Side Facing Seat with Arm	3358	3500	3641	3784	3925	4067	4208	4351	4493					3863	4628	4884

STXT **vettore modular table, laminate**



Product Options

Style	Power	Surface Finish
A Center End Corner	N No Power Cut Out	Studio Foundation Laminate
F 1/2 End	D Cut Out for Single Round Power Bump	

Note For Cut Out for Single Round Power Bump [D] - POWER UNIT SOLD SEPARATELY
 STXTA can be used as an Center, End or Corner table within the module of the base beam
 STXTF is used with the Modular Base. If a Two Seat Beam is specified, two upholstered units need to be specified with the addition of the 1/2 End Table to add after assembly
 Assembly hardware included

Price

Studio
Foundation
Laminate

	A Center End Corner No Power Cut Out Cut Out
	F 1/2 End No Power Cut Out Cut Out

922
945
806
899

STXT **vettore modular table, veneer**





Product Options

Style	Power	Surface Finish
B Center	N No Power Cut Out	Studio Veneer
C End	D Cut Out for Single Round Power Bump	
D Corner		
E 1/2 End		

Note For Cut Out for Single Round Power Bump [D] - POWER SOLD SEPARATELY
 STXTE is used with the Modular Base. If a Two Seat Beam is specified, two upholstered units need to be specified with the addition of the 1/2 End Table to add after assembly.

Price

Studio
Foundation
Laminate

	B Center No Power Cut Out Cut Out
	C End No Power Cut Out Cut Out
	D Corner No Power Cut Out Cut Out
	E 1/2 End No Power Cut Out Cut Out

1641
1665
1334
1357
1914
1937
1270
1363

STXA vettore tablet accessories

Product Options

Power	Surface Finish	Power Finish
N No Power	Studio Veneer	8B Ebony Coordinate
S Salt USB-A Power	Studio Foundation Laminate	7Y Storm White Coordinate

Note Salt Power INCLUDED - USB ONLY
 Laminate and Veneer versions are both curved tablets
 Tablet should only be used between two upholstered seats

Price

	Studio Foundation Laminate	Studio Veneer
N No Power	986	1154
S Salt USB-A Power	1218	1386





screens

Lite Wall 3 0 6

lite wall

features

The Lite Wall is a freestanding screen that provides visual space division. It has a magnetic connection between screens which helps establish borders for workstations and private spaces. The Lite Wall is easily reconfigurable without tools and visible connections.

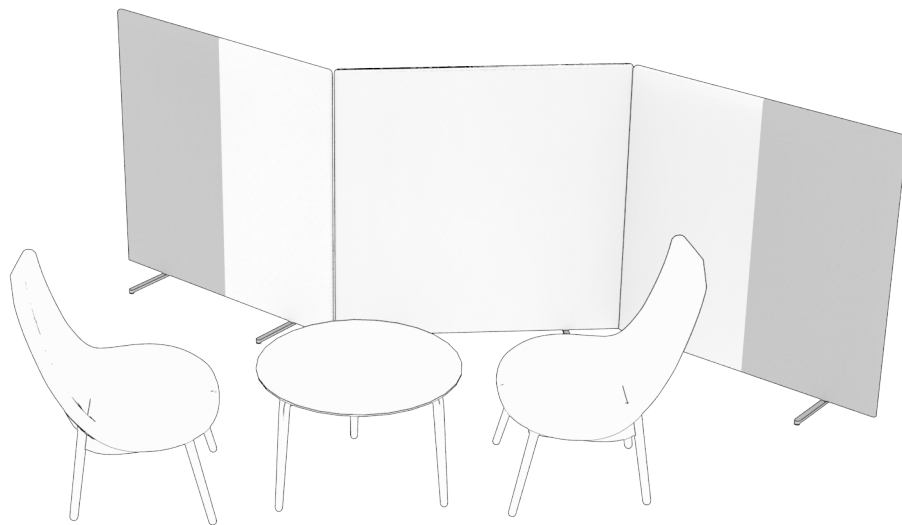

dimensions

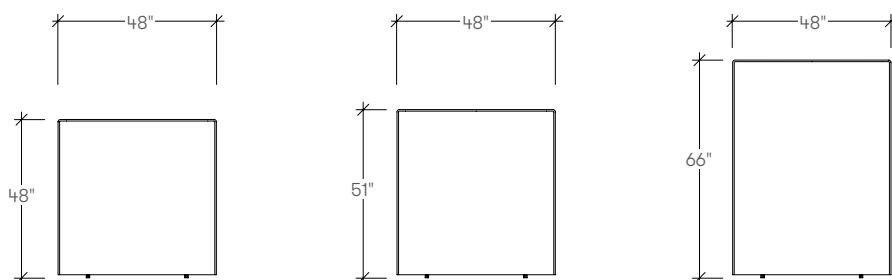

finishes:
Foot Finish available in:
Chrome

lite wall

planning

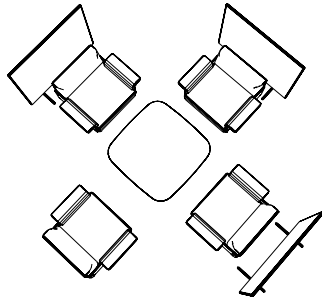

common area privacy

Shown with
48" high Lite Wall screens

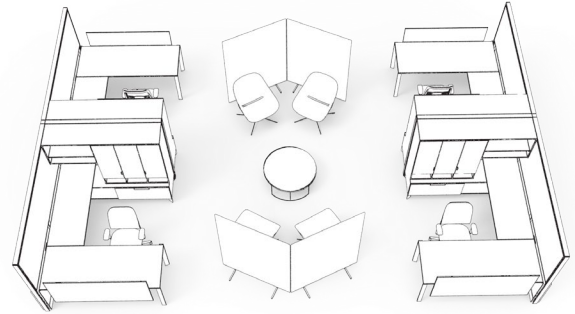

meeting area privacy within workstations

District workstations with Beso Chairs,
66" high Lite Wall screens

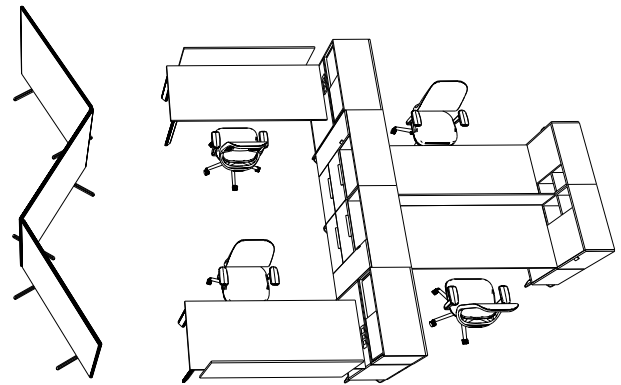
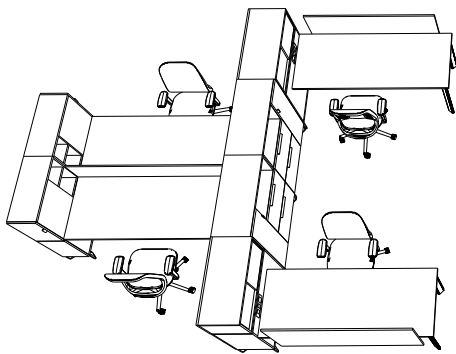

space division between workstations

Shown with District open workstation,
51" high Lite Wall screens

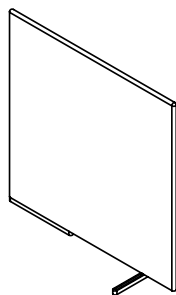

The feet on the Lite Wall pivot under the screen for ease of shipping.

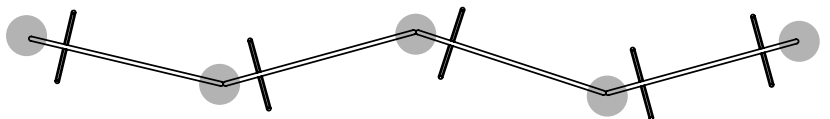

The Lite Wall has an optional magnet on each end to allow screens to attach to one another.

lite wall

finish options

Lite Wall can be specified with one fabric, two fabrics (contrasting sides) or divided in the center.

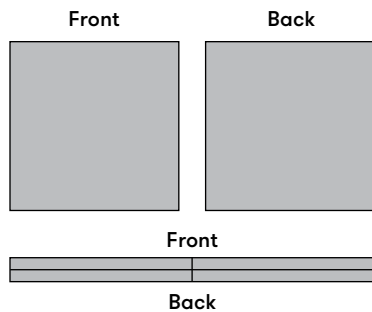

Single Upholstery
STSDA

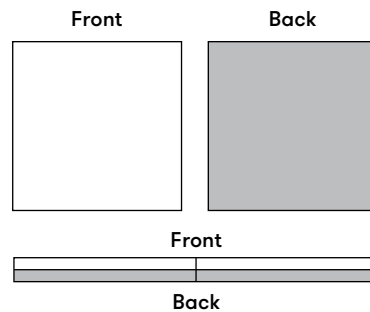

Contrast Upholstery - Sided
STSDB

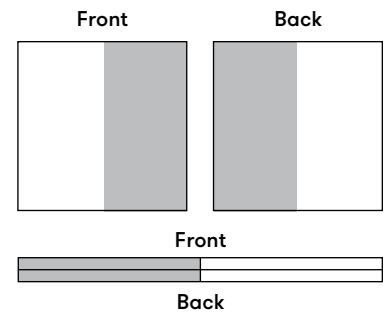

Contrast Upholstery - Center Divide
STSDC

Note The front of the contrasting panel must match the back.

STSD Lite Wall

Product Options

Style	Height	Width	Magnet	Upholstery Finish	Frame Finish	Foot Finish
A Full Upholstery	48", 51", 66"	48"	N No Magnet E Magnet	Fabric	8 Arctic	C6 Chrome

Note For Non-Magnet, add \$0
For Magnet, add \$307

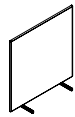
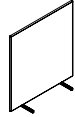
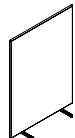
		Price											
		Panel 1	Panel 1	Panel 1	Panel 1	Panel 1	Panel 1	Panel 1	Panel 1	Panel 1	Panel 1	Panel 1	Panel 1
		COM	Gr.1	Gr.2	Gr.3	Gr.4	Gr.5	Gr.6	Gr.7	Gr.8	Gr.9	Gr.10	Gr.11
	A Full Upholstery												
	48"h x 48"w	1401	1494	1536	1572	1612	1644	1669	1695	1726	1757	1788	1824
	51"h x 48"w	1456	1549	1590	1626	1667	1698	1724	1749	1781	1812	1842	1878
	66"h x 48"w	1523	1639	1690	1735	1788	1826	1858	1891	1929	1967	2007	2052
		Gr.12	Gr.13	Gr.14	Gr.15	Gr.16	Gr.17	Gr.18	Gr.19	Gr.20			
	A Full Upholstery												
	48"h x 48"w	1865	1916	1969	2020	2072	2123	2175	2226	2278			
	51"h x 48"w	1920	1971	2023	2074	2126	2177	2230	2281	2333			
	66"h x 48"w	2103	2168	2232	2297	2361	2426	2489	2554	2618			
	A Full Upholstery												
	48"h x 48"w												
	51"h x 48"w												

STSD Lite Wall

Product Options

Style	Height	Width	Magnet	Fabric Finish	Frame Finish	Foot Finish
B Contrast Upholstery - Sided	48", 51", 66"	48"	N No Magnet	Upholstery Finish	8 Arctic	C6 Chrome
C Contrast Upholstery - Center Divide			E Magnet			

Note For Non-Magnet, add \$0
For Magnet, add \$307

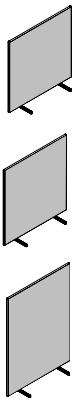

Price

	Panel 1 COM	Panel 1 Gr.1	Panel 1 Gr.2	Panel 1 Gr.3	Panel 1 Gr.4	Panel 1 Gr.5	Panel 1 Gr.6	Panel 1 Gr.7	Panel 1 Gr.8	Panel 1 Gr.9	Panel 1 Gr.10	Panel 1 Gr.11
B Contrast Upholstery - Sided												
48"h x 48"w	1401	1494	1536	1572	1612	1644	1669	1695	1726	1757	1788	1824
51"h x 48"w	1456	1549	1590	1626	1667	1698	1724	1749	1781	1812	1842	1878
66"h x 48"w	1523	1639	1690	1735	1788	1826	1858	1891	1929	1967	2007	2052
	Gr.12	Gr.13	Gr.13	Gr.15	Gr.16	Gr.16	Gr.18	Gr.19	Gr.20			
B Contrast Upholstery - Sided												
48"h x 48"w	1865	1916	1969	2020	2072	2123	2175	2226	2278			
51"h x 48"w	1920	1971	2023	2074	2126	2177	2230	2281	2333			
66"h x 48"w	2103	2168	2232	2297	2361	2426	2489	2554	2618			
	Panel 2 COM	Panel 2 Gr.1	Panel 2 Gr.2	Panel 2 Gr.3	Panel 2 Gr.4	Panel 2 Gr.5	Panel 2 Gr.6	Panel 2 Gr.7	Panel 2 Gr.8	Panel 2 Gr.9	Panel 2 Gr.10	Panel 2 Gr.11
B Contrast Upholstery - Sided												
48"h x 48"w	0	42	60	77	95	109	121	132	146	160	174	190
51"h x 48"w	0	42	60	77	95	109	121	132	146	160	174	190
66"h x 48"w	0	52	60	77	95	109	121	132	146	160	174	190
	Gr.12	Gr.13	Gr.13	Gr.15	Gr.16	Gr.16	Gr.18	Gr.19	Gr.20			
B Contrast Upholstery - Sided												
48"h x 48"w	209	232	255	278	302	325	348	371	394			
51"h x 48"w	209	232	255	278	302	325	348	371	394			
66"h x 48"w	209	232	255	278	302	325	348	371	394			

STSD Lite Wall (continued)

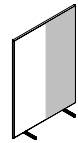
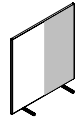
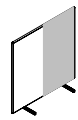

		Price											
		Panel 1	Panel 1	Panel 1	Panel 1	Panel 1	Panel 1	Panel 1	Panel 1	Panel 1	Panel 1	Panel 1	Panel 1
		COM	Gr.1	Gr.2	Gr.3	Gr.4	Gr.5	Gr.6	Gr.7	Gr.8	Gr.9	Gr.10	Gr.11
C	Contrast Upholstery												
	- Center Divide												
	48"h x 48"w	1401	1494	1536	1572	1612	1644	1669	1695	1726	1757	1788	1824
	51"h x 48"w	1456	1549	1590	1626	1667	1698	1724	1749	1781	1812	1842	1878
	66"h x 48"w	1523	1639	1690	1735	1788	1826	1858	1891	1929	1967	2007	2052
		Gr.12	Gr.13	Gr.13	Gr.15	Gr.16	Gr.16	Gr.18	Gr.19	Gr.20			
C	Contrast Upholstery												
	- Center Divide												
	48"h x 48"w	1865	1916	1969	2020	2072	2123	2175	2226	2278			
	51"h x 48"w	1920	1971	2023	2074	2126	2177	2230	2281	2333			
	66"h x 48"w	2103	2168	2232	2297	2361	2426	2489	2554	2618			
		Panel 2	Panel 2	Panel 2	Panel 2	Panel 2	Panel 2	Panel 2	Panel 2	Panel 2	Panel 2	Panel 2	Panel 2
		COM	Gr.1	Gr.2	Gr.3	Gr.4	Gr.5	Gr.6	Gr.7	Gr.8	Gr.9	Gr.10	Gr.11
C	Contrast Upholstery												
	- Center Divide												
	48"h x 48"w	0	42	60	77	95	109	121	132	146	160	174	190
	51"h x 48"w	0	42	60	77	95	109	121	132	146	160	174	190
	66"h x 48"w	0	52	60	77	95	109	121	132	146	160	174	190
		Gr.12	Gr.13	Gr.13	Gr.15	Gr.16	Gr.16	Gr.18	Gr.19	Gr.20			
C	Contrast Upholstery												
	- Center Divide												
	48"h x 48"w	209	232	255	278	302	325	348	371	394			
	51"h x 48"w	209	232	255	278	302	325	348	371	394			
	66"h x 48"w	209	232	255	278	302	325	348	371	394			



tables

Bevy Occasional Tables	314
Bevy Pedestal Work Tables	324
Bevy Work Leg Tables	334
Borough Tables	344
Cesto Tables	348
Artifort Compass Tables	354
Fractals Nook	358
Freehand	362
Havn Tables	370
Mari-Sol	376
Rec	382
Sly	394

bevy occasional tables

features

Bevy is a dynamic table platform that enables endless configuration. Various heights and sizes give people the ability to work in many ways in a single space. Task tables at lounge height used for personal refuge support work with personal devices. Coffee or occasional tables with sofas encourage positive encounters in the work environment for social interactions.



dimensions

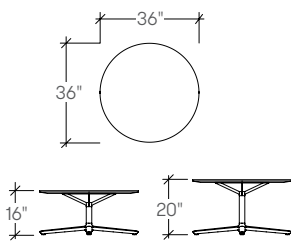

Bevy Round Coffee Table
(STETR)

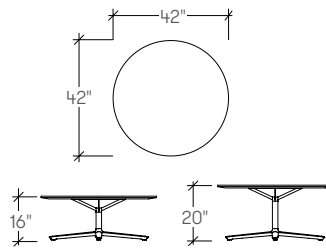

Bevy Round Coffee Table
(STETR)

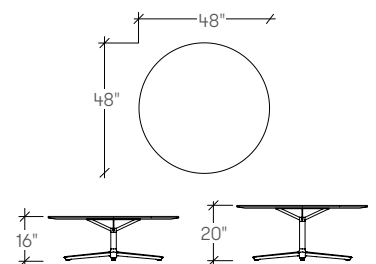

Bevy Round Coffee Table
(STETR)

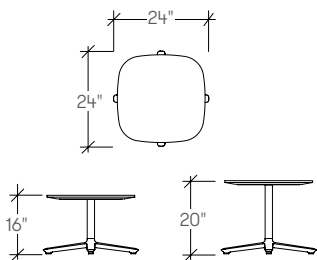

Bevy Square Occasional Table
(STETS)

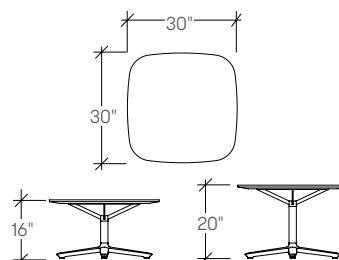

Bevy Square Occasional Table
(STETS)

dimensions

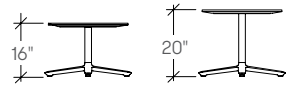
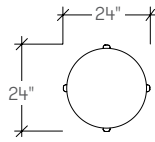

Bevy Round Occasional Table
(STETC)

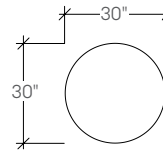

Bevy Round Occasional Table
(STETC)

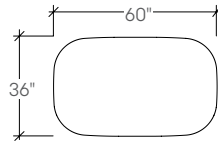

Bevy Rectangular Coffee Y Pedestal Table
(STETG)

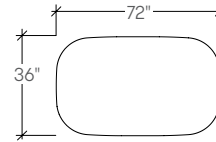

Bevy Rectangular Coffee Y Pedestal Table
(STETG)

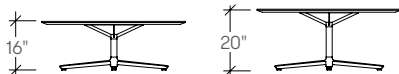
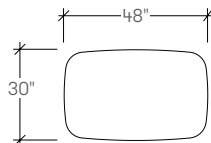

Bevy Rectangular Coffee Table
(STETT)

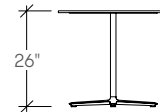
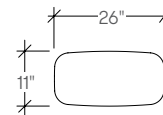

Bevy Rectangular Task Table
(STETF)

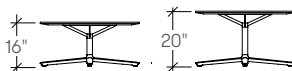
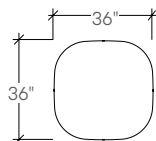

Bevy Square Coffee Table
(STETQ)

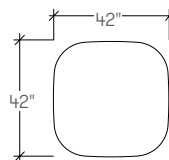

Bevy Square Coffee Table
(STETQ)

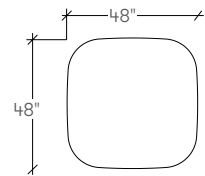

Bevy Square Coffee Table
(STETQ)

bevy occasional tables

planning

With various top sizes, surface materials and base finishes, Bevy offers true personalization of any scenario requiring tables.

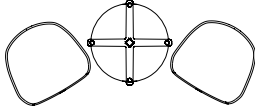

30" Round Occasional Pedestal Table, 20" High

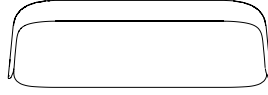

60" x 36" Occasional Table, Y-Leg Base 16" High

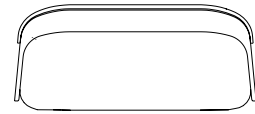

48" x 30" Occasional Table, 16" High

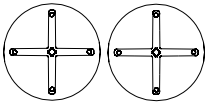

24" Round Occasional Pedestal Table, 20" High

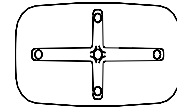
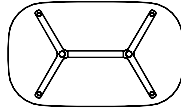

24" x 24" Occasional Table, 20" High

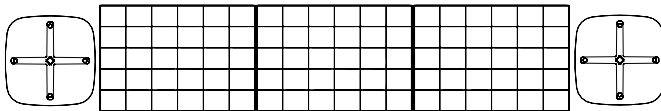

30" x 30" Occasional Table, 16" High

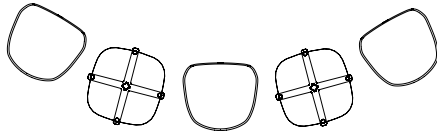

24" x 24" Occasional Table, 20" High

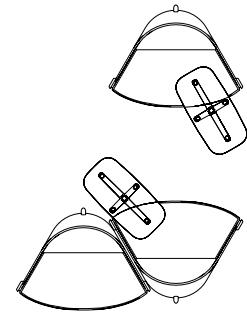

Bevy Task Table

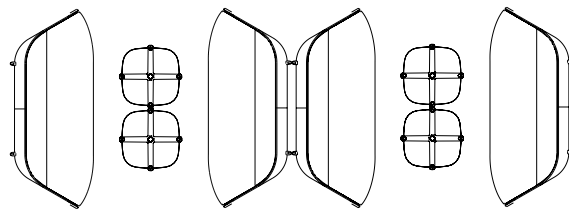

24" x 24" Occasional Table, 20" High

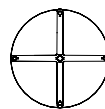
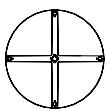
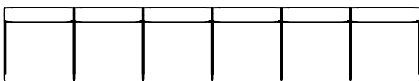

36" Round Occasional Table, 20" High

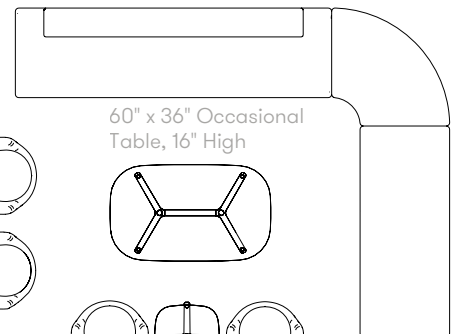

60" x 36" Occasional Table, 16" High

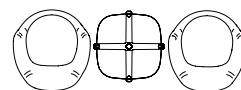
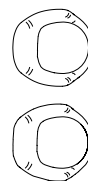

24" x 24" Occasional Table, 20" High

specification example

Bevy permits a wide range of combinations that vary dependent of the configuration specified. The following demonstrates the order that must be selected.

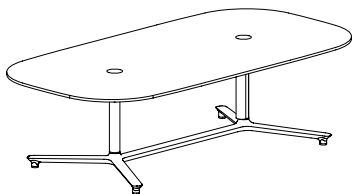

When a cut out is specified on Bevy Tables, a cable manager will be included to route power down the table leg.

POWER UNITS SOLD SEPARATELY

Steps involved in specifying Bevy Occasional Tables

Select configuration
 Select top size
 Select height
 Select power cut out
 Select top surface finish
 Select base finish

Example:

STETK
 STETKG
 STETKG26
 STETKG26N
 STETKG26NMV
 STETKG26NMVC9

STETF bevy rectangular task table

Product Options

Top Size	Height	Surface Finish	Edge Trim Style	Base Finish
A 26" Wide x 11" Deep / 66cm x 28cm	26 26" / 66cm	Studio Foundation Laminate Studio Veneer Solid Surface Glass	G Flat Edge H Knife Edge	C9 Polished Aluminum Fundamental Paint Fashion Paint

Note The column on the Bevy occasional tables is Chrome (C6)
 For Polished Aluminum, add \$0
 For Fundamental Paint, add \$41
 For Fashion Paint, add \$64
 Laminate and Veneer tops always feature a Knife Edge
 Glass and Solid Surface tops always feature a Flat Edge



	Price			
	Studio Foundation Laminate	Studio Veneer	Solid Surface	Glass
A 26" w x 11" d x 26" h / 66cm x 28cm x 66cm	1197	1691	1732	1866

STETC bevy round occasional table

Product Options

Top Size	Height	Power Cut Out	Surface Finish	Edge Trim Style	Base Finish
A 24" Dia / 61cm	16 16" / 41cm	N No Cut Out	Studio Foundation Laminate	G Flat Edge	C9 Polished Aluminum
B 30 Dia / 76cm	20 20" / 51cm	D Power Cut Out for Single Round Power Bump	Studio Veneer Solid Surface Glass	H Knife Edge	Fundamental Paint Fashion Paint

Note The column on the Bevy occasional tables is Chrome (C6)
 For Power Cut Out for Single Round Power Bump (D), add \$232
 For Power Cut Out for Round Power Bump (D) only available for (B) 30" dia top size
 For Polished Aluminum, add \$0
 For Fundamental Paint, add \$41
 For Fashion Paint, add \$64
 Laminate and Veneer tops always feature a Knife Edge
 Glass and Solid Surface tops always feature a Flat Edge
 POWER UNITS SOLD SEPARATELY



	Price			
	Studio Foundation Laminate	Studio Veneer	Solid Surface	Glass
A 24" Dia x 16" High / 61cm x 41cm, Without Cut Out	1197	1837	2080	2213
A 24" Dia x 20" High / 61cm x 51cm, Without Cut Out	1223	1864	2104	2239
B 30" Dia x 16" High / 76cm x 41cm, Without Cut Out	1304	1946	2267	2640
B 30" Dia x 20" High / 76cm x 51cm, Without Cut Out	1332	1973	2320	2669



STETS bevy square occasional table

Product Options

Style	Height	Power Cut Out	Surface Finish	Edge Trim Style	Base Finish
A 24" Wide x 24" Deep / 61cm x 61cm	16 16" / 41cm 20 20" / 51cm	N No Cut Out D Power Cut Out for Single Round Power Bump	Studio Foundation Laminate Studio Veneer Solid Surface Glass	G Flat Edge H Knife Edge	C9 Polished Aluminum Fundamental Paint Fashion Paint

Note The column on the Bevy occasional tables is Chrome (C6)
 For Power Cut Out for Single Round Power Bump (D) , add \$232
 For Power Cut Out for Round Power Bump (D) only available for (B) 30" dia top size
 For Polished Aluminum, add \$0
 For Fundamental Paint, add \$41
 For Fashion Paint, add \$64
 Laminate and Veneer tops always feature a Knife Edge
 Glass and Solid Surface tops always feature a Flat Edge
POWER UNITS SOLD SEPARATELY

Price

		Studio			
		Foundation	Studio Veneer	Solid Surface	Glass
		Laminate			
	A 24" w x 24" d x 16" h / 61cm x 61cm x 41cm, Without Cut Out	1197	1837	2080	2213
	A 24" w x 24" d x 20" h / 61cm x 61cm x 51cm, Without Cut Out	1223	1864	2104	2239
	B 30" w x 30" d x 16" h / 76cm x 76cm x 41cm, Without Cut Out	1304	1946	2267	2640
	B 30" w x 30" d x 20" h / 76cm x 76cm x 51cm, Without Cut Out	1332	1973	2320	2669

STETR bevy round coffee table

Product Options

Top Size	Height	Power Cut Out	Surface Finish	Edge Trim Style	Base Finish
C 36" Dia / 91cm	16 16" / 41cm	N No Cut Out	Studio Foundation Laminate	G Flat Edge	C9 Polished Aluminum
D 42" Dia / 107cm	20 20" / 51cm	D Power Cut Out for Single Round Power Bump	Studio Veneer	H Knife Edge	Fundamental Paint
E 48" Dia / 122cm			Solid Surface		Fashion Paint
			Glass		

Note The column on the Bevy occasional tables is Chrome (C6)
 For Power Cut Out for Single Round Power Bump (D), add \$23 for Laminate and Veneer top surfaces
 add \$46 for Solid Surface and Glass top surfaces

For Polished Aluminum, add \$0
 For Fundamental Paint, add \$41
 For Fashion Paint, add \$64

Laminate and Veneer tops always feature a Knife Edge
 Glass and Solid Surface tops always feature a Flat Edge

POWER UNITS SOLD SEPARATELY

		Price				
		Leather	Studio Foundation Laminate	Studio Veneer	Solid Surface	Glass
	C 36" Dia x 16" High / 91cm x 41cm, Without Cut Out	1545	1598	2937	3470	3577
	C 36" Dia x 20" High / 91cm x 51cm x 51cm, Without Cut Out	1572	1624	2961	3522	3628
	D 42" Dia x 16" High / 107cm x 41cm, Without Cut Out	1812	1866	3204	3871	3978
	D 42" Dia x 20" High / 107cm x 51cm, Without Cut Out	1837	1892	3229	3922	4029
	E 48" Dia x 16" High / 122cm x 41cm, Without Cut Out	2080	2133	3470	4407	4512
	E 48" Dia x 20" High / 122cm x 51cm, Without Cut Out	2104	2159	3496	4458	4563



STETQ bevy square coffee table

Product Options

Top Size	Height	Power Cut Out	Surface Finish	Edge Trim Style	Base Finish
C 36" Wide x 36" Deep / 91cm x 91cm	16 16" / 41cm	N No Cut Out	Studio Foundation Laminate	G Flat Edge	C9 Polished Aluminum Fundamental Paint Fashion Paint
	20 20" / 51cm	D Power Cut Out for Single Round Power Bump	Studio Veneer Solid Surface Glass	H Knife Edge	
D 42" Wide x 42" Deep / 107cm x 107cm					
E 48" Wide x 48" Deep / 122cm x 122cm					

Note The column on the Bevy occasional tables is Chrome (C6)
 For Power Cut Out for Single Round Power Bump (D), add \$23 for Laminate and Veneer top surfaces
 add \$46 for Solid Surface and Glass top surfaces

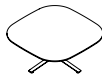
For Polished Aluminum, add \$0
 For Fundamental Paint, add \$41
 For Fashion Paint, add \$64
 Laminate and Veneer tops always feature a Knife Edge
 Glass and Solid Surface tops always feature a Flat Edge
POWER UNITS SOLD SEPARATELY

		Price			
		Studio			
		Foundation			
		Laminate	Studio Veneer	Solid Surface	Glass
	C 36" w x 36" d x 16" h / 91cm x 91cm x 41cm, Without Cut Out	1598	2937	3470	3577
	C 36" w x 36" d x 20" h / 91cm x 91cm x 51cm, Without Cut Out	1624	2961	3522	3628
	D 42" w x 42" d x 16" h / 107cm x 107cm x 41cm, Without Cut Out	1866	3204	3871	3978
	D 42" w x 42" d x 20" h / 107cm x 107cm x 41cm, Without Cut Out	1892	3229	3922	4029
	E 48" w x 48" d x 16" h / 122cm x 122cm x 41cm, Without Cut Out	2133	3470	4407	4512
	E 48" w x 48" d x 20" h / 122cm x 122cm x 51cm, Without Cut Out	2159	3496	4458	4563

STETT bevy rectangular coffee table

Product Options

Top Size	Height	Power Cut Out	Surface Finish	Edge Trim Style	Base Finish
F 48" Wide x 30" Deep / 122cm x 76cm	16 16" / 41cm	N No Cut Out	Studio Foundation Laminate	G Flat Edge	C9 Polished Aluminum
	20 20" / 51cm	D Power Cut Out for Single Round Power Bump	Studio Veneer Solid Surface Glass	H Knife Edge	Fundamental Paint Fashion Paint

Note The column on the Bevy occasional tables is Chrome (C6)
 For Power Cut Out for Single Round Power Bump (D), add \$23 for Laminate and Veneer top surfaces
 add \$46 for Solid Surface and Glass top surfaces

For Polished Aluminum, add \$0

For Fundamental Paint, add \$41

For Fashion Paint, add \$64

Laminate and Veneer tops always feature a Knife Edge

Glass and Solid Surface tops always feature a Flat Edge

POWER UNITS SOLD SEPARATELY

Price



F 48" w x 30" d x 16" h / 122cm x 76cm x 41cm, Without Cut Out



F 48" w x 30" d x 20" h / 122cm x 76cm x 51cm, Without Cut Out

	Studio Foundation Laminate	Studio Veneer	Solid Surface	Glass
F 48" w x 30" d x 16" h / 122cm x 76cm x 41cm, Without Cut Out	1792	2929	3221	3678
F 48" w x 30" d x 20" h / 122cm x 76cm x 51cm, Without Cut Out	1817	2955	3272	3729

STETG bevy rectangular coffee y pedestal table

Product Options

Top Size	Height	Power Cut Out	Surface Finish	Edge Trim Style	Base Finish
G 60" Wide x 36" Deep / 152cm x 91cm	16 16" / 41cm	N No Cut Out	Studio Foundation Laminate	G Flat Edge	C9 Polished Aluminum
H 72" Wide x 36" Deep / 183cm x 91cm	20 20" / 51cm	E Power Cut Out for Dual Round Power Bump	Studio Veneer	H Knife Edge	Fundamental Paint
		Z Power Cut Out for Dual Rectangular Power Core	Solid Surface		Fashion Paint
			Glass		

Note The column on the Bevy occasional tables is Chrome (C6)
 For Power Cut Out for Single Round Power Bump (D), add \$23 for Laminate and Veneer top surfaces
 add \$46 for Solid Surface and Glass top surfaces
 For Polished Aluminum, add \$0
 For Fundamental Paint, add \$41
 For Fashion Paint, add \$64
 Laminate and Veneer tops always feature a Knife Edge
 Glass and Solid Surface tops always feature a Flat Edge
POWER UNITS SOLD SEPARATELY



G 60" w x 36" d x 16" h / 152cm x 91cm x 41cm, Without Cut Out
G 60" w x 36" d x 20" h / 152cm x 91cm x 51cm, Without Cut Out



H 72" w x 36" d x 16" h / 183cm x 91cm x 41cm, Without Cut Out
H 72" w x 36" d x 20" h / 183cm x 91cm x 51cm, Without Cut Out

	Price			
	Studio Foundation Laminate	Studio Veneer	Solid Surface	Glass
G 60" w x 36" d x 16" h / 152cm x 91cm x 41cm, Without Cut Out	2840	4126	5189	5399
G 60" w x 36" d x 20" h / 152cm x 91cm x 51cm, Without Cut Out	2905	4192	5255	5465
H 72" w x 36" d x 16" h / 183cm x 91cm x 41cm, Without Cut Out	3234	4652	5451	6120
H 72" w x 36" d x 20" h / 183cm x 91cm x 51cm, Without Cut Out	3299	4715	5517	6185

bevy pedestal work tables

features

Bevy is a dynamic table platform that enables endless configuration. Various heights and sizes give people the ability to work in countless ways in any space. Bevy tables fill many different scenarios and spaces. From occasional to coffee and café, work and personal task tables, to small and larger conference environments, Bevy can be used anywhere. By addressing the diverse needs of various spaces, Bevy allows people to choose how and where they work.



dimensions

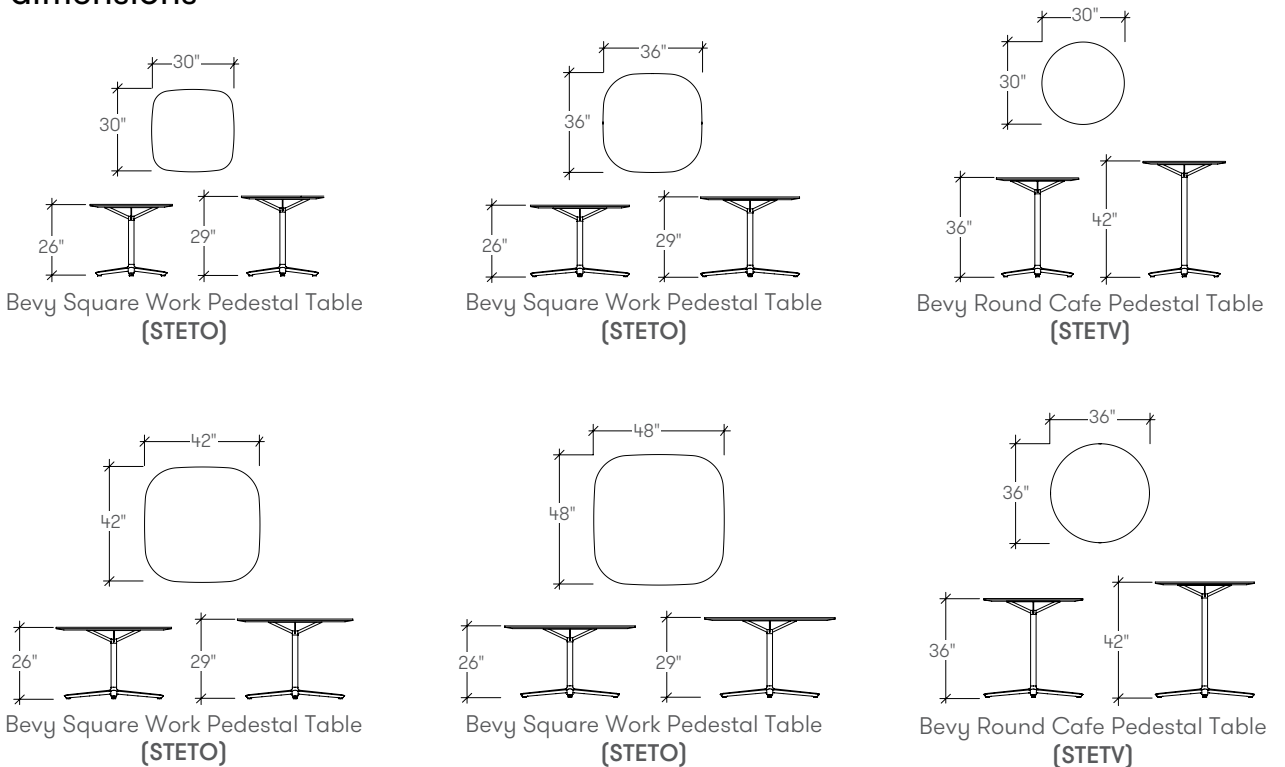

bevy pedestal work tables

dimensions

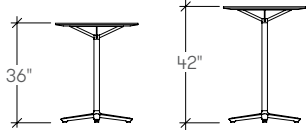
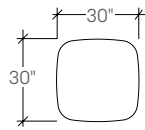

Bevy Square Cafe Pedestal Table
(STETH)

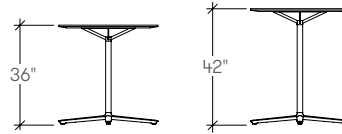
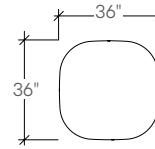

Bevy Square Cafe Pedestal Table
(STETH)

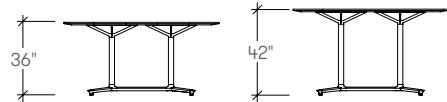
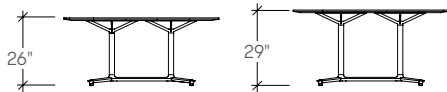
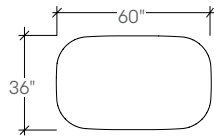

Bevy Rectangular Work Y Pedestal Table
(STETK)

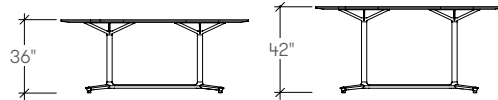
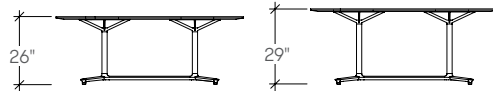
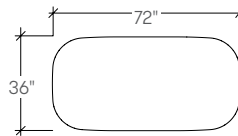

Bevy Rectangular Work Y Pedestal Table
(STETK)

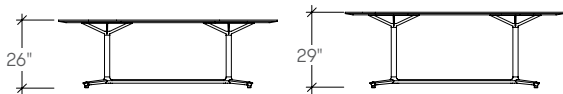
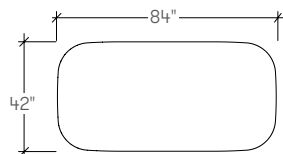

Bevy Rectangular Work Y Pedestal Table
(STETK)

bevy pedestal work tables

dimensions

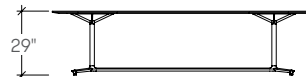
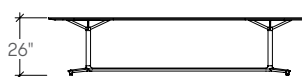
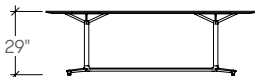
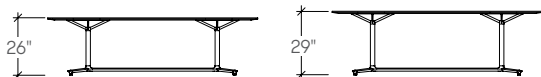
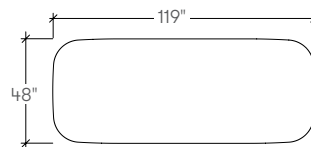
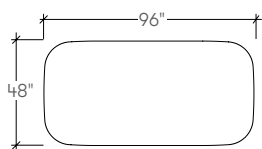

Bevy Rectangular Conference Y Pedestal Table
(STETL)

Bevy Rectangular Conference Y Pedestal Table
(STETL)

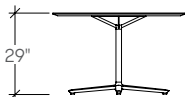
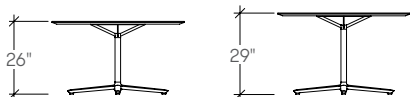
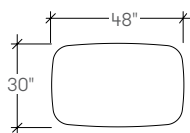

Bevy Booth Pedestal Table
(STETB)

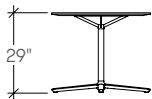
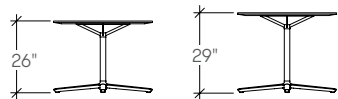
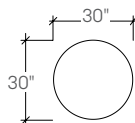

Bevy Round Work Pedestal Table
(STETW)

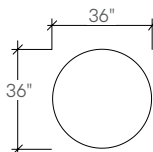

Bevy Round Work Pedestal Table
(STETW)

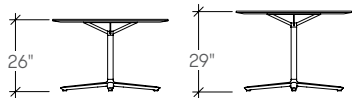
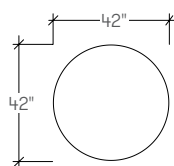

Bevy Round Work Pedestal Table
(STETW)

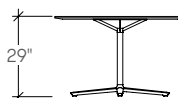
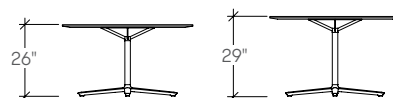
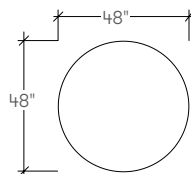

Bevy Round Work Pedestal Table
(STETW)

bevy pedestal work tables

planning

Bevy enables personalization within every configuration through Studio TK's finishes program. Base finishes, including polished aluminum and powder-coat colors, achieve true customization and durability in high-use areas like cafés and dining spaces. Several top sizes in different top surface finishes create an array of choice. A substantial frame under-structure allows for easy wire management, along with providing strength and stability.

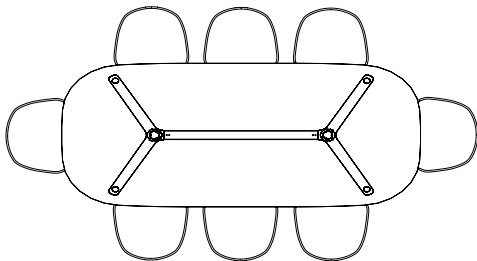

119" x 48" Pedestal Work Table,
Y-Leg Base, 29" High

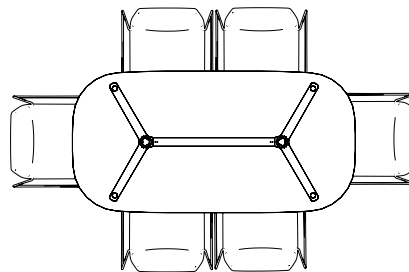

72" x 36" Pedestal Work Table,
Y-Leg Base, 29" High

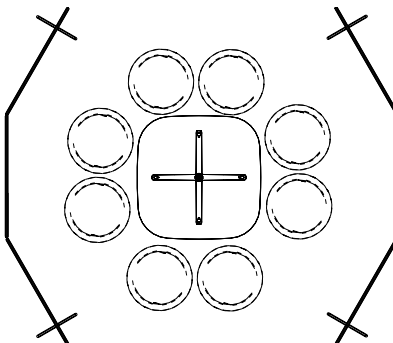

48" x 48" Pedestal Work Table,
Y-Leg Base, 26" High

30" x 30" Pedestal Work Table,
29" High

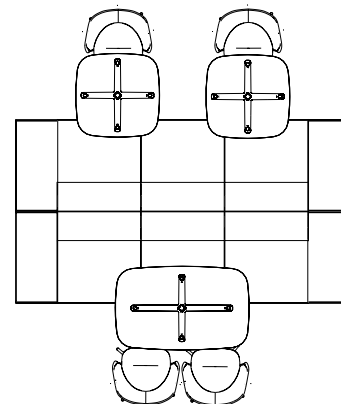

48" x 30" Pedestal Work Table,
29" High

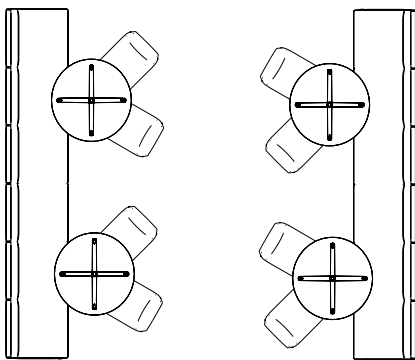

36" Round Pedestal Work
Table, 29" High

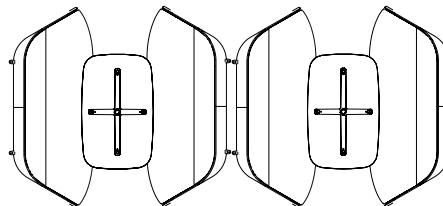

48" x 30" Pedestal Work Table,
Booth Base, 29" High

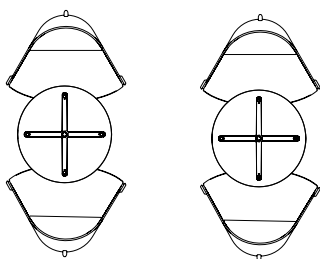

36" Round Pedestal Work
Table, 29" High

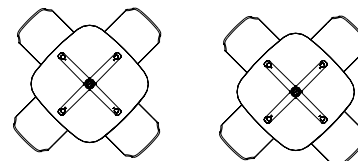

36" x 36" Pedestal Work Table,
Booth Base, 29" High

specification example

Bevy permits a wide range of combinations that vary dependent of the configuration specified. The following demonstrates the order that must be selected.



When a cut out is specified on Bevy Tables a cable manager will be included to route power down the table leg.

POWER UNITS SOLD SEPARATELY

Steps involved in specifying Bevy Work Tables	Example:
Select configuration	STETK
Select top size	STETKG
Select height	STETKG26
Select power cut out	STETKG26N
Select top surface finish	STETKG26NMV
Select base finish	STETKG26NMVC9



STETW bevy round work pedestal table

Product Options

Top Size	Height	Power Cut Out	Surface Finish	Edge Trim Style	Base Finish
B 30" Dia / 76cm	26 26" / 66cm	N No Cut Out	Studio Foundation Laminate	G Flat Edge	C9 Polished Aluminum
C 36" Dia / 91cm	29 29" / 74cm	D Power Cut Out for Single Round Power Bump	Studio Veneer	H Knife Edge	Fundamental Paint
D 42" Dia / 107cm			Solid Surface		Fashion Paint
E 48" Dia / 122cm			Glass		

Note The column on the Bevy pedestal tables is Chrome (C6)
 For Power Cut Out for Single Round Power Bump (D), add \$23 for Laminate and Veneer top surfaces
 add \$46 for Solid Surface and Glass top surfaces
 For Polished Aluminum, add \$0
 For Fundamental Paint, add \$41
 For Fashion Paint, add \$64
 Laminate and Veneer tops always feature a Knife Edge
 Glass and Solid Surface tops always feature a Flat Edge
 POWER UNITS SOLD SEPARATELY

Price

	Studio Foundation	Studio Veneer	Solid Surface	Glass
 B 30" Dia x 26" High / 91cm x 66cm, Without Cut Out	1625	2213	3135	3458
B 30" Dia x 29" High / 91cm x 74cm x 74cm, Without Cut Out	1651	2239	3185	3508
 C 36" Dia x 26" High / 91cm x 66cm, Without Cut Out	1704	2949	3604	3858
C 36" Dia x 29" High / 91cm x 74cm x 74cm, Without Cut Out	1730	2974	3654	3910
D 42" Dia x 26" High / 107cm x 66cm, Without Cut Out	1906	3216	4005	4260
D 42" Dia x 29" High / 107cm x 74cm, Without Cut Out	1931	3241	4058	4311
E 48" Dia x 26" High / 122cm x 66cm, Without Cut Out	2105	3417	4473	4727
E 48" Dia x 29" High / 122cm x 74cm, Without Cut Out	2132	3443	4524	4778



STETO bevy square work pedestal table

Product Options

Top Size	Height	Power Cut Out	Surface Finish	Edge Trim Style	Base Finish
B 30" w x 30" d / 76cm x 76cm	26 26" / 66cm	N No Cut Out	Studio Foundation Laminate	G Flat Edge	C9 Polished Aluminum
C 36" w x 36" d / 91cm x 91cm	29 29" / 74cm	D Power Cut Out for Single Round Power Bump	Studio Veneer Solid Surface Glass	H Knife Edge	Fundamental Paint Fashion Paint
D 42" w x 42" d / 107cm x 107cm					
E 48" w x 48" d / 122cm x 122cm					

Note The column on the Bevy pedestal tables is Chrome (C6)
 For Power Cut Out for Single Round Power Bump (D), add \$23 for Laminate and Veneer top surfaces
 add \$46 for Solid Surface and Glass top surfaces
 For Polished Aluminum, add \$0
 For Fundamental Paint, add \$41
 For Fashion Paint, add \$64
 Laminate and Veneer tops always feature a Knife Edge
 Glass and Solid Surface tops always feature a Flat Edge
POWER UNITS SOLD SEPARATELY

Price

	Studio Foundation Laminate	Studio Veneer	Solid Surface	Glass
 B 30" w x 30" d x 26" h / 76cm x 66cm, Without Cut Out	1625	2213	3135	3458
B 30" w x 30" d x 29" h / 76cm x 74cm, Without Cut Out	1651	2239	3185	3508
 C 36" w x 36" d x 26" h / 91cm x 66cm, Without Cut Out	1704	2949	3604	3858
C 36" w x 36" d x 29" h / 91cm x 74cm, Without Cut Out	1730	2974	3654	3910
D 42" w x 42" d x 26" h / 107cm x 66cm, Without Cut Out	1906	3216	4005	4260
D 42" w x 42" d x 29" h / 107cm x 74cm, Without Cut Out	1931	3241	4058	4311
E 48" w x 48" d x 26" h / 122cm x 66cm, Without Cut Out	2105	3417	4473	4727
E 48" w x 48" d x 29" h / 122cm x 74cm, Without Cut Out	2132	3443	4524	4778

STETV bevy round cafe pedestal table

Product Options

Top Size	Height	Power Cut Out	Surface Finish	Edge Trim Style	Base Finish
B 30" Dia / 76cm	36 36" / 91cm	N No Cut Out	Studio Foundation Laminate	G Flat Edge	C9 Polished Aluminum
C 36" Dia / 91cm	42 42" / 107cm	D Power Cut Out for Single Round Power Bump	Studio Veneer Solid Surface Glass	H Knife Edge	Fundamental Paint Fashion Paint

Note The column on the Bevy pedestal tables is Chrome (C6)
 For Power Cut Out for Single Round Power Bump (D), add \$23 for Laminate and Veneer top surfaces
 add \$46 for Solid Surface and Glass top surfaces

For Polished Aluminum, add \$0
 For Fundamental Paint, add \$41
 For Fashion Paint, add \$64
 Laminate and Veneer tops always feature a Knife Edge
 Glass and Solid Surface tops always feature a Flat Edge
POWER UNITS SOLD SEPARATELY

Price

Studio Foundation	Laminate	Studio Veneer	Solid Surface	Glass
B 30" Dia x 36" High / 76cm x 91cm, Without Cut Out	1759	2414	3238	3558
B 30" Dia x 42" High / 76cm x 107cm, Without Cut Out	1784	2439	3287	3608
C 36" Dia x 36" High / 91cm x 91cm, Without Cut Out	1906	3149	3738	3993
C 36" Dia x 42" High / 91cm x 107cm, Without Cut Out	1931	3175	3789	4043



B 30" Dia x 36" High / 76cm x 91cm, Without Cut Out
B 30" Dia x 42" High / 76cm x 107cm, Without Cut Out



C 36" Dia x 36" High / 91cm x 91cm, Without Cut Out
C 36" Dia x 42" High / 91cm x 107cm, Without Cut Out

STETH bevy square cafe pedestal table

Product Options

Top Size	Height	Power Cut Out	Surface Finish	Edge Trim Style	Base Finish
B 30" w x 30" d / 76cm x 76cm	36 36" / 91cm	N No Cut Out	Studio Foundation Laminate	G Flat Edge	C9 Polished Aluminum
C 36" w x 36" d / 91cm x 91cm	42 42" / 107cm	D Power Cut Out for Single Round Power Bump	Studio Veneer Solid Surface Glass		Fundamental Paint Fashion Paint

Note The column on the Bevy pedestal tables is Chrome (C6)
 For Power Cut Out for Single Round Power Bump (D), add \$23 for Laminate and Veneer top surfaces
 add \$46 for Solid Surface and Glass top surfaces

For Polished Aluminum, add \$0
 For Fundamental Paint, add \$41
 For Fashion Paint, add \$64
 Laminate and Veneer tops always feature a Knife Edge
 Glass and Solid Surface tops always feature a Flat Edge
POWER UNITS SOLD SEPARATELY

Price

Studio Foundation	Laminate	Studio Veneer	Solid Surface	Glass
B 30" w x 30" d x 36" h / 76cm x 76cm x 91cm, Without Cut Out	1759	2414	3238	3558
B 30" w x 30" d x 42" h / 76cm x 76cm x 107cm, Without Cut Out	1784	2439	3287	3608
C 36" w x 36" d x 36" h / 91cm x 91cm x 91cm, Without Cut Out	1906	3149	3738	3993
C 36" w x 36" d x 42" h / 91cm x 91cm x 107cm, Without Cut Out	1931	3175	3789	4043



B 30" w x 30" d x 36" h / 76cm x 76cm x 91cm, Without Cut Out
B 30" w x 30" d x 42" h / 76cm x 76cm x 107cm, Without Cut Out



C 36" w x 36" d x 36" h / 91cm x 91cm x 91cm, Without Cut Out
C 36" w x 36" d x 42" h / 91cm x 91cm x 107cm, Without Cut Out

STETB bevy booth pedestal table

Product Options

Top Size	Height	Power Cut Out	Surface Finish	Edge Trim Style	Base Finish
F 48" Wide x 30" Deep / 122cm x 76cm	26 26" / 66cm	N No Cut Out	Studio Foundation Laminates	G Flat Edge	C9 Polished Aluminum
	29 29" / 74cm	D Power Cut Out for Single Round Power Bump	Studio Veneer Solid Surface Glass	H Knife Edge	Fundamental Paint Fashion Paint

Note The column on the Bevy pedestal tables is Chrome (C6)
 For Power Cut Out for Single Round Power Bump (D), add \$23 for Laminates and Veneer top surfaces
 add \$46 for Solid Surface and Glass top surfaces

For Polished Aluminum, add \$0
 For Fundamental Paint, add \$41
 For Fashion Paint, add \$64
 Laminates and Veneer tops always feature a Knife Edge
 Glass and Solid Surface tops always feature a Flat Edge
POWER UNITS SOLD SEPARATELY

Price



F 48" w x 30" d x 26" h / 122cm x 76cm x 66cm, Without Cut Out
 F 48" w x 30" d x 29" h / 122cm x 76cm x 74cm, Without Cut Out

Studio Foundation Laminates	Studio Veneer	Solid Surface	Glass
1826	2961	3256	3711
1850	2987	3307	3761



STETK bevy rectangular work y pedestal table

Product Options

Top Size	Height	Power Cut Out	Surface Finish	Edge Trim Style	Base Finish
G 60" Wide x 36" Deep / 152cm x 91cm	26 26" / 66cm	N No Cut Out	Studio Foundation Laminate	G Flat Edge	C9 Polished Aluminum Fundamental Paint Fashion Paint
	29 29" / 74cm	E Power Cut Out for Dual Round Power Bump	Studio Veneer Solid Surface	H Knife Edge	
H 72" Wide x 36" Deep / 183cm x 91cm	36 36" / 91cm	Z Power Cut Out for Dual Rectangular Power Core	Glass		
	42 42" / 107cm				
K 84" Wide x 42" Deep / 213cm x 107cm					

Note The column on the Bevy pedestal tables is Chrome (C6)
 For Power Cut Out for Dual Round Power Bump (D), add \$46
 For Power Cut Out for Dual Rectangular Power Core (Z), add \$46
 Back-Painted Glass is only available for 60"w x 36"d (G) and 72"w x 36"d (H) top sizes
 For Polished Aluminum, add \$0
 For Fundamental Paint, add \$41
 For Fashion Paint, add \$64
 Laminate and Veneer tops always feature a Knife Edge
 Glass and Solid Surface tops always feature a Flat Edge
POWER UNITS SOLD SEPARATELY



- G** 60" w x 36" d x 26" h / 152cm x 91cm x 66cm, Without Cut Out
- G** 60" w x 36" d x 29" h / 152cm x 91cm x 74cm, Without Cut Out
- G** 60" w x 36" d x 36" h / 152cm x 91cm x 91cm, Without Cut Out
- G** 60" w x 36" d x 42" h / 152cm x 91cm x 107cm, Without Cut Out
- H** 72" w x 36" d x 26" h / 183cm x 91cm x 66cm, Without Cut Out
- H** 72" w x 36" d x 29" h / 183cm x 91cm x 74cm, Without Cut Out
- H** 72" w x 36" d x 36" h / 183cm x 91cm x 91cm, Without Cut Out
- H** 72" w x 36" d x 42" h / 183cm x 91cm x 107cm, Without Cut Out
- K** 84" w x 42" d x 26" h / 213cm x 107cm x 66cm, Without Cut Out
- K** 84" w x 42" d x 29" h / 213cm x 107cm x 74cm, Without Cut Out

Price

Studio Foundation	Studio Veneer	Solid Surface	Glass
Laminate			
3163	4338	5424	5635
3231	4407	5489	5704
3482	4659	5742	5957
3608	4785	5868	6083
3430	4874	5691	6373
3497	4939	6158	6439
3749	5191	6410	6692
3876	5317	6535	6817
3698	5142	9302	n/a
3751	5196	9355	n/a

STETL bevy rectangular conference y pedestal table

Product Options

Top Size	Height	Power Cut Out	Surface Finish	Edge Trim Style	Base Finish
L 96" Wide x 48" Deep / 244cm x 122cm	26 26" / 66cm	N No Cut Out	Studio Foundation Laminate	G Flat Edge	C9 Polished Aluminum Fundamental Paint Fashion Paint
	29 29" / 74cm	E Power Cut Out for Dual Round Power Bump	Studio Veneer	H Knife Edge	
M 119" Wide x 48" Deep / 305cm x 122cm		Z Power Cut Out for Dual Rectangular Power Core	Solid Surface		

Note The column on the Bevy pedestal tables is Chrome (C6)
 For Power Cut Out for Dual Round Power Bump (D), add \$46
 For Power Cut Out for Dual Rectangular Power Core (Z), add \$46
 Back-Painted Glass is not available on 96" and 119" top sizes
 For Polished Aluminum, add \$0
 For Fundamental Paint, add \$41
 For Fashion Paint, add \$64
 Laminate and Veneer tops always feature a Knife Edge
 Solid Surface tops always feature a Flat Edge
POWER UNITS SOLD SEPARATELY

Price

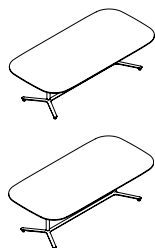

- L 96" w x 48" d x 26" h / 244cm x 122cm x 66cm, Without Cut Out
- L 96" w x 48" d x 29" h / 244cm x 122cm x 74cm, Without Cut Out
- M 119" w x 48" d x 26" h / 305cm x 122cm x 66cm, Without Cut Out
- M 119" w x 48" d x 29" h / 305cm x 122cm x 74cm, Without Cut Out

	Studio Foundation Laminate	Studio Veneer	Solid Surface
L 96" w x 48" d x 26" h / 244cm x 122cm x 66cm, Without Cut Out	3966	5409	11041
L 96" w x 48" d x 29" h / 244cm x 122cm x 74cm, Without Cut Out	4019	5464	11093
M 119" w x 48" d x 26" h / 305cm x 122cm x 66cm, Without Cut Out	4366	5810	11442
M 119" w x 48" d x 29" h / 305cm x 122cm x 74cm, Without Cut Out	4420	5866	11562

bevy work leg tables

features

Bevy is a dynamic table platform that enables endless configuration. A variety of heights and sizes give people the ability to work in a variety of ways in any space. The unique wood-leg version brings a crafted elegance, introducing a more emotional response to otherwise traditionally stagnant environments.



dimensions

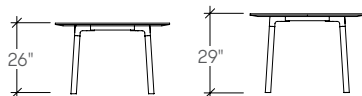
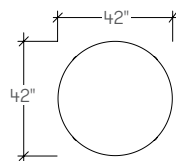

Bevy Round Work Leg Table
(STETJ)

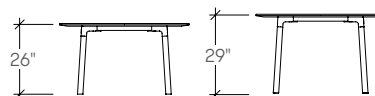
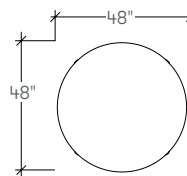

Bevy Round Work Leg Table
(STETJ)

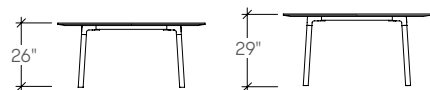
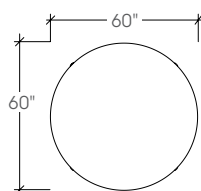

Bevy Round Work Leg Table
(STETJ)

bevy work leg tables

dimensions

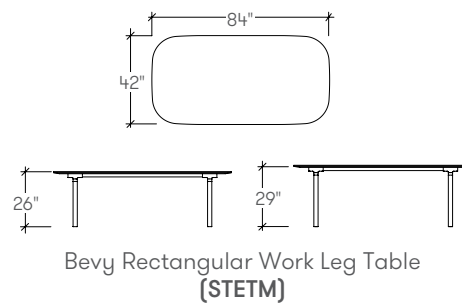
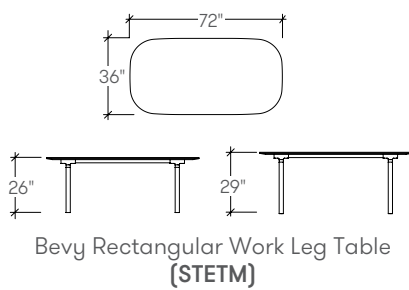
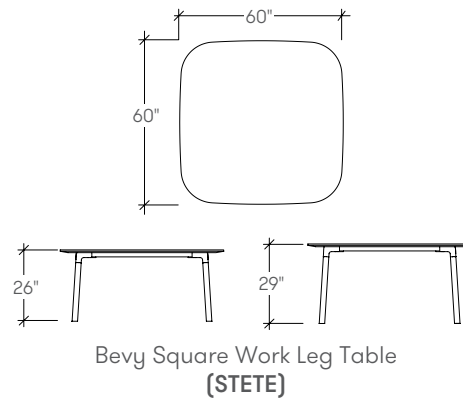
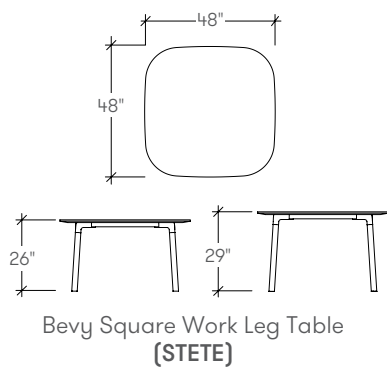
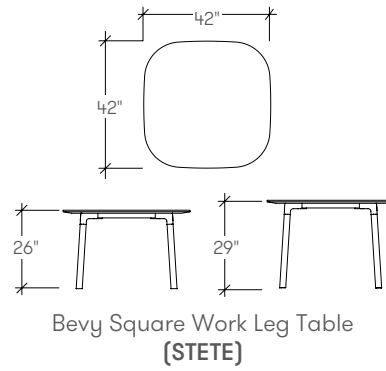
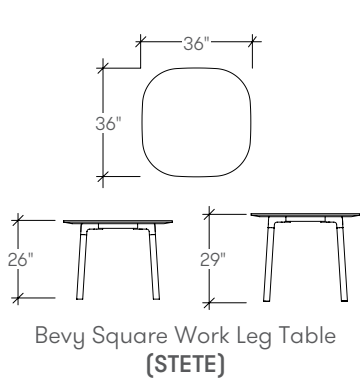

bevy conference leg tables

dimensions

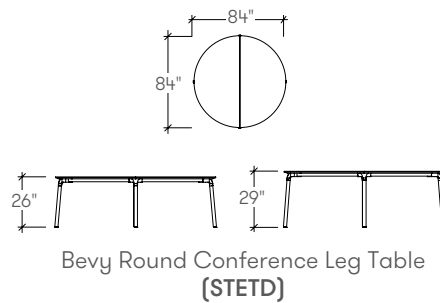
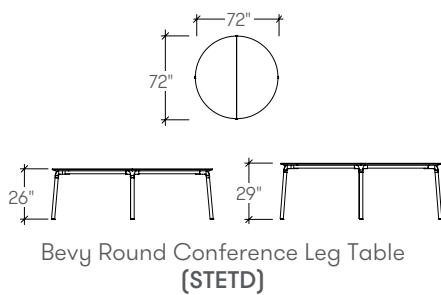
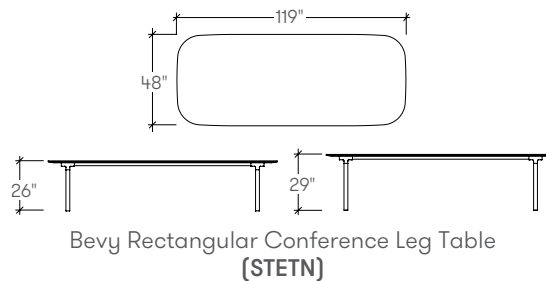
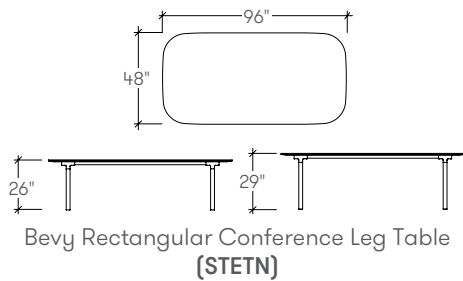

bevy work leg tables

planning

Bevy enables personalization within every configuration through Studio TK's finishes program. The unique wood-leg base is available in a variety of finishes and brings a warmth and elegance to any work, conference or dining environment. Several top sizes in different top surface finishes create an array of choice. A substantial frame under-structure allows for easy wire management, along with providing strength and stability.

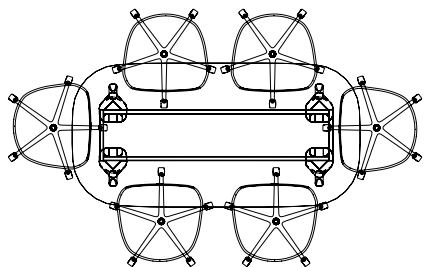

84" x 42" Bevy Leg Table, minimum 6 chairs, Kuskoo Bi 5-Star Base

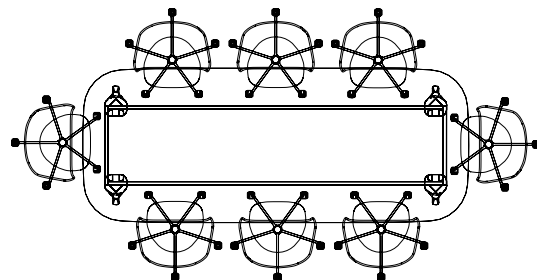

120" x 48" Bevy Leg Table, minimum 8 chairs

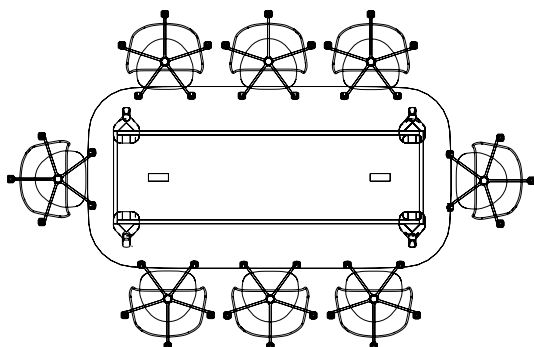

96" x 48" Bevy Leg Table, minimum 8 chairs

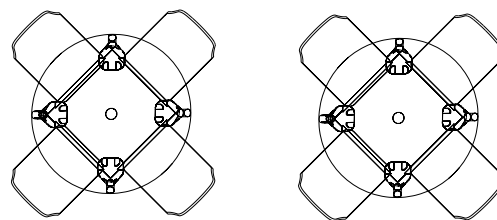

42" Bevy Round Leg Table, maximum 4 chairs, Kuskoo Chair

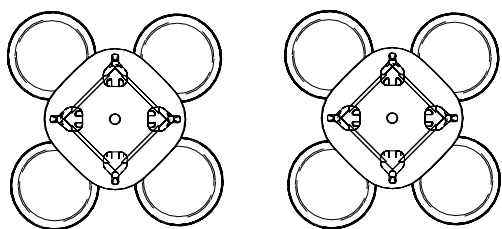

36" x 36" Bevy Leg Table at 26" high, minimum 4 chairs, small Qui Ottoman

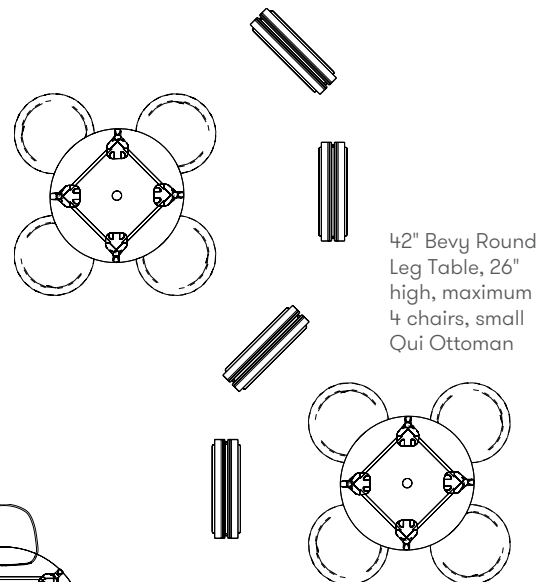

42" Bevy Round Leg Table, 26" high, maximum 4 chairs, small Qui Ottoman

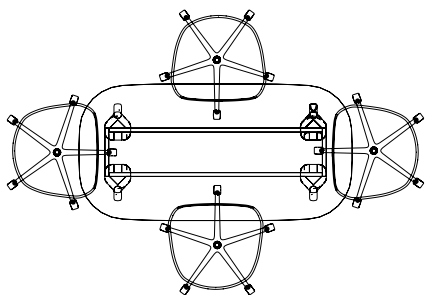

72" x 36" Bevy Leg Table, minimum 4 chairs, Kuskoo Bi 5-Star Base

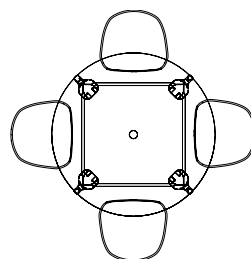

60" Bevy Round Leg Table, minimum 4 chairs, Kuskoo Bi Wood Legs

specification example



Bevy permits a wide range of combinations that vary dependent of the configuration specified. The following demonstrates the order that must be selected.

Steps involved in specifying Bevy Work Leg Tables	Example:
Select configuration	STETM
Select top size	STETMK
Select height	STETMK26
Select power cut out	STETMK26N
Select top surface finish	STETMK26NMV
Select casting finish	STETMK26NMVC9
Select wood leg finish	STETMK26NMVC9BU

When a cut out is specified on Bevy Tables a cable manager will be included to route power down the table leg.

POWER UNITS SOLD SEPARATELY

STETJ bevy round work leg table

Product Options

Top Size	Height	Power Cut Out	Surface Finish	Edge Trim Style	Base Finish	Leg Finish
D 42" Dia / 107cm	26 26" / 66cm	N No Cut Out	Studio Foundation Laminate	G Flat Edge H Knife Edge	C9 Polished Aluminum	BU Basque White Oak
	29 29" / 74cm	D Power Cut Out for Single Round Power Bump				
E 48" Dia / 122cm			Studio Veneer		Fundamental Paint	DY Cocoa Brown
R 60" Dia / 152cm			Solid Surface		Fashion Paint	DV Sierra
			Glass			DZ Truffle
						NK Natural Oak

Note For Power Cut Out for Single Round Power Bump (D), add \$35
 Back-Painted Glass top surface is not available for 60" dia (R) top size
 For Polished Aluminum, add \$0
 For Fundamental Paint, add \$41
 For Fashion Paint, add \$64
 Laminate and Veneer tops always feature a Knife Edge
 Glass and Solid Surface tops always feature a Flat Edge
 POWER UNITS SOLD SEPARATELY

Price

Studio Foundation	Laminate	Studio Veneer	Solid Surface	Glass
D 42" Dia x 26" High / 107cm x 66cm, Without Cut Out	2787	4032	4634	4742
D 42" Dia x 29" High / 107cm x 74cm, Without Cut Out	2826	4069	4672	4779
E 48" Dia x 26" High / 122cm x 66cm, Without Cut Out	3123	4366	5304	5409
E 48" Dia x 29" High / 122cm x 74cm, Without Cut Out	3161	4405	5341	5447
R 60" Dia x 26" High / 152cm x 66cm, Without Cut Out	3390	5036	7309	n/a
R 60" Dia x 29" High / 152cm x 74cm, Without Cut Out	3428	5073	7347	n/a



D 42" Dia x 26" High / 107cm x 66cm, Without Cut Out
 D 42" Dia x 29" High / 107cm x 74cm, Without Cut Out



E 48" Dia x 26" High / 122cm x 66cm, Without Cut Out
 E 48" Dia x 29" High / 122cm x 74cm, Without Cut Out

R 60" Dia x 26" High / 152cm x 66cm, Without Cut Out
 R 60" Dia x 29" High / 152cm x 74cm, Without Cut Out

STETE bevy square work leg table

Product Options

Top Size	Height	Power Cut Out	Surface Finish	Edge Trim Style	Leg Casting Finish	Leg Finish
C 36" Wide x 36" Deep / 91cm x 91cm	26 26" / 66cm 29 29" / 74cm	N No Cut Out D Power Cut Out for Single Round Power Bump	Studio Foundation Laminate Studio Veneer Solid Surface Glass	G Flat Edge H Knife Edge	C9 Polished Aluminum Fundamental Paint Fashion Paint	BU Basque White Oak DY Cocoa Brown DV Sierra DZ Truffle NK Natural Oak
D 42" Wide x 42" Deep / 107cm x 107cm						
E 48" Wide x 48" Deep / 122cm x 122cm						
R 60" Wide x 60" Deep / 152cm x 152cm						

Note For Power Cut Out for Single Round Power Bump (D), add \$35
 Back-Painted Glass top surface is not available for 60" dia (R) top size
 For Polished Aluminum, add \$0
 For Fundamental Paint, add \$41
 For Fashion Paint, add \$64
 Laminate and Veneer tops always feature a Knife Edge
 Glass and Solid Surface tops always feature a Flat Edge
POWER UNITS SOLD SEPARATELY

Price

	Studio Foundation			
	Laminate	Studio Veneer	Solid Surface	Glass
C 36" w x 36" d x 26" h / 91cm x 91cm x 66cm, Without Cut Out	2455	3698	4298	4407
C 36" w x 36" d x 29" h / 91cm x 91cm x 74cm, Without Cut Out	2492	3735	4336	4444
D 42" w x 42" d x 26" h / 107cm x 107cm x 66cm, Without Cut Out	2787	4032	4634	4742
D 42" w x 42" d x 29" h / 107cm x 107cm x 74cm, Without Cut Out	2826	4069	4672	4779
E 48" w x 48" d x 26" h / 122cm x 122cm x 66cm, Without Cut Out	3123	4366	5304	5409
E 48" w x 48" d x 29" h / 122cm x 122cm x 74cm, Without Cut Out	3161	4407	5341	5447
R 60" w x 60" d x 26" h / 152cm x 152cm x 66cm, Without Cut Out	3390	5036	7309	n/a
R 60" w x 60" d x 29" h / 152cm x 152cm x 74cm, Without Cut Out	3428	5073	7347	n/a

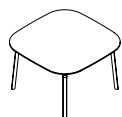
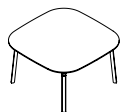

- C** 36" w x 36" d x 26" h / 91cm x 91cm x 66cm, Without Cut Out
- C** 36" w x 36" d x 29" h / 91cm x 91cm x 74cm, Without Cut Out
- D** 42" w x 42" d x 26" h / 107cm x 107cm x 66cm, Without Cut Out
- D** 42" w x 42" d x 29" h / 107cm x 107cm x 74cm, Without Cut Out
- E** 48" w x 48" d x 26" h / 122cm x 122cm x 66cm, Without Cut Out
- E** 48" w x 48" d x 29" h / 122cm x 122cm x 74cm, Without Cut Out
- R** 60" w x 60" d x 26" h / 152cm x 152cm x 66cm, Without Cut Out
- R** 60" w x 60" d x 29" h / 152cm x 152cm x 74cm, Without Cut Out

STEMM bevy rectangular work leg table

Product Options

Top Size	Height	Power Cut Out	Surface Finish	Edge Trim Style	Leg Casting Finish	Leg Finish
H 72" Wide x 36" Deep / 183cm x 91cm	26 26" / 66cm	N No Cut Out	Studio Foundation Laminate	G Flat Edge	C9 Polished Aluminum	BU Basque White Oak
	29 29" / 74cm	E Power Cut Out for Dual Round Power Bump	Studio Veneer	H Knife Edge		DY Cocoa Brown
K 84" Wide x 42" Deep / 213cm x 107cm		Z Power Cut Out for Dual Rectangular Power Core	Solid Surface		Fundamental Paint	DV Sierra
			Glass		Fashion Paint	DZ Truffle
						NK Natural Oak

Note For Power Cut Out for Dual Round Power Bump (E), add \$46
 For Power Cut Out for Dual Rectangular Power Core (Z), add \$46
 Back-Painted Glass top surface is not available for 84"w x 42"d (K) top size
 For Polished Aluminum, add \$0
 For Fundamental Paint, add \$41
 For Fashion Paint, add \$64
 Laminate and Veneer tops always feature a Knife Edge
 Glass and Solid Surface tops always feature a Flat Edge
POWER UNITS SOLD SEPARATELY

Price

	Studio Foundation Laminate	Studio Veneer	Solid Surface	Glass
H 72" w x 36" d x 26" h / 183cm x 91cm x 66cm, Without Cut Out	3001	4807	5878	6346
H 72" w x 36" d x 29" h / 183cm x 91cm x 74cm, Without Cut Out	3042	4849	5918	6386
K 84" w x 42" d x 26" h / 213cm x 107cm x 66cm, Without Cut Out	3671	5478	8955	n/a
K 84" w x 42" d x 29" h / 213cm x 107cm x 74cm, Without Cut Out	3711	5516	8995	n/a

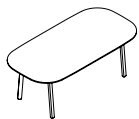

STETN bevy rectangular conference leg table

Product Options

Top Size	Height	Power Cut Out	Surface Finish	Edge Trim Style	Leg Casting Finish	Leg Finish
L 96" Wide x 48" Deep / 244cm x 122cm	26 26" / 66cm	N No Cut Out	Studio Foundation Laminate	G Flat Edge	C9 Polished Aluminum	BU Basque White Oak
	29 29" / 74cm	E Power Cut Out for Dual Round Power Bump	Studio Veneer	H Knife Edge		DY Cocoa Brown
M 119" Wide x 48" Deep / 305cm x 122cm		Z Power Cut Out for Dual Rectangular Power Core	Solid Surface		Fundamental Paint	DV Sierra
					Fashion Paint	DZ Truffle
						NK Natural Oak

Note For Power Cut Out for Dual Round Power Bump (E), add \$46
 For Power Cut Out for Dual Rectangular Power Core (Z), add \$46
 Back-Painted Glass top surface is not available for 96" and 119" top sizes
 For Polished Aluminum, add \$0
 For Fundamental Paint, add \$41
 For Fashion Paint, add \$64
 Laminate and Veneer tops always feature a Knife Edge
 Solid Surface tops always feature a Flat Edge
POWER UNITS SOLD SEPARATELY

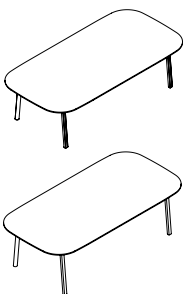

- L 96" w x 48" d x 26" h / 244cm x 122cm x 66cm, Without Cut Out
- L 96" w x 48" d x 29" h / 244cm x 122cm x 74cm, Without Cut Out
- M 119" w x 48" d x 26" h / 305cm x 122cm x 66cm, Without Cut Out
- M 119" w x 48" d x 29" h / 305cm x 122cm x 74cm, Without Cut Out

Price

Studio Foundation Laminate	Studio Veneer	Solid Surface
3978	5786	10867
4246	6118	11201
4246	6052	11468
4512	6386	11536

STETD bevy round conference leg table

Product Options

Top Size	Height	Power Cut Out	Surface Finish	Edge Trim Style	Leg Casting Finish	Leg Finish
S 72" dia / 183cm	26 26" / 66cm	N No Cut Out	Studio Foundation Laminate	G Flat Edge	C9 Polished Aluminum	BU Basque White Oak
T 84" dia / 213cm	29 29" / 74cm	E Power Cut Out for Dual Round Power Bump	Studio Veneer	H Knife Edge	Fundamental Paint	DY Cocoa Brown
		Z Power Cut Out for Dual Rectangular Power Core			Fashion Paint	DV Sierra
						DZ Truffle
						NK Natural Oak

Note For either Dual Round Power Bump or Dual Rectangular Power Core Cut Out, add \$35
 For Fundamental Paint Finish, add \$41
 For Fashion Paint Finish, add \$58
 Laminate and Veneer tops always feature a Knife Edge
 POWER UNIT SOLD SEPARATELY

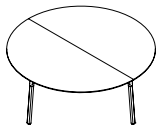

- S 72" dia x 26" h / 183cm x 66cm, No Cut Out
- S 72" dia x 29" h / 183cm x 74cm, No Cut Out
- T 84" dia x 26" h / 213cm x 66cm, No Cut Out
- T 84" dia x 29" h / 213cm x 74cm, No Cut Out

Price

Studio Foundation Laminate	Studio Veneer
4747	7513
4784	7552
5503	8271
5540	8308

borough tables

features

Borough is a collection of hospitality oriented elements set to enhance our daily experience as we journey between our destinations.

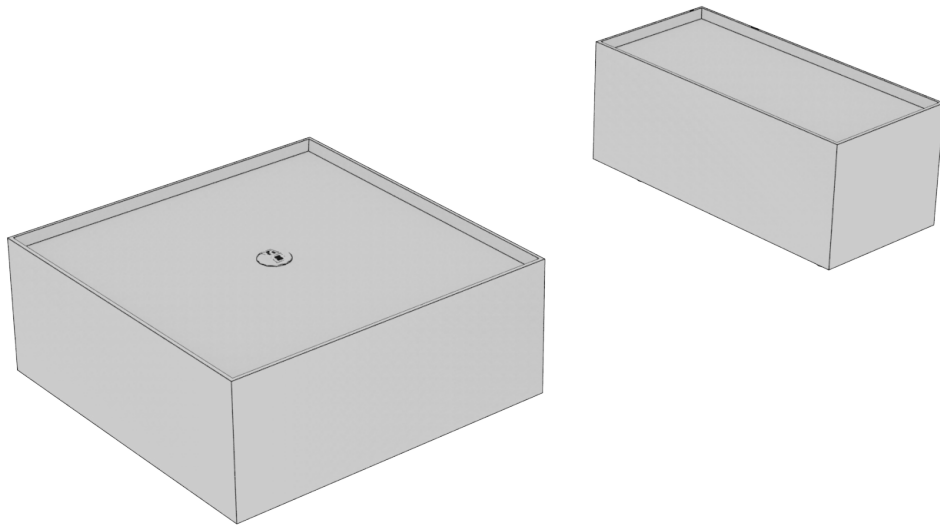

dimensions

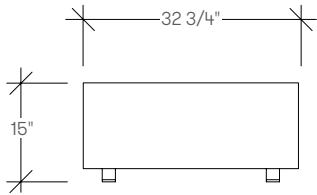

Borough Table, Rectangle
(STHTA)

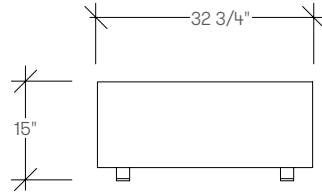

Borough Table, Square
(STHTB)

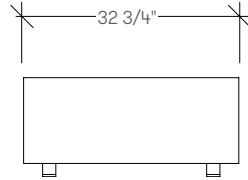
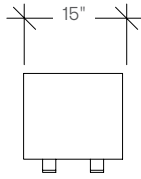

single round power bump



1 simplex,
2 USB-A

Power available in Ebony or Storm White coordinates. 10 ft. North American plug.
POWER UNITS SOLD SEPARATELY [refer to Power Accessory STYD]

STHTA **borough table, rectangle**

Product Options

Power Cut Out	Surface Finish	Edge Trim Style	Wood Base Finish
N No Cut Out	Studio Foundation Laminate	G Flat Edge	BU Basque White Oak
D Power Cut Out for Single Round Power Bump	Studio Veneer Glass		NK Natural Oak DY Cocoa Brown DV Sierra DZ Truffle

Note - For Power Cut Out for Single Round Power Bump (D) is selected, add \$46
- POWER UNITS SOLD SEPARATELY (refer to Power Accessory STYD)

Price



	Studio Foundation Laminate	Studio Veneer	Glass
N No Cut Out	2774	2774	3965
D Power Cut Out	2822	2822	4014

STHTB **borough table, square**

Product Options

Power Cut Out	Surface Finish	Edge Trim Style	Wood Base Finish
N No Cut Out	Studio Foundation Laminate	G Flat Edge	BU Basque White Oak
D Power Cut Out for Single Round Power Bump	Studio Veneer Glass		NK Natural Oak DY Cocoa Brown DV Sierra DZ Truffle

Note For Power Cut Out for Single Round Power Bump (D) is selected, add \$46
POWER UNITS SOLD SEPARATELY (refer to Power Accessory STYD)

Price

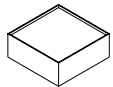

	Studio Foundation Laminate	Studio Veneer	Glass
N No Cut Out	3038	3038	4892
D Power Cut Out	3087	3087	4940

cesto tables

features

Cesto, spanish for 'basket', is a collection of interactive seating and table elements designed to address the dynamic collaborative and social behaviors typical of today's work environment. The lightweight, easily mobile tables allow for people within the office to move pieces around the space at their hearts content. Composed of an upholstered bottom element and a variety of functional tops, this simple collection offers a comprehensive family of furnishings for the new social office landscape.

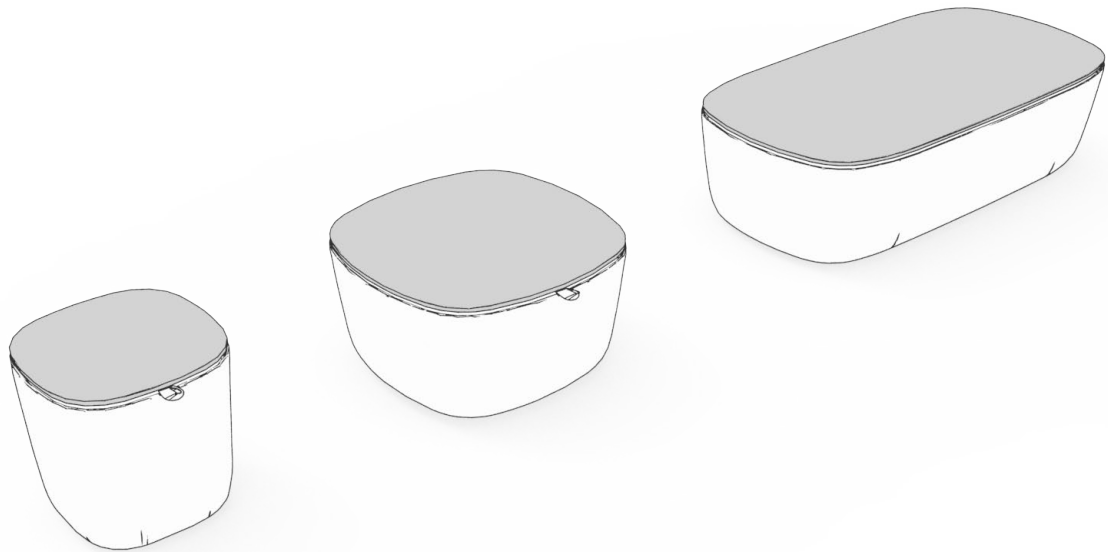

dimensions

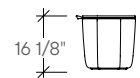
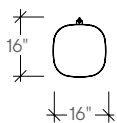

Cesto Side Table,
Knit Base
[STGTA]

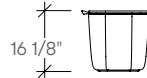
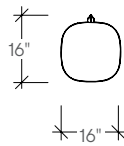

Cesto Side Table,
Fabric Base
[STGTB]

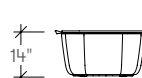
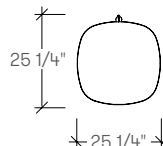

Cesto Coffee Table,
Knit Base
[STGTC]

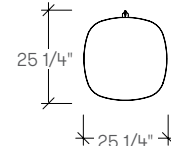

Cesto Coffee Table,
Fabric Base
[STGTD]

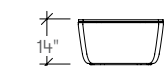
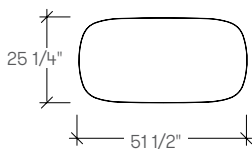

Cesto Rectangular
Coffee Table, Knit Base
[STGTE]

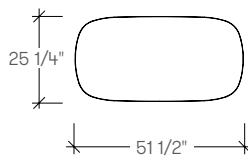

Cesto Rectangular Coffee
Table, Fabric Base
[STGTF]

cesto tables

planning

With various top sizes, surface materials and base finishes, Cesto Tables offers true personalization of any scenario requiring tables.

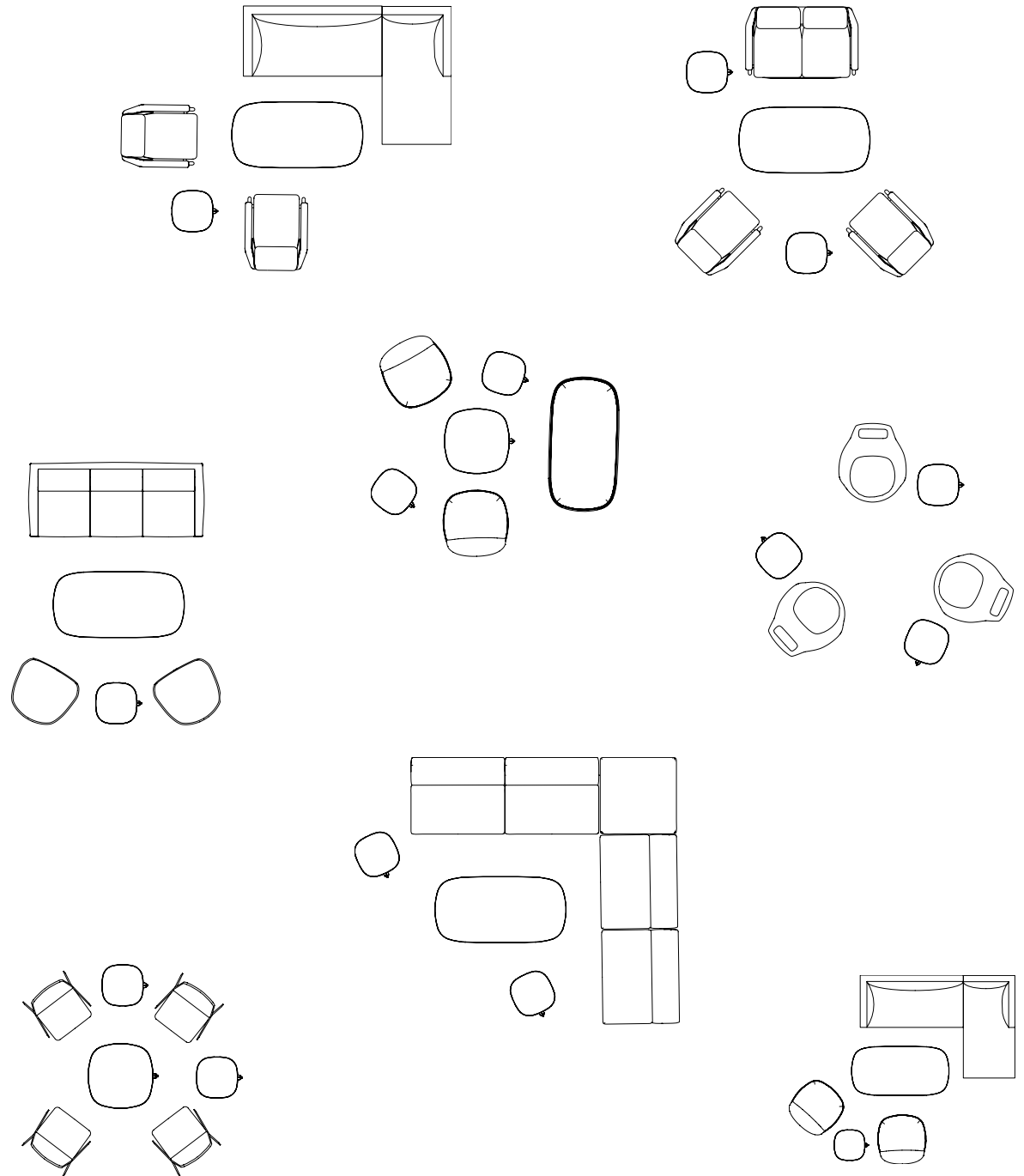

specifying cesto finishes

Cesto Tables permits a wide range of combinations that vary dependent of the configuration specified. The following demonstrates the order that must be selected.

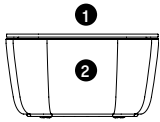

- 1 **Top Surface**
Select top surface finish
- 2 **Base Finish**
Select knit finish or base upholstery

specification example

STGTC Cesto Coffee Table, Knit Base	
1 Laminate top	1305
Total:	\$1305

STGTD Cesto Coffee Table, Fabric Base	
1 Laminate top	1305
2 Base fabric Gr.5	242
Total:	\$1547

COM/COL material requirement

Yardage is based on a non-patterned fabric. Additional yardage may be required for pattern repeats and the matching required. Leather yield may be affected by the quality of the COL. However, variance in the size of the hides will not affect the yield.

SINGLE UPHOLSTERY		COM [yards]	COL [sq. ft.]
Rectangular Table	Base	3	54
Side Table	Base	1 1/2	27
Coffee Table	Base	2	36

seam positions

Cesto seating with knit bases have two seams which are positioned on two sides from center of base to center of upper frame. Fabric bases have four seams which are positioned from the four corners.

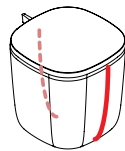

Knit Base

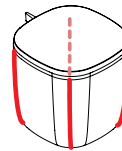

Fabric Base

STGTA cesto side table, knit base

Product Options

Surface Finish	Edge Trim Style	Knit Mesh Base Finish
Studio Foundation Laminate	8/G Flat Edge	K413 Eggshell K419 Goldenrod
Studio Veneer		K414 Stone K420 Sunset
Solid Surface		K415 Khaki K421 Cardinal
		K416 Silver K422 Magenta
		K417 Taupe K423 Cobalt
		K418 Graphite

Note Natural Leather handle included.

Price



Studio Foundation Laminate	Studio Veneer	Solid Surface
1016	1305	1332

STGTB cesto side table, fabric base

Product Options

Surface Finish	Edge Trim Style	Knit Mesh Base Finish
Studio Foundation Laminate	8/G Flat Edge	Base Upholstery Finish
Studio Veneer		Fabric
Solid Surface		Leather

Note Natural Leather handle included.

Price



Studio Foundation Laminate	Studio Veneer	Solid Surface												
1068	1357	1384												
COM	COL	Gr.1	Gr.2	Gr.3	Gr.4	Gr.5	Gr.6	Gr.7	Gr.8	Gr.9	Gr.10	Gr.11		
0	116	70	101	128	159	182	201	220	244	267	290	317		
Gr.12	Gr.13	Gr.14	Gr.15	Gr.16	Gr.17	Gr.18	Gr.19	Gr.20	Leather			LD		
348	386	426	464	502	542	580	618	658	LB	LC	LD			
									534	742	812			

STGTC cesto coffee table, knit base

Product Options

Style	Surface Finish	Edge Trim Style	Knit Mesh Base Finish
C Caster	Studio Foundation Laminate	8/G Flat Edge	K413 Eggshell
N No Caster	Studio Veneer		K414 Stone
	Solid Surface		K415 Khaki
			K416 Silver
			K417 Taupe
			K418 Graphite
			K419 Goldenrod
			K420 Sunset
			K421 Cardinal
			K422 Magenta
			K423 Cobalt

Note Natural Leather handle included.

Price



	Studio Foundation Laminate	Studio Veneer	Solid Surface
C Caster	1305	1882	1907
N No Caster	1305	1882	1907

STGTD cesto coffee table, fabric base

Product Options

Style	Surface Finish	Edge Trim Style	Base Upholstery Finish
C Caster	Studio Foundation Laminate	8/G Flat Edge	Fabric
N No Caster	Studio Veneer		Leather
	Solid Surface		

Note Natural Leather handle included.

Price



	Studio Foundation Laminate	Studio Veneer	Solid Surface										
C Caster	1357	1934	1959										
N No Caster	1357	1934	1959										
	COM	COL	Gr.1	Gr.2	Gr.3	Gr.4	Gr.5	Gr.6	Gr.7	Gr.8	Gr.9	Gr.10	Gr.11
C Caster	0	116	93	135	171	211	242	268	293	325	356	386	422
N No Caster	0	116	93	135	171	211	242	268	293	325	356	386	422
	Gr.12	Gr.13	Gr.14	Gr.15	Gr.16	Gr.17	Gr.18	Gr.19	Gr.20	Leather			
C Caster	464	515	567	618	670	722	774	825	877	LB	LC	LD	
N No Caster	464	515	567	618	670	722	774	825	877	673	951	1044	

STGTE cesto rectangular coffee table, knit base

Product Options

Style	Surface Finish	Edge Trim Style	Knit Mesh Base Finish
C Caster	Studio Foundation Laminate	8/G Flat Edge	K413 Eggshell
N No Caster	Studio Veneer		K414 Stone
	Solid Surface		K415 Khaki
			K416 Silver
			K417 Taupe
			K418 Graphite
			K419 Goldenrod
			K420 Sunset
			K421 Cardinal
			K422 Magenta
			K423 Cobalt

Price

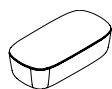

	Studio Foundation Laminate	Studio Veneer	Solid Surface
C Caster	1907	2485	3009
N No Caster	1907	2485	3009

STGTF cesto rectangular coffee table, fabric base

Product Options

Style	Surface Finish	Edge Trim Style	Base Upholstery Finish
C Caster	Studio Foundation Laminate	8/G Flat Edge	Fabric
N No Caster	Studio Veneer		Leather
	Solid Surface		

Note Natural Leather handle included.

Price

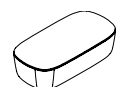

	Studio Foundation Laminate	Studio Veneer	Solid Surface										
C Caster	1959	2537	3061										
N No Caster	1959	2537	3061										
	COM	COL	Gr.1	Gr.2	Gr.3	Gr.4	Gr.5	Gr.6	Gr.7	Gr.8	Gr.9	Gr.10	Gr.11
C Caster	0	116	139	201	255	317	363	403	441	487	534	580	635
N No Caster	0	116	139	201	255	317	363	403	441	487	534	580	635
	Gr.12	Gr.13	Gr.14	Gr.15	Gr.16	Gr.17	Gr.18	Gr.19	Gr.20	Leather			
C Caster	696	774	850	928	1006	1082	1160	1238	1314	LB	LC	LD	
N No Caster	696	774	850	928	1006	1082	1160	1238	1314	951	1369	1508	

artifort compass

features

Offered through a partnership with Artifort in Schijndel, The Netherlands, Artifort Compass tables are simple, elegant wooden companions that enhance seating spaces and adapt naturally to flexible lifestyles. Designed by Mike & Maaïke, Artifort Compass' semi-circular surface is welcoming from many angles, allowing individuals to position and reposition to suit your needs quickly.

Artifort Compass perfectly harmonizes with Studio TK's chairs, lounges, sectionals, and sofas. Its low-profile base slips conveniently under your sofa or chair while its cantilevered design brings the surface comfortably close. Artifort Compass can be rotated to one side, positioned in front, or hovered over your lap, providing the perfect surface for a drink or the ideal position for your laptop.

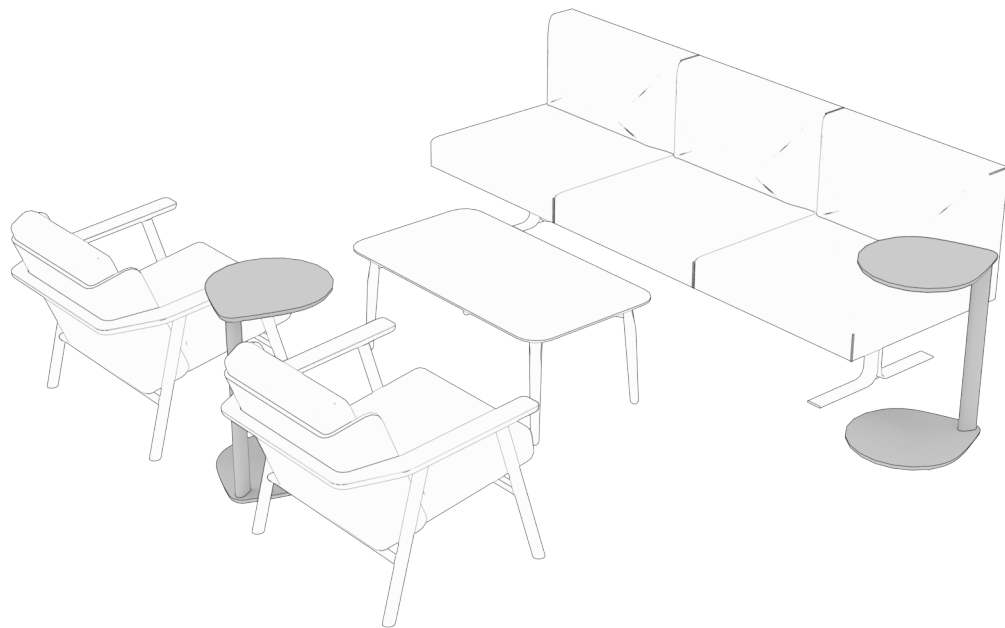

dimensions

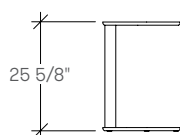
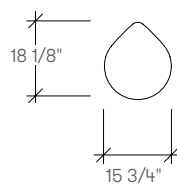

Artifort Compass
Task Table
(ARCT)

artifort compass

planning

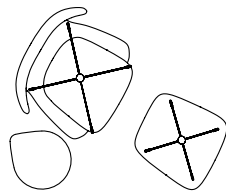
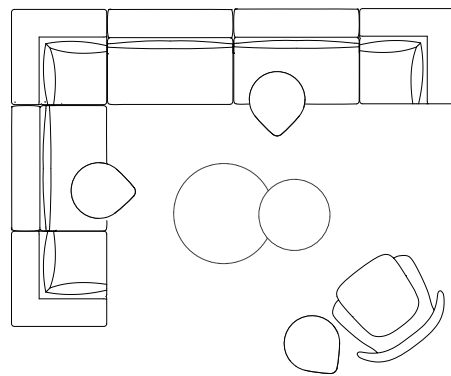
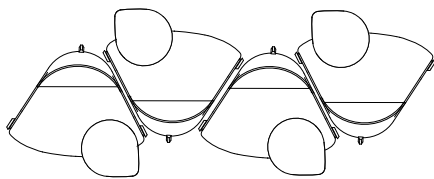
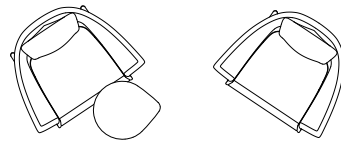
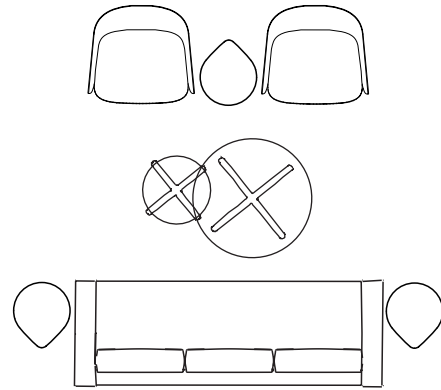
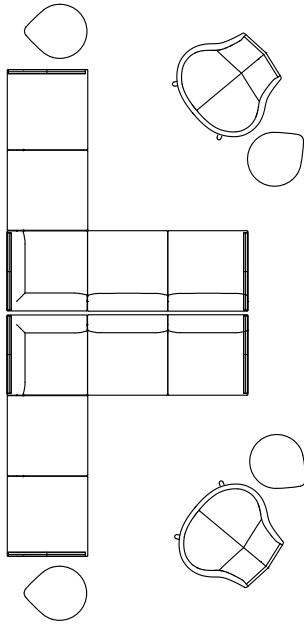

ARCT artifort compass task table

Product Options

Height 25 25" / 63cm	Wood Base Finish BU Compass Basque White Oak DZ Compass Truffle
--------------------------------	--

Note Artifort Compass has an oil finish and is open pore. The finishes are coordinates to Studio TK wood finishes.

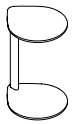

25 25" / 63cm

Price

1050

fractals nook

features

Fractals Nook, an extension of the Fractals Seating product, uses an organic high shell with an added worksurface to create an intimate desk carrel for heads down work. Fractals Nook allows for users to create a distraction free zone for work. The natural curves of Fractals create unique space planning capabilities for social spaces that require the need for privacy. The addition of the Fractals Nook now allows for new planning scenarios for the complete Fractals line. It offers the ability to intertwine high back lounge pieces with high desk nooks.

Fractals Nook allows the same broad canvas of the lounge series for the selection of multiple fabrics and finishes to create your own distinctive look. Powdercoat finishes on both the legs and the inner frame are chosen individually as well as inner and outer fabric selection for those environments that encourage space division emphasized by finish.

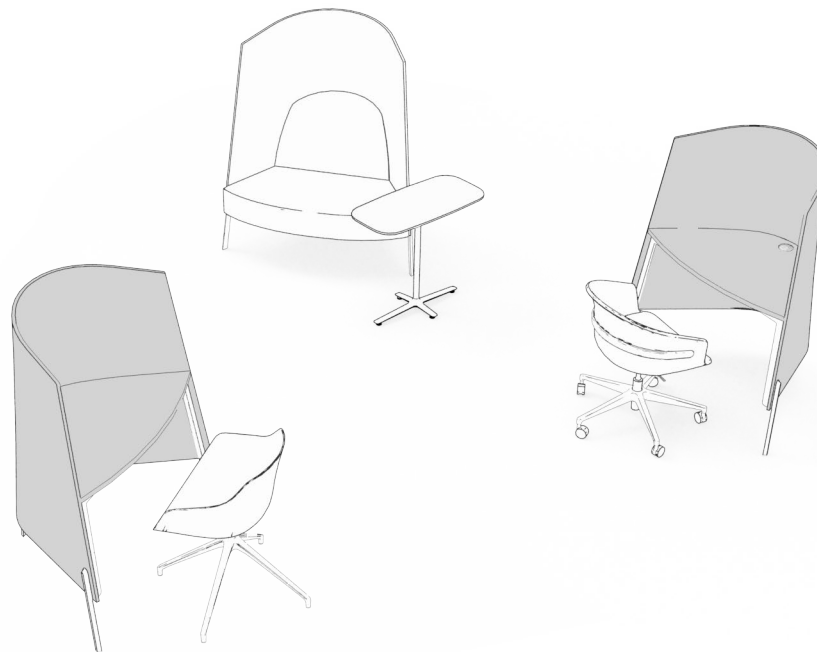

dimensions

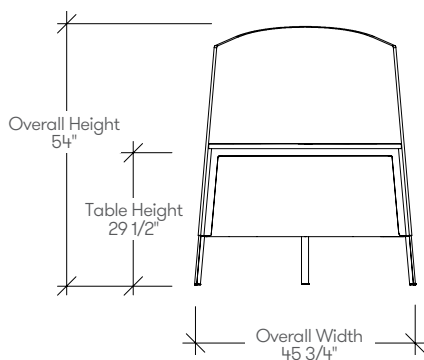

Fractals Nook
(STFNN)
 side view

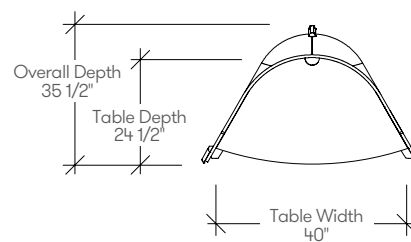

Fractals Nook
(STFNN)
 front view

fractals nook

planning

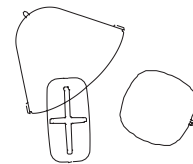
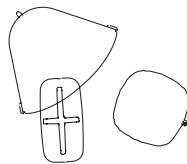
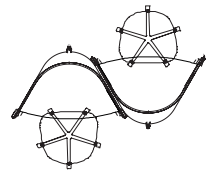
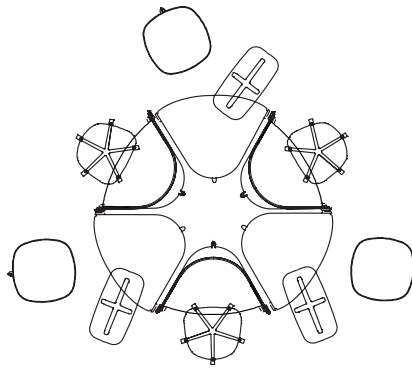
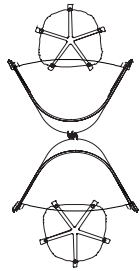
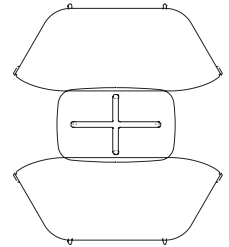
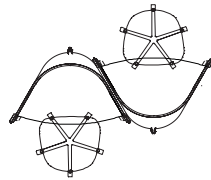
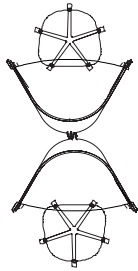
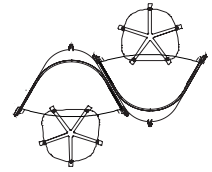
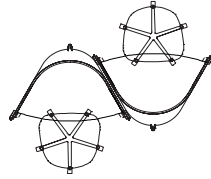
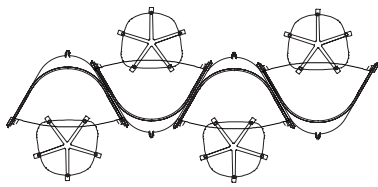

specifying fractals nook finishes

Fractals Nook permits a wide range of combinations that vary dependent of the configuration specified. The following demonstrates the order that must be selected.

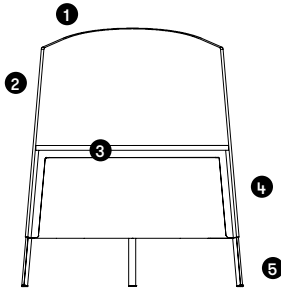

- 1 **Inner Back Upholstery**
Select inner back upholstery
- 2 **Outer Back Upholstery**
Select outer back upholstery
- 3 **Surface Finish**
Select surface finish

- 4 **Inner Frame Finish**
Select inner frame finish
- 5 **Leg Finish**
Select leg finish

specification example

STFND Fractals Nook, Power Cut Out for Single Round Bump	
1 Inner Back Gr. 5	2915
2 Outer Back Gr. 3	115
3 Surface Finish Foundation Laminate	0
Total:	\$3030

STFND Fractals Nook, Power Cut Out for Single Round Bump	
1 Inner Back Gr. 9	3086
2 Outer Back Gr. 3	115
3 Surface Finish Veneer	232
Total:	\$3432

STFNN Fractals Nook, No Cut Out	
1 Inner Back Gr. 5	2938
2 Outer Back Gr. 3	115
3 Surface Finish Foundation Laminate	0
Total:	\$3053

STFNN Fractals Nook, No Cut Out	
1 Inner Back Gr. 9	3109
2 Outer Back Gr. 3	115
3 Surface Finish Veneer	232
Total:	\$3456

COM/COL material requirement

Yardage is based on a non-patterned fabric. Additional yardage may be required for pattern repeats and the matching required. Leather yield may be affected by the quality of the COL. However, variance in the size of the hides will not affect the yield.

SINGLE UPHOLSTERY

	COM [yards]	COL [sq. ft.]
Inner Back	3	54
Outer Back	3	54

STFN fractals nook

Product Options

Power Cut Out	Inner Back Upholstery	Outer Back Upholstery	Surface Finish	Inner Frame Finish	Leg Finish	
N No Cut Out	Fabric	Fabric	Studio Foundation Laminate	Fundamental Paint	C6 Chrome	
D Power Cut Out for Single Round Power Bump					Leather	Leather

Note For Laminate Surface, add \$0
 For Studio Veneer Surface, add \$232
 For Inner Frame Fundamental and Fashion Paint, add \$0
 For Chrome Leg, add \$0
 For Fundamental Leg Finish, add \$64
 For Fashion Leg Finish, add \$87
 POWER UNIT SOLD SEPARATELY



Inner Back

	COM	COL	Gr.1	Gr.2	Gr.3	Gr.4	Gr.5	Gr.6	Gr.7	Gr.8	Gr.9	Gr.10	Gr.11
N No Cut Out	2575	2729	2714	2776	2830	2892	2938	2978	3016	3062	3109	3155	3210
D Power Cut Out	2552	2705	2691	2753	2807	2869	2915	2955	2993	3039	3086	3132	3187
											Leather		
											LB	LC	LD
N No Cut Out	3271	3349	3425	3503	3581	3657	3735	3813	3889		3565	3982	4121
D Power Cut Out	3248	3326	3402	3480	3558	3634	3712	3790	3866		3540	3958	4097

Outer Back

	COM	COL	Gr.1	Gr.2	Gr.3	Gr.4	Gr.5	Gr.6	Gr.7	Gr.8	Gr.9	Gr.10	Gr.11
N No Cut Out	116	116	63	90	115	143	164	181	198	219	240	261	285
D Power Cut Out	116	116	63	90	115	143	164	181	198	219	240	261	285
											Leather		
											LB	LC	LD
N No Cut Out	313	348	383	418	452	487	522	557	592		376	564	626
D Power Cut Out	313	348	383	418	452	487	522	557	592		376	564	626

freehand

features

Freehand occasional tables were designed around the free-flowing pencil of an artist. The inspiration is the juxtaposition of a super mechanical process of extruding aluminum to these forms that are organic and imperfect, and flow from one piece to the next.

Though not perfectly symmetrical, table sides fit together to form a number of geometric shapes that can then be finished with tabletop surfaces. Sides are available in two shapes and three sizes. Freehand can be uniquely decorated in Studio TK's Fundamental and Fashion powdercoat finishes. Tabletops are available in leather, felt, linoleum and glass. The finishes narrative extends from a monochromatic look that's more hospitality-focused, to the felt and leather tops with a pop of color that tells more of a craft story. Freehand's breadth of options allows users and designers to customize to suit their project needs.

Designed by the London-based studio Pearson Lloyd.

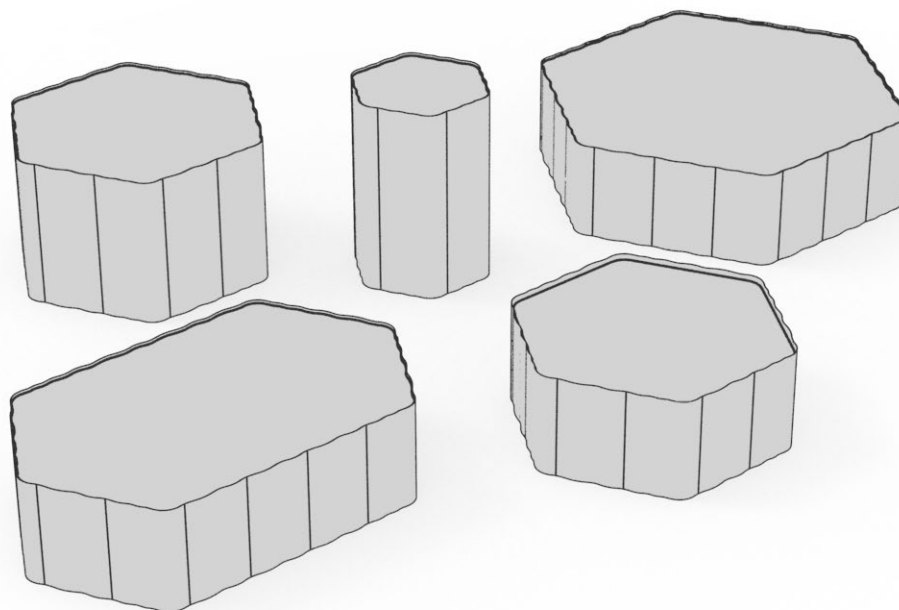

dimensions

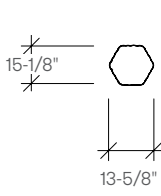

Freehand Side
Table
(STATA)

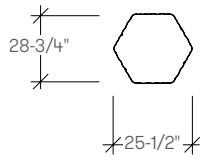

Freehand 29\"/>
Occasional Table
(STATB11)

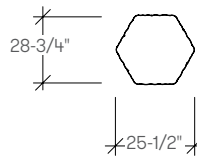

Freehand 29\"/>
Occasional Table
(STATB16)

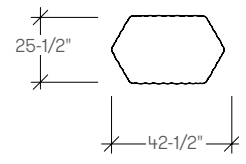

Freehand 26" x 43\"/>
Occasional Table
(STATC)

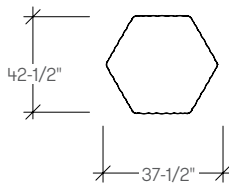
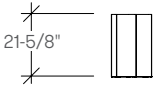

Freehand 43\"/>
Occasional Table
(STATD)

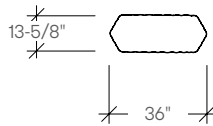
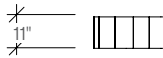

Freehand 14" x 36\"/>
Occasional Table
(STATE11)

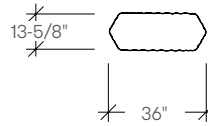
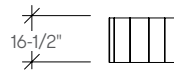

Freehand 14" x 36\"/>
Occasional Table
(STATE16)

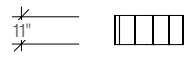

freehand tables

planning

With various top sizes, surface materials and base finishes, Freehand Tables offers true personalization of any scenario requiring tables.

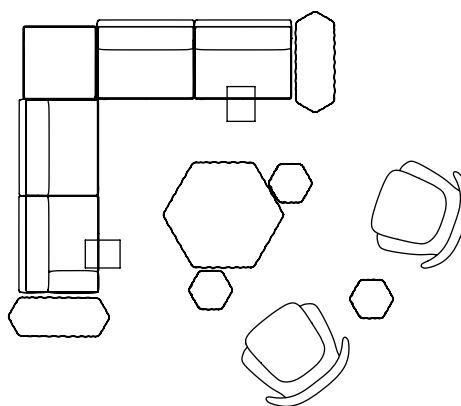
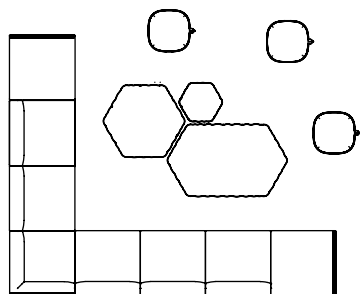
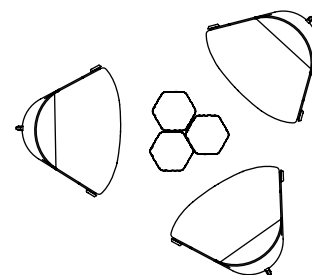
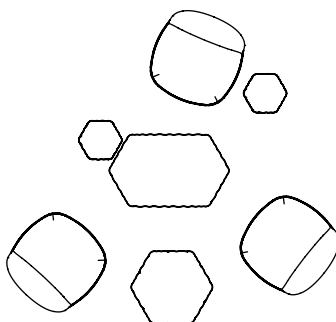
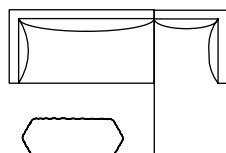
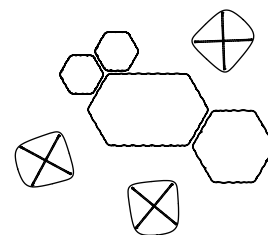
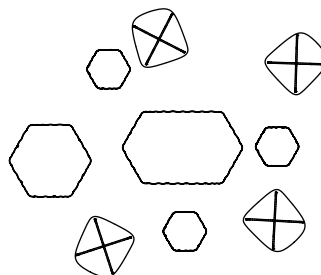
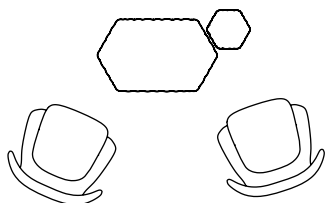
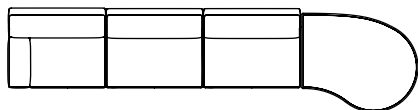

specifying freehand finishes

Freehand Tables permits a wide range of combinations that vary dependent of the configuration specified. The following demonstrates the order that must be selected.

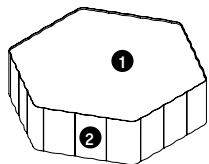

- 1 **Top Surface**
Select top surface finish
- 2 **Base Finish**
Select base upholstery

specification example

STATA Freehand Side Table	
1 Linoleum top	983
2 Fundamental base finish	0
Total:	\$983

STATA Freehand Side Table	
1 Laminate top	983
2 Fashion base finish	64
Total:	\$1046

STATA freehand side table

Product Options

Top Finish	Base Finish
Linoleum	Fundamental Paint
Felt	Fashion Paint
Saddle Leather	
Back-Painted Glass	

Note For Fashion Paint Finish, add \$64



Price

Linoleum	Felt	Saddle Leather	Back-Painted Glass
983	1007	1206	1231

STATB freehand 29" occasional table

Product Options

Height	Top Finish	Base Finish
11 11" / 28cm	Linoleum	Fundamental Paint
16 16-1/2" / 42cm	Felt	Fashion Paint
	Saddle Leather	
	Back-Painted Glass	

Note For Fashion Paint Finish, add \$116



Price

	Linoleum	Felt	Saddle Leather	Back-Painted Glass
11 11" / 28cm	1528	1576	1922	2195
16 16-1/2" / 42cm	1898	1948	2293	2565

STATC freehand 26" x 43" occasional table

Product Options

Top Finish	Base Finish
Linoleum	Fundamental Paint
Felt	Fashion Paint
Saddle Leather	
Back-Painted Glass	

Note For Fashion Paint Finish, add \$116

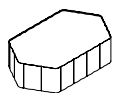

Price

Linoleum	Felt	Saddle Leather	Back-Painted Glass
2046	2095	2787	3036

STATD freehand 43" occasional table

Product Options

Top Finish	Base Finish
Linoleum	Fundamental Paint
Felt	Fashion Paint
Saddle Leather	
Back-Painted Glass	

Note For Fashion Paint Finish, add \$116



Price

Linoleum	Felt	Saddle Leather	Back-Painted Glass
2392	2466	3579	3703

STATE freehand 14" x 43" occasional table

Product Options

Height	Top Finish	Base Finish
11 11" / 28cm	Linoleum	Fundamental Paint
16 16-1/2" / 42cm	Felt Saddle Leather Back-Painted Glass	Fashion Paint

Note For Fashion Paint Finish, add \$116



	Price			
	Linoleum	Felt	Saddle Leather	Back-Painted Glass
11 11" / 28cm	1478	1528	1972	2022
16 16-1/2" / 42cm	1848	1898	2342	2392

havn tables

features

In coordination with the Havn lounge series, Busk+Hertzog set out to create a small yet versatile series of universal occasional tables that matched Havn seating's crafted architecture.

Havn tables complement Havn lounge seating both in design and functionality but, at the same time, work perfectly on their own or together with other lounge furniture, within or outside the Studio TK collection. Combining various heights, sizes, shapes, materials and colors, Havn configurations are as endless as the ways they can be applied.

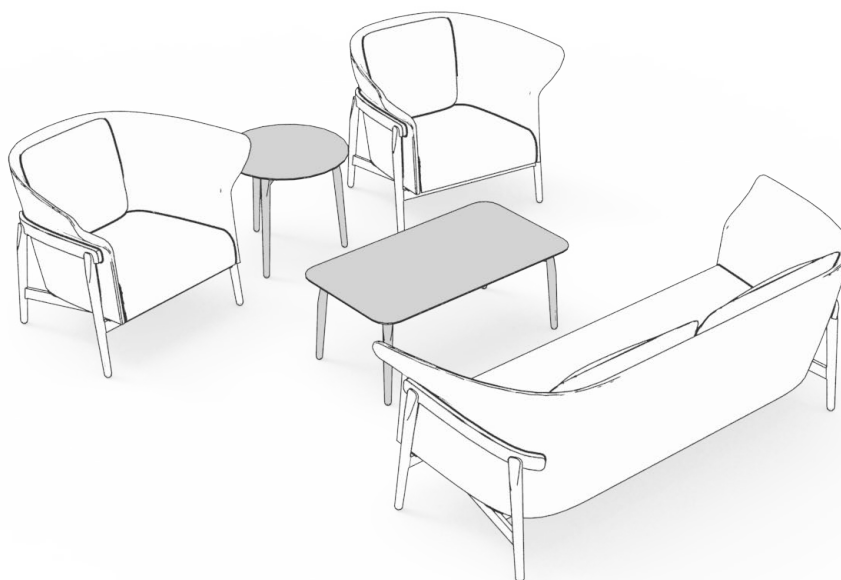

havn dimensions

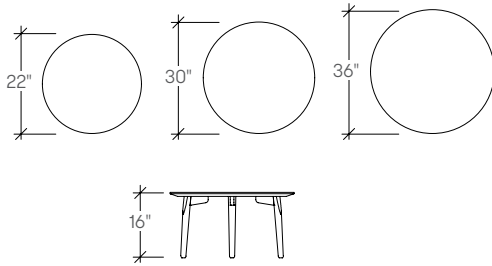

Havn Round Occasional Table
(STNJ)

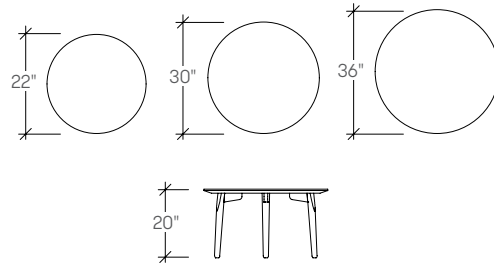

Havn Round Occasional Table
(STNJ)

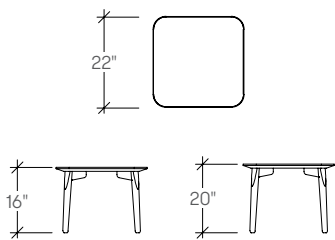

Havn Square Occasional Table
(STNK)

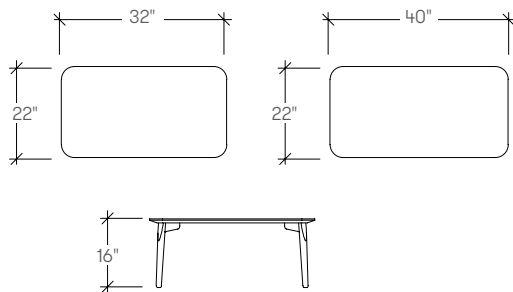

Havn Rectangular Occasional Table
(STNL)

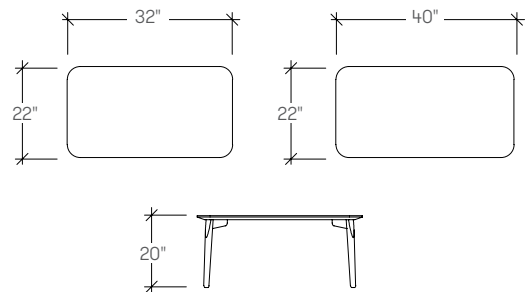

Havn Rectangular Occasional Table
(STNL)

havn tables

planning

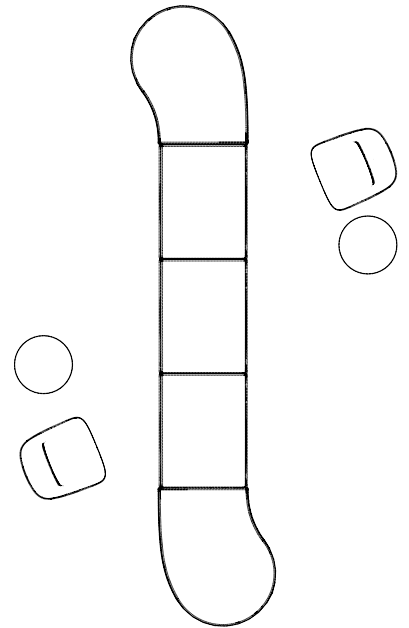
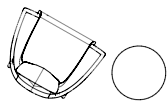
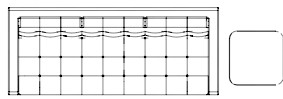
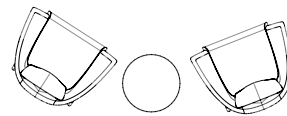
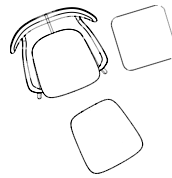
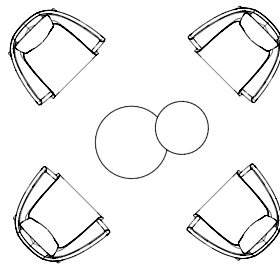
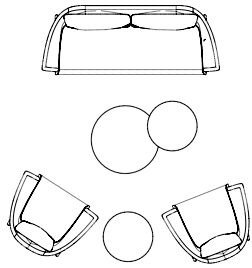

STNJ havn round occasional table

Product Options

Top Size	Height	Surface Finish	Leg Finish
22 22" Dia / 56cm	16 16" / 41cm	Studio Foundation Laminate	BU Basque White Oak
30 30" Dia / 76cm	20 20" / 51cm	Studio Veneer	DY Cocoa Brown
36 36" Dia / 91cm			DV Sierra
			DZ Truffle
			NK Natural Oak

Note Havn tables always feature a Knife Edge detail

Price



	Studio Foundation Laminate	Studio Veneer
22 22" Dia x 16" High / 56cm x 41cm	1158	1248
22 22" Dia x 20" High / 61cm x 51cm	1188	1279
30 30" Dia x 16" High / 76cm x 41cm	1334	1394
30 30" Dia x 20" High / 76cm x 51cm	1364	1426
36 36" Dia x 16" High / 76cm x 41cm	1505	1565
36 36" Dia x 20" High / 76cm x 51cm	1535	1596

STNK havn square occasional table

Product Options

Top Size	Height	Surface Finish	Leg Finish
22 22" Dia / 56cm	16 16" / 41cm	Studio Foundation Laminate	BU Basque White Oak
	20 20" / 51cm	Studio Veneer	DY Cocoa Brown
			DV Sierra
			DZ Truffle
			NK Natural Oak

Note Havn tables always feature a Knife Edge detail

Price



	Studio Foundation Laminate	Studio Veneer
22 22" Dia x 16" High / 56cm x 41cm	1334	1456
22 22" Dia x 20" High / 61cm x 51cm	1364	1486

STNL havn rectangular occasional table

Product Options

Top Size	Height	Surface Finish	Leg Finish
32 22" Wide x 32" Deep / 56cm x 81cm	16 16" / 41cm	Studio Foundation Laminate	BU Basque White Oak
40 22" Wide x 40" Deep / 56cm x 102cm	20 20" / 51cm	Studio Veneer	DY Cocoa Brown
			DV Sierra
			DZ Truffle
			NK Natural Oak

Note Havn tables always feature a Knife Edge detail



32 22" w x 32" d x 16" High / 56cm x 81cm x 41cm
32 22" w x 32" d x 20" High / 56cm x 102cm x 51cm
40 22" w x 40" d x 16" High / 56cm x 81cm x 41cm
40 22" w x 40" d x 20" High / 56cm x 102cm x 51cm

Price

Studio Foundation Laminate	Studio Veneer
1456	1578
1486	1608
1578	1699
1608	1730

mari-sol

Studio TK is offering Mari-Sol Café, Occasional and Work tables in North America in partnership with Vondom – a leading Spanish provider of furniture for modern indoor and outdoor commercial spaces. Mari-Sol is a table collection designed by Eugeni Quitllet that combines technology in its function with sensuality in its shape. Different dimensions allow the tables to adapt to any environment.

Café Tables, Occasional Tables and Work Tables are offered in different combinations of base styles, and various sizes of Round and Square Tops.



mari-sol dimensions

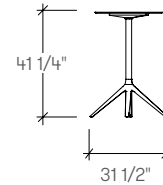
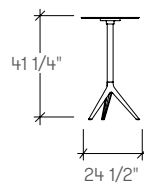
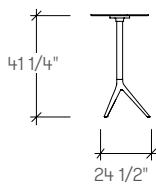
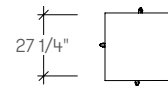
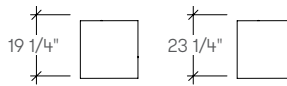
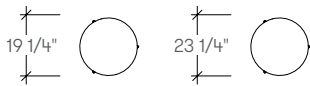

Mari-Sol Cafe Table,
3-Star Base, Round Top
(VMMCT3R)

Mari-Sol Cafe Table,
3-Star Base, Square Top
(VMMCT3S)

Mari-Sol Cafe Table,
4-Star Base, Square Top
(VMMCT4S)

mari-sol dimensions

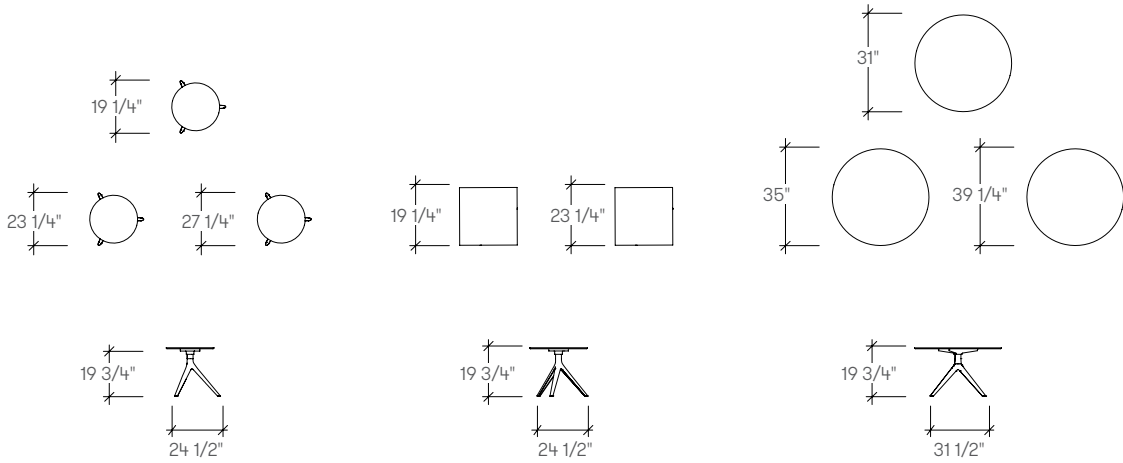

Mari-Sol Occasional Table,
3-Star Base, Round Top
(VMMOT3R)

Mari-Sol Occasional Table,
3-Star Base, Square Top
(VMMOT3S)

Mari-Sol Occasional Table,
4-Star Base, Round Top
(VMMOT4R)

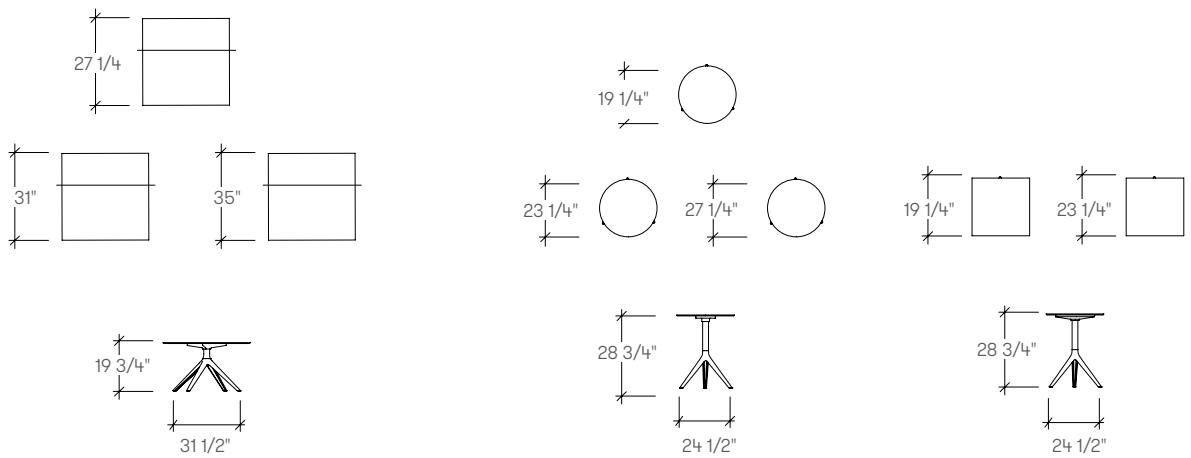

Mari-Sol Occasional Table,
4-Star Base, Square Top
(VMMOT4S)

Mari-Sol Work Table,
3-Star Base, Round Top
(VMMWT)

Mari-Sol Work Table,
3-Star Base, Square Top
(VMMWT)

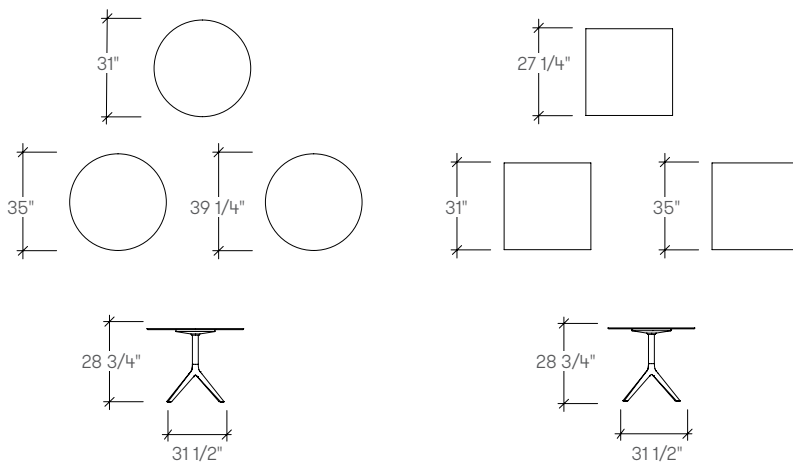

Mari-Sol Work Table,
4-Star Base, Round Top
(VMMWT)

Mari-Sol Work Table,
4-Star Base, Square Top
(VMMWT)

mari-sol

planning

A variety of configurations can be achieved with Mari-sol, allowing for various configurations. The following typical demonstrate the versatility that can be achieved.

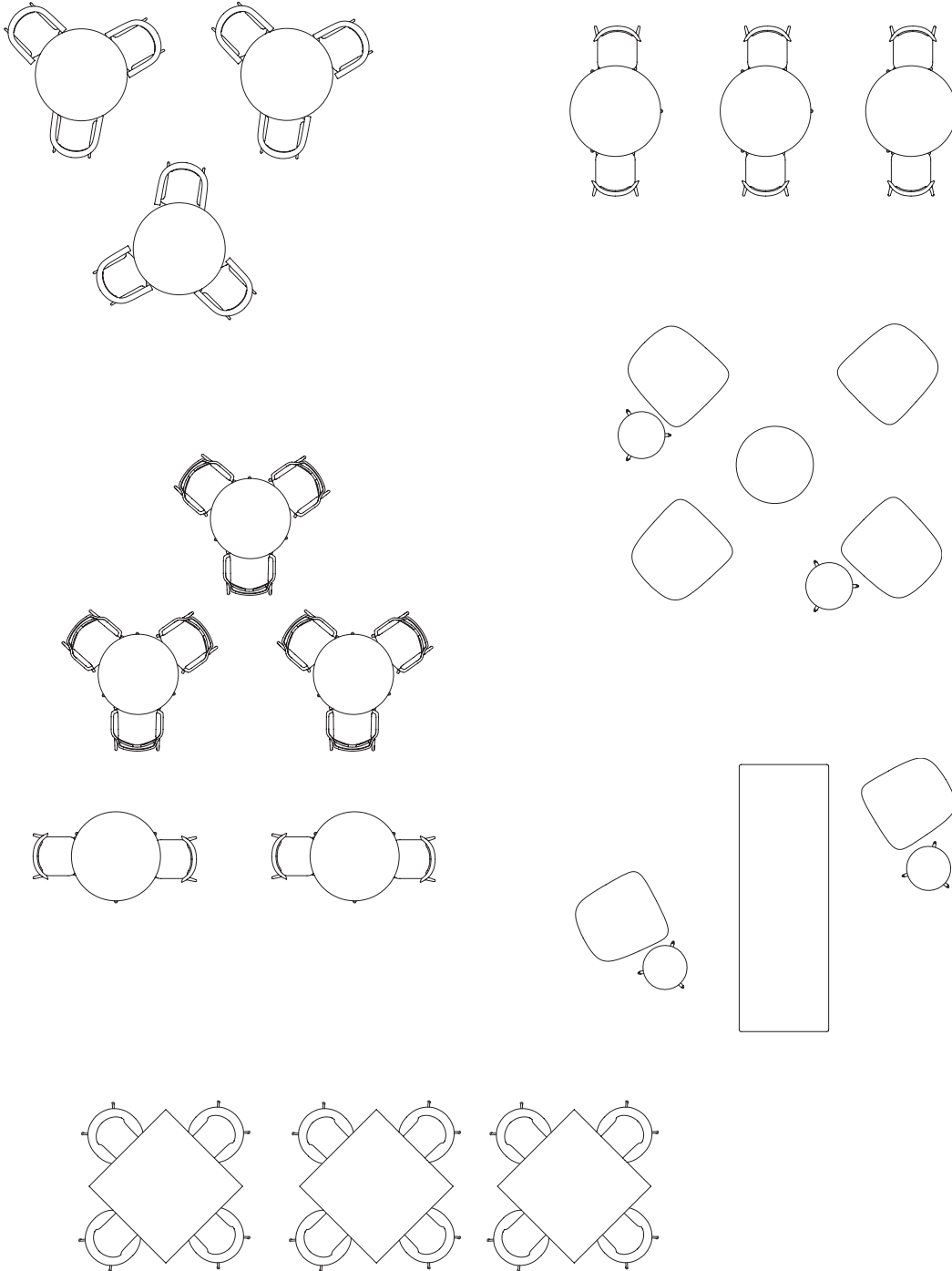



VMMCT mari-sol cafe table, 3-star base

Product Options

Style	Top Size	Vondom Surface Finish	Base Finish
3R 3-star base, round top	19 19 1/4" / 49cm	RX Ebony Solid Core	52 Ebony
3S 3-star base, square top	23 23 1/4" / 59cm	RY White Solid Core	83 Very White

Note Tables ship unassembled and will require assembly in the field.

	Price
 3R 3-star base, round top, 19 1/4" / 49cm	806
3R 3-star base, round top, 23 1/4" / 59cm	847
 3S 3-star base, square top, 19 1/4" / 49cm	806
3S 3-star base, square top, 23 1/4" / 59cm	847

VMMCT mari-sol cafe table, 4-star base

Product Options

Style	Top Size	Vondom Surface Finish	Base Finish
4S 4-star base, square top	27 27 1/4" / 69cm	RX Ebony Solid Core RY White Solid Core	52 Ebony 83 Very White

Note Tables ship unassembled and will require assembly in the field.

	Price
 4S 4-star base, square top, 27 1/4" / 69cm	1096

VMMOT mari-sol occasional table, 3-star base

Product Options

Style	Top Size	Vondom Surface Finish	Base Finish
3R 3-star base, round top	19 19 1/4" / 49cm	RX Ebony Solid Core	52 Ebony
3S 3-star base, square top	23 23 1/4" / 59cm	RY White Solid Core	83 Very White
	27 27 1/4" / 69cm		

Note Tables ship unassembled and will require assembly in the field.



	Price
3R 3-star base, round top, 19 1/4" / 49cm	737
3R 3-star base, round top, 23 1/4" / 59cm	777
3R 3-star base, round top, 27 1/4" / 69cm	864



3S 3-star base, square top, 19 1/4" / 49cm	737
3S 3-star base, square top, 23 1/4" / 59cm	777

VMMOT mari-sol occasional table, 4-star base

Product Options

Style	Top Size	Vondom Surface Finish	Base Finish
4R 4-star base, round top	27 27 1/4" / 69cm	RX Ebony Solid Core	52 Ebony
4S 4-star base, square top	31 31" / 79cm	RY White Solid Core	83 Very White
	35 35" / 89cm		
	39 39 1/4" / 99cm		

Note Tables ship unassembled and will require assembly in the field.



	Price
4R 4-star base, round top, 31" / 79cm	1131
4R 4-star base, round top, 35" / 89cm	1201
4R 4-star base, round top, 39 1/4" / 99cm	1485

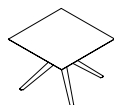



4S 4-star base, square top, 27 1/4" / 69cm	1027
4S 4-star base, square top, 31" / 79cm	1131
4S 4-star base, square top, 35" / 89cm	1201

VMMWT mari-sol work table, 3-star base

Product Options

Style	Top Size	Vondom Surface Finish	Base Finish
3R 3-star base, round top	19 19 1/4" / 49cm	RX Ebony Solid Core	52 Ebony
3S 3-star base, square top	23 23 1/4" / 59cm	RY White Solid Core	83 Very White
	27 27 1/4" / 69cm		

Note Tables ship unassembled and will require assembly in the field.



	Price
 3R 3-star base, round top, 19 1/4" / 49cm	766
3R 3-star base, round top, 23 1/4" / 59cm	806
3R 3-star base, round top, 27 1/4" / 69cm	899
 3S 3-star base, square top, 19 1/4" / 49cm	766
3S 3-star base, square top, 23 1/4" / 59cm	806

VMMWT mari-sol work table, 4-star base

Product Options

Style	Top Size	Vondom Surface Finish	Base Finish
4R 4-star base, round top	27 27 1/4" / 69cm	RX Ebony Solid Core	52 Ebony
4S 4-star base, square top	31 31" / 79cm	RY White Solid Core	83 Very White
	35 35" / 89cm		
	39 39 1/4" / 99cm		

Note Tables ship unassembled and will require assembly in the field.

	Price
 4R 4-star base, round top, 31" / 79cm	1172
4R 4-star base, round top, 35" / 89cm	1247
4R 4-star base, round top, 39 1/4" / 99cm	1525
 4S 4-star base, square top, 27 1/4" / 69cm	1067
4S 4-star base, square top, 31" / 79cm	1172
4S 4-star base, square top, 35" / 89cm	1247

rec

features

Designed by Christophe Pillet, Rec worktables are inspired by the raw, rectangular worktable from the industrial age. Rec creates high work postures ideal for today's social spaces. Rec worktables provide compelling high work settings for the more active worker and creative types – those who need to sit or stand and accomplish solo, heads-down work. Rec supports applications that serve both perimeter and open space planning, for personal touchdown, quick gatherings and longer-term collaborative work scenarios.

Rec worktables are offered in three popular heights. Two top styles in multiple sizes are available in linoleum, laminate and veneer. Three base styles are offered in a wide variety of powder coat colors.

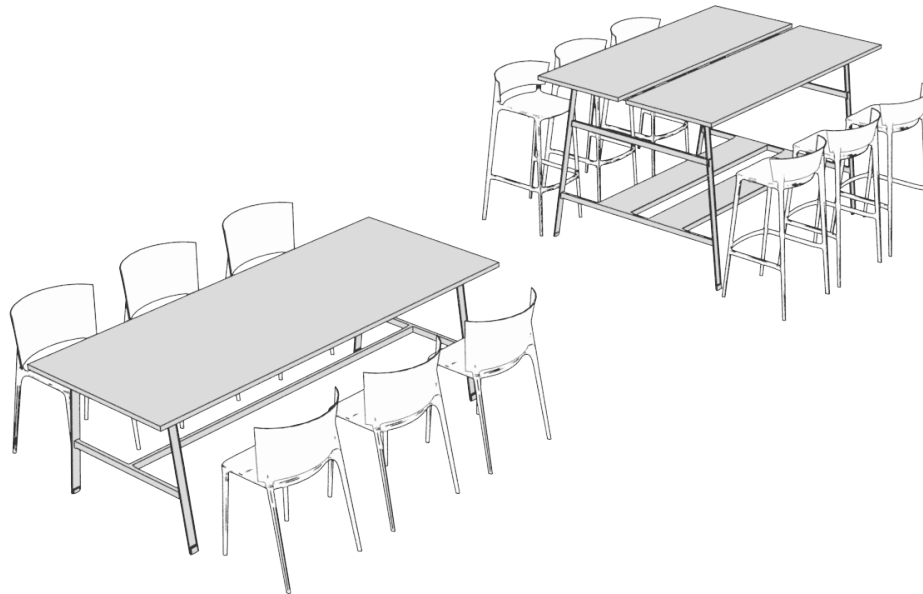

rec

rec dimensions

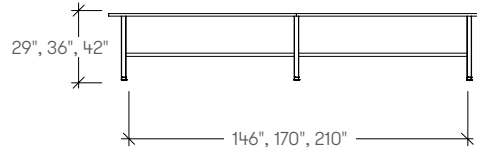
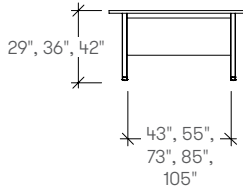
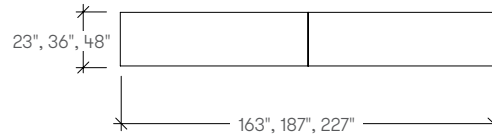
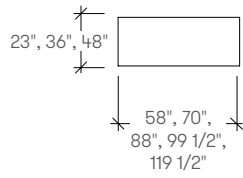

Rec Single Top
Workshop Table
(STMA)

Rec Ganged Single
Top Workshop Tables
(STMB)

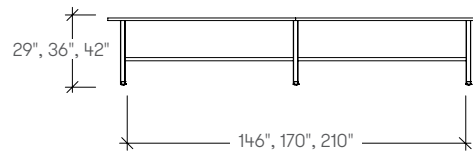
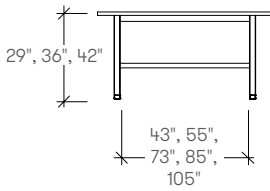
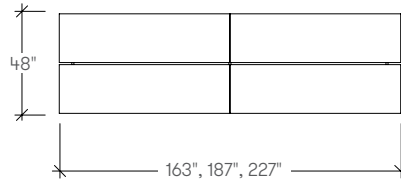
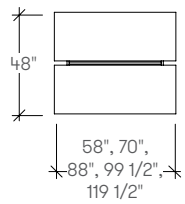

Rec Split Top
Workshop Table
(STMD)

Rec Ganged Split Top
Workshop Table
(STMC)

rec

rec details



Thin cross rail on the 29" x 29" high or 36" high models of all rec tables

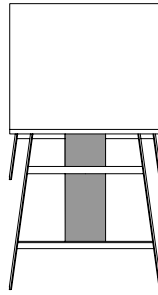

Single footrest on the 42" high x 23" deep or 36" deep tables

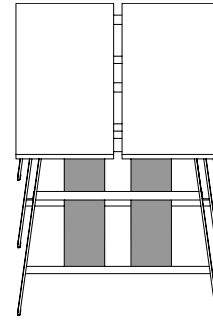

Double footrest on the 42" high x 48" deep tables

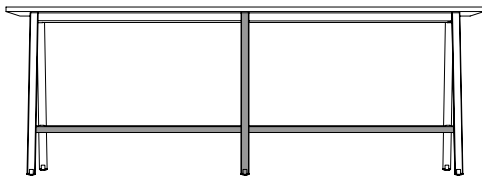

The 119" wide tables at 36" and 42" high will now have a third (middle) leg.

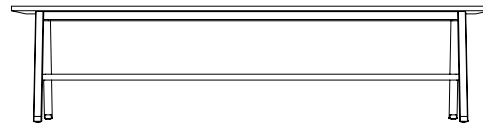

The 29" high will remain with 2 legs.

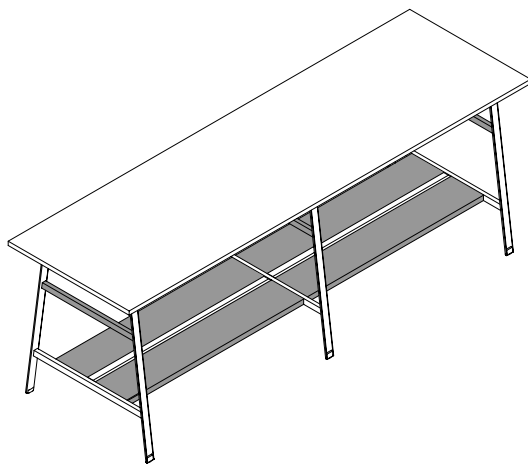

The 36" deep and 48" deep tables at 42" high have a crossbar in the leg for all widths.

rec

planning

A variety of configurations can be achieved with Rec Tables, allowing for various configurations. The following typicals demonstrate the versatility that can be achieved.

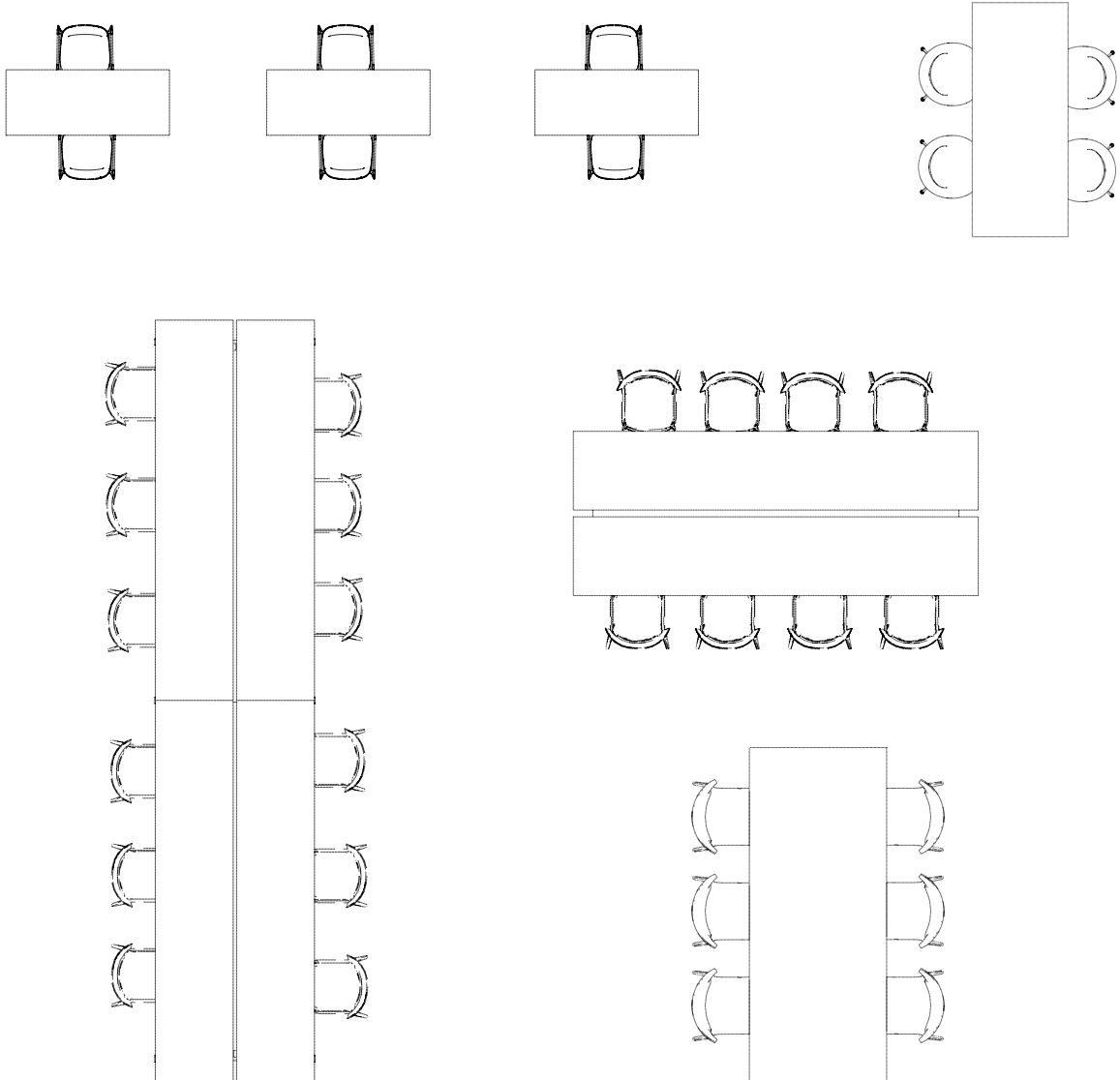

rec

recommended occupancy

The following demonstrates the recommended table occupancy to allow for adequate personal and working space and proper alignments with the Rec table.

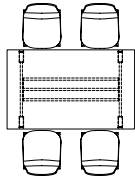

58" wide Rec Single Top
Workshop Table with Chairs
4 people maximum

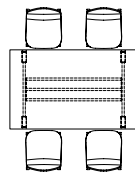

58" wide Rec Single Top
Workshop Table with Stools
4 people maximum

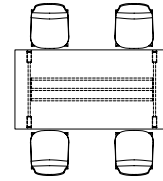

70" wide Rec Single Top
Workshop Table with Chairs
4 people maximum

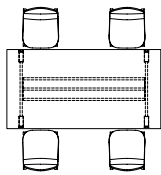

70" wide Rec Single Top
Workshop Table with Stools
4 people maximum

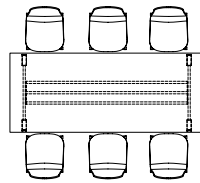

88" wide Rec Single Top
Workshop Table with Chairs
6 people maximum

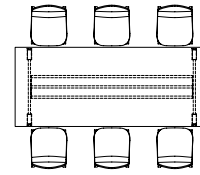

88" wide Rec Single Top
Workshop Table with Stools
6 people maximum

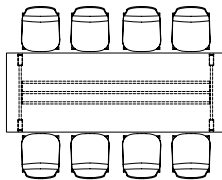

99 1/2" wide Rec Single Top
Workshop Table with Chairs
8 people maximum

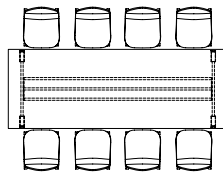

99 1/2" wide Rec Single Top
Workshop Table with Stools
8 people maximum

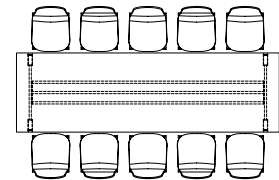

119 1/2" wide Rec Single Top
Workshop Table with Chairs
10 people maximum

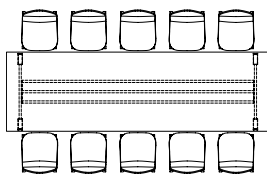

119 1/2" wide Rec Single Top
Workshop Table with Stools
10 people maximum

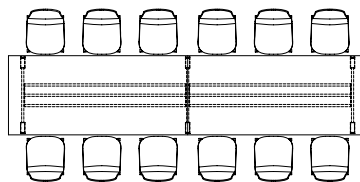

163" wide Rec Ganged Single Top
Workshop Table with Chairs
12 people maximum

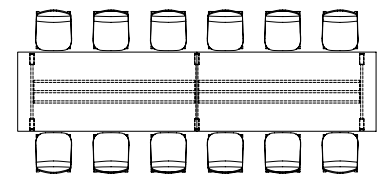

163" wide Rec Ganged Single Top
Workshop Table with Stools
12 people maximum

rec

recommended occupancy

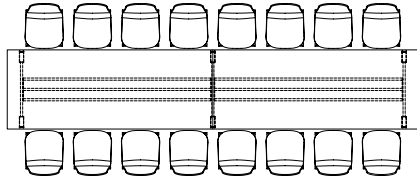

187" wide Rec Ganged Single Top
Workshop Table with Chairs
16 people maximum

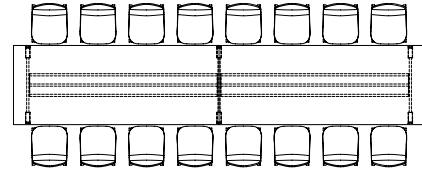

187" wide Rec Ganged Single Top
Workshop Table with Stools
16 people maximum

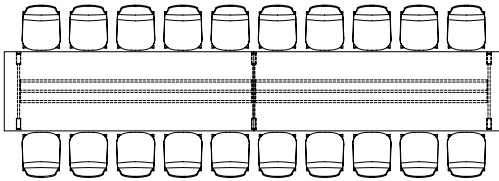

227" wide Rec Ganged Single Top
Workshop Table with Chairs
20 people maximum

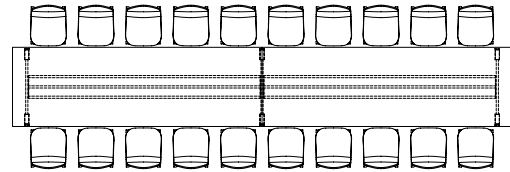

227" wide Rec Ganged Single Top
Workshop Table with Stools
20 people maximum

STMA rec single top workshop table

Product Options

Depth	Width	Height	Power	Surface Finish	Base Finish
A 23" / 58cm	A 58" / 147cm	29 29" / 74cm	N No Power	Studio Foundation Laminate	Fundamental Paint
B 36" / 91cm	B 70" / 178cm	36 36" / 91cm	P Power Cut Out	Linoleum	Fashion Paint
C 48" / 122cm	C 88" / 224cm	42 42" / 107cm		Studio Veneer	
	D 99 1/2" / 253cm				
	E 119 1/2" / 304cm				

Note For Fashion Paint Finish, add \$58
 For power-cut out of 58", 70", 88" width use Single Round Power Bump (STYD), add \$46
 For power-cut out of 99.5", 119.5" width use Dual Round Power Bump (STYE), add \$46
 POWER UNIT SOLD SEPARATELY



	Price		
	Studio Foundation Laminate	Linoleum	Studio Veneer
A 23" d x 58" w x 29" h / 58cm x 147cm x 29cm, No Power	2252	3004	3131
A 23" d x 58" w x 36" h / 58cm x 147cm x 91cm, No Power	2314	3067	3192
A 23" d x 58" w x 42" h / 58cm x 147cm x 107cm, No Power	2690	3443	3569
A 23" d x 70" w x 29" h / 58cm x 178cm x 29cm, No Power	2378	3131	3256
A 23" d x 70" w x 36" h / 58cm x 178cm x 91cm, No Power	2439	3192	3318
A 23" d x 70" w x 42" h / 58cm x 178cm x 107cm, No Power	2816	3569	3695
A 23" d x 88" w x 29" h / 58cm x 224cm x 29cm, No Power	2629	3381	3507
A 23" d x 88" w x 36" h / 58cm x 224cm x 91cm, No Power	2690	3443	3569
A 23" d x 88" w x 42" h / 58cm x 224cm x 107cm, No Power	3256	4009	4134
A 23" d x 99 1/2" w x 29" h / 58cm x 253cm x 29cm, No Power	2754	3507	3632
A 23" d x 99 1/2" w x 36" h / 58cm x 253cm x 91cm, No Power	2816	3569	3695
A 23" d x 99 1/2" w x 42" h / 58cm x 253cm x 107cm, No Power	3381	4134	4260
A 23" d x 119 1/2" w x 29" h / 58cm x 304cm x 29cm, No Power	3131	3757	3883
A 23" d x 119 1/2" w x 36" h / 58cm x 304cm x 91cm, No Power	3192	3820	3945
A 23" d x 119 1/2" w x 42" h / 58cm x 304cm x 107cm, No Power	3757	4385	4510
B 36" d x 58" w x 29" h / 91cm x 147cm x 29cm, No Power	2629	3507	3632
B 36" d x 58" w x 36" h / 91cm x 147cm x 91cm, No Power	2690	3569	3695
B 36" d x 58" w x 42" h / 91cm x 147cm x 107cm, No Power	3131	4009	4134
B 36" d x 70" w x 29" h / 91cm x 178cm x 29cm, No Power	3004	3883	4009
B 36" d x 70" w x 36" h / 91cm x 178cm x 91cm, No Power	3067	3945	4070
B 36" d x 70" w x 42" h / 91cm x 178cm x 107cm, No Power	3507	4385	4510
B 36" d x 88" w x 29" h / 91cm x 224cm x 29cm, No Power	3192	4070	4196
B 36" d x 88" w x 36" h / 91cm x 224cm x 91cm, No Power	3256	4134	4260
B 36" d x 88" w x 42" h / 91cm x 224cm x 107cm, No Power	3883	4761	4887
B 36" d x 99 1/2" w x 29" h / 91cm x 253cm x 29cm, No Power	3381	4260	4385
B 36" d x 99 1/2" w x 36" h / 91cm x 253cm x 91cm, No Power	3443	4321	4447
B 36" d x 99 1/2" w x 42" h / 91cm x 253cm x 107cm, No Power	4070	4949	5074
B 36" d x 119 1/2" w x 29" h / 91cm x 304cm x 29cm, No Power	3569	4887	5012
B 36" d x 119 1/2" w x 36" h / 91cm x 304cm x 91cm, No Power	3632	4949	5074
B 36" d x 119 1/2" w x 42" h / 91cm x 304cm x 107cm, No Power	4260	5576	5701

STMA rec single top workshop table (continued)



	Price		
	Studio Foundation Laminata	Linoleum	Studio Veneer
C 48" d x 58" w x 29" h / 122cm x 147cm x 29cm, No Power	3256	4134	4260
C 48" d x 58" w x 36" h / 122cm x 147cm x 91cm, No Power	3318	4196	4321
C 48" d x 58" w x 42" h / 122cm x 147cm x 107cm, No Power	4196	5074	5199
C 48" d x 70" w x 29" h / 122cm x 178cm x 29cm, No Power	3632	4510	4635
C 48" d x 70" w x 36" h / 122cm x 178cm x 91cm, No Power	3695	4573	4698
C 48" d x 70" w x 42" h / 122cm x 178cm x 107cm, No Power	4573	5451	5576
C 48" d x 88" w x 29" h / 122cm x 224cm x 29cm, No Power	3820	4698	4823
C 48" d x 88" w x 36" h / 122cm x 224cm x 91cm, No Power	3883	4761	4887
C 48" d x 88" w x 42" h / 122cm x 224cm x 107cm, No Power	5138	6016	6141
C 48" d x 99 1/2" w x 29" h / 122cm x 253cm x 29cm, No Power	4196	5074	5199
C 48" d x 99 1/2" w x 36" h / 122cm x 253cm x 91cm, No Power	4260	5138	5263
C 48" d x 99 1/2" w x 42" h / 122cm x 253cm x 107cm, No Power	5513	6392	6518
C 48" d x 119 1/2" w x 29" h / 122cm x 304cm x 29cm, No Power	4698	5701	5827
C 48" d x 119 1/2" w x 36" h / 122cm x 304cm x 91cm, No Power	4761	5765	5890
C 48" d x 119 1/2" w x 42" h / 122cm x 304cm x 107cm, No Power	6141	7019	7144

STMB rec ganged single top workshop tables

Product Options

Depth	Width	Height	Power	Surface Finish	Base Finish
A 23" / 58cm	F 163" / 417cm	29 29" / 74cm	N No Power	Studio Foundation Laminate	Fundamental Paint
B 36" / 91cm	G 187" / 475cm	36 36" / 91cm	P Power Cut Out	Linoleum	Fashion Paint
C 48" / 122cm	H 227" / 577cm	42 42" / 107cm		Studio Veneer	

Note For Fashion Paint Finish, add \$58
 For power-cutout of 163", 187", 227" width use Dual Round Power Bump (STYE) Quantity (2), add \$93
 POWER UNIT SOLD SEPARATELY

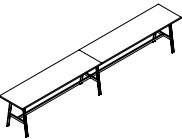

Price

	Studio Foundation Laminate	Linoleum	Studio Veneer
A 23" d x 163" w x 29" h / 58cm x 417cm x 29cm, No Power	4863	6256	6487
A 23" d x 163" w x 36" h / 58cm x 417cm x 91cm, No Power	4978	6371	6603
A 23" d x 163" w x 42" h / 58cm x 417cm x 107cm, No Power	6023	7415	7648
A 23" d x 187" w x 29" h / 58cm x 475cm x 29cm, No Power	5095	6487	6720
A 23" d x 187" w x 36" h / 58cm x 475cm x 91cm, No Power	5211	6603	6835
A 23" d x 187" w x 42" h / 58cm x 475cm x 107cm, No Power	6256	7648	7879
A 23" d x 227" w x 29" h / 58cm x 577cm x 29cm, No Power	5791	6951	7184
A 23" d x 227" w x 36" h / 58cm x 577cm x 91cm, No Power	5906	7067	7300
A 23" d x 227" w x 42" h / 58cm x 577cm x 107cm, No Power	6951	8112	8345
B 36" d x 163" w x 29" h / 91cm x 417cm x 29cm, No Power	5906	7531	7764
B 36" d x 163" w x 36" h / 91cm x 417cm x 91cm, No Power	6023	7648	7879
B 36" d x 163" w x 42" h / 91cm x 417cm x 107cm, No Power	7184	8809	9040
B 36" d x 187" w x 29" h / 91cm x 475cm x 29cm, No Power	6256	7879	8112
B 36" d x 187" w x 36" h / 91cm x 475cm x 91cm, No Power	6371	7995	8228
B 36" d x 187" w x 42" h / 91cm x 475cm x 107cm, No Power	7531	9156	9387
B 36" d x 227" w x 29" h / 91cm x 577cm x 29cm, No Power	6603	9040	9273
B 36" d x 227" w x 36" h / 91cm x 577cm x 91cm, No Power	6720	9156	9387
B 36" d x 227" w x 42" h / 91cm x 577cm x 107cm, No Power	7879	10317	10548
C 48" d x 163" w x 29" h / 122cm x 417cm x 29cm, No Power	7067	8692	8923
C 48" d x 163" w x 36" h / 122cm x 417cm x 91cm, No Power	6928	8553	8785
C 48" d x 163" w x 42" h / 122cm x 417cm x 107cm, No Power	9504	11129	11361
C 48" d x 187" w x 29" h / 122cm x 475cm x 29cm, No Power	7764	9387	9620
C 48" d x 187" w x 36" h / 122cm x 475cm x 91cm, No Power	7277	8901	9133
C 48" d x 187" w x 42" h / 122cm x 475cm x 107cm, No Power	10201	11825	12057
C 48" d x 227" w x 29" h / 122cm x 577cm x 29cm, No Power	8692	10548	10781
C 48" d x 227" w x 36" h / 122cm x 577cm x 91cm, No Power	7973	9598	9830
C 48" d x 227" w x 42" h / 122cm x 577cm x 107cm, No Power	11361	12986	13218

STMD rec split top workshop table

Product Options

Depth	Width	Height	Surface Finish	Base Finish
C 48" / 122cm	A 58" / 147cm	29 29" / 74cm	Studio Foundation Laminate	Fundamental Paint
	B 70" / 178cm	36 36" / 91cm	Linoleum	Fashion Paint
	C 88" / 224cm	42 42" / 107cm	Studio Veneer	
	D 99 1/2" / 253cm			
	E 119 1/2" / 304cm			

Note For Fashion Paint Finish, add \$58
 Use with only Rec Single (STYO) or Multi Edge-Mount Power Accessories (STYR)
 POWER UNIT SOLD SEPARATELY

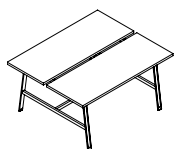

- C 48" d x 58" w x 29" h / 122cm x 147cm x 29cm, No Power
- C 48" d x 58" w x 36" h / 122cm x 147cm x 91cm, No Power
- C 48" d x 58" w x 42" h / 122cm x 147cm x 107cm, No Power
- C 48" d x 70" w x 29" h / 122cm x 178cm x 29cm, No Power
- C 48" d x 70" w x 36" h / 122cm x 178cm x 91cm, No Power
- C 48" d x 70" w x 42" h / 122cm x 178cm x 107cm, No Power
- C 48" d x 88" w x 29" h / 122cm x 224cm x 29cm, No Power
- C 48" d x 88" w x 36" h / 122cm x 224cm x 91cm, No Power
- C 48" d x 88" w x 42" h / 122cm x 224cm x 107cm, No Power
- C 48" d x 99 1/2" w x 29" h / 122cm x 253cm x 29cm, No Power
- C 48" d x 99 1/2" w x 36" h / 122cm x 253cm x 91cm, No Power
- C 48" d x 99 1/2" w x 42" h / 122cm x 253cm x 107cm, No Power
- C 48" d x 119 1/2" w x 29" h / 122cm x 304cm x 29cm, No Power
- C 48" d x 119 1/2" w x 36" h / 122cm x 304cm x 91cm, No Power
- C 48" d x 119 1/2" w x 42" h / 122cm x 304cm x 107cm, No Power

Price

Studio Foundation Laminate	Linoleum	Studio Veneer
3757	4887	5012
3820	4949	5074
4698	5827	5952
4009	5138	5263
4070	5199	5326
4949	6078	6204
4260	5388	5513
4321	5451	5576
5576	6705	6830
4510	5640	5765
4573	5701	5827
5827	6957	7082
5012	6141	6518
5123	6263	6642
6329	7458	7835

STMC rec ganged split top workshop table

Product Options

Depth	Width	Height	Surface Finish	Base Finish
C 48" / 122cm	F 163" / 417cm	29 29" / 74cm	Studio Foundation Laminate	Fundamental Paint
	G 187" / 475cm	36 36" / 91cm	Linoleum	Fashion Paint
	H 227" / 577cm	42 42" / 107cm	Studio Veneer	

Note For Fashion Paint Finish, add \$58
Use with only Rec Single (STYQ) or Multi Edge-Mount Power Accessories (STYR)
POWER UNIT SOLD SEPARATELY

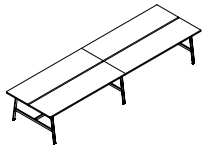

- C 48" d x 163" w x 29" h / 122cm x 417cm x 29cm, No Power
- C 48" d x 163" w x 36" h / 58cm x 417cm x 91cm, No Power
- C 48" d x 163" w x 42" h / 58cm x 417cm x 107cm, No Power
- C 48" d x 187" w x 29" h / 58cm x 475cm x 29cm, No Power
- C 48" d x 187" w x 36" h / 58cm x 475cm x 91cm, No Power
- C 48" d x 187" w x 42" h / 58cm x 475cm x 107cm, No Power
- C 48" d x 227" w x 29" h / 58cm x 577cm x 29cm, No Power
- C 48" d x 227" w x 36" h / 58cm x 577cm x 91cm, No Power
- C 48" d x 227" w x 42" h / 58cm x 577cm x 107cm, No Power

Price

Studio Foundation Laminate	Linoleum	Studio Veneer
7879	9968	10201
7995	10084	10317
10317	12405	12637
8345	10432	10665
8459	10548	10781
10781	12869	13101
9273	11361	12057
9387	11476	12173
11709	13797	14494

STYQ rec single power accessory

Product Options

Style	Wire Option	Finish
A 1 Simplex, 2 USB-A	P North American Plug	52 Ebony Coordinate
	H Hardwire	74 Storm White Coordinate

Note 10' Power Cable

Price



- | | North America | Hardwire |
|----------------------|---------------|----------|
| A 1 Simplex, 2 USB-A | 806 | 806 |

STYR rec multi power accessory

Product Options

Style	Wire Option	Finish
2 Dual Unit - Both 1 Simplex, 2 USB-A	P North American Plug	52 Ebony Coordinate
4 Quad Unit - All 1 Simplex, 2 USB-A		74 Storm White Coordinate

Note North American plug only
10' Power Cable

Price



- 2 Dual Unit - Both 1 Simplex, 2 USB-A
- 4 Quad Unit - All 1 Simplex, 2 USB-A

North America

1502
2894

sly

features

The Sly Table series is illusory, tricking the viewer's eye. Although the table surface appears to be angled, it is perfectly level.

Sly is a crafted, light-scale occasional table series with a simple, unbalanced approach. The edge detailing creates a sense of non-conformity to traditional norms. Surface materials include linoleum, laminate, veneer and back-painted glass. An exposed plywood edge detail is featured with linoleum tops.

The unique base design incorporates three diameters and heights, comprising Side, Occasional and Coffee Tables. Various base sizes increase visual interest in a setting when multiple Sly tables are specified, and enable the overlapping and nesting of tables.

The materiality of the inset top, in combination with an expansive base palette, allows designers to create iconic lounge, greeting or public settings.

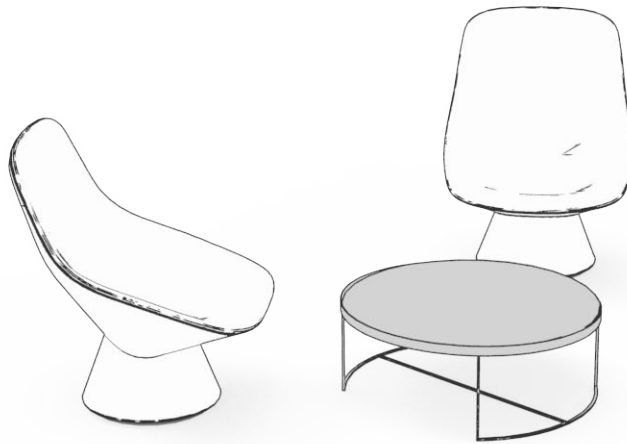

dimensions

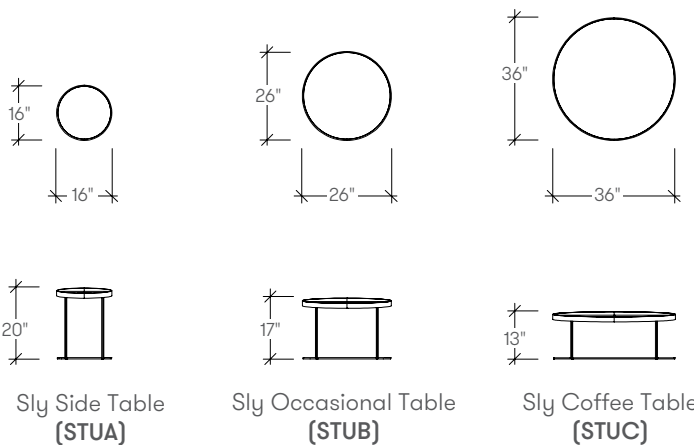

sly

planning

A variety of configurations can be achieved with Sly Tables, allowing for various configurations. The following typical demonstrate the versatility that can be achieved.

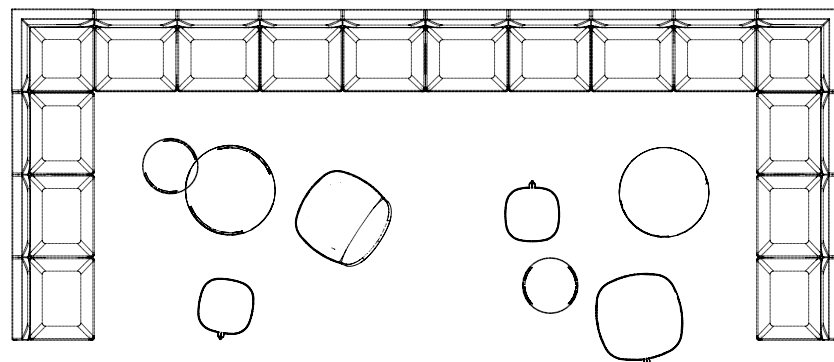
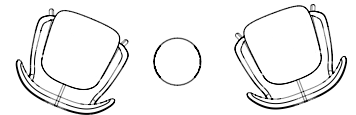
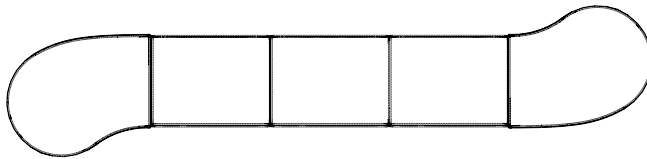
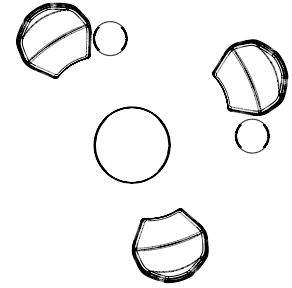
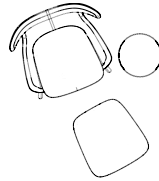
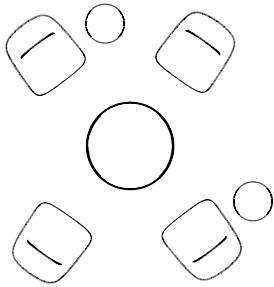

STUA sly side table

Product Options

Surface Finish	Base Finish
Studio Foundation Laminate	Fundamental Paint
Backpainted Glass	Fashion Paint
Linoleum	
Studio Veneer	

Note For Fashion Paint Finish, add \$41



Price

Studio Foundation Laminate	Backpainted Glass	Linoleum	Studio Veneer
1217	1242	1442	1492

STUB sly occasional table

Product Options

Surface Finish	Base Finish
Studio Foundation Laminate	Fundamental Paint
Backpainted Glass	Fashion Paint
Linoleum	
Studio Veneer	

Note For Fashion Paint Finish, add \$41



Price

Studio Foundation Laminate	Backpainted Glass	Linoleum	Studio Veneer
1616	1742	1817	1866

STUC sly coffee table

Product Options

Surface Finish	Base Finish
Studio Foundation Laminate	Fundamental Paint
Backpainted Glass	Fashion Paint
Linoleum	
Studio Veneer	

Note For Fashion Paint Finish, add \$41

Price

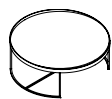

Studio Foundation Laminate	Backpainted Glass	Linoleum	Studio Veneer
1942	2241	2291	2341



accessories

Pillows	4 0 0
Power Accessories	4 0 4

pillows

features

Pillows accessorize soft seating by adding comfort and a residential quality to the piece. Filled with a down alternative fiber which allows a consistent fill and provides relief for those allergic to the traditional down feather. The pillows can be upholstered in contrasting fabrics to allow full customization.

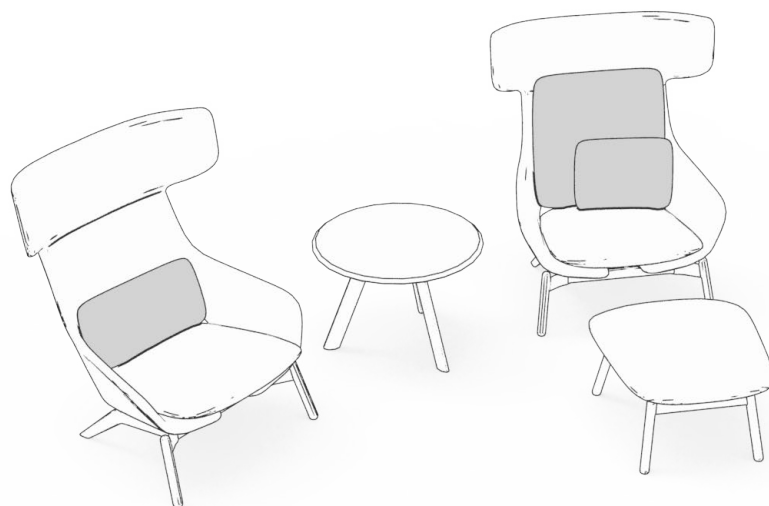

kalm chair shown

dimensions

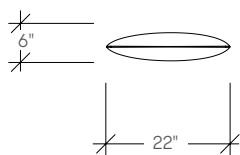

Pillow, 10.5 x 22
Knife Edge Lumbar
(PLW1022)

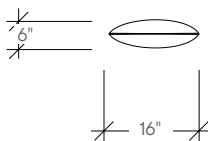

Pillow, 12 x 16 Knife
Edge Lumbar
(PLW1216)

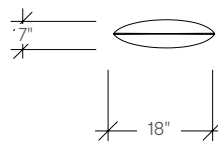

Pillow, 18 x 18 Knife
Edge Square
(PLW1818)

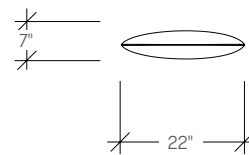

Pillow, 22 x 22 Knife
Edge Square
(PLW2222)

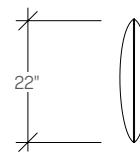
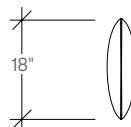
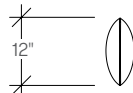
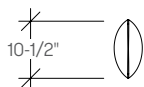

specifying pillow finishes

Pillows permit a wide range of combinations that vary dependent of the configuration specified. The following demonstrates the order that must be selected.

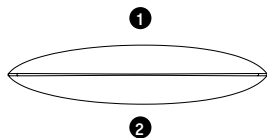

- 1 Side A Finish
Select Side A upholstery
- 2 Side B Finish
Select Side B upholstery

specification example

PLW1216 Pillow, 12 x 16 Knife Edge Lumbar	
1 Side A upholstery Gr.3	254
2 Side B upholstery Gr.5	60
Total:	\$314

PLW1818 Pillow, 18 x 18 Knife Edge Square	
1 Side A upholstery Gr.4	307
2 Side B upholstery Gr.6	67
Total:	\$375

COM/COL material requirement

Yardage is based on a non-patterned fabric. Additional yardage may be required for pattern repeats and the matching required. Leather yield may be affected by the quality of the COL. However, variance in the size of the hides will not affect the yield.

SINGLE UPHOLSTERY	COM [yards]	COL [sq. ft.]
12x16 Pillow	3/4	2-1/4
10x22 Pillow	1	3
18x18 Pillow	1	3
22x22 Pillow	1	3

PLW1022 pillow, 10.5 × 22 knife edge lumbar

Product Options

Side A Upholstery Finish						Side B Upholstery Finish					
Fabric						Fabric					

Side A Price

COM	Gr.1	Gr.2	Gr.3	Gr.4	Gr.5	Gr.6	Gr.7	Gr.8	Gr.9	Gr.10	Gr.11
224	247	258	267	277	284	291	297	305	313	320	329
Gr.12	Gr.13	Gr.14	Gr.15	Gr.16	Gr.17	Gr.18	Gr.19	Gr.20			
340	353	365	378	391	405	418	430	443			

Side B Price

COM	Gr.1	Gr.2	Gr.3	Gr.4	Gr.5	Gr.6	Gr.7	Gr.8	Gr.9	Gr.10	Gr.11
0	23	34	43	53	60	67	73	81	89	96	106
Gr.12	Gr.13	Gr.14	Gr.15	Gr.16	Gr.17	Gr.18	Gr.19	Gr.20			
116	129	142	154	167	181	194	206	219			

PLW1216 pillow, 12 × 16 knife edge lumbar

Product Options

Side A Upholstery Finish						Side B Upholstery Finish					
Fabric						Fabric					

Side A Price

COM	Gr.1	Gr.2	Gr.3	Gr.4	Gr.5	Gr.6	Gr.7	Gr.8	Gr.9	Gr.10	Gr.11
211	234	245	254	264	271	278	284	292	300	307	317
Gr.12	Gr.13	Gr.14	Gr.15	Gr.16	Gr.17	Gr.18	Gr.19	Gr.20			
327	340	353	365	378	392	405	418	430			

Side B Price

COM	Gr.1	Gr.2	Gr.3	Gr.4	Gr.5	Gr.6	Gr.7	Gr.8	Gr.9	Gr.10	Gr.11
0	23	34	43	53	60	67	73	81	89	96	106
Gr.12	Gr.13	Gr.14	Gr.15	Gr.16	Gr.17	Gr.18	Gr.19	Gr.20			
116	129	142	154	167	181	194	206	219			

PLW1818 pillow, 18 × 18 knife edge square

Product Options

Side A Upholstery Finish

Fabric

Side B Upholstery Finish

Fabric

Side A Price

COM	Gr.1	Gr.2	Gr.3	Gr.4	Gr.5	Gr.6	Gr.7	Gr.8	Gr.9	Gr.10	Gr.11
254	277	288	297	307	314	321	327	335	343	350	360
Gr.12	Gr.13	Gr.14	Gr.15	Gr.16	Gr.17	Gr.18	Gr.19	Gr.20			
370	383	396	408	421	435	448	461	473			

Side B Price

COM	Gr.1	Gr.2	Gr.3	Gr.4	Gr.5	Gr.6	Gr.7	Gr.8	Gr.9	Gr.10	Gr.11
0	23	34	43	53	60	67	73	81	89	96	106
Gr.12	Gr.13	Gr.14	Gr.15	Gr.16	Gr.17	Gr.18	Gr.19	Gr.20			
116	129	142	154	167	181	194	206	219			

PLW2222 pillow, 22 × 22 knife edge square

Product Options

Side A Upholstery Finish

Fabric

Side B Upholstery Finish

Fabric

Side A Price

COM	Gr.1	Gr.2	Gr.3	Gr.4	Gr.5	Gr.6	Gr.7	Gr.8	Gr.9	Gr.10	Gr.11
291	314	325	334	345	351	358	364	372	380	387	397
Gr.12	Gr.13	Gr.14	Gr.15	Gr.16	Gr.17	Gr.18	Gr.19	Gr.20			
407	420	433	445	458	472	485	498	510			

Side B Price

COM	Gr.1	Gr.2	Gr.3	Gr.4	Gr.5	Gr.6	Gr.7	Gr.8	Gr.9	Gr.10	Gr.11
0	23	34	43	53	60	67	73	81	89	96	106
Gr.12	Gr.13	Gr.14	Gr.15	Gr.16	Gr.17	Gr.18	Gr.19	Gr.20			
116	129	142	154	167	181	194	206	219			

power accessories



1 simplex,
1 pass through



1 simplex,
2 USB-A

Power Accessories Single Round Power Bump
(STYD)



Unit 1, 1 Power, 2 USB-A
Unit 2, 1 Power, 1 Pass Through

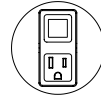

Power Accessories Dual Round Power Bump
(STYE)

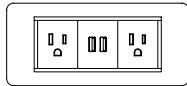

Unit 1, 2 Simplex, 2 USB-A

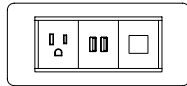

Unit 2, 1 Simplex, 2 USB-A,
1 Pass Through

Power Accessories Dual Rectangular Power Core
(STYZ)

Power Units are sold separately. Wire management included in power cut out if selected.

STYD power accessories single round power bump

Product Options

Style	Wire Option	Power Finish
A 1 Simplex, 1 Pass Through	P North American Plug	8B Ebony Coordinate
B 1 Simplex, 2 USB-A	H Hardwire	7Y Storm White Coordinate

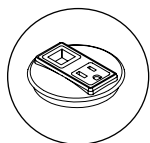

- A 1 Simplex, 1 Pass Through
- B 1 Simplex, 2 USB-A

Price

	North American Plug	Hardwire
A	261	327
B	367	435

STYE power accessories dual round power bump

Product Options

Style	Wire Option	Power Finish
E Unit 1 / 1 Power, 2 USB-A Unit 2 / 1 Power, 1 Pass Through	P North American Plug	8B Ebony Coordinate
F Unit 1 / 1 Power, 2 USB-A Unit 2 / 1 Power, 2 USB-A	H Hardwire	7Y Storm White Coordinate

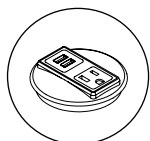

- E Unit 1 / 1 Power, 2 USB-A. Unit 2 / 1 Power, 1 Pass Through
- F Unit 1 / 1 Power, 2 USB-A. Unit 2 / 1 Power, 2 USB-A

Price

	North American Plug	Hardwire
E	688	728
F	688	728

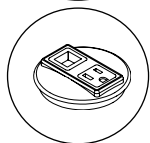

STYZ power accessories dual rectangular power core

Product Options

Style	Wire Option	Power Finish
C 1 Unit 1 / 2 Simplex, 2 USB-A Unit 2 / 1 Simplex, 2 USB-A, 1 Pass Through	P North American Plug	52 Ebony Coordinate
	H Hardwire	74 Storm White Coordinate

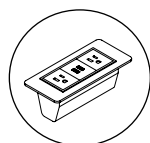

- C 1 Unit 1 / 2 Simplex, 2 USB-A Unit 2 / 1 Simplex, 2 USB-A, 1 Pass Through

Price

	North American Plug	Hardwire
C	1238	1277

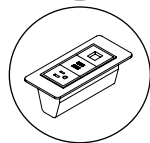



technical

Edge Trims	4 0 9
Grain Direction	4 1 0
Surface Sections	4 1 3
Power Accessories	4 1 4
Grommets	4 1 5
Linking Power	4 2 2
Linking Power on Seating	4 2 5
Linking Power on Tables	4 2 4
Power Management on Seating	4 2 5
Power Management on Tables	4 2 6

edge trims

The following outlines the edge trims available on Studio TK tables

Foundation Laminate

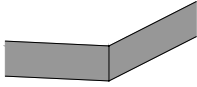

Flat Trim

- Cesto (3/4" thick)
- Fractals Nook (3/4" thick)
- Clique (3/4" thick)
- Rec (1" thick)
- Sly (1/2" thick)

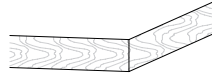

Straight Exposed Plywood

- Vettore (1/2" thick)



60° Full Knife Edge

- Bevy (1" thick)
- Havn (1" thick)

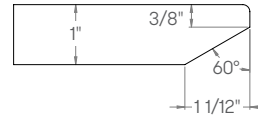

Knife Edge dimensional information for Studio laminate and veneer tops

Natural Veneer

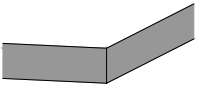

Flat Trim

- Cesto (3/4" thick)
- Fractals Nook (3/4" thick)
- Clique (3/4" thick)
- Rec (1" thick)
- Sly (1/2" thick)

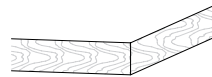

Straight Exposed Plywood

- Vettore (1/2" thick)



60° Full Knife Edge

- Bevy (1" thick)
- Havn (1" thick)

Solid Surface

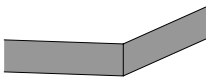

Solid Surface

- Bevy (1/2" thick)

Solid Core Laminate

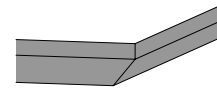

45° Knife Edge Solid Black Core

- Mari-Sol (1/2" thick)

Linoleum

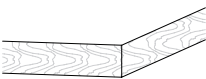

Straight Exposed Plywood

- Rec (1" thick)
- Sly (1/2" thick)

Glass

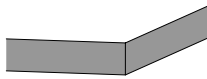

Glass

- Bevy (1/2" thick)
- Sly (1/2" thick)

grain direction

The following outlines the grain direction on Studio TK tables and includes:

- Foundation Laminate (woodgrain patterns)
- Flintwood (Standard or Cathedral)
- Natural Veneer

bevy

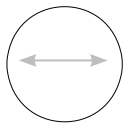

Round

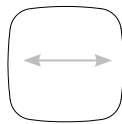

Square



Rectangular

cesto



Side

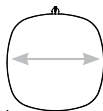

Coffee



Rectangular

clique

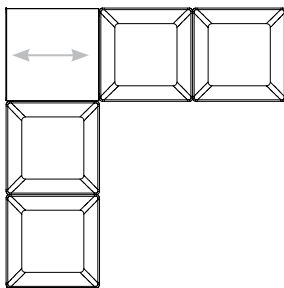

Square

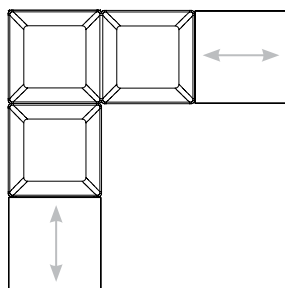

artifort compass

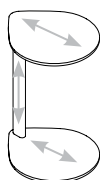

grain direction

fractals nook

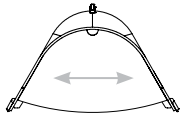

Table

freehand



Side

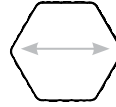

Occasional

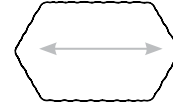

Occasional

havn



Round



Square

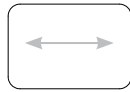

Rectangular

rec

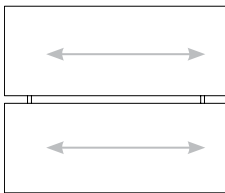

All Rectangular Tops

sly

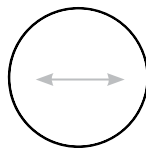

Round

NOTE: Natural Veneer wood species offer unique texture and grain. Due to the natural properties of wood, grain pattern and finish color variation can be expected. Studio TK provides a coordinated color match between individual product lines.

grain direction

vettore

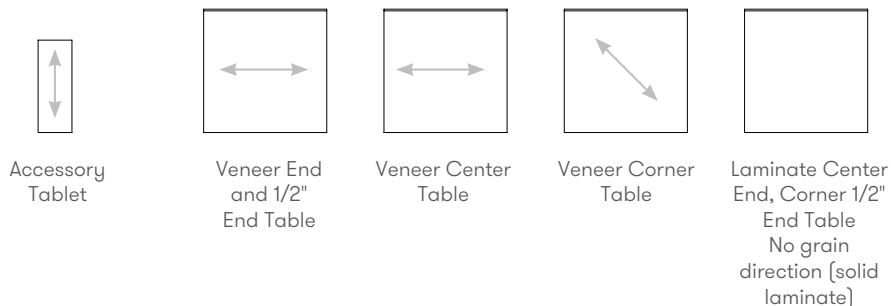

finishes

artifort compass

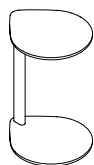

Artifort Compass Tables have an oil finish and are open pore. Compass Basque White Oak (BU) and Compass Truffle (DZ) are coordinating finishes to Studio TK's Basque White Oak (BU) and Truffle (DZ).

fabric direction

trine

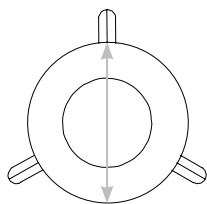

Fabric runs perpendicular between two legs and back to the singular leg.

surface sections

The following outlines the number of surface sections for Studio TK tables.

bevy

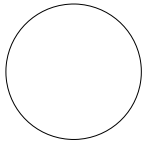

Circular
24" - 60" depth
One section

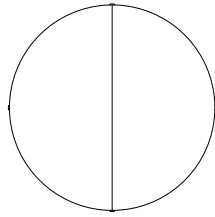

Circular
72" - 84" depth
Two sections

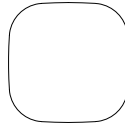

Square
All sizes
One section

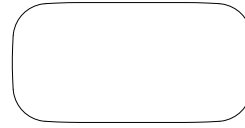

Rectangular
All sizes
One section

rec

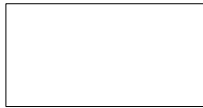

Workshop
All sizes
One section

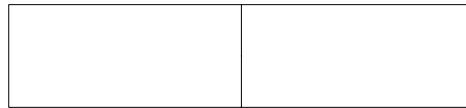

Ganged Workshop
All sizes
Two sections

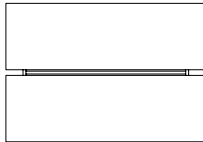

Split Top Workshop
All sizes
Two sections



Ganged Split Top Workshop
All sizes
Four section

power accessories

Power accessories for Studio TK tables are specified separately.

Power cut outs include wire management.

Power accessories are available in two styles:

- With a 10' power cord
- For hardwiring

POWER UNITS SOLD SEPARATELY. Wire management included in power cut out if selected.

round power bump



1 simplex,
1 pass Through



1 simplex,
2 USB-A



Unit 1, 1 Power, 2 USB-A
Unit 2, 1 Power, 1 Pass Through
(includes connector which links
the power bumps together)

Power Accessories Single Round Power Bump
(STYD)

Power Accessories Dual Round Power Bump
(STYE)

rectangle power core

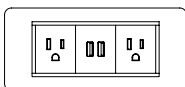

Unit 1, 2 Simplex, 2 USB-A

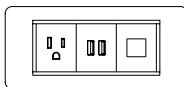

Unit 2, 1 Simplex, 2 USB-A,
1 Pass Through

Power Accessories Dual Rectangular Power Core
(STYZ)

grommets

The following outlines the grommet locations on Studio TK tables.

- Power Bumps for all tables must be specified separately
- Tables with one grommet will be centered

bevy grommet locations

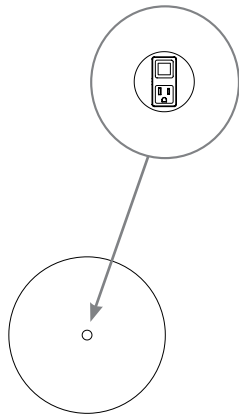

Round
(excluding STED Round
Conference)

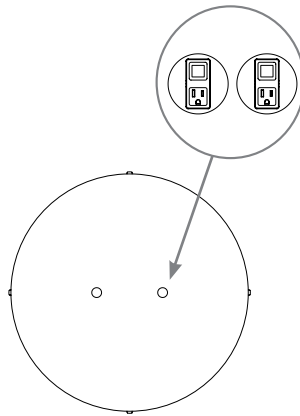

Round Conference Leg
(Grommet Style D)
(STED)

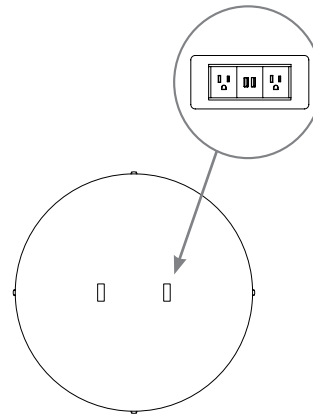

Round Conference Leg
(Grommet Style Z)
(STED)

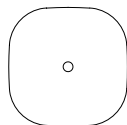

Square
(All square Bevy tables)

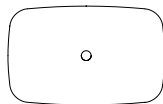

Rectangular Coffee and
Booth Pedestal
(STEB/STET)

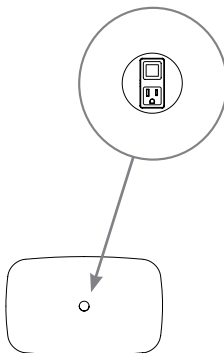

Rectangular
(All rectangular Bevy
tables with the exception
of the Rectangular
Work Y and Conference Y
STETK/STETL)

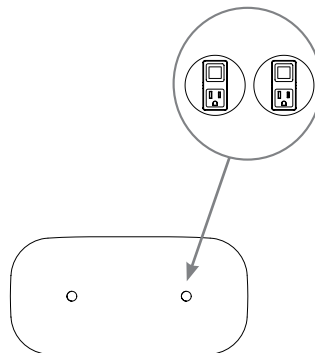

Rectangular Work Y
and Conference Y
(Grommet style D)
(STETK/STETL)

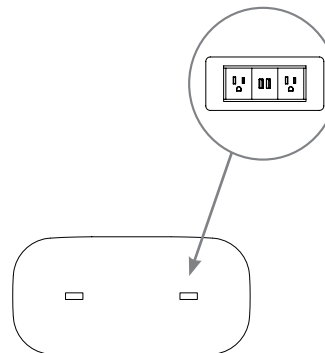

Rectangular Work Y
and Conference Y
(Grommet style Z)
(STETK/STETL)

grommets

bevy grommet dimensions

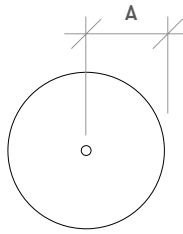

All Round Tables
(excluding Round Conference STETD)

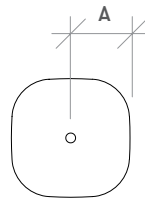

All Square Tables

Table Size (Dia./Depth)	Edge of Table to Grommet (A) (Width)
30"	15"
36"	18"
42"	21"
48"	24"
60"	30"

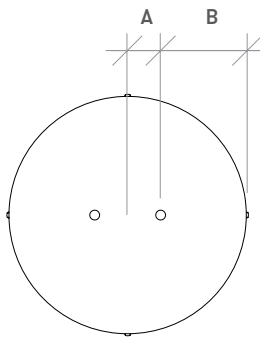

Round Conference Leg
(Grommet Style D)
(STETD)

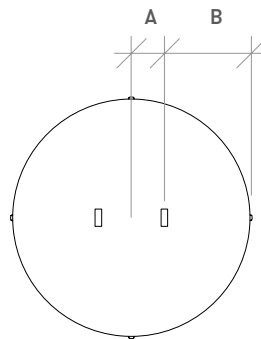

Round Conference Leg
(Grommet Style Z)
(STETD)

Table Size (Dia.)	Center of Table to Grommet (A) (Width)	Edge of Table to Grommet (B) (Width)
72"	10"	26"
84"	16"	27"

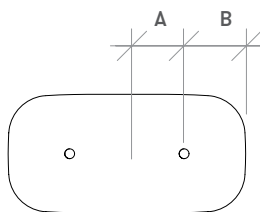

Rectangular Coffee and Booth Pedestal
(Grommet Style D)
(STETB/STETT)

Table Size (Width)	Center of Table to Grommet (A) (Width)	Edge of Table to Grommet (B) (Width)
48"	n/a"	24"
60"	11"	19"
72"	17"	19"
84"	19"	23"
96"	25"	23"
119"	31"	31"

grommets

borough grommet locations



borough grommet dimensions



Borough Tables
(STHTA/STHAB)

Table Size (Width x Depth)	Edge of Table to Grommet (A) (Width)
15" x 33"	8"

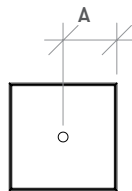

Borough Tables
(STHTA/STHAB)

Table Size (Width x Depth)	Edge of Table to Grommet (A) (Width)
33" x 33"	16"

grommets

fractals nook grommet locations

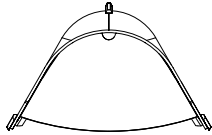

fractals nook grommet dimensions

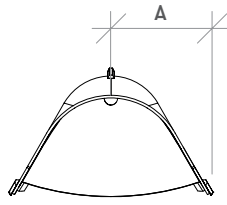

Fractals Nook
(STFNA)

Table Size (Width x Depth)	Center of Table to Grommet (A) (Width)
40" x 22"	20"

grommets

rec grommet locations

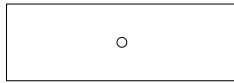

Single Top Workshop
(STMA)
58" - 88" widths



Single Top Workshop
(STMA)
99-1/2" - 119-1/2" widths

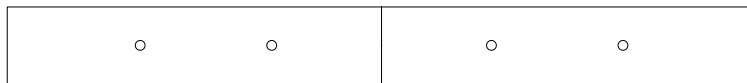

Ganged Single Top Workshop
(STMB)
163" - 227" widths

rec grommet dimensions

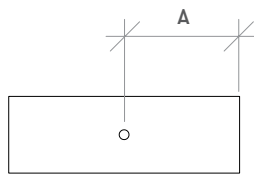

Single Top Workshop Table
(STMA)

Table Size (Width)	Edge of Table to Grommet (A) (Width)
58"	29"
70"	35"
88"	44"

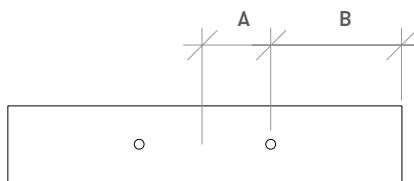

Single Top Workshop Table
(STMA)

Table Size (Width)	Center of Table to Grommet (A) (Width)	Edge of Table to Grommet (B) (Width)
99 1/2"	17"	33"
119 1/2"	20"	40"

grommets

rec grommet dimensions

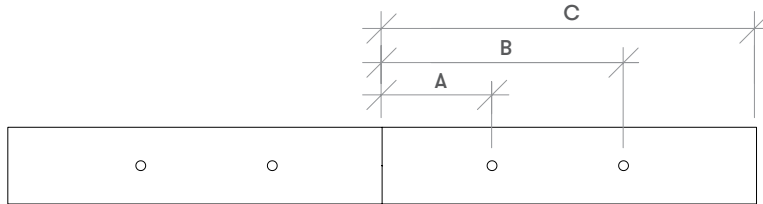

Ganged Single Top Workshop Table
(STMBA)

Table Size (Width)	Center of Table to Grommet (A) (Width)	Center of Table to Grommet (B) (Width)	Edge of Table to Center (C) (Width)
163"	23"	52"	82"
187"	33"	73"	114"

grommets

vettore grommet locations

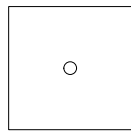

Center Tables
(STXT)

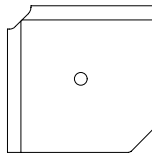

Corner Table
(STXT)

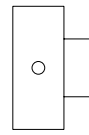

End and 1/2" End Table
(STXT)

vettore grommet dimensions

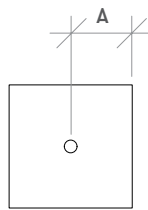

Center Table
(STXTA/STXTB/STXTC)

Table Size (Width)	Edge of Table to Grommet (A) (Width)
29" x 29"	18"

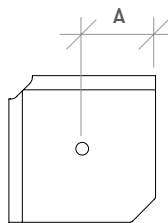

Corner Table
(STXTD)

Table Size (Width)	Edge of Table to Grommet (A) (Width)
35" x 35"	17"

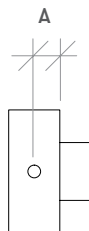

1/2" End Table
(STXTE)

Table Size (Width)	Edge of Table to Grommet (A) (Width)
29" x 12"	6"

linking power

Power Bumps and Power Cores are available in two configurations:

- One Power Bump (requires one grommet cut out)
Includes a 10' power cord or hardwire connection
- Two Power Bumps or Power Cores (requires two grommet cut outs)
Includes a linking connection and includes a 10' power cord or hardwire connection

Power Accessories Single Round Power Bump (STYD)

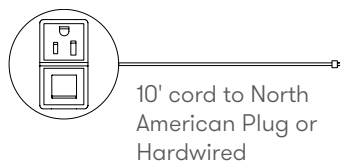

Power Accessories Dual Round Power Bump (STYE)

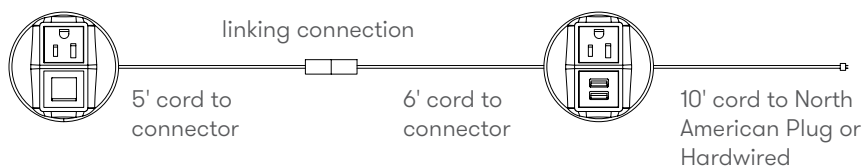

Power Accessories Dual Rectangular Power Core (STYZ)

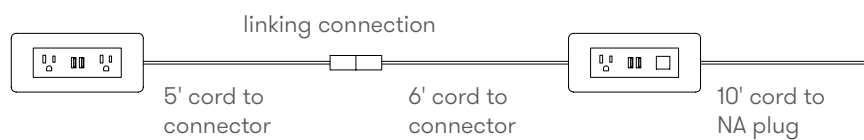

linking power on seating

clique

The following accessories are available on Clique seating.



Single Power Accessory **(STYC)**
- One unit with 1 Power/2 USB-A

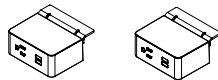

Dual Power Accessory **(STYB)**
- Two units with 1 Power/2 USB-A



USB Power Hub Accessory **(STYU)**
- One unit with 2 USB-A
- Available to specify 1, 2 or 4 USB-A units

The following outlines applications with Clique Power Accessories.

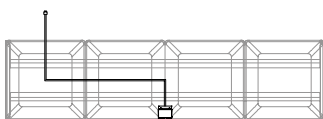

Single Bench Applications
- Single Power Accessory **(STYC)** is recommended
- **STYB** is possible if more power is desired

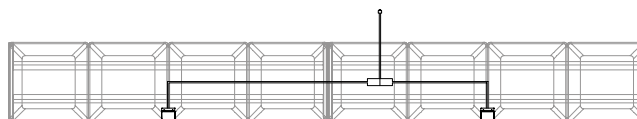

Side by Side Single Bench Applications
- A dual power accessory **(STYB)** is recommended
- Includes a junction box to allow the power to run from bench to bench

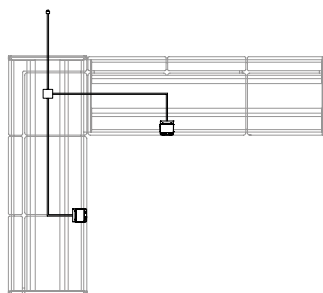

L-Shape with Bench Dual Power Application
- A dual power accessory **(STYB)** is recommended
- Includes a junction box to allow the power to run from a bench to bench

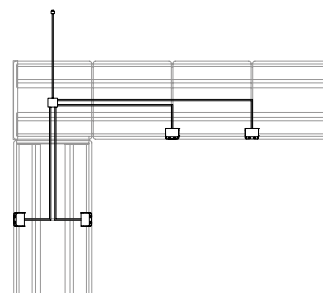

L-Shape with Bench USB Application
- USB Power Hub accessory with 4 units is recommended

linking power on tables

rec

The following power accessories are available on Rec tables. Each configuration features a single 10' power cord.

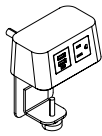

Single Power Accessory **(STYQ)**
- Single power unit with 1 Simplex and 2 USB-A

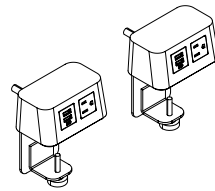

Dual Power Accessory **(STYR2)**
- Two power units each with 1 Simplex and 2 USB-A

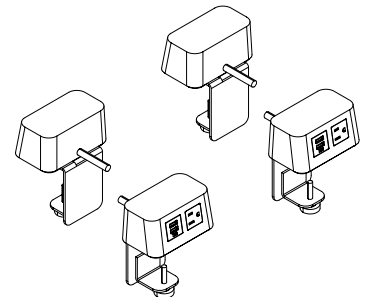

Quad Dual Power Accessory **(STYR4)**
- Four power units each with 1 Simplex and 2 USB-A

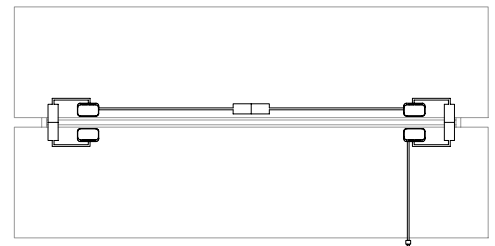
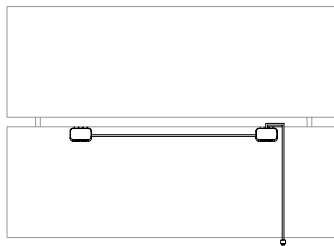
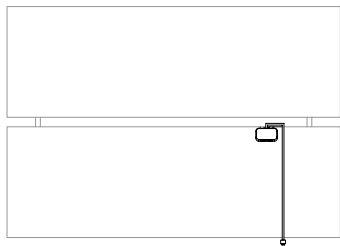

power management on seating

Power management is available on Studio TK seating.

clique

Cable Managers are magnetic and can be re-positioned anywhere on the underside of a bench.

Power Routing

- 1 Magnetic clip that is attached under the bench

Clique Power Accessories (STYB and STYC) come with 4 black plastic magnetic clips.

Clique USB Hub Power Accessory (STYU) is a white plastic clip that is attached with a screw to the underside of the seat pan.

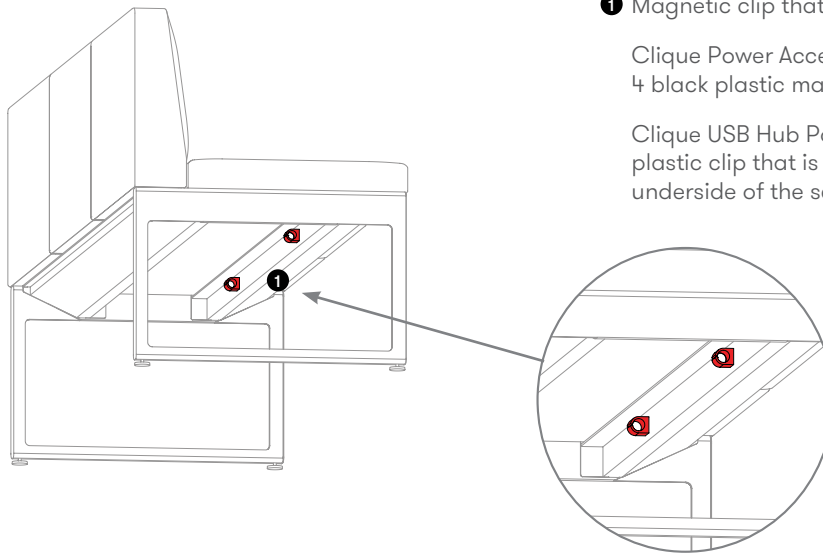

vettore

Cable Managers are magnetic and can be re-positioned anywhere on the underside of a bench.

Power Routing

- 1 Magnetic clip that is attached under the bench

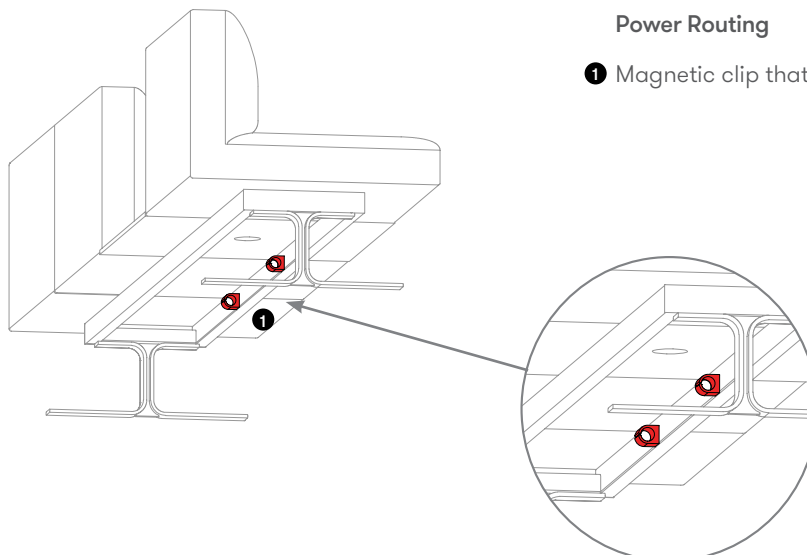

power management on tables

bevy occasional and work pedestal tables

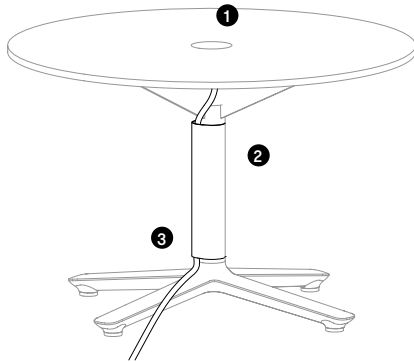

Power Routing

- ❶ Power is routed from a Power Hub on the worksurface.
- ❷ A zippered felt basket below the worksurface provides easy access cord storage.
- ❸ The power cord routes down the table leg with a wire manager that attaches to the center column. The wire manager is cut to length based on the table height.

bevy work table

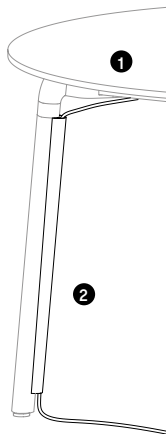

Power Routing

- ❶ Power is routed from the Power Hub on the worksurface down the leg of the table with wire management that attaches to a leg.
- ❷ Wire manager is cut to length based on the height of the table.

bevy table finishes

The wire manager is ABS plastic and coordinates with Very White and Granite.

Very White wire manager will only be used when a Very White base is ordered. All other base finishes have a Granite wire manager.

power management on tables

fractals nook

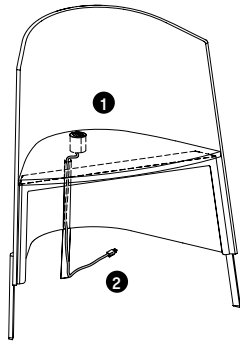

Power Routing

- 1 Power is routed from the Power Hub on the worksurface down one leg of the table through a wire manager cover.
- 2 Wire manager has an adhesive backing and attaches to the leg.

The wire manager is Black ABS plastic.

power management on tables

rec

Cable Managers are magnetic and can be positioned anywhere on the metal structure of the table:

- Included when a power cut out is specified
- Available for single and split tops
- Single Tops accommodate the STYD and STYE Power Bumps
 - 58", 70", 88" include 4 cable managers
 - 99" and 119" include 6 cable managers
 - 163", 187", and 227" include 12 cable managers
- Split Tops accommodate the STYQ and STYR Power Bumps
 - Single power units include 4 cable managers
 - Dual power units include 6 cable managers
 - Quad power units include 12 cable managers

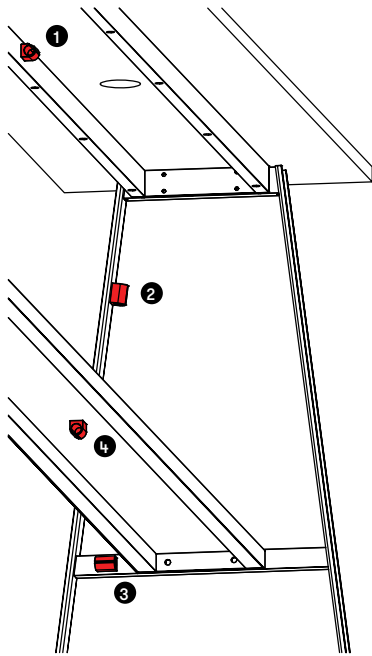

Magnetic cable managers are finished in Black.

Power Routing

- 1 Place at least one magnetic manager on the sub-top rails to ensure cable is not visible underneath top.
- 2 Place at least one magnetic manager on the inside of the table leg to route the power cord down the leg. If power monument is located at one table end you may use two managers here. (Inside of leg is recommended however you could also place on outside of leg.)
- 3 Place one magnetic manager on the cross beam of the leg assembly to either go to the floor (if monument is at end of table) or to route to center manager.
- 4 Place one magnetic manager directly above floor power monument (if between table legs) to route cable to the floor.



finishes + materials

textiles (continued)

The following chart outlines the fabrics that are available for use on studio tk seating and screens.

	Fabric Vendor	kalm	kuskoa	kuskoa bi	lasai	libelle	lite wall	nina	pala	petal	pico	pillow accessories	qui	santé	trine	vettore
Grade 1																
Bitstream (*)	Luum															
Fundamentals	Luum															
Heather Tech	Luum															
Magnify	Luum															
Stimuli	Luum															
Grade 2																
Actuate	Luum															
Artopia	Luum															
Complect	Luum															
Complement	Luum															
Cross Dye	Luum															
Crossgrain	Luum															
Decoy	Luum															
Digi Tweed	Luum															
Graviton	Luum															
Intone (*)	Luum															
Megacheck	Luum															
Percept	Luum															
Ultra Durable (*) (**) (***)	Luum															
Grade 3																
Ample	Luum															
Beaded Stripe	Luum															
Biotope	Luum															
Doyenne (*)	Luum															
Ecotone <small>TEMPORARY HOLD</small>	Luum															
Fine Grain (*) (**)	Luum															
Intraweb	Luum															
Manner	Maharam															
Marl Cloth	Luum															
Meld	Maharam															
Messenger	Maharam															
Metaphor	Maharam															
Metric	Maharam															
Milieu	Luum															
Murmur (*)	Maharam															
Muse (*)	Maharam															
Situ	Luum															
Superspun <small>TEMPORARY HOLD</small>	Luum															
Textured Map	Luum															
Twisted Tweed	Luum															

Note

* Bleach Cleanable ** Coated *** AM Antimicrobial

- studio tk reserves the right, based on fabric or leather selected, to add well-placed seams to units where size, fabric direction, and fabric elasticity interfere with the high quality standards studio tk strives to achieve.

textiles

The following chart outlines the fabrics that are available for use on studio tk seating and screens.

	Fabric Vendor	aventura	beso	borough	borough pillows	cesto poufs	cesto tables	clip	clique	cover	dual	F500 series	fractals	havn	infinito	jima	
Grade 4																	
Brindle (*)	Maharam	Available	Not Available	Available	Available	Available	Available	Available	Available	Available	Available	Available	Available	Available	Available	Available	Available
Grid State	Luum	Available	Available	Available	Available	Available	Available	Available	Available	Available	Available	Available	Available	Available	Available	Available	Available
Elastic Wool	Luum	Available	Available	Available	Available	Available	Available	Available	Available	Available	Available	Available	Available	Available	Available	Available	Available
Formwork	Luum	Available	Available	Available	Available	Available	Available	Available	Available	Available	Available	Available	Available	Available	Available	Available	Available
High Frequency	Luum	Available	Available	Available	Available	Available	Available	Available	Available	Available	Available	Available	Available	Available	Available	Available	Available
Interstice	Luum	Available	Available	Available	Available	Available	Available	Available	Available	Available	Available	Available	Available	Available	Available	Available	Available
Lariat (*) (**)	Maharam	Available	Available	Available	Available	Available	Available	Available	Available	Available	Available	Available	Available	Available	Available	Available	Available
Mantle	Maharam	Available	Available	Available	Available	Available	Available	Available	Available	Available	Available	Available	Available	Available	Available	Available	Available
Medium	Maharam	Available	Available	Available	Available	Available	Available	Available	Available	Available	Available	Available	Available	Available	Available	Available	Available
Merit	Maharam	Available	Available	Available	Available	Available	Available	Available	Available	Available	Available	Available	Available	Available	Available	Available	Available
Meta Texture (*) (**)	Luum	Available	Available	Available	Available	Available	Available	Available	Available	Available	Available	Available	Available	Available	Available	Available	Available
Mode	Maharam	Available	Available	Available	Available	Available	Available	Available	Available	Available	Available	Available	Available	Available	Available	Available	Available
Modulus (*)	Luum	Available	Available	Available	Available	Available	Available	Available	Available	Available	Available	Available	Available	Available	Available	Available	Available
Velvet Underground	Luum	Available	Available	Available	Available	Available	Available	Available	Available	Available	Available	Available	Available	Available	Available	Available	Available
Grade 5																	
Adage	Luum	Available	Available	Available	Available	Available	Available	Available	Available	Available	Available	Available	Available	Available	Available	Available	Available
Cult Classic	Luum	Available	Available	Available	Available	Available	Available	Available	Available	Available	Available	Available	Available	Available	Available	Available	Available
Keen	Maharam	Available	Available	Available	Available	Available	Available	Available	Available	Available	Available	Available	Available	Available	Available	Available	Available
Ledger (**)	Maharam	Available	Available	Available	Available	Available	Available	Available	Available	Available	Available	Available	Available	Available	Available	Available	Available
Monotex (*) (**)	Luum	Available	Available	Available	Available	Available	Available	Available	Available	Available	Available	Available	Available	Available	Available	Available	Available
Particulate	Luum	Available	Available	Available	Available	Available	Available	Available	Available	Available	Available	Available	Available	Available	Available	Available	Available
Point Set (*)	Luum	Available	Available	Available	Available	Available	Available	Available	Available	Available	Available	Available	Available	Available	Available	Available	Available
Refraction	Luum	Available	Available	Available	Available	Available	Available	Available	Available	Available	Available	Available	Available	Available	Available	Available	Available
Sort (*) (**)	Maharam	Available	Available	Available	Available	Available	Available	Available	Available	Available	Available	Available	Available	Available	Available	Available	Available
Stature (*) (**)	Maharam	Available	Available	Available	Available	Available	Available	Available	Available	Available	Available	Available	Available	Available	Available	Available	Available
Subdivide	Luum	Available	Available	Available	Available	Available	Available	Available	Available	Available	Available	Available	Available	Available	Available	Available	Available
Willow (*)	Maharam	Available	Available	Available	Available	Available	Available	Available	Available	Available	Available	Available	Available	Available	Available	Available	Available

Note

* Bleach Cleanable ** Coated *** AM Antimicrobial

- studio tk reserves the right, based on fabric or leather selected, to add well-placed seams to units where size, fabric direction, and fabric elasticity interfere with the high quality standards studio tk strives to achieve.

textiles (continued)

The following chart outlines the fabrics that are available for use on studio tk seating and screens.

	Fabric Vendor	kalm	kuskoa	kuskoa bi	lasai	libelle	lite wall	nina	pala	petal	pico	pillow accessories	qui	santé	trine	vettore
Grade 4																
Brindle (*)	Maharam	Available	Not Available	Not Available	Not Available	Available	Not Available	Not Available	Not Available	Not Available	Not Available	Available	Not Available	Not Available	Not Available	Not Available
Grid State	Luum	Not Available	Available	Not Available	Not Available	Not Available	Not Available	Available	Available	Not Available	Not Available	Available	Not Available	Not Available	Not Available	Not Available
Elastic Wool	Luum	Not Available	Not Available	Not Available	Not Available	Not Available	Not Available	Not Available	Not Available	Available	Available	Available	Not Available	Not Available	Not Available	Not Available
Formwork	Luum	Available	Available	Not Available	Not Available	Not Available	Not Available	Not Available	Not Available	Available	Available	Available	Not Available	Not Available	Not Available	Not Available
High Frequency	Luum	Available	Not Available	Not Available	Not Available	Not Available	Not Available	Not Available	Not Available	Available	Available	Available	Not Available	Not Available	Not Available	Not Available
Interstice	Luum	Available	Not Available	Not Available	Available	Available	Not Available	Not Available	Not Available	Available	Available	Available	Not Available	Not Available	Not Available	Not Available
Lariat (*) (**)	Maharam	Available	Not Available	Not Available	Not Available	Not Available	Available	Not Available	Not Available	Not Available	Not Available	Not Available	Not Available	Not Available	Not Available	Not Available
Mantle	Maharam	Available	Not Available	Not Available	Not Available	Not Available	Not Available	Not Available	Not Available	Available	Available	Available	Not Available	Not Available	Not Available	Not Available
Medium	Maharam	Available	Not Available	Not Available	Not Available	Not Available	Not Available	Not Available	Not Available	Available	Available	Available	Not Available	Not Available	Not Available	Not Available
Merit	Maharam	Available	Not Available	Not Available	Not Available	Not Available	Not Available	Not Available	Not Available	Available	Available	Available	Not Available	Not Available	Not Available	Not Available
Meta Texture (*) (**)	Luum	Not Available	Not Available	Not Available	Not Available	Not Available	Not Available	Not Available	Not Available	Not Available	Not Available	Not Available	Not Available	Not Available	Not Available	Not Available
Mode	Maharam	Available	Not Available	Not Available	Not Available	Not Available	Not Available	Not Available	Not Available	Available	Available	Available	Not Available	Not Available	Not Available	Not Available
Modulus (*)	Luum	Not Available	Not Available	Not Available	Not Available	Not Available	Available	Not Available	Not Available	Not Available	Not Available	Not Available	Not Available	Not Available	Not Available	Not Available
Velvet Underground	Luum	Not Available	Not Available	Not Available	Not Available	Not Available	Not Available	Not Available	Not Available	Not Available	Not Available	Available	Not Available	Not Available	Not Available	Not Available
Grade 5																
Adage	Luum	Available	Not Available	Not Available	Not Available	Available	Not Available	Not Available	Not Available	Not Available	Not Available	Not Available	Not Available	Not Available	Not Available	Not Available
Cult Classic	Luum	Not Available	Not Available	Not Available	Not Available	Not Available	Not Available	Not Available	Not Available	Available	Available	Available	Not Available	Not Available	Not Available	Not Available
Keen	Maharam	Available	Not Available	Not Available	Not Available	Not Available	Not Available	Not Available	Not Available	Available	Available	Available	Not Available	Not Available	Not Available	Not Available
Ledger (**)	Maharam	Available	Not Available	Not Available	Not Available	Not Available	Not Available	Not Available	Not Available	Not Available	Not Available	Not Available	Not Available	Not Available	Not Available	Not Available
Monotex (*) (**)	Luum	Not Available	Not Available	Not Available	Not Available	Not Available	Not Available	Not Available	Not Available	Not Available	Available	Available	Not Available	Not Available	Not Available	Not Available
Particulate	Luum	Available	Not Available	Not Available	Not Available	Not Available	Not Available	Not Available	Not Available	Available	Available	Available	Not Available	Not Available	Not Available	Not Available
Point Set (*)	Luum	Not Available	Not Available	Not Available	Not Available	Not Available	Not Available	Not Available	Not Available	Not Available	Not Available	Not Available	Not Available	Not Available	Not Available	Not Available
Refraction	Luum	Not Available	Not Available	Not Available	Available	Not Available	Not Available	Not Available	Not Available	Not Available	Not Available	Not Available	Not Available	Not Available	Not Available	Not Available
Sort (*) (**)	Maharam	Available	Not Available	Not Available	Not Available	Not Available	Available	Not Available	Not Available	Not Available	Not Available	Not Available	Not Available	Not Available	Not Available	Not Available
Stature (*) (**)	Maharam	Not Available	Available	Not Available	Not Available	Not Available	Not Available	Not Available	Available	Not Available	Not Available	Not Available	Not Available	Not Available	Not Available	Not Available
Subdivide	Luum	Not Available	Not Available	Not Available	Not Available	Not Available	Not Available	Not Available	Not Available	Not Available	Not Available	Available	Not Available	Not Available	Not Available	Not Available
Willow (*)	Maharam	Not Available	Not Available	Not Available	Not Available	Not Available	Not Available	Not Available	Available	Not Available	Not Available	Not Available	Not Available	Not Available	Not Available	Not Available

Note

* Bleach Cleanable ** Coated *** AM Antimicrobial

- studio tk reserves the right, based on fabric or leather selected, to add well-placed seams to units where size, fabric direction, and fabric elasticity interfere with the high quality standards studio tk strives to achieve.

textiles

The following chart outlines the fabrics that are available for use on studio tk seating and screens.

		<div style="display: flex; align-items: center;"> <div style="width: 15px; height: 10px; background-color: #cccccc; margin-right: 5px;"></div> Available <div style="width: 15px; height: 10px; background-color: #ffffff; margin-left: 10px; margin-right: 5px; border: 1px solid #000;"></div> Not Available </div>														
Fabric Vendor		aventura	beso	borough	borough pillows	cesto poufs	cesto tables	clip	clique	cover	dual	F500 series	fractals	havn	infinito	jima
Grade 6																
Amalgam	Luum															
Basel	Kvadrat															
Bluff (*) (**)	Maharam															
Buffer (*)	Maharam															
Duo Chrome (*)	Luum															
Gust (*)	Maharam															
Haptic	Luum															
Instill (*) (**)	Maharam															
Knurl	Luum															
Levity (*)	Maharam															
Outpress (*)	Luum															
Perilune (*)	Luum															
Photogram	Luum															
Scuba (*) (**)	Maharam															
Soft Static	Luum															
Vector (*)	Luum															
Grade 7																
Canvas 2	Kvadrat															
Clara 2	Kvadrat															
Compound (**)	Maharam															
Contrast Slub <small>EXTENDED LEAD TIME</small>	Luum															
Ephemera (*)	Luum															
Everyday Boucle	Luum															
Flex Wool	Luum															
Macrotweed	Luum															
Oeuvre	Luum															
Pebble Melange	Luum															
Point-to-Point	Luum															
Remix 3	Kvadrat															
Structured Stripe (*)	Luum															
Strum (*) (**)	Maharam															
Tilt Shift Redux	Luum															
Tonica 2	Kvadrat															
Wool Fleck	Luum															

Note

* Bleach Cleanable ** Coated *** AM Antimicrobial

- studio tk reserves the right, based on fabric or leather selected, to add well-placed seams to units where size, fabric direction, and fabric elasticity interfere with the high quality standards studio tk strives to achieve.

textiles (continued)

The following chart outlines the fabrics that are available for use on studio tk seating and screens.

	Fabric Vendor	kalm	kuskoa	kuskoa bi	lasai	libelle	lite wall	nina	pala	petal	pico	pillow accessories	qui	santé	trine	vettore
Grade 6																
Amalgam	Luum															
Basel	Kvadrat															
Bluff (*) (**)	Maharam															
Buffer (*)	Maharam															
Duo Chrome (*)	Luum															
Gust (*)	Maharam															
Haptic	Luum															
Instill (*) (**)	Maharam															
Knurl	Luum															
Levity (*)	Maharam															
Outpress (*)	Luum															
Perilune (*)	Luum															
Photogram	Luum															
Scuba (*) (**)	Maharam															
Soft Static	Luum															
Vector (*)	Luum															
Grade 7																
Canvas 2	Kvadrat															
Clara 2	Kvadrat															
Compound (**)	Maharam															
Contrast Slub <small>EXTENDED LEAD TIME</small>	Luum															
Ephemera (*)	Luum															
Everyday Boucle	Luum															
Flex Wool	Luum															
Macrotweed	Luum															
Oeuvre	Luum															
Pebble Melange	Luum															
Point-to-Point	Luum															
Remix 3	Kvadrat															
Structured Stripe (*)	Luum															
Strum (*) (**)	Maharam															
Tilt Shift Redux	Luum															
Tonica 2	Kvadrat															
Wool Fleck	Luum															

Note

* Bleach Cleanable ** Coated *** AM Antimicrobial

- studio tk reserves the right, based on fabric or leather selected, to add well-placed seams to units where size, fabric direction, and fabric elasticity interfere with the high quality standards studio tk strives to achieve.

textiles

The following chart outlines the fabrics that are available for use on studio tk seating and screens.

		<div style="display: flex; align-items: center;"> <div style="width: 15px; height: 10px; background-color: #cccccc; margin-right: 5px;"></div> Available <div style="width: 15px; height: 10px; border: 1px solid black; margin-right: 5px; margin-left: 10px;"></div> Not Available </div>														
Fabric Vendor		aventura	beso	borough	borough pillows	cesto poufs	cesto tables	clip	clique	cover	dual	F500 series	fractals	havn	infinito	jima
Grade 8																
Barberpole Basket	Luum															
Construct	Luum															
Cosset	Maharam															
Full Wool	Luum															
Geoglyph	Luum															
Homage	Luum															
Line Language	Luum															
Molly 2	Kvadrat															
Prime (*)	Maharam															
Recheck	Kvadrat															
Re-Wool	Kvadrat															
Thangka (*)	Luum															
Wavefield	Luum															
Welded	Luum															
Grade 9																
Apt (*) (**)	Maharam															
Divina 3	Kvadrat															
Divina MD	Kvadrat															
Divina Melange 3	Kvadrat															
Equilux	Luum															
Graph Speck	Luum															
Heather Felt	Luum															
Melange Check	Luum															
Melange Nap	Kvadrat															
Savanna	Kvadrat															
Steelcut 2	Kvadrat															
Steelcut Trio 3	Kvadrat															
Super Shearling	Luum															
Top Coat (*) (**) (***)	Luum															
Twill Weave	Kvadrat															

Note

* Bleach Cleanable ** Coated *** AM Antimicrobial

- studio tk reserves the right, based on fabric or leather selected, to add well-placed seams to units where size, fabric direction, and fabric elasticity interfere with the high quality standards studio tk strives to achieve.

textiles (continued)

The following chart outlines the fabrics that are available for use on studio tk seating and screens.

	Fabric Vendor	kalm	kuskoa	kuskoa bi	lasai	libelle	lite wall	nina	pala	petal	pico	pillow accessories	qui	santé	trine	vettore
Grade 8																
Barberpole Basket	Luum															
Construct	Luum															
Cosset	Maharam															
Full Wool	Luum															
Geoglyph	Luum															
Homage	Luum															
Line Language	Luum															
Molly 2	Kvadrat															
Prime (*)	Maharam															
Recheck	Kvadrat															
Re-Wool	Kvadrat															
Thangka (*)	Luum															
Wavefield	Luum															
Welded	Luum															
Grade 9																
Apt (*) (**)	Maharam															
Divina 3	Kvadrat															
Divina MD	Kvadrat															
Divina Melange 3	Kvadrat															
Equilux	Luum															
Graph Speck	Luum															
Heather Felt	Luum															
Melange Check	Luum															
Melange Nap	Kvadrat															
Savanna	Kvadrat															
Steelcut 2	Kvadrat															
Steelcut Trio 3	Kvadrat															
Super Shearling	Luum															
Top Coat (*) (**) (***)	Luum															
Twill Weave	Kvadrat															

Note

* Bleach Cleanable ** Coated *** AM Antimicrobial

- studio tk reserves the right, based on fabric or leather selected, to add well-placed seams to units where size, fabric direction, and fabric elasticity interfere with the high quality standards studio tk strives to achieve.

textiles

The following chart outlines the fabrics that are available for use on studio tk seating and screens.

	Fabric Vendor	aventura	beso	borough	borough pillows	cesto poufs	cesto tables	clip	clique	cover	dual	F500 series	fractals	havn	infinito	jima
Grade 10																
Anagram	Maharam	Available	Not Available	Available	Available	Available	Available	Available	Available	Available	Available	Available	Available	Available	Available	Available
Angulo	Luum	Available	Available	Available	Available	Available	Available	Available	Available	Available	Available	Available	Available	Available	Available	Available
Colline 2	Kvadrat	Available	Available	Available	Available	Available	Available	Available	Available	Available	Available	Available	Available	Available	Available	Available
Color Fuse (**)	Luum	Available	Available	Available	Available	Available	Available	Available	Available	Available	Available	Available	Available	Available	Available	Available
Fiord 2	Kvadrat	Available	Available	Available	Available	Available	Available	Available	Available	Available	Available	Available	Available	Available	Available	Available
Fleece	Luum	Available	Available	Available	Available	Available	Available	Available	Available	Available	Available	Available	Available	Available	Available	Available
Hallingdal 65	Kvadrat	Available	Available	Available	Available	Available	Available	Available	Available	Available	Available	Available	Available	Available	Available	Available
Megapixel	Luum	Available	Available	Available	Available	Available	Available	Available	Available	Available	Available	Available	Available	Available	Available	Available
Scape	Maharam	Available	Available	Available	Available	Available	Available	Available	Available	Available	Available	Available	Available	Available	Available	Available
Tonus 4	Kvadrat	Available	Available	Available	Available	Available	Available	Available	Available	Available	Available	Available	Available	Available	Available	Available
Grade 11																
Rubric	Luum	Available	Available	Available	Available	Available	Available	Available	Available	Available	Available	Available	Available	Available	Available	Available
Sunniva 2	Kvadrat	Available	Available	Available	Available	Available	Available	Available	Available	Available	Available	Available	Available	Available	Available	Available
Grade 12																
Hearth	Maharam	Available	Available	Available	Available	Available	Available	Available	Available	Available	Available	Available	Available	Available	Available	Available
Grade 13																
Coda 2	Kvadrat	Available	Available	Available	Available	Available	Available	Available	Available	Available	Available	Available	Available	Available	Available	Available
Emergent	Luum	Available	Available	Available	Available	Available	Available	Available	Available	Available	Available	Available	Available	Available	Available	Available
Reef	Maharam	Available	Available	Available	Available	Available	Available	Available	Available	Available	Available	Available	Available	Available	Available	Available
Uniform Melange	Kvadrat	Available	Available	Available	Available	Available	Available	Available	Available	Available	Available	Available	Available	Available	Available	Available
Grade 14																
Arc Angle	Luum	Available	Available	Available	Available	Available	Available	Available	Available	Available	Available	Available	Available	Available	Available	Available
Scale Factor	Luum	Available	Available	Available	Available	Available	Available	Available	Available	Available	Available	Available	Available	Available	Available	Available
Vidar 3	Kvadrat	Available	Available	Available	Available	Available	Available	Available	Available	Available	Available	Available	Available	Available	Available	Available
Grade 15																
Waterborn	Kvadrat	Available	Available	Available	Available	Available	Available	Available	Available	Available	Available	Available	Available	Available	Available	Available
Grade 16																
Mitered	Luum	Available	Available	Available	Available	Available	Available	Available	Available	Available	Available	Available	Available	Available	Available	Available
Navigate	Luum	Available	Available	Available	Available	Available	Available	Available	Available	Available	Available	Available	Available	Available	Available	Available
Second Nature	Luum	Available	Available	Available	Available	Available	Available	Available	Available	Available	Available	Available	Available	Available	Available	Available
Leather																
LB - Merus	Luum	Available	Available	Available	Available	Available	Available	Available	Available	Available	Available	Available	Available	Available	Available	Available
LC - Pela	Luum	Available	Available	Available	Available	Available	Available	Available	Available	Available	Available	Available	Available	Available	Available	Available
LD - Fortis	Luum	Available	Available	Available	Available	Available	Available	Available	Available	Available	Available	Available	Available	Available	Available	Available

Note

* Bleach Cleanable ** Coated *** AM Antimicrobial

- studio tk reserves the right, based on fabric or leather selected, to add well-placed seams to units where size, fabric direction, and fabric elasticity interfere with the high quality standards studio tk strives to achieve.

textiles (continued)

The following chart outlines the fabrics that are available for use on studio tk seating and screens.

		Available	Available	Available	Available	Available	Available	Available	Available	Available	Available	Available	Available	Available	Available	Available	Available	Available
	Fabric Vendor	kalm	kuskoa	kuskoa bi	lasai	libelle	lite wall	nina	pala	petal	pico	pillow accessories	qui	santé	trine	vettore		
Grade 10																		
Anagram	Maharam																	
Angulo	Luum																	
Colline 2	Kvadrat																	
Color Fuse (**)	Luum																	
Fiord 2	Kvadrat																	
Fleece	Luum																	
Hallingdal 65	Kvadrat																	
Megapixel	Luum																	
Scape	Maharam																	
Tonus 4	Kvadrat																	
Grade 11																		
Rubric	Luum																	
Sunniva 2	Kvadrat																	
Grade 12																		
Hearth	Maharam																	
Grade 13																		
Coda 2	Kvadrat																	
Emergent	Luum																	
Reef	Maharam																	
Uniform Melange	Kvadrat																	
Grade 14																		
Arc Angle	Luum																	
Scale Factor	Luum																	
Vidar 3	Kvadrat																	
Grade 15																		
Waterborn	Kvadrat																	
Grade 16																		
Mitered	Luum																	
Navigate	Luum																	
Second Nature	Luum																	
Leather																		
LB - Merus	Luum																	
LC - Pela	Luum																	
LD - Fortis	Luum																	

Note

* Bleach Cleanable ** Coated *** AM Antimicrobial

- studio tk reserves the right, based on fabric or leather selected, to add well-placed seams to units where size, fabric direction, and fabric elasticity interfere with the high quality standards studio tk strives to achieve.

frame finish

The following chart outlines the finishes that are available for use on studio tk.

	SEATING																									
	aventura	africa	beso	borough lounge	clip	clique	cover	delta	F500 series	fractals	havn	jima	kalm	kes	kuskoa	kuskoa bi	lasai	libelle	nina	petal	pico	qui	santé	trine	vettore	
Solid Wood																										
Basque White Oak	BU																									
Sierra	DV																									
Cocoa Brown	DY																									
Truffle	DZ																									
Natural Oak	NK																									
Metal																										
Chrome	C6																									
Polished Aluminum	C9																									
Stainless Steel	S1																									
Fashion Paint																										
Honey	D2																									
Madder	D3																									
Black Cherry	D4																									
Autumn	D5																									
Ocean	D6																									
Seafoam	D7																									
Hunter	D8																									
Chili	D9																									
Fundamental Paint																										
Gilded Ash	73																									
Platinum	60																									
Soft Gris	26																									
Sand	27																									
Earth	28																									
Very White	83																									
Granite	51																									
Ebony	52																									
Plastic																										
Sand	JU																									
Clay	JZ																									
Vondom Plastic																										
White	C1																									
Ecru	C2																									
Black	C3																									

frame finish (continued)

The following chart outlines the finishes that are available for use on studio tk.

		TABLES							
		lite wall	bevy	cesto tables	artifort compass	freehand	havn	mari-sol	rec
Solid Wood									
Basque White Oak	BU				■		■		
Sierra	DV						■		
Cocoa Brown	DY						■		
Truffle	DZ				■				
Natural Oak	NK						■		
Metal									
Chrome	C6	■							
Polished Aluminum	C9		■						
Stainless Steel	S1								
Fashion Paint									
Honey	D2		■			■		■	■
Madder	D3		■						
Black Cherry	D4		■					■	■
Autumn	D5		■					■	■
Ocean	D6		■					■	■
Seafoam	D7		■					■	■
Hunter	D8		■					■	■
Chili	D9		■					■	■
Fundamental Paint									
Gilded Ash	73		■			■		■	■
Platinum	60		■					■	■
Soft Gris	26		■					■	■
Sand	27		■					■	■
Earth	28		■					■	■
Very White	83		■					■	■
Granite	51		■					■	■
Ebony	52		■					■	■
Plastic									
Sand	JU								
Clay	JZ								
Vondom Plastic									
White	C1								
Ecru	C2								
Black	C3								

surface finishes

The following chart outlines the surface finishes that are available for use on studio tk products.

		TABLES									
		bevy	cesto tables	fractals	freehand	havn	libelle tablet	mari-sol	rec	santé	sly
Studio Veneer											
Basque White Oak	BU	■	■	■	■	■	■	■	■	■	■
Sierra	DV	■	■	■	■	■	■	■	■	■	■
Cocoa Brown	DY	■	■	■	■	■	■	■	■	■	■
Truffle	DZ	■	■	■	■	■	■	■	■	■	■
Natural Oak	NK	■	■	■	■	■	■	■	■	■	■
Vondom Solid Core											
Ebony	RX	■	■	■	■	■	■	■	■	■	■
White	RY	■	■	■	■	■	■	■	■	■	■
Solid Surface											
Glacier White	MV	■	■	■	■	■	■	■	■	■	■
Back-Painted Glass											
White	K6	■	■	■	■	■	■	■	■	■	■
Granite	E3	■	■	■	■	■	■	■	■	■	■
Ebony	E4	■	■	■	■	■	■	■	■	■	■
Soft Gris	BM	■	■	■	■	■	■	■	■	■	■
Platinum	BN	■	■	■	■	■	■	■	■	■	■
Sand	B2	■	■	■	■	■	■	■	■	■	■
Earth	B3	■	■	■	■	■	■	■	■	■	■
Gilded Ash	BZ	■	■	■	■	■	■	■	■	■	■
Honey	AD	■	■	■	■	■	■	■	■	■	■
Madder	AE	■	■	■	■	■	■	■	■	■	■
Black Cherry	AP	■	■	■	■	■	■	■	■	■	■
Autumn	AQ	■	■	■	■	■	■	■	■	■	■
Ocean	AR	■	■	■	■	■	■	■	■	■	■
Seafoam	AU	■	■	■	■	■	■	■	■	■	■
Hunter	AV	■	■	■	■	■	■	■	■	■	■
Chili	AA	■	■	■	■	■	■	■	■	■	■

surface finishes

The following chart outlines the surface finishes that are available for use on studio tk products.

		TABLES							
		bevy	cesto tables	fractals	freehand	havn	libelle tablet	mari-sol	rec
Studio Foundation Laminate									
Very White	RV								
Storm White	LW								
Crisp Grey	2T								
Earth	2V								
Sand	2U								
Ebony	CV								
Surface Leather									
Very White	L159								
Platinum	L160								
Granite	L161								
Ebony	L162								
Beige	L163								
Chocolate	L164								
Saddle Leather									
Tanned	UD								
Havana	UE								
Felt									
Smoke	LF								
Charcoal	LH								
Linoleum									
Iron	FE								
Pebble	FF								
Burgundy	FG								
Smokey Blue	FJ								
Pistachio	FH								

thread finishes

The following chart outlines the surface finishes that are available for use on studio tk products.

		qui
<input checked="" type="checkbox"/>	Available	
<input type="checkbox"/>	Not Available	
Thread Finishes		
White	TC01	<input checked="" type="checkbox"/>
Silver	TC02	<input checked="" type="checkbox"/>
Black	TC03	<input checked="" type="checkbox"/>
Navy	TC04	<input checked="" type="checkbox"/>
Golden Brown	TC06	<input checked="" type="checkbox"/>
Forsythia	TC07	<input checked="" type="checkbox"/>
Scarlet	TC08	<input checked="" type="checkbox"/>
Sunset	TC09	<input checked="" type="checkbox"/>
Plumb	TC10	<input checked="" type="checkbox"/>

power finishes

The following chart outlines the surface finishes that are available for use on studio tk products.

<input checked="" type="checkbox"/> Available <input type="checkbox"/> Not Available	SEATING	TABLES		
	fractals	bevy	clique	rec
Plastic				
Storm White (Coordinate Volume) 7Y	<input type="checkbox"/>	<input checked="" type="checkbox"/>	<input type="checkbox"/>	<input checked="" type="checkbox"/>
Ebony (Coordinate Volume) 8B	<input type="checkbox"/>	<input checked="" type="checkbox"/>	<input type="checkbox"/>	<input checked="" type="checkbox"/>
Metal				
Storm White (Coordinate Metal Foundation) 74	<input type="checkbox"/>	<input checked="" type="checkbox"/>	<input type="checkbox"/>	<input checked="" type="checkbox"/>
Ebony (Coordinate Metal Foundation) 52	<input checked="" type="checkbox"/>	<input checked="" type="checkbox"/>	<input checked="" type="checkbox"/>	<input checked="" type="checkbox"/>

knit mesh

The following chart outlines the surface finishes that are available for use on studio tk products.

		cesto poufs	dual	cesto tables	libelle
<input checked="" type="checkbox"/> Available <input type="checkbox"/> Not Available					
Knit Mesh Finish					
Eggshell	K413	<input checked="" type="checkbox"/>	<input checked="" type="checkbox"/>	<input checked="" type="checkbox"/>	<input checked="" type="checkbox"/>
Stone	K414	<input checked="" type="checkbox"/>	<input checked="" type="checkbox"/>	<input checked="" type="checkbox"/>	<input checked="" type="checkbox"/>
Khaki	K415	<input checked="" type="checkbox"/>	<input checked="" type="checkbox"/>	<input checked="" type="checkbox"/>	<input checked="" type="checkbox"/>
Silver	K416	<input checked="" type="checkbox"/>	<input checked="" type="checkbox"/>	<input checked="" type="checkbox"/>	<input checked="" type="checkbox"/>
Taupe	K417	<input checked="" type="checkbox"/>	<input checked="" type="checkbox"/>	<input checked="" type="checkbox"/>	<input checked="" type="checkbox"/>
Graphite	K418	<input checked="" type="checkbox"/>	<input checked="" type="checkbox"/>	<input checked="" type="checkbox"/>	<input checked="" type="checkbox"/>
Goldenrod	K419	<input checked="" type="checkbox"/>	<input checked="" type="checkbox"/>	<input checked="" type="checkbox"/>	<input checked="" type="checkbox"/>
Sunset	K420	<input checked="" type="checkbox"/>	<input checked="" type="checkbox"/>	<input checked="" type="checkbox"/>	<input checked="" type="checkbox"/>
Cardinal	K421	<input checked="" type="checkbox"/>	<input checked="" type="checkbox"/>	<input checked="" type="checkbox"/>	<input checked="" type="checkbox"/>
Magenta	K422	<input checked="" type="checkbox"/>	<input checked="" type="checkbox"/>	<input checked="" type="checkbox"/>	<input checked="" type="checkbox"/>
Cobalt	K423	<input checked="" type="checkbox"/>	<input checked="" type="checkbox"/>	<input checked="" type="checkbox"/>	<input checked="" type="checkbox"/>

clip finish

The following chart outlines the surface finishes that are available for use on studio tk products.

<input checked="" type="checkbox"/> Available <input type="checkbox"/> Not Available		clip
Metal Finish		
Polished Aluminum	C9	<input checked="" type="checkbox"/>
Very White	83	<input checked="" type="checkbox"/>
Granite	51	<input checked="" type="checkbox"/>
Ebony	52	<input checked="" type="checkbox"/>
Honey	D2	<input checked="" type="checkbox"/>
Madder	D3	<input checked="" type="checkbox"/>
Black Cherry	D4	<input checked="" type="checkbox"/>
Autumn	D5	<input checked="" type="checkbox"/>
Ocean	D6	<input checked="" type="checkbox"/>
Seafoam	D7	<input checked="" type="checkbox"/>
Hunter	D8	<input checked="" type="checkbox"/>
Chili	D9	<input checked="" type="checkbox"/>
Gilded Ash	73	<input checked="" type="checkbox"/>
Platinum	60	<input checked="" type="checkbox"/>
Soft Gris	26	<input checked="" type="checkbox"/>
Sand	27	<input checked="" type="checkbox"/>
Earth	28	<input checked="" type="checkbox"/>



contents

Seating	449
AC Executive	459
Finishes & Textiles	475



seating

AC Lounge	4 5 0
Jean	4 5 2
Metropolitan 14	4 5 4
Posa	4 5 6

ac lounge

AC Lounge is elegant and timeless, featuring stitched cushions on the seat and backrests. The offering includes two and three-seater sofas, and a lounge chair.

Designer: Antonio Citterio

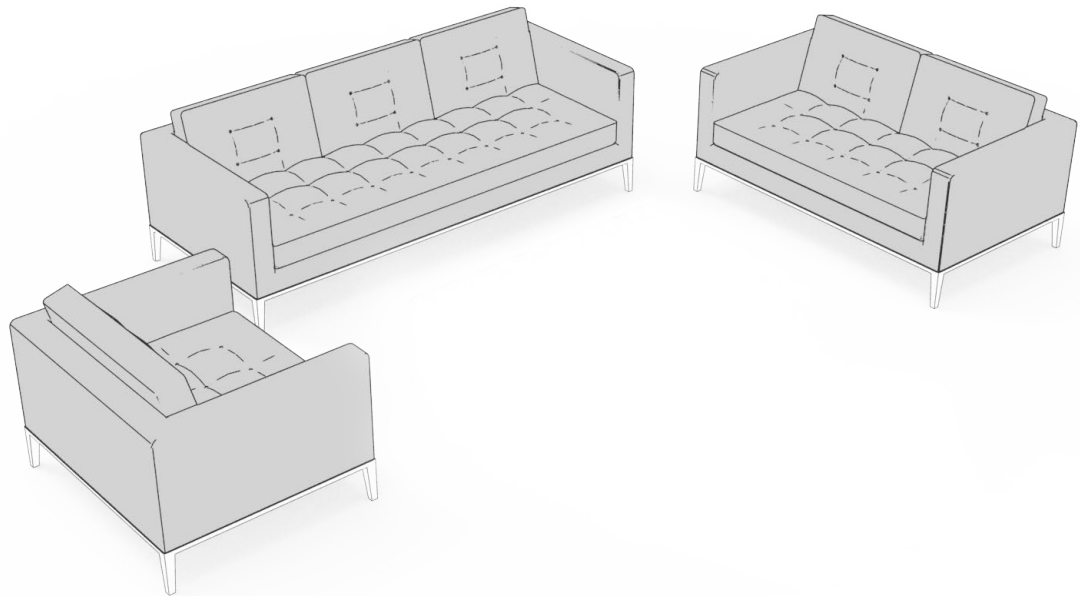

dimensions

- Designed and tested for users up to 110kg/242 lbs
- Meets standard European NEN-16139 requirements

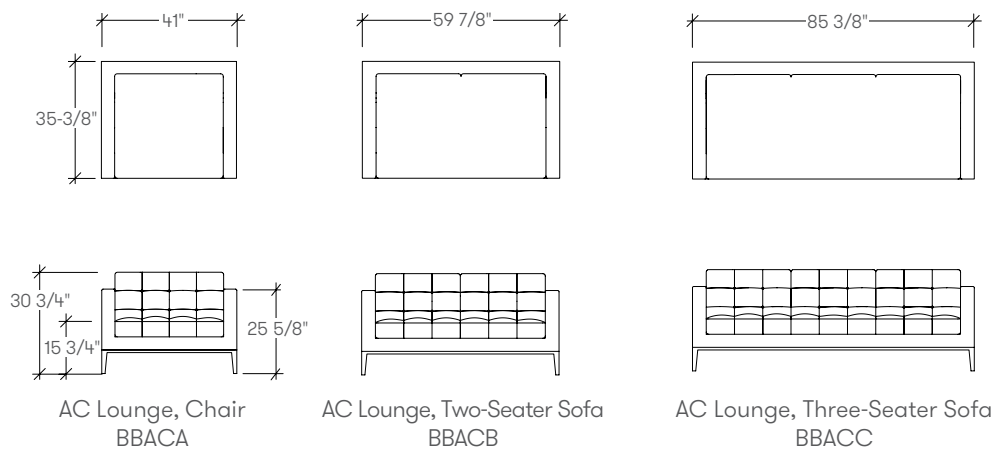

weights

AC Lounge Lounge Chair	135 - 140 lbs
AC Lounge Lounge Chair (2)	270 - 280 lbs
AC Lounge Lounge Chair, Two-Seater Sofa	175 - 180 lbs
AC Lounge Lounge Chair, Three-Seater Sofa	240 - 245 lbs

COM/COL material requirement

Yardage is based on a non-patterned fabric. Additional yardage may be required for pattern repeats and the matching required. Leather yield may be affected by the quality of the COL. However, variance in the size of the hides will not affect the yield.



CHAIR, TWO-SEATER SOFA, THREE-SEATER SOFA AND OTTOMAN	COM [yards]	COL [sq. ft]
A Chair	6	108
B Two-Seater Sofa	8	144
C Three-Seater Sofa	11 1/2	206

BBAC ac lounge lounge chair

Product Options

Style	Upholstery Finish	Frame Finish
A Chair	Fabric	F8 Bronzed Nickel
B Two-Seater Sofa (59 7/8" / 152cm)		
C Three-Seater Sofa (85 3/8" / 217cm)		

Price

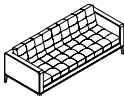
	COM	COL	Gr.1	Gr.2	Gr.3	Gr.4	Gr.5	Gr.6	Gr.7	Gr.8	Gr.9	Gr.10	Gr.11	Leather		
														LB	LC	LD
 A Chair	6148	6763	6426	6551	6658	6783	6875	6952	7030	7122	7215	7308	7416			
 B Two-Seater Sofa	8090	8898	8461	8626	8771	8935	9060	9162	9265	9389	9513	9636	9781			
 C Three-Seater Sofa	10013	11014	10547	10783	10991	11229	11406	11555	11703	11881	12058	12237	12444			
	Gr.12	Gr.13	Gr.14	Gr.15	Gr.16	Gr.17	Gr.18	Gr.19	Gr.20							
A Chair	7540	7694	7850	8004	8158	8314	8468	8622	8778					8433	9268	9547
B Two-Seater Sofa	9946	10152	10359	10564	10771	10977	11184	11389	11595					11126	12239	12610
C Three-Seater Sofa	12681	12978	13274	13571	13867	14164	14459	14756	15052					14216	15817	16350

jean

Jean has been designed with comfort in mind, offering a high sitting position combined with a strong yet minimal design. This lounge chair works well in offices, hospitality and public spaces as well as residential interiors.

Designer: Antonio Citterio

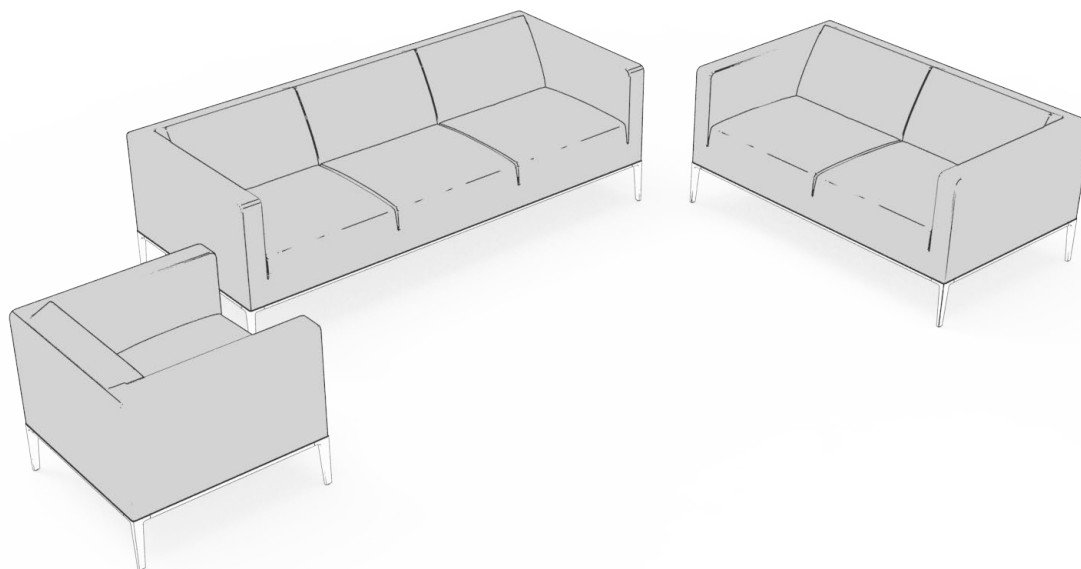

dimensions

- Designed and tested for users up to 110kg/242 lbs
- Meets standard European NEN-16139 requirements

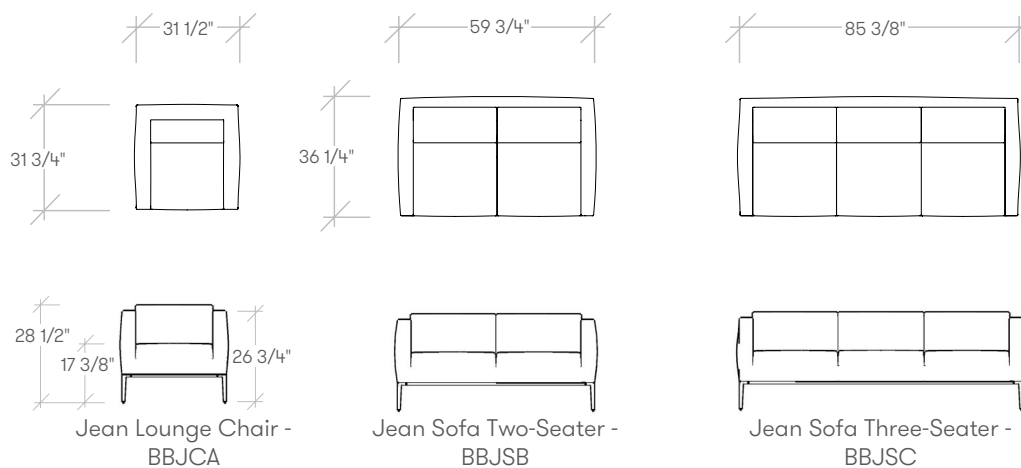

metropolitan 14

Metropolitan 14 is the reinterpretation of the classic Metropolitan chair. The volume of the chair has become thinner and the surfaces have enhanced their flowing design with a fully integrated seat cushion. The chair design is an invitation to sit down and enjoy a moment's rest while still interacting with the environment from a comfortable position.

Designer: Jeffrey Bennett

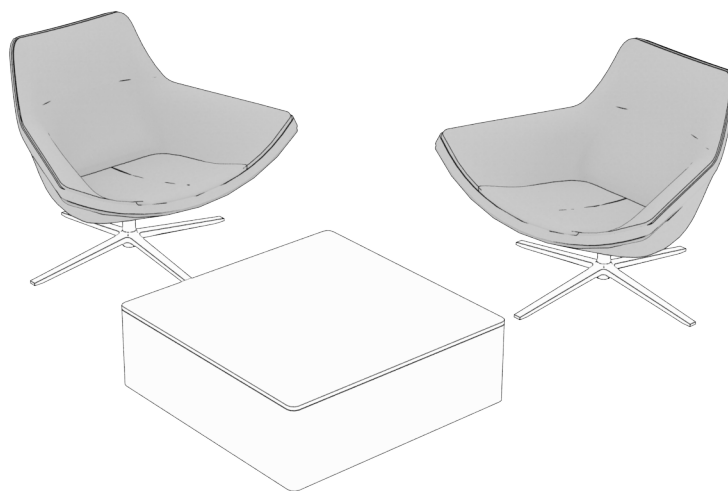

dimensions

- Designed and tested for users up to 110kg/242 lbs
- Meets standard European NEN-16139 requirements



Lounge Chair
BBMCA

weights

Metropolitan 1+ Lounge	50 - 55 lbs
------------------------	-------------

COM/COL material requirement

Yardage is based on a non-patterned fabric. Additional yardage may be required for pattern repeats and the matching required. Leather yield may be affected by the quality of the COL. However, variance in the size of the hides will not affect the yield.

METROPOLITAN LOUNGE CHAIR		COM	COL
		[yards]	[sq. ft]
A Lounge Chair		4	72

BBMC metropolitan 1+ lounge

Product Options

Style	Upholstery Finish	Frame Finish
A Lounge Chair	Fabric Leather	C6 Chrome

Note Swivel is not auto-return to center



	Price												
	COM	COL	Gr.1	Gr.2	Gr.3	Gr.4	Gr.5	Gr.6	Gr.7	Gr.8	Gr.9	Gr.10	Gr.11
A Lounge Chair	4860	5346	5046	5128	5200	5283	5345	5396	5449	5510	5571	5634	5706
											Leather		
A Lounge Chair	Gr.12	Gr.13	Gr.14	Gr.15	Gr.16	Gr.17	Gr.18	Gr.19	Gr.20		LB	LC	LD
	5788	5892	5995	6098	6201	6303	6407	6510	6613		6460	7017	7202

posa

Posa Chairs convey a sense of refined luxury while meeting rigorous usage requirements in public spaces. The profile and clean design offers a comfortable seating experience for a variety of spaces.

Designer: David Chipperfield

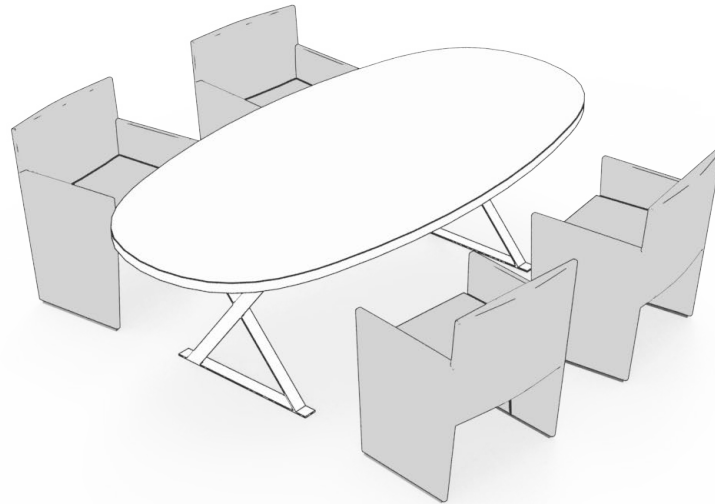

dimensions

- Designed and tested for users up to 110kg/242 lbs
- Meets standard European NEN-16139 requirements

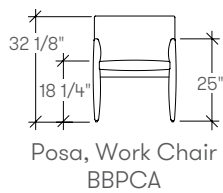
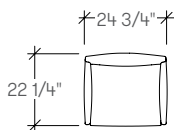

weights

Posa Chair	37 - 42 lbs
------------	-------------

COM/COL material requirement

Yardage is based on a non-patterned fabric. Additional yardage may be required for pattern repeats and the matching required. Leather yield may be affected by the quality of the COL. However, variance in the size of the hides will not affect the yield.

WORK CHAIR	COM [yards]	COL [sq. ft]
A Work Chair	3 1/4	58

BBPC **posa chair**

Product Options

Style	Upholstery Finish	Caster Option	Frame Finish
A Work Chair	Fabric	Y Yes	C9 Polished Aluminum



	Price															
	COM	COL	Gr.1	Gr.2	Gr.3	Gr.4	Gr.5	Gr.6	Gr.7	Gr.8	Gr.9	Gr.10	Gr.11			
A Work Chair	4224	4646	4374	4442	4500	4567	4617	4660	4701	4751	4801	4852	4910			
														Leather		
A Work Chair	Gr.12	Gr.13	Gr.14	Gr.15	Gr.16	Gr.17	Gr.18	Gr.19	Gr.20		LB	LC	LD			
	4978	5061	5145	5229	5313	5396	5480	5565	5648		5551	6003	6154			



ac executive

Designed by Antonio Citterio, AC Executive provides a distinctive range of wood-based furniture designed for executive offices, meeting rooms and home office.

Select from a complete series of Storage Walls, Bookcases, Credenzas, Desks and Tables to create a beautiful and functional workspace. Hand-selected horizontal grain veneers are finished with a matte sheen and complemented with polished chrome legs and accent detailing. Product features include: concealed soft-close hardware, veneer-matched drawer boxes, back-painted magnetic glass, LED lighting, wire access/management and acrylic floating dividers.

AC Veneer Group includes these finishes only: (P7) Grey Oak, (P8) Light Brushed Oak and (P9) Smoked Oak.

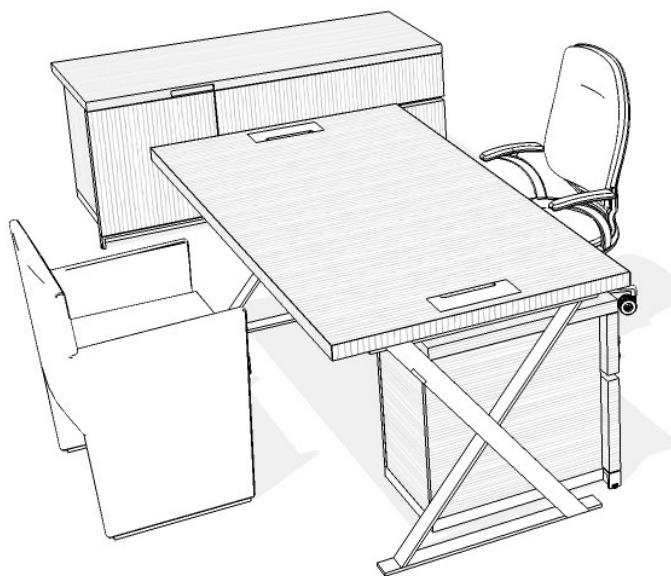

tables

Tables are available with wood gables or with X-Legs. These tables are intended for private offices or small meeting rooms.

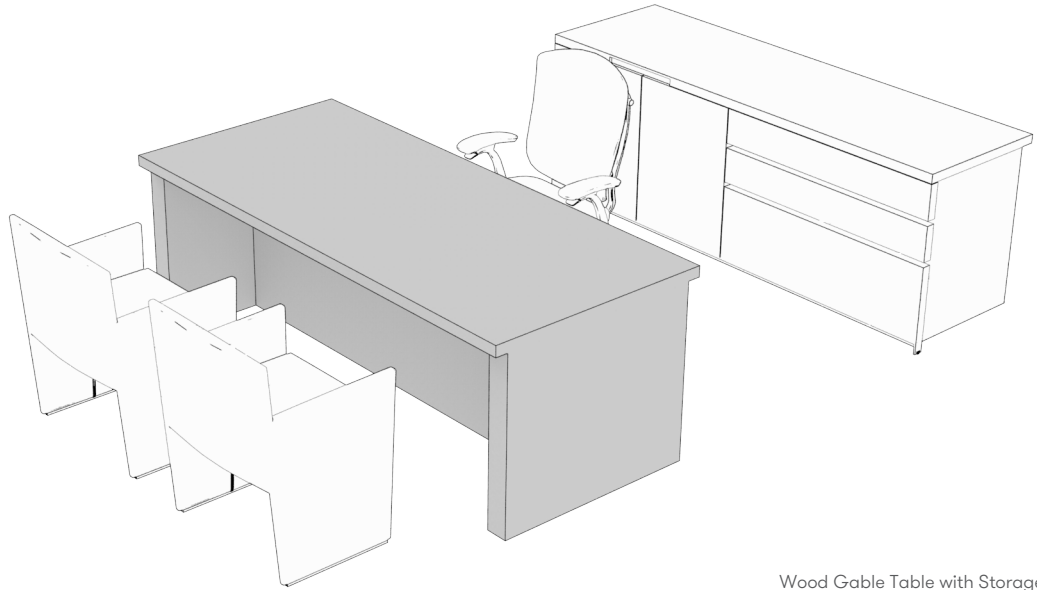

Wood Gable Table with Storage Wall shown

dimensions

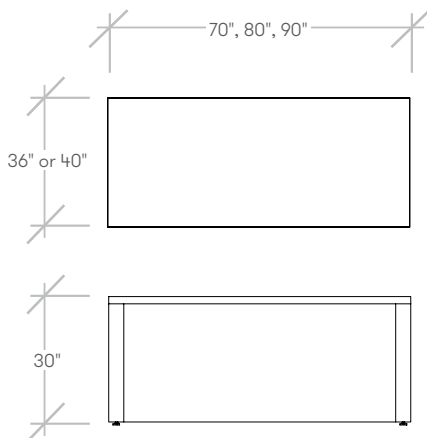

Wood Gable Table - ZXWT

- Is a table desk with no pedestals and options for no modesty, a half modesty or full modesty
- When no modesty is selected the desk will have Polished Chrome decorative rod between the gables
- End Gable is 3 1/2" wide and recessed 1 1/2" from each side of the worksurface
- Zero or two grommet can be specified
- When no modesty is specified, a Chrome cross beam will be between the legs

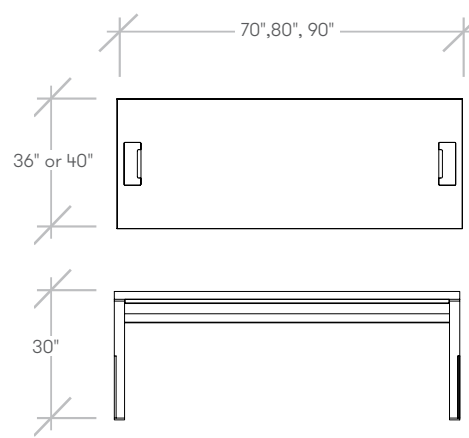

X-Leg Table - ZXXT

- Is a table desk with X-Legs and no pedestals
- Zero or two cut outs can be specified

ZXWT ac executive wood gable table

Product Options

Depth	Width	Height	Modesty	Grommet	Veneer Finish
36", 40"	70", 80", 90"	30"	N None H Half F Full	0 None 2 Two	AC Veneer Group CWS Custom Wood Stain

Note AC Veneer Group includes these finishes only: (P7) Grey Oak, (P8) Light Brushed Oak and (P9) Smoked Oak

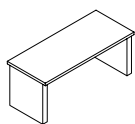

N 36"d x 70"w x 30"h, No Modesty

Price

No Grommet Two Grommets

7168 7838

N 36"d x 80"w x 30"h, No Modesty

7383 8054

N 36"d x 90"w x 30"h, No Modesty

7675 8345

N 40"d x 70"w x 30"h, No Modesty

7614 8284

N 40"d x 80"w x 30"h, No Modesty

7829 8499

N 40"d x 90"w x 30"h, No Modesty

8120 8790

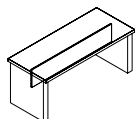

H 36"d x 70"w x 30"h, Half Modesty

7503 8173

H 36"d x 80"w x 30"h, Half Modesty

7719 8388

H 36"d x 90"w x 30"h, Half Modesty

8010 8679

H 40"d x 70"w x 30"h, Half Modesty

7948 8619

H 40"d x 80"w x 30"h, Half Modesty

8164 8835

H 40"d x 90"w x 30"h, Half Modesty

8455 9126

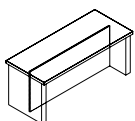

F 36"d x 70"w x 30"h, Full Modesty

7838 8507

F 36"d x 80"w x 30"h, Full Modesty

8054 8723

F 36"d x 90"w x 30"h, Full Modesty

8345 9014

F 40"d x 70"w x 30"h, Full Modesty

8284 8954

F 40"d x 80"w x 30"h, Full Modesty

8499 9169

F 40"d x 90"w x 30"h, Full Modesty

8790 9460

ZXXT ac executive x-leg table

Product Options

Depth	Width	Height	Grommet	Veneer Finish
36", 40"	70", 80", 90"	30"	0 None 2 Two	AC Veneer Group CWS Custom Wood Stain

Note AC Veneer Group includes these finishes only: (P7) Grey Oak, (P8) Light Brushed Oak and (P9) Smoked Oak

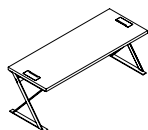

36"d x 70"w x 30"h

Price

No Grommet Two Grommets

11227 11857

36"d x 80"w x 30"h

11479 12108

36"d x 90"w x 30"h

11850 12481

40"d x 70"w x 30"h

11647 12276

40"d x 80"w x 30"h

11899 12529

40"d x 90"w x 30"h

12271 12901

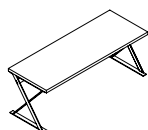

conference tables

X-Legs conference tables are intended for large boardroom applications. The tables have X-Legs and wire management shrouds below. Wood power access grommets are available in one, two or all sections.

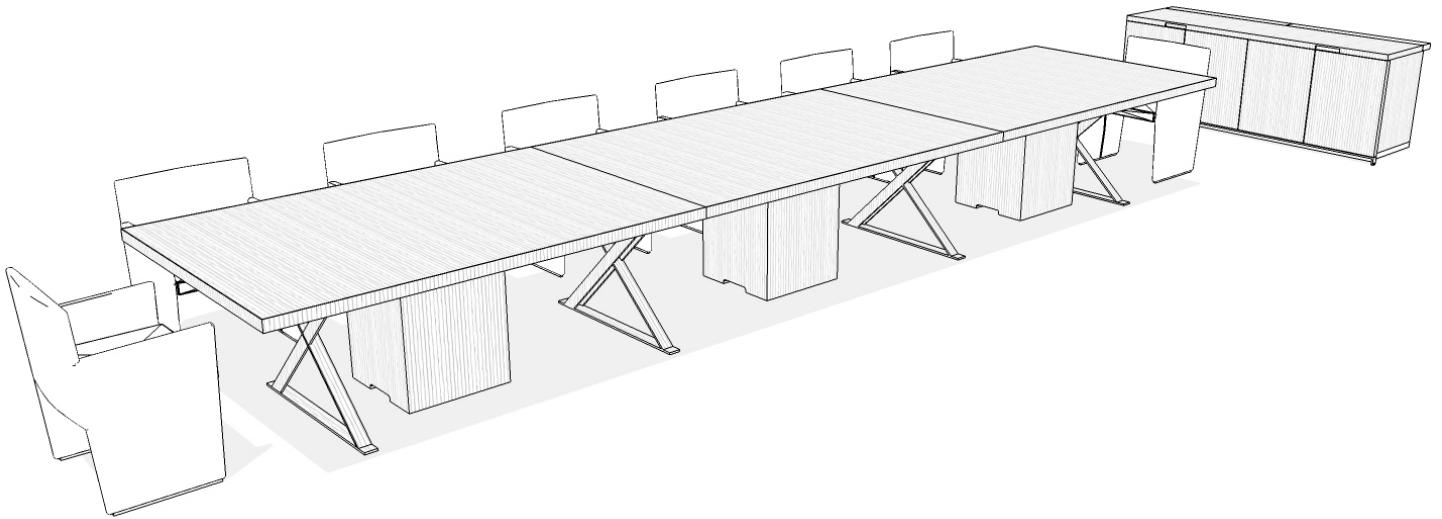

dimensions

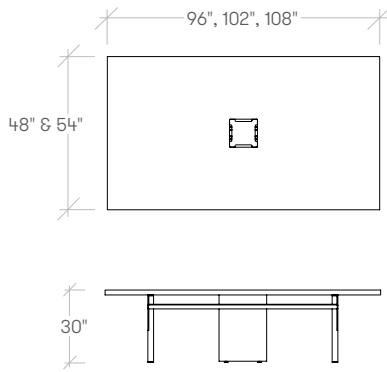

X-Leg Table - ZXST

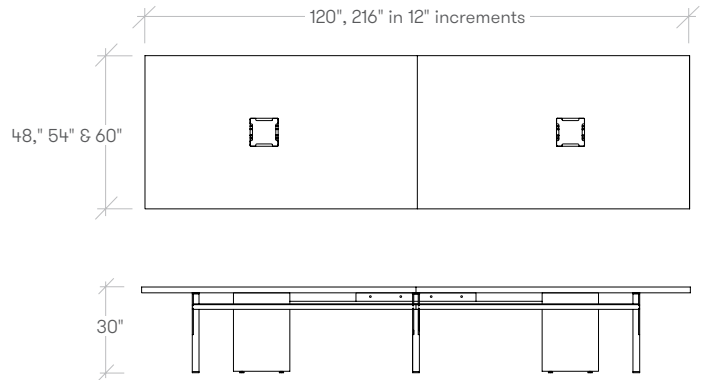

Two piece X-Leg Table - ZXDT

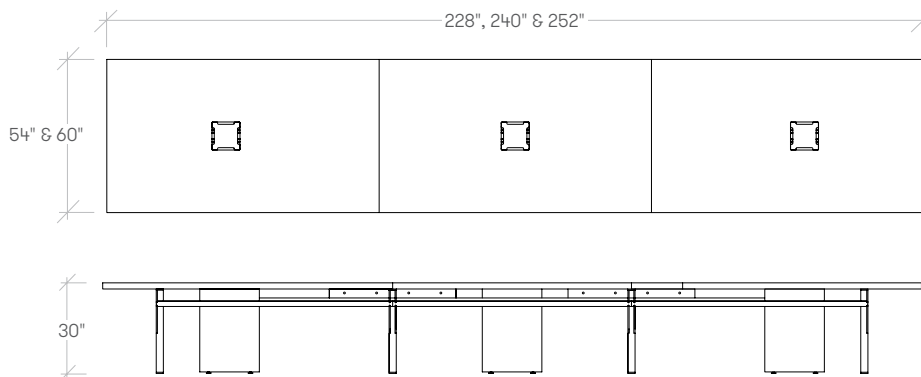

Three piece X-Leg Table - ZXTT

ZXST ac executive one piece x-leg conference table

Product Options

Depth	Width	Height	Center Section	Veneer Finishes
48", 54"	96", 102", 108"	30"	N None D Data/Power G Grommet	AC Veneer Group CWS Custom Wood Stain

Note AC Veneer Group includes these finishes only: (P7) Grey Oak, (P8) Light Brushed Oak and (P9) Smoked Oak
If Grommet is specified add 790 for each instance
If Data/Power is specified add 2253 for each instance

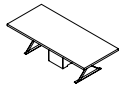

	Price		Price
48"d x 96"w x 30"h Door	22196	54"d x 96"w x 30"h Door	22775
48"d x 102"w x 30"h Door	22821	54"d x 102"w x 30"h Door	23595
48"d x 108"w x 30"h Door	23554	54"d x 108"w x 30"h Door	23554

ZXDT ac executive two piece x-leg conference table

Product Options

Depth	Width	Height	Left Section	Right Section	Veneer Finishes
48", 54", 60"	120", 132", 144", 156", 168", 180", 192", 216"	30"	N None D Data/Power G Grommet	N None D Data/Power G Grommet	AC Veneer Group CWS Custom Wood Stain

Note AC Veneer Group includes these finishes only: (P7) Grey Oak, (P8) Light Brushed Oak and (P9) Smoked Oak
If Grommet is specified add 790 for each instance
If Data/Power is specified add 2253 for each instance

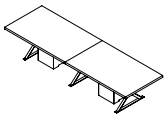

	Price		Price		Price
48"d x 120"w x 30"h	40620	54"d x 120"w x 30"h	41298	60"d x 120"w x 30"h	41965
48"d x 132"w x 30"h	41257	54"d x 132"w x 30"h	42018	60"d x 132"w x 30"h	42696
48"d x 144"w x 30"h	41893	54"d x 144"w x 30"h	42654	60"d x 144"w x 30"h	43415
48"d x 156"w x 30"h	42529	54"d x 156"w x 30"h	43361	60"d x 156"w x 30"h	44146
48"d x 168"w x 30"h	43165	54"d x 168"w x 30"h	44021	60"d x 168"w x 30"h	44865
48"d x 180"w x 30"h	43992	54"d x 180"w x 30"h	44906	60"d x 180"w x 30"h	45790
48"d x 192"w x 30"h	44630	54"d x 192"w x 30"h	45570	60"d x 192"w x 30"h	46506
48"d x 216"w x 30"h	45839	54"d x 216"w x 30"h	46873	60"d x 216"w x 30"h	47893

ZXTT ac executive three piece x-leg conference table

Product Options

Depth	Width	Height	Left Section	Center Section	Right Section	Veneer Finishes
54", 60"	228", 240", 252"	30"	N None D Data/Power G Grommet	N None D Data/Power G Grommet	N None D Data/Power G Grommet	AC Veneer Group CWS Custom Wood Stain

Note AC Veneer Group includes these finishes only: (P7) Grey Oak, (P8) Light Brushed Oak and (P9) Smoked Oak
If Grommet is specified add 790 for each instance
If Data/Power is specified add 2253 for each instance

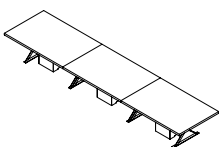

	Price		Price
54"d x 228"w x 30"h Door	63217	60"d x 228"w x 30"h Door	64300
54"d x 240"w x 30"h Door	64115	60"d x 240"w x 30"h Door	65427
54"d x 252"w x 30"h Door	65039	60"d x 252"w x 30"h Door	66186

oval and round tables

Oval and round tables can be used in either office or meeting room setup.

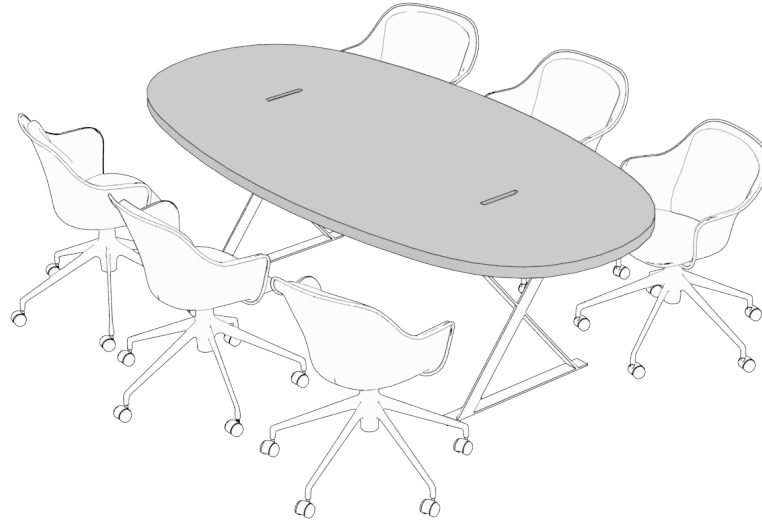

Large Oval X-Leg Table shown with Bookcase

dimensions

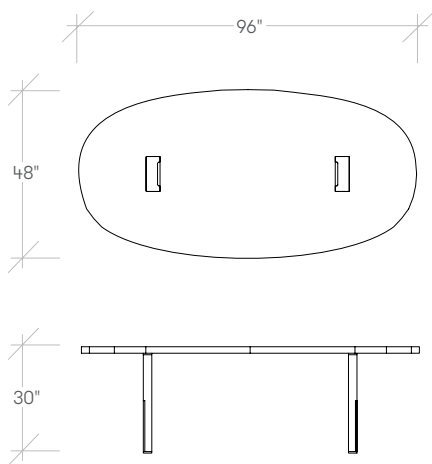

Large Oval X-Leg Table - ZXXO

- Ideally suited to be used as a large desk or as a meeting table
- Option for zero or two grommets

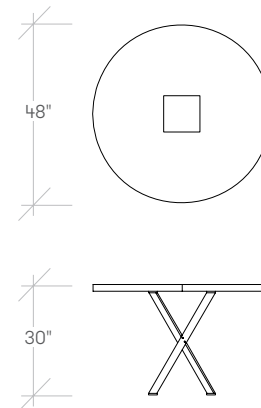

Small Table - ZXRT

- Ideally suited for smaller meeting areas
- Available 48" wide x 30" high
- Option for one grommet

ZXXO ac executive large oval x-leg

Product Options

Depth	Width	Height	Grommet	Veneer Finish
48"	96"	30"	0 None 2 Two	AC Veneer Group CWS Custom Wood Stain

Note AC Veneer Group includes these finishes only: (P7) Grey Oak, (P8) Light Brushed Oak and (P9) Smoked Oak

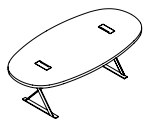

48"d x 96"w x 30"h

Price

No Grommet	Two Grommets
16922	17693

ZXRT ac executive small round table

Product Options

Diameter	Height	Grommet	Veneer Finish
48"	30"	0 None 1 One	AC Veneer Group CWS Custom Wood Stain

Note AC Veneer Group includes these finishes only: (P7) Grey Oak, (P8) Light Brushed Oak and (P9) Smoked Oak



48"dia x 30"h

Price

No Grommet	One Grommet
7884	8270

storage

- Freestanding storage units include credenzas with doors and or drawers and a choice of mobile or freestanding pedestals
- Units are finished on all sides to allow for positioning against a wall or in open spaces
- All units are 24" deep
- Case tops are 1 1/2" thick and all doors and door fronts are 1 1/2" thick with integrated pulls
- Fixed units have a distinctive Chrome base detail
- Sides of units are recessed 1 1/2" from the top and drawer front edge
- Fixed units have a 3/4" leveling capability
- All storage is available with locks

pedestals and credenzas

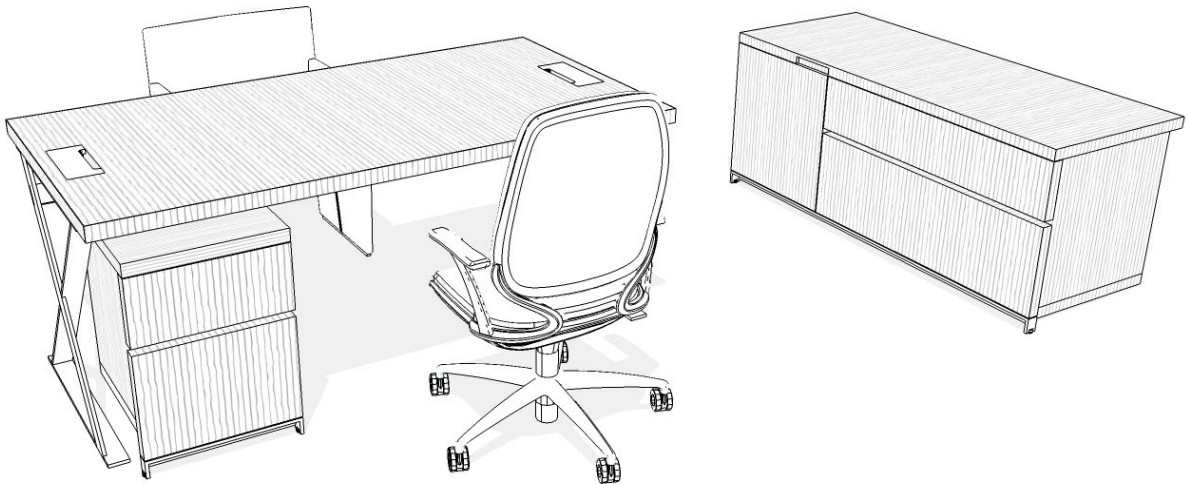

Box/File Pedestal and Low Box/File Pedestal with Wire Access shown

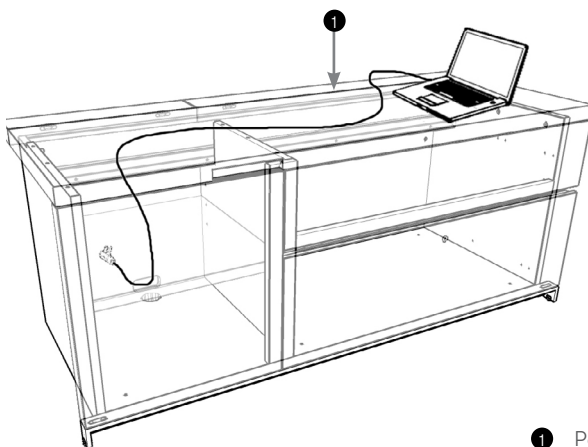

- 1 Power can be routed through a credenza when the top power access door is selected

dimensions

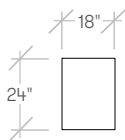

Pedestal - ZXFP

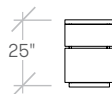

Mobile Pedestal - ZXMP

Includes one box drawer and one file drawer

ZXFP ac executive pedestal

Product Options

Depth	Width	Height	Veneer Finish	Lock
24"	18"	25"	AC Veneer Group CWS Custom Wood Stain	N No Lock L Lock

Note AC Veneer Group includes these finishes only: (P7) Grey Oak, (P8) Light Brushed Oak and (P9) Smoked Oak
If lock is specified, add 161

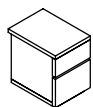

24"d x 18"w x 25"h

Price
4690

ZXMP ac executive mobile pedestal

Product Options

Depth	Width	Height	Veneer Finish	Lock
24"	18"	25"	AC Veneer Group CWS Custom Wood Stain	N No Lock L Lock

Note AC Veneer Group includes these finishes only: (P7) Grey Oak, (P8) Light Brushed Oak and (P9) Smoked Oak
If lock is specified, add 139

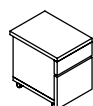

24"d x 18"w x 25"h

Price
4690

dimensions

- Credenzas are 24" deep configurations and include Box/File, Box/Box/File
- Doors or combinations of doors and drawers
- All credenzas have an optional wire access door across the back which allows access to a wire raceway. When the wire management option is chosen, the credenza top will have a wire access door across the back

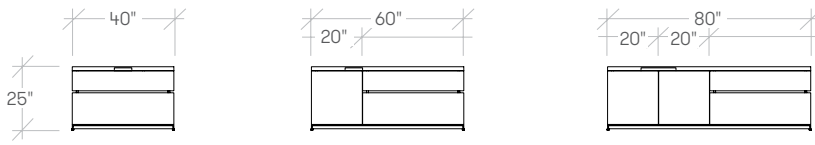

Low Box File Credenza - **ZXBF**

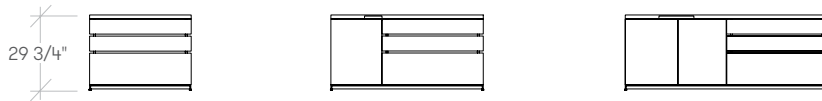

High Box, Box File Credenza - **ZXDB**

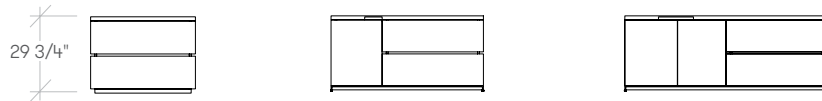

High File, File Credenza - **ZXFF**

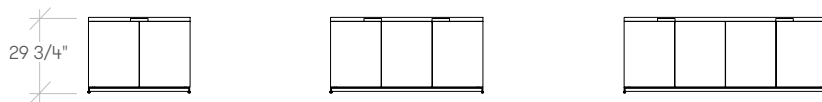

High All-Doors Credenza - **ZXHD**

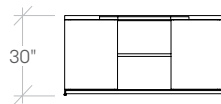

High Open Center with Door Credenza - **ZXHO**

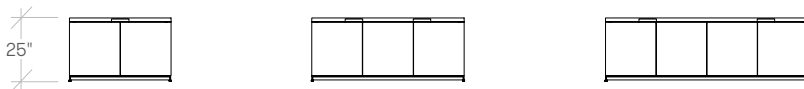

Low All Doors - **ZXLD**

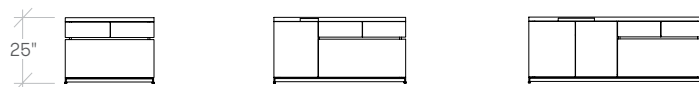

Low, Side-by-Side box - **ZXLF**

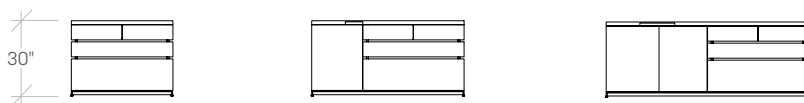

High Side-by-Side Box, Box, File Credenza - **ZXSS**

ZXBF ac executive low box file credenza

Product Options

Depth	Width	Height	Door Orientation	Wire Management	Veneer Finish	Lock
24"	40", 60", 80"	25"	L Left R Right N None	Y Yes N No	AC Veneer Group CWS Custom Wood Stain	N No Lock L Lock

Note AC Veneer Group includes these finishes only: (P7) Grey Oak, (P8) Light Brushed Oak and (P9) Smoked Oak
If lock is specified, add 139

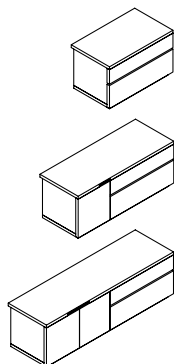

		Price	
		No Wire Management	Wire Management
N	24"d x 40"w x 25"h No Door	9135	9743
L/R	24"d x 60"w x 25"h Door on Left/Right	12523	13168
L/R	24"d x 80"w x 25"h Doors on Left/Right	15864	16471

ZXFF ac executive high file, file credenza

Product Options

Depth	Width	Height	Door Orientation	Wire Management	Veneer Finish	Lock
24"	40", 60", 80"	30"	L Left R Right N None	Y Yes N No	AC Veneer Group CWS Custom Wood Stain	N No Lock L Lock

Note AC Veneer Group includes these finishes only: (P7) Grey Oak, (P8) Light Brushed Oak and (P9) Smoked Oak
If lock is specified, add 188

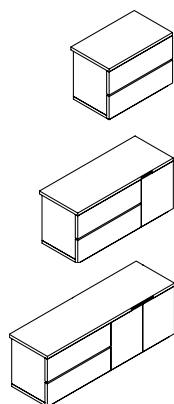

		Price	
		No Wire Management	Wire Management
N	24"d x 40"w x 30"h No Door	9303	10421
L/R	24"d x 60"w x 30"h Door on Left/Right	13702	13843
L/R	24"d x 80"w x 30"h Door on Left/Right	15661	17149

ZXDB ac executive high box, box, file credenza

Product Options

Depth	Width	Height	Door Orientation	Wire Management	Veneer Finish	Lock
24"	40", 60", 80"	30"	L Left R Right N None	Y Yes N No	AC Veneer Group CWS Custom Wood Stain	N No Lock L Lock

Note AC Veneer Group includes these finishes only: (P7) Grey Oak, (P8) Light Brushed Oak and (P9) Smoked Oak
If lock is specified, add 139

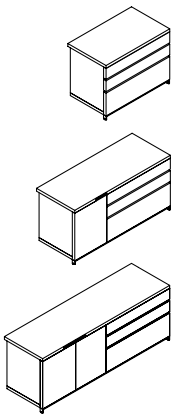

		Price	
		No Wire Management	Wire Management
N	24"d x 40"w x 30"h No Door	9584	10733
L/R	24"d x 60"w x 30"h Door on Left/Right	13037	14377
L/R	24"d x 80"w x 30"h Door on Left/Right	16283	17815

ZXHD ac executive high all door credenza

Product Options

Depth	Width	Height	Wire Management	Veneer Finish	Lock
24"	40", 60", 80"	30"	Y Yes N No	AC Veneer Group CWS Custom Wood Stain	N No Lock L Lock

Note AC Veneer Group includes these finishes only: (P7) Grey Oak, (P8) Light Brushed Oak and (P9) Smoked Oak
If lock is specified, add 132

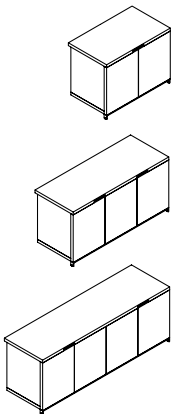

		Price	
		No Wire Management	Wire Management
	24"d x 40"w x 30"h	6757	7875
	24"d x 60"w x 30"h	9207	10508
	24"d x 80"w x 30"h	14983	16471

ZXLD ac executive low all-doors credenza

Product Options

Depth	Width	Height	Wire Management	Veneer Finish	Lock
24"	40", 60", 80"	30"	Y Yes N No	AC Veneer Group CWS Custom Wood Stain	N No Lock L Lock

Note AC Veneer Group includes these finishes only: (P7) Grey Oak, (P8) Light Brushed Oak and (P9) Smoked Oak
If lock is specified, add 139

Price

No Wire Management	Wire Management
6044	7160
8239	9542
13279	14767

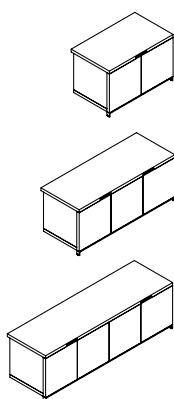

24"d x 40"w x 25"h
24"d x 60"w x 25"h
24"d x 80"w x 25"h

ZXSS ac executive side-by-side box, box, file credenza

Product Options

Depth	Width	Height	Door Orientation	Wire Management	Veneer Finish	Lock
24"	40", 60", 80"	30"	L Left R Right N None	Y Yes N No	AC Veneer Group CWS Custom Wood Stain	N No Lock L Lock

Note AC Veneer Group includes these finishes only: (P7) Grey Oak, (P8) Light Brushed Oak and (P9) Smoked Oak
If lock is specified, add 139

Price

	No Wire Management	Wire Management
N 24"d x 40"w x 30"h No Door	10019	11135
L/R 24"d x 60"w x 30"h Door on Left/Right	13369	14671
L/R 24"d x 80"w x 30"h Door on Left/Right	16471	17961

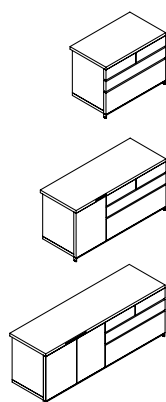

ZXLF ac executive low, side by side box

Product Options

Depth	Width	Height	Door Orientation	Wire Management	Veneer Finish	Lock
24"	40", 60", 80"	25"	L Left R Right N None	Y Yes N No	AC Veneer Group CWS Custom Wood Stain	N No Lock L Lock

Note AC Veneer Group includes these finishes only: (P7) Grey Oak, (P8) Light Brushed Oak and (P9) Smoked Oak
If lock is specified, add 191

Price

	No Wire Management	Wire Management
--	--------------------	-----------------

N	24"d x 40"w x 25"h No Door	9326	10442
L/R	24"d x 60"w x 25"h Door on Left/Right	12527	13867
L/R	24"d x 80"w x 25"h Door on Left/Right	15684	17173

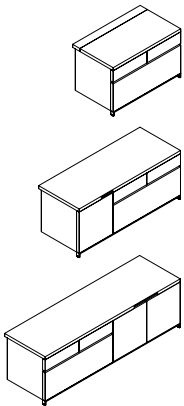

ZXHO ac executive high open center with doors credenza

Product Options

Depth	Width	Height	Wire Management	Veneer Finish	Lock
24"	60"	30"	Y Yes N No	AC Veneer Group CWS Custom Wood Stain	N No Lock L Lock

Note AC Veneer Group includes these finishes only: (P7) Grey Oak, (P8) Light Brushed Oak and (P9) Smoked Oak
If lock is specified, add 191

Price

	No Wire Management	Wire Management
--	--------------------	-----------------

24"d x 60"w x 30"h Door	8752	10057
-------------------------	------	-------

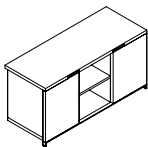



finishes + materials

textiles

The following chart outlines the fabrics that are available for use on B&B Italia Seating.

	Fabric Vendor	ac lounge	jean	metropolitan	posa
<div style="display: flex; align-items: center;"> <div style="width: 15px; height: 10px; background-color: #cccccc; border: 1px solid black; margin-right: 5px;"></div> Available <div style="width: 15px; height: 10px; background-color: white; border: 1px solid black; margin-left: 10px; margin-right: 5px;"></div> Not Available </div>					
Grade 1					
Bitstream (*)	Luum				
Fundamentals	Luum				
Heather Tech	Luum				
Magnify	Luum				
Stimuli	Luum				
Grade 2					
Actuate	Luum				
Complect	Luum				
Complement	Luum				
Cross Dye	Luum				
Crossgrain	Luum				
Decoy	Luum				
Digi Tweed	Luum				
Graviton	Luum				
Intone (*)	Luum				
Megacheck	Luum				
Percept	Luum				
Ultra Durable (*) (**) (***)	Luum				
Grade 3					
Ample	Luum				
Beaded Stripe	Luum				
Biotope	Luum				
Doyenne (*)	Luum				
Ecotone TEMPORARY HOLD	Luum				
Fine Grain (*) (**)	Luum				
Implex	Luum				
Intraweb	Luum				
Manner	Maharam				
Marl Cloth	Luum				
Meld	Maharam				
Messenger	Maharam				
Metaphor	Maharam				
Metric	Maharam				
Milieu	Luum				
Murmur (*)	Maharam				
Muse (*)	Maharam				
Situ	Luum				
Superspun TEMPORARY HOLD	Luum				
Textured Map	Luum				
Twisted Tweed	Luum				

Note

* Bleach Cleanable

** Coated

*** AM Antimicrobial

textiles (continued)

The following chart outlines the fabrics that are available for use on B&B Italia Seating.

	Fabric Vendor	ac lounge	jean	metropolitan	posa
<div style="display: flex; align-items: center;"> <div style="width: 15px; height: 10px; background-color: #cccccc; border: 1px solid black; margin-right: 5px;"></div> Available <div style="width: 15px; height: 10px; background-color: white; border: 1px solid black; margin-left: 10px; margin-right: 5px;"></div> Not Available </div>					
Grade 4					
Brindle (*)	Maharam				
Elastic Wool	Luum				
Formwork	Luum				
High Frequency	Luum				
Grid State	Luum				
Interstice	Luum				
Lariat (*) (**)	Maharam				
Mantle	Maharam				
Medium	Maharam				
Merit	Maharam				
Meta Texture (*) (**)	Luum				
Mode	Maharam				
Modulus (*)	Luum				
Velvet Underground	Luum				
Grade 5					
Adage	Luum				
Cult Classic	Luum				
Keen (**)	Maharam				
Ledger (**)	Maharam				
Monotex (*) (**)	Luum				
Particulate	Luum				
Point Set (*)	Luum				
Refraction	Luum				
Sort (*) (**)	Maharam				
Stature (*) (**)	Maharam				
Subdivide	Luum				
Willow (*)	Maharam				
Grade 6					
Amalgam	Luum				
Basel	Kvadrat				
Bluff (*) (**)	Maharam				
Buffer (*)	Maharam				
Duo Chrome (*)	Luum				
Gust (*)	Maharam				
Haptic	Luum				
Instill (*) (**)	Maharam				
Knurl	Luum				
Levity (*)	Maharam				
Outpress (*)	Luum				
Perilune (*)	Luum				
Photogram	Luum				
Scuba (*) (**)	Maharam				
Soft Static	Luum				
Vector (*)	Luum				

Note

* Bleach Cleanable

** Coated

*** AM Antimicrobial

textiles

The following chart outlines the fabrics that are available for use on B&B Italia Seating.

	Fabric Vendor	ac lounge	jean	metropolitan	posa
<div style="display: flex; align-items: center;"> <div style="width: 15px; height: 10px; background-color: #cccccc; margin-right: 5px;"></div> Available <div style="width: 15px; height: 10px; border: 1px solid black; margin-left: 10px; margin-right: 5px;"></div> Not Available </div>					
Grade 7					
Canvas 2	Kvadrat				
Clara 2	Kvadrat				
Compound (**)	Maharam				
Contrast Slub <small>EXTENDED LEAD TIME</small>	Luum				
Distrupt	Luum				
Ephemera (*)	Luum				
Everyday Boucle	Luum				
Flex Wool	Luum				
Macrotweed	Luum				
Pebble Melange	Luum				
Oeuvre	Luum				
Point-to-Point	Luum				
Remix 3	Kvadrat				
Structured Strip (*)	Luum				
Strum (*) (**)	Maharam				
Tilt Shift Redux	Luum				
Tonica 2	Kvadrat				
Wool Fleck	Luum				
Grade 8					
Barberpole Basket	Luum				
Construct	Luum				
Cosset	Maharam				
Full Wool	Luum				
Homage	Luum				
Line Language	Luum				
Molly 2	Kvadrat				
Geoglyph	Luum				
Prime (*)	Maharam				
Recheck	Kvadrat				
Re-Wool	Kvadrat				
Thangka (*)	Luum				
Wavefield	Luum				
Welded	Luum				

Note

* Bleach Cleanable

** Coated

*** AM Antimicrobial

textiles

The following chart outlines the fabrics that are available for use on B&B Italia Seating.

	Fabric Vendor	ac lounge	jean	metropolitan	posa
Grade 9					
Apt (*) (**)	Maharam				
Divina 3	Kvadrat				
Divina MD	Kvadrat				
Divina Melange 3	Kvadrat				
Equilux	Luum				
Graph Speck	Luum				
Heather Felt	Luum				
Melange Check	Luum				
Melange Nap	Kvadrat				
Savanna	Kvadrat				
Steelcut 2	Kvadrat				
Steelcut Trio 3	Kvadrat				
Super Shearling	Luum				
Top Coat (*) (**) (***)	Luum				
Twill Weave	Kvadrat				
Grade 10					
Anagram	Maharam				
Angulo	Luum				
Colline 2	Kvadrat				
Color Fuse (**)	Luum				
Fiord 2	Kvadrat				
Fleece	Luum				
Hallingdal 65	Kvadrat				
Megapixel	Luum				
Scape	Maharam				
Tonus 4	Kvadrat				
Grade 11					
Rubric	Luum				
Sunniva 2	Kvadrat				
Grade 12					
Hearth	Maharam				
Grade 13					
Coda 2	Kvadrat				
Emergent	Luum				
Reef	Maharam				
Uniform Melange	Kvadrat				

Note

* Bleach Cleanable

** Coated

*** AM Antimicrobial

textiles

The following chart outlines the fabrics that are available for use on B&B Italia Seating.

	Fabric Vendor	ac lounge	jean	metropolitan	posa
Grade 14					
Arc Angle	Luum				
Scale Factor	Luum				
Vidar 3	Kvadrat				
Grade 15					
Waterborn	Kvadrat				
Grade 16					
Mitered	Luum				
Navigate	Luum				
Second Nature	Luum				
Leather					
LB - Merus	Luum				
LC - Pela	Luum				
LD - Fortis	Luum				

frame & back finishes

The following chart outlines the metal frame finishes that are available for use on B&B Italia Seating & Tables

		ac lounge	jean	metropolitan	posa
<input checked="" type="checkbox"/> Available <input type="checkbox"/> Not Available					
Metal Frame Finish					
Chrome	C6				
Bronzed Nickel	F8				
Polished Aluminum	C9				

surface finishes

The following chart outlines the surface finishes that are available for use on B&B Italia products.

		ac executive
<input checked="" type="checkbox"/> Available <input type="checkbox"/> Not Available		
Wood		
Brushed Light Oak	P8	
Grey Oak	P7	
Smoked Oak	P9	

www.studiotk.com

studio tk
3940 US 70 Business Hwy, West
Clayton, North Carolina
27520 USA
Tel 919.464.2920
Fax 919.464.2927

teknion corporation

in canada:
1150 Flint Road
Toronto, Ontario
M3J 2J5 Canada
Tel 866.Teknion
866.835.6466
Fax 416.661.4586

in the usa:
350 Fellowship Road
Mt Laurel, New Jersey
08054 USA
Tel 877.Teknion
877.835.6466
Fax 856.552.5088

other offices located in:
Europe
South and Central America
Middle East, Asia and Russia
For regional contact information go to
www.teknion.com

©, ™ trade marks of Teknion Corporation and/or its subsidiaries or licensed to it. Patents may be pending. Some products may not be available in all markets. Contact your local Teknion representative for availability.

studio | 

JAN24-STUDIO-BB