

# lite wall

## features

The Lite Wall is a freestanding screen that provides visual space division. It has a magnetic connection between screens which helps establish borders for workstations and private spaces. The Lite Wall is easily reconfigurable without tools and visible connections.

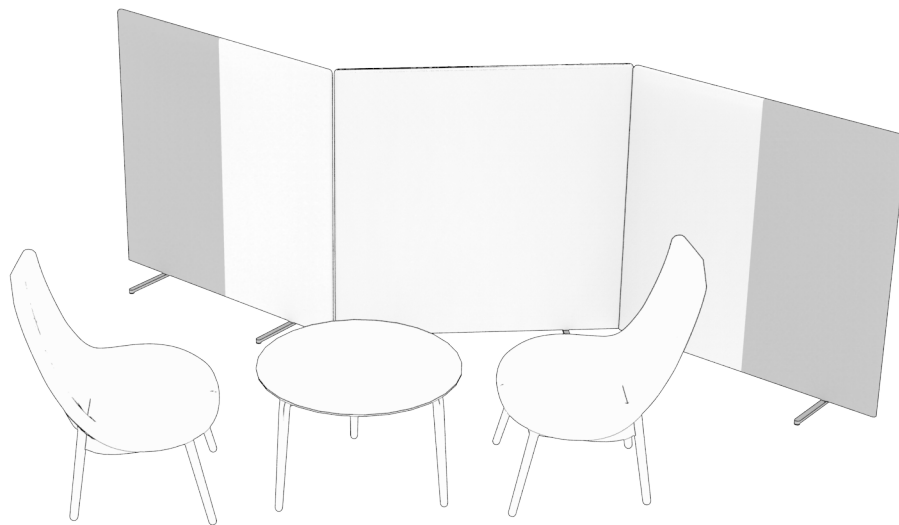

## dimensions

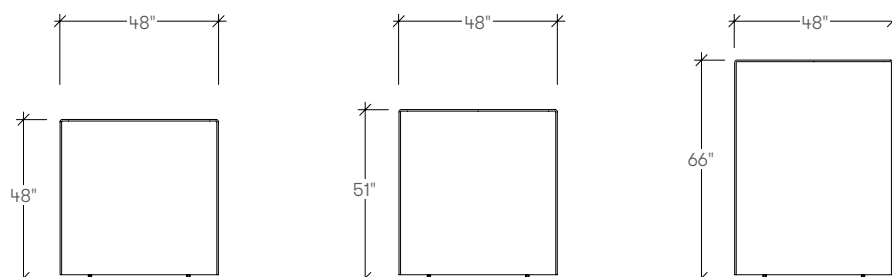

### finishes:

Foot Finish available in:  
Chrome

# lite wall

## planning

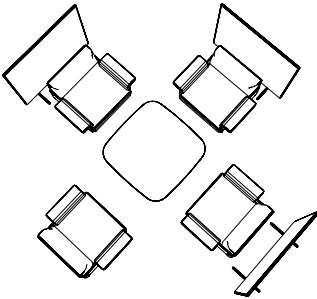

common area privacy

Shown with 48" high Lite Wall screens

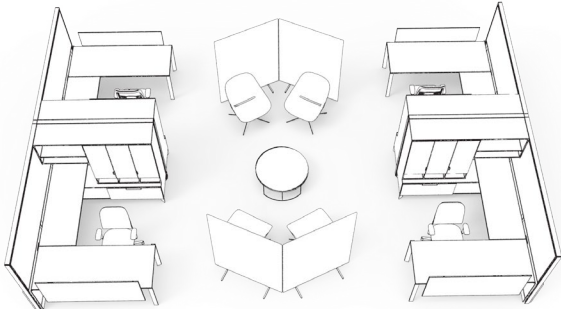

meeting area privacy within workstations

District workstations with Beso Chairs, 66" high Lite Wall screens

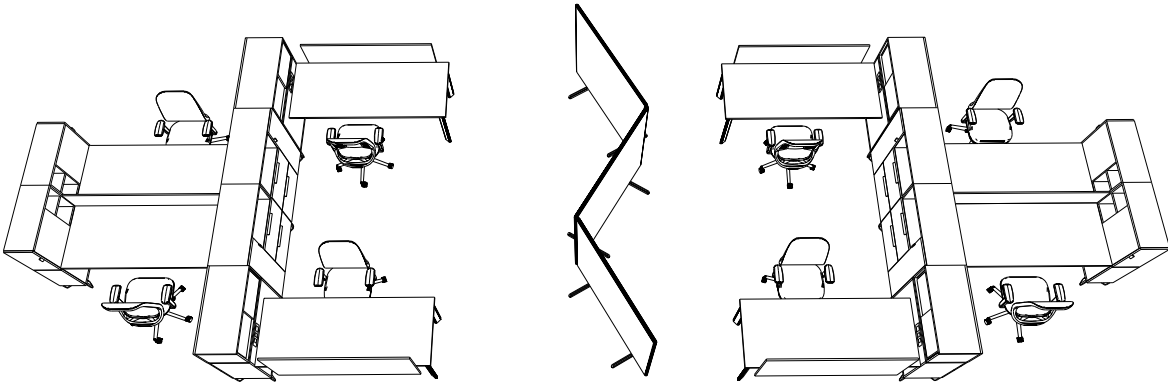

space division between workstations

Shown with District open workstation, 51" high Lite Wall screens

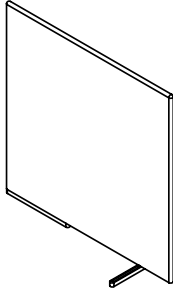

The feet on the Lite Wall pivot under the screen for ease of shipping.

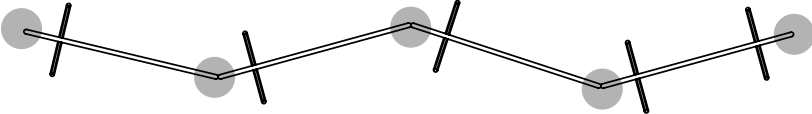

The Lite Wall has an optional magnet on each end to allow screens to attach to one another.

# lite wall

## finish options

Lite Wall can be specified with one fabric, two fabrics (contrasting sides) or divided in the center.

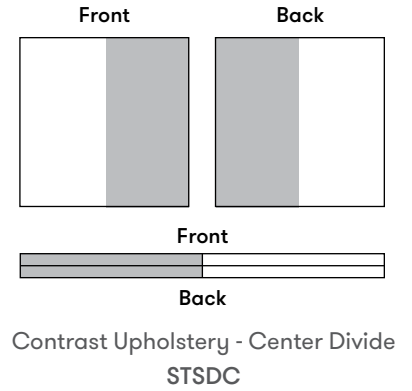
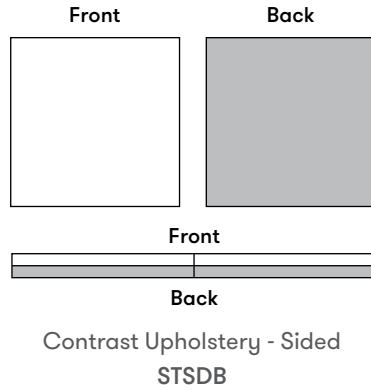
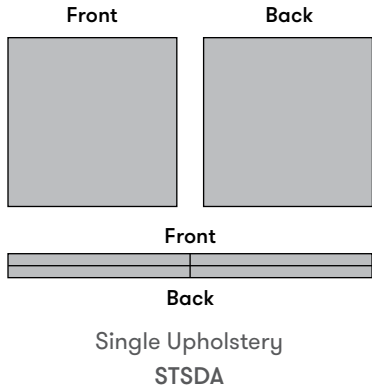

Note The front of the contrasting panel must match the back.

# STSD Lite Wall

## Product Options

Style	Height	Width	Magnet	Upholstery Finish	Frame Finish	Foot Finish
A Full Upholstery	48", 51", 66"	48"	N No Magnet E Magnet	Fabric	8 Arctic	C6 Chrome

Note For Non-Magnet, add \$0  
For Magnet, add \$307

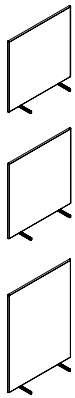

A Full Upholstery  
48"h x 48"w  
51"h x 48"w  
66"h x 48"w

A Full Upholstery  
48"h x 48"w  
51"h x 48"w  
66"h x 48"w

### Panel 1

COM	Gr.1	Gr.2	Gr.3	Gr.4	Gr.5	Gr.6	Gr.7	Gr.8	Gr.9	Gr.10
1471	1551	1587	1618	1653	1680	1702	1724	1751	1778	1804
1529	1609	1645	1676	1711	1738	1760	1782	1809	1836	1862
1599	1699	1743	1782	1827	1860	1888	1916	1949	1982	2016
Gr.11	Gr.12	Gr.13	Gr.14	Gr.15	Gr.16	Gr.17	Gr.18	Gr.19	Gr.20	
1835	1871	1915	1960	2004	2049	2093	2138	2182	2227	
1893	1929	1973	2018	2062	2107	2151	2196	2240	2285	
2055	2099	2155	2210	2266	2321	2377	2432	2488	2543	

# STSD Lite Wall

## Product Options

Style	Height	Width	Magnet	Fabric Finish	Frame Finish	Foot Finish
B Contrast Upholstery - Sided	48", 51", 66"	48"	N No Magnet	Upholstery Finish	8 Arctic	C6 Chrome
C Contrast Upholstery - Center Divide			E Magnet			

Note For Non-Magnet, add \$0  
For Magnet, add \$307

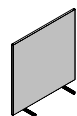

B Contrast Upholstery - Sided  
48"h x 48"w  
51"h x 48"w  
66"h x 48"w

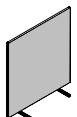

B Contrast Upholstery - Sided  
48"h x 48"w  
51"h x 48"w  
66"h x 48"w

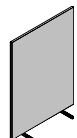

B Contrast Upholstery - Sided  
48"h x 48"w  
51"h x 48"w  
66"h x 48"w

B Contrast Upholstery - Sided  
48"h x 48"w  
51"h x 48"w  
66"h x 48"w

### Panel 1

COM	Gr.1	Gr.2	Gr.3	Gr.4	Gr.5	Gr.6	Gr.7	Gr.8	Gr.9	Gr.10
1471	1551	1587	1618	1653	1680	1702	1724	1751	1778	1804
1529	1609	1645	1676	1711	1738	1760	1782	1809	1836	1862
1599	1699	1743	1782	1827	1860	1888	1916	1949	1982	2016
Gr.11	Gr.12	Gr.13	Gr.14	Gr.15	Gr.16	Gr.17	Gr.18	Gr.19	Gr.20	
1835	1871	1915	1960	2004	2049	2093	2138	2182	2227	
1893	1929	1973	2018	2062	2107	2151	2196	2240	2285	
2055	2099	2155	2210	2266	2321	2377	2432	2488	2543	

### Panel 2

COM	Gr.1	Gr.2	Gr.3	Gr.4	Gr.5	Gr.6	Gr.7	Gr.8	Gr.9	Gr.10
0	42	60	77	95	109	121	132	146	160	174
0	42	60	77	95	109	121	132	146	160	174
0	42	60	77	95	109	121	132	146	160	174
Gr.11	Gr.12	Gr.13	Gr.14	Gr.15	Gr.16	Gr.17	Gr.18	Gr.19	Gr.20	
190	209	232	255	278	302	325	348	371	394	
190	209	232	255	278	302	325	348	371	394	
190	209	232	255	278	302	325	348	371	394	

STSD Lite Wall (continued)

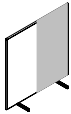
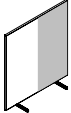
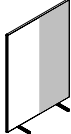
		<b>Panel 1</b>										
		COM	Gr.1	Gr.2	Gr.3	Gr.4	Gr.5	Gr.6	Gr.7	Gr.8	Gr.9	Gr.10
	C Contrast Upholstery - Center Divide											
	48"h x 48"w	1471	1551	1587	1618	1653	1680	1702	1724	1751	1778	1804
	51"h x 48"w	1529	1609	1645	1676	1711	1738	1760	1782	1809	1836	1862
	66"h x 48"w	1599	1699	1743	1782	1827	1860	1888	1916	1949	1982	2016
		Gr.11	Gr.12	Gr.13	Gr.14	Gr.15	Gr.16	Gr.17	Gr.18	Gr.19	Gr.20	
	C Contrast Upholstery - Center Divide											
	48"h x 48"w	1835	1871	1915	1960	2004	2049	2093	2138	2182	2227	
	51"h x 48"w	1893	1929	1973	2018	2062	2107	2151	2196	2240	2285	
	66"h x 48"w	2055	2099	2155	2210	2266	2321	2377	2432	2488	2543	
		<b>Panel 2</b>										
		COM	Gr.1	Gr.2	Gr.3	Gr.4	Gr.5	Gr.6	Gr.7	Gr.8	Gr.9	Gr.10
	C Contrast Upholstery - Center Divide											
	48"h x 48"w	0	42	60	77	95	109	121	132	146	160	174
	51"h x 48"w	0	42	60	77	95	109	121	132	146	160	174
	66"h x 48"w	0	42	60	77	95	109	121	132	146	160	174
		Gr.11	Gr.12	Gr.13	Gr.14	Gr.15	Gr.16	Gr.17	Gr.18	Gr.19	Gr.20	
	C Contrast Upholstery - Center Divide											
	48"h x 48"w	190	209	232	255	278	302	325	348	371	394	
	51"h x 48"w	190	209	232	255	278	302	325	348	371	394	
	66"h x 48"w	190	209	232	255	278	302	325	348	371	394	