

tables &
conferencing

price guide

10.24.2022



teknion

INDEX 7

PRICE & PRODUCT GUIDE 11

introduction

where to find the information you need

Teknion provides an array of tools and information resources to help you get things done simply and easily. From product pricing to application guidelines to online planning suggestions, you will find what you need when you need it.

guide contents

This guide contains all the information you need to order this product through your specification software. The Introduction section provides everything you need to get started, including an index for product reference. The Application Guide section contains detailed specification guidelines, application and planning information to help you plan your project correctly. The Price Guide sections provide detailed pricing and specification information by product type. Available online at www.teknion.com.

where to find the information you need

All Teknion marketing materials are available online at www.teknion.com, including:

price & product guide

application guide

planning tool

installation guides

fabrics & finishes

product photography & drawings

weights & volumes

order forms

warranty/terms & conditions of sale

xpress program guide

teknion forms

The following forms are available online at www.teknion.com, to help you specify and place your order if required:

teknipaint

If you require a custom paint color match, you must submit a TekniPaint form.

using your own material (COM)

If you wish to use your own material on fabric-covered products, you must submit a completed COM form including a sample upholstery and safety testing. A COM Order Information Sheet must also be submitted. This form captures all relevant ordering and tracking information. A COM Request for Yardage Calculation form may be sent to Teknion for preliminary yardage requirements.

placing a manual order

Complete an Order Cover Sheet with the information we need to fill your order. This is the most important step. If the Order Cover Sheet is not complete and correct, the order may be delayed.

key requirements

If you require that certain pieces share the same locks you will need to specify Set of Keys Alike (SOKL) located in the Price and Product Guide.

user feedback

How is our marketing material working for you?

Feedback from the user is very important to the quality of Teknion's marketing material. We ask that if you have suggestions on how you think we could improve content OR if you have found an error, that you contact your Teknion Technical Services department.

Section Contents	Product Code	Page No.
INTRODUCTION		
Tables & Conferencing Overview		9
Where to find the information you need		5
OCCASIONAL TABLES		
General Information		15
CANA		
End Table	ZCOTE	16
Coffee Table	ZCOTC	17
WESTCOAST		
End Table	ZWOTE	18
Coffee Table	ZWOTC	19
TIFFANY		
Round Table	ZTOTO	20
Oval Table	ZTOTU	21
Square Table	ZTOTQ	22
End Table	ZTOTE	23
Coffee Table	ZTOTC	24
Sofa Table	ZTOTS	25
CONFERENCE TABLES		
General Information		29
Grain Designs		32
Edge Details		30
Table Base Requirements – Base Quantity, Knee Space and Seating Information		34
CONFERENCE TABLES		
Round Table Top	ZCTO	40
Square Table Top	ZCTQ	41
Modified Square Table Top	ZCTMQ	42
Elliptical Table Top	ZCTEL	43
Rectangular Table Top	ZCTR	44
Modified Rectangular Table Top	ZCTMR	46
Racetrack Table Top	ZCTT	48
Boat Table Top	ZCTB	50
TABLE BASES		
Round Leg Metal Base	ZTB0L	52
Mobile Round Leg Metal Base	ZTB0LC	53
Panel Base	ZTB20	54
Cylinder Base	ZTB21	55
Cube Base	ZTB22	56
Continuous Rectangular Base	ZTB35	57
Continuous Racetrack Base	ZTB34	58
Metal Column End Base	ZTB44	59
Metal Column X Base	ZTB43	60
Double Metal Column End Base	ZTB49	61

Section Contents	Product Code	Page No.
ELECTRICS		
Shadow Spider Box	ZAGSH	62
Phantom Spider Box	ZAGPS	63
Flip-Up Electrical Box – Standard	ZAGFUS	64
Flip-Up Electrical Box with		
Half Moon Cut-Out Cable Access	ZAGFUHA	65
Flip-Up Electrical Box with		
Black Nylon Brush Cable Access	ZAGFUNA	66
Grommets	ZAG	67
CONFERENCING		
General Information		70
ACCESSORIES		
Canva Visual Board	ZAVB	71
Westcoast Visual Board	ZWVP	72
Projection Screen	ZAPRS	73

tables & conferencing overview

Teknion's offering of sleek, sophisticated end tables, corner tables, coffee tables and sofa tables creates an ambiance for executive offices, reception areas and boardrooms. Occasional tables can be ordered in an array of shapes, sizes and configurations. Finishes include your choice of rich cherry veneers, veneer lay-ups, marble and frosted glass tops. Occasional tables can also be customized to meet specific requirements.



price & product guide

price & product guide

OCCASIONAL TABLES	13
CONFERENCE TABLES	27
CONFERENCING	69

occasional tables

product map

cana

Z C O T E End Table

Page 16

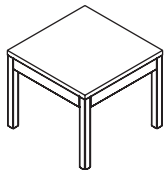

Z C O T C Coffee Table

Page 17

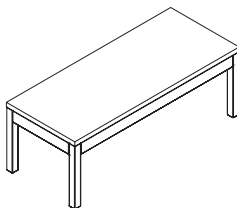

westcoast

Z W O T E End Table

Page 18

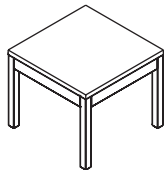

Z W O T C Coffee Table

Page 19

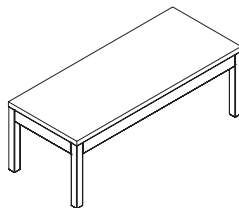

Z T O T O Round Table

Page 20

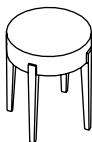

No Shelf

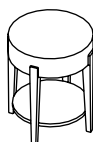

With Shelf

Z T O T U Oval Table

Page 21



No Shelf

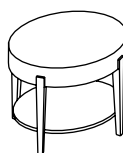

With Shelf

Z T O T Q Square Table

Page 22

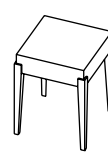

No Shelf

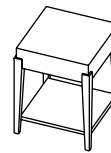

With Shelf

tiffany

Z T O T E End Table

Page 23

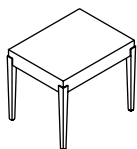

No Shelf

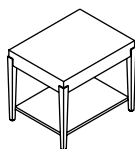

With Shelf

Z T O T C Coffee Table

Page 24

Round
36" dia

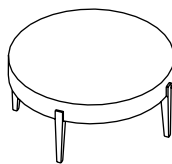

No Shelf

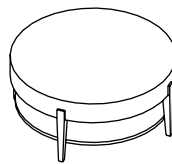

With Shelf

Rectangular
42" w, 20" d

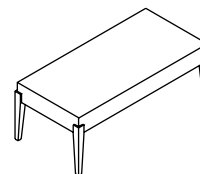

No Shelf

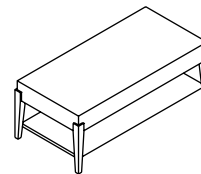

With Shelf

product map

Z T O T S Sofa Table

Page 25

tiffany

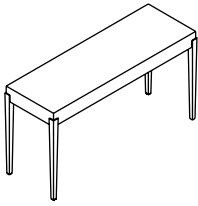

No Shelf

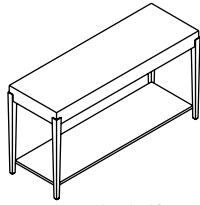

With Shelf

general information

GENERAL:

All dimensional codes (listed throughout the text and under options) are nominal figures – they are not actual dimensions.

CANA AND WESTCOAST:

Canas are characterized by their well crafted Pencil Radius or Radius edge detail in solid hardwood.



Pencil Radius Radius

Westcoast offers five different edge styles in solid hardwood:



Bevel Classic Arch Dome Reed

TIFFANY:

Tiffany Tables are designed to compliment a variety of surroundings, yet stands alone as an essential design statement. The legs celebrate the bold top as a ring setting celebrates its stone.

FINISHES:

For details on the finishes with codes available for occasional Tables, please refer to the Wood/Casegoods Introduction booklet.

Please refer to Teknion’s Fabrics & Finishes Program guide to view finish sample cards and to order individual finish samples.

Custom Wood Stain

For custom wood finishes (ZCCWS) add 676 list per match. This is a one time matching charge. Please see the Wood/Casegoods Introduction booklet for details.

ZCOTE End Table

NOTES

Please see finish listing with codes in the Wood / Caseloads Introduction Booklet.

While sizing is shown in both imperial and metric, products need to be ordered using imperial dimensions.

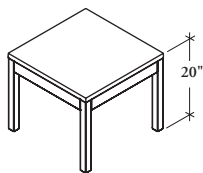

PRODUCT OPTIONS

Width	Finish	Edge Detail
24, 30	Natural Veneer Custom Wood Stain	CG Pencil Edge CP Radius Edge

SAMPLE ORDER CODE

ZCOTE 24	UH	CG
----------	----	----

DIMENSIONS INCHES / MM

W
24 / 610
30 / 762

PRICING

Pencil Edge	Radius Edge
2024	2119
2211	2321

To order a Custom Color for Occasional Tables please use the code ZCCWS. A one time 1267 list charge per color applies.

NOTES

Please see finish listing with codes in the Wood / Casegoods Introduction Booklet.

While sizing is shown in both imperial and metric, products need to be ordered using imperial dimensions.

**ZCOTC
Coffee Table**

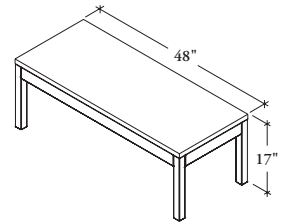

PRODUCT OPTIONS

Depth	Finish	Edge Detail
20, 24	Natural Veneer Custom Wood Stain	CG Pencil Edge CP Radius Edge

SAMPLE ORDER CODE

ZCOTC 20	UH	CG
----------	----	----

**DIMENSIONS
INCHES / MM**

D
20 / 508
24 / 610

PRICING

Pencil Edge	Radius Edge
2241	2304
2380	2452

To order a Custom Color for Occasional Tables please use the code ZCCWS. A one time 1267 list charge per color applies.

occasional tables – westcoast

ZWOTE End Table

NOTES

Please see finish listing with codes in the Wood / Caseloads Introduction Booklet.

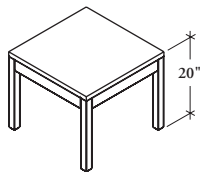

PRODUCT OPTIONS

Width	Finish	Edge Detail
24, 30	Natural Veneer Custom Wood Stain	JR Bevel JS Classic JT Arch JV Dome JW Reed

SAMPLE ORDER CODE

ZWOTE 24	UH	JR
-----------------	-----------	-----------

DIMENSIONS INCHES / MM

W
24 / 610
30 / 762

PRICING

2427
2712

To order a Custom Color for Occasional Tables please use the code ZCCWS. A one time 1267 list charge per color applies.

NOTES

Please see finish listing with codes in the Wood / Casegoods Introduction Booklet.

**ZWOTC
Coffee Table**

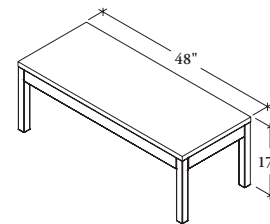

PRODUCT OPTIONS

Depth	Finish	Edge Detail
20, 24	Natural Veneer Custom Wood Stain	JR Bevel JS Classic JT Arch JV Dome JW Reed

SAMPLE ORDER CODE

ZWOTC 20	UH	JR
-----------------	-----------	-----------

**DIMENSIONS
INCHES / MM**

PRICING

D	
20 / 508	2699
24 / 610	2854

To order a Custom Color for Occasional Tables please use the code ZCCWS. A one time 1267 list charge per color applies.

occasional tables – tiffany

Z T O T O Round Table

NOTES

Not all diameter/height combinations are available. Please see pricing for exact offering.
Please see finish listing with codes in the Wood / Casegoods Introduction Booklet.

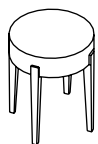

No Shelf

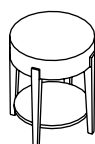

With Shelf

PRODUCT OPTIONS

Shelf Option	Diameter	Height	Finish
N No Shelf	18, 24	22 22.5	Natural Veneer
S With Shelf		26 26.5	Custom Wood Stain

SAMPLE ORDER CODE

ZTOTO N	24	22	UH
---------	----	----	----

DIMENSIONS INCHES / MM

D	W
18 / 457	22 / 559
18 / 457	26 / 660
24 / 610	22 / 559

PRICING

No Shelf (N)	With Shelf (S)
3175	3398
3257	3482
3396	3652

To order a Custom Color for Occasional Tables please use the code ZCCWS. A one time 1267 list charge per color applies.

NOTES

Please see finish listing with codes in the Wood / Casegoods Introduction Booklet.

Z T O T U
Oval Table

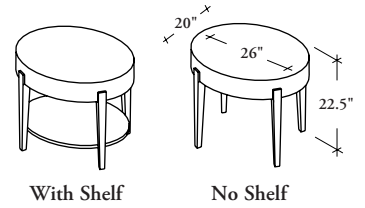

PRODUCT OPTIONS

Shelf Option	Finish
N No Shelf	Natural Veneer
S With Shelf	Custom Wood Stain

SAMPLE ORDER CODE

ZTOTU N	UH
----------------	-----------

PRICING

No Shelf (N)	With Shelf (S)
4139	4585

To order a Custom Color for Occasional Tables please use the code ZCCWS. A one time 1267 list charge per color applies.

ZTOTQ Square Table

NOTES

Please see finish listing with codes in the Wood / Caseloads Introduction Booklet.

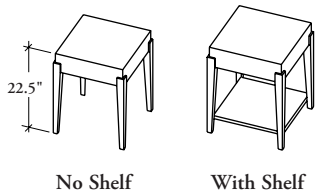

PRODUCT OPTIONS

Width	Shelf Option	Finish
18, 24	N No Shelf S With Shelf	Natural Veneer Custom Wood Stain

SAMPLE ORDER CODE

ZTOTQ 24	N	CG
----------	---	----

DIMENSIONS INCHES / MM

W
18 / 457
24 / 610

PRICING

No Shelf (N)	With Shelf (S)
2544	2749
2963	3183

To order a Custom Color for Occasional Tables please use the code ZCCWS. A one time 1267 list charge per color applies.

NOTES

Please see finish listing with codes in the Wood / Casegoods Introduction Booklet.

Z T O T E
End Table

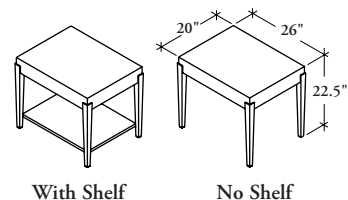

PRODUCT OPTIONS

Shelf Option	Finish
N No Shelf	Natural Veneer
S With Shelf	Custom Wood Stain

SAMPLE ORDER CODE

ZTOTE N	UH
---------	----

PRICING

No Shelf (N)	With Shelf (S)
3079	3311

To order a Custom Color for Occasional Tables please use the code ZCCWS. A one time 1267 list charge per color applies.

occasional tables – tiffany

Z T O T C

Coffee Table

NOTES

Please see finish listing with codes in the Wood / Caseloads Introduction Booklet.

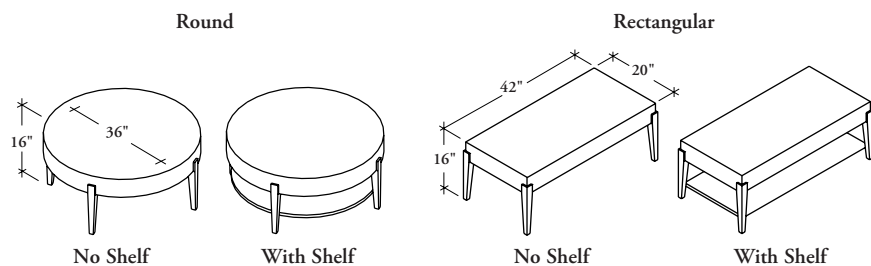

PRODUCT OPTIONS

Style	Shelf Option	Finish
O Round	N No Shelf	Natural Veneer
R Rectangular	S With Shelf	Custom Wood Stain

SAMPLE ORDER CODE

ZTOTC O	N	CG
---------	---	----

STYLE

PRICING

	No Shelf (N)	With Shelf (S)
O	4460	4881
R	3744	4074

To order a Custom Color for Occasional Tables please use the code ZCCWS. A one time 1267 list charge per color applies.

NOTES

Please see finish listing with codes in the Wood / Casegoods Introduction Booklet.

**Z T O T S
Sofa Table**

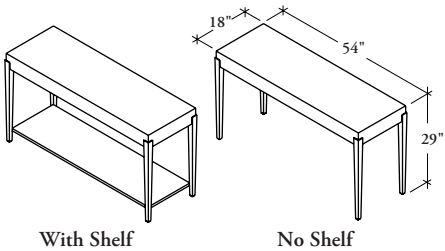

PRODUCT OPTIONS

Shelf Option	Finish
N No Shelf	Natural Veneer
S With Shelf	Custom Wood Stain

SAMPLE ORDER CODE

ZTOTS N	UH
---------	----

PRICING

No Shelf (N)	With Shelf (S)
4139	4671

To order a Custom Color for Occasional Tables please use the code ZCCWS. A one time 1267 list charge per color applies.

conference tables

table tops

Z C T Table Tops

Page 40

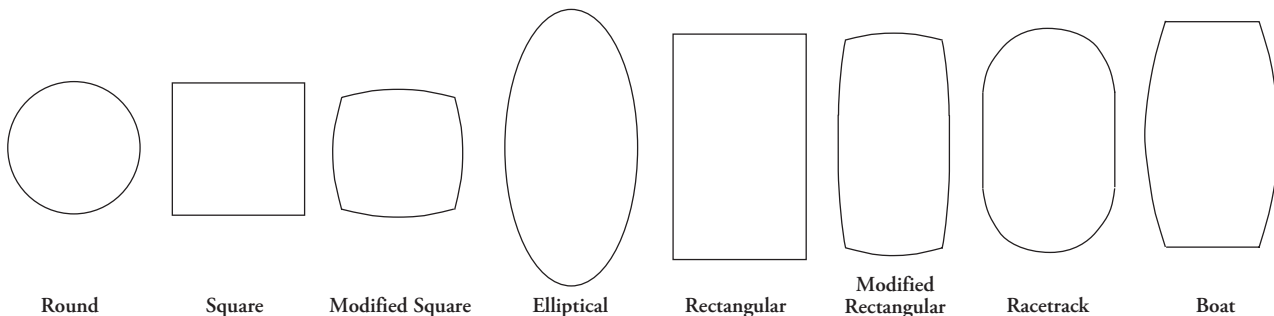
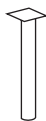

table bases

Z T B O L Round Leg Metal Base

Page 52



Z T B O L C Mobile Round Leg Metal Base

Page 53



Z T B 2 0 Panel Base

Page 54

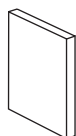

Z T B 2 1 Cylinder Base

Page 55



Z T B 2 2 Cube Base

Page 56

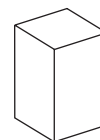

Z T B 3 5 Continuous Rectangular Base

Page 57

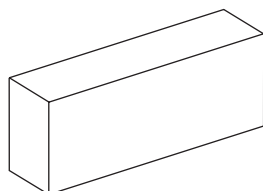

Z T B 3 4 Continuous Racetrack Base

Page 58

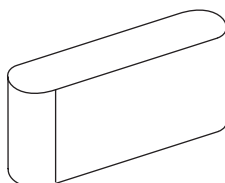

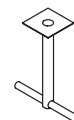

Z T B 4 4 Metal Column End Base

Page 59

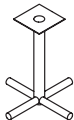
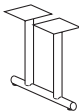

product map

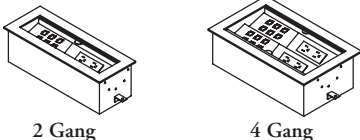
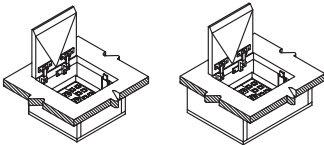
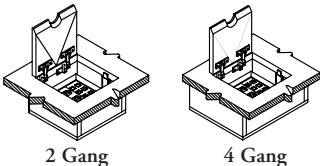
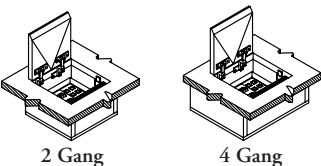
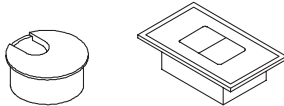
table	<p>Z T B 4 3 Metal Column X Base</p> <p>Page 60</p> 	<p>Z T B 4 9 Double Metal Column End Base</p> <p>Page 61</p> 	
	<p>Z A G S H Shadow Spider Box</p> <p>Page 62</p> 	<p>Z A G P S Phantom Spider Box</p> <p>Page 63</p>  <p>2 Gang 4 Gang</p>	<p>Z A G F U S Flip-Up Electrical Box – Standard</p> <p>Page 64</p>  <p>2 Gang 4 Gang</p>
electrics bases	<p>ZAGFUHA Flip-Up Electrical Box with Half Moon Cut-Out Cable Access</p> <p>Page 65</p>  <p>2 Gang 4 Gang</p>	<p>ZAGFUNA Flip-Up Electrical Box with Black Nylon Brush Cable Access</p> <p>Page 66</p>  <p>2 Gang 4 Gang</p>	<p>Z A G Grommets</p> <p>Page 67</p> 

general information

GENERAL:

All dimensional codes (listed throughout the text and under options) are nominal figures – they are not actual dimensions.

The extensive offering of conference tables are manufactured using select veneers and solids. Please note that the natural characteristics of wood veneer and wood solids may contribute to a variation of finish grain, tone and color.

Tables 96" and shorter in length have one piece tops with the veneer grain running parallel to the longest table top dimension.

Tables greater than 96" in length up to and including 192" in length have two piece tops with the veneer grain running parallel to the shortest table top dimension.

Tables greater than 192" in length have three piece tops with the veneer grain running parallel to the shortest table top dimension.

The dealer is responsible for confirming that tops will fit in an elevator or other site access.

Round, square and modified square tops that are greater than 60" are two pieces.

T6 patterned grain tops have a 12" center square. Finish of this square can be specified in veneer or Platinum painted MDF. Table top length must be a multiple of table top width.

All conference table edge details and most table bases are available on conference tables of all shapes and sizes. Combining these with corner details, veneer patterns and finishes allows the specifier to select a table design that meets the aesthetic and functional requirements of their project.

FINISHES:

For details on the finishes available for these products, please see the Wood/Casegoods Introduction booklet.







Please refer to Teknion's Fabrics & Finishes Program guide to view finish sample cards and to order individual finish samples.

Custom Wood Stain



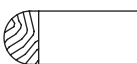
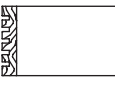

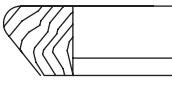
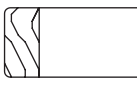
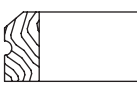
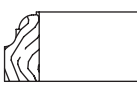
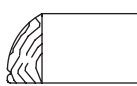
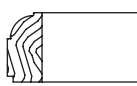

For custom wood finishes add 676 list per match. This is a one time matching charge. Please see the Wood/Casegoods Introduction booklet for details.

edge details – grades 1 & 2

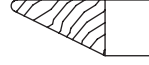
grade 1

	(EA) Pencil Radius 1 5/32" high x 1/8" wide edge
	(EB) Thick Pencil Radius 1 5/32" high x 3/4" wide edge
	(EC) Radius 1 5/32" high x 3/4" wide edge
	(ED) Bullnose 1 5/32" high x 3/4" wide edge
	(EF) Reed Square 1 1/2" high x 5/16" wide edge
	(EG) Bead 1 1/2" high x 5/16" wide edge
	(EH) Cyma 1 1/2" high x 5/16" wide edge
	(EJ) Round Reverse Bevel 1 1/2" high x 1/2" wide edge
	(EK) Thick Pencil Radius 1 1/2" high x 3/4" wide edge
	(JR) Westcoast Bevel 1 1/2" high x 3/4" wide edge
	(JS) Westcoast Classic 1 1/2" high x 3/4" wide edge
	(JT) Westcoast Arch 1 1/2" high x 3/4" wide edge
	(JV) Westcoast Dome 1 1/2" high x 3/4" wide edge
	(JW) Westcoast Reed 1 1/2" high x 3/4" wide edge

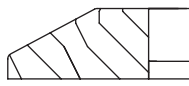
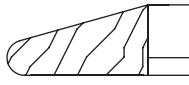
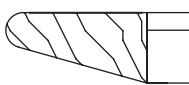
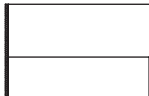
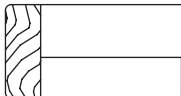
grade 2

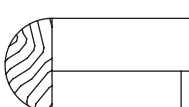
	(EL) Taper 1 3/16" high x 2" wide edge
	(EN) Slope Round 1 1/4" high x 2 1/2" wide edge
	(EP) Drop Bullnose 1 1/2" high x 2" wide edge
	(EQ) Slope Bevel 1 1/2" high x 2 1/2" wide edge
	(ET) Wide Bevel 1 1/2" high x 3" wide edge
	(EU) Waterfall 1 1/2" high x 3" wide edge
	(EV) Reverse Waterfall 1 1/2" high x 3" wide edge
	(EW) Flat 1 3/4" high x 1/16" wide edge
	(EX) Pencil Radius 1 3/4" high x 3/4" wide edge
	(EY) Radius 1 3/4" high x 1" wide edge
	(EZ) Bullnose 1 3/4" high x 1" wide edge

edge details – grades 3 & 4

grade 3

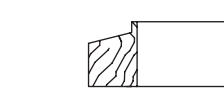

(TA)
Notched Bevel
1 1/2" high solid edge,
1" high sloping top

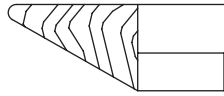

(TC)
Reverse Bevel
2" high x 3" wide edge

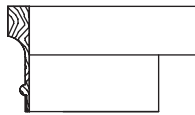

(TD)
Cove and Bead
2 7/16" high solid edge,
3/8" high decorative edge

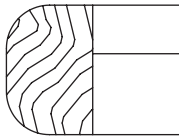

(TH)
Double Radius
3" high x 2" wide edge

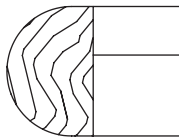

(TJ)
Bullnose
3" high x 2" wide edge

grade 4

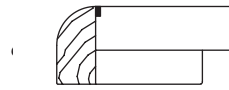

(TK)
Inlaid Radius
1 3/4" high solid edge x 1" wide
1/8" inlay



(TM)
Inlaid Bullnose
1 3/4" high x 1" wide edge
1/8" inlay



(TQ)
Inlaid Cove and Bead
27/16" high x 3/8" wide edge and
1/8" solid Black pin stripe in top

corner detail options

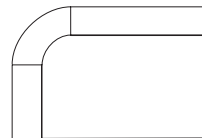

(2)
2" inside radius top corner

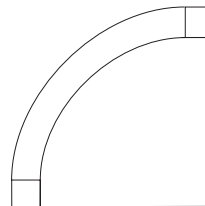

(4)
4.5" inside radius top corner

grain designs

standard

patterned

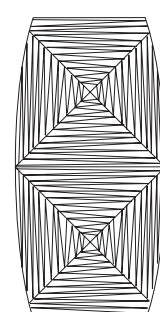
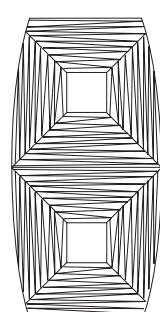
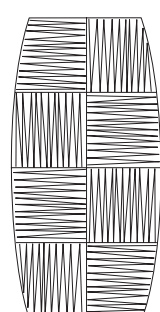
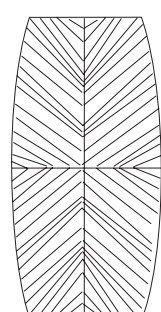
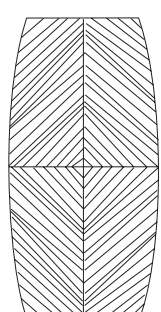
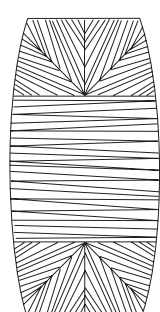
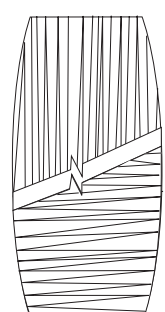
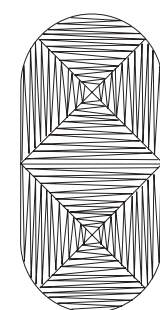
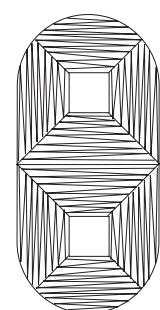
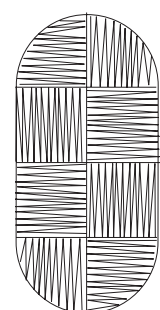
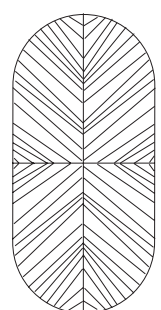
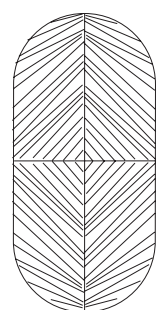
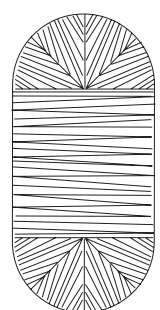
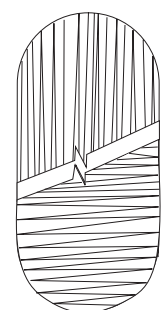
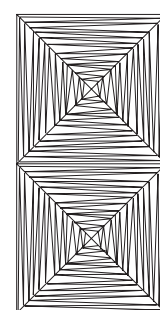
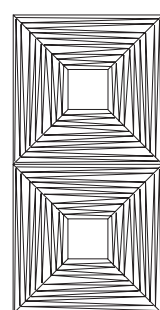
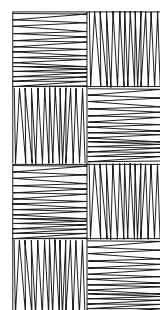
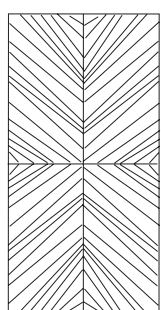
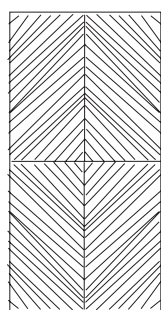
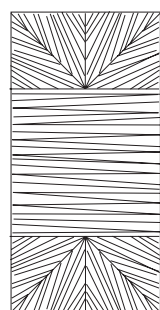
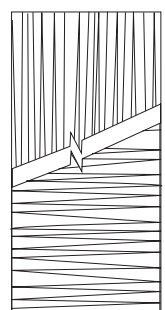
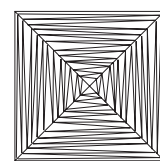
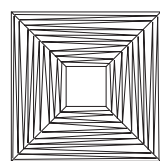
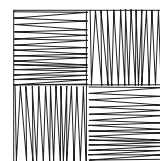
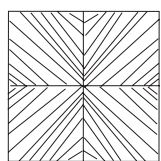
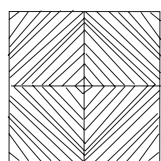
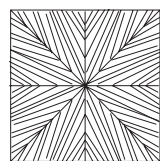
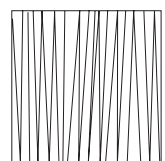
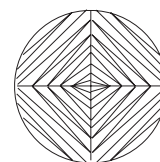
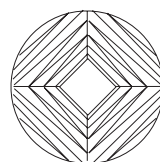
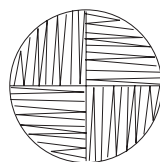
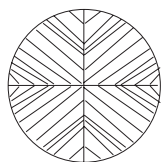
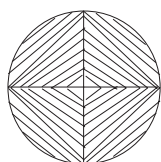
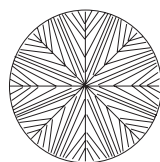
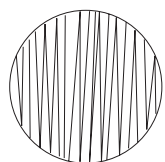

T1
Standard

Standard grain runs parallel to width on tables over 96"

T2
Sunburst

T3
Diamond

T4
Reverse Diamond

T5
Checkerboard

T6
Pyramid

Center square finish in painted MDF or any veneer – grain in one direction only

T7
Full Pyramid

Without the center square

Table top length must be a multiple of table top widths for both pyramid designs

table & base compatibility chart

			Individual Legs		Cylinder		Cube		Panel	
			qty	knee space	qty/dimen	knee space	qty/dimen	knee space	qty/dimen	knee space end/side
Round Tables 	table top dimensions	seating capacity								
	36	4	n/a	n/a	n/a	n/a	n/a	n/a	n/a	n/a
	42	4-5	n/a	n/a	1 / 18	12	1 / 18	8.3	n/a	n/a
	48	5-6	4	7	1 / 18	15	1 / 18	11.3	n/a	n/a
	54	5-7	4	12	1 / 24	15	1 / 24	10	n/a	n/a
	60	6-7	4	12.5	1 / 24	18	1 / 24	13	n/a	n/a
	66	6-8	4	14	1 / 30	19	1 / 28	13.2	n/a	n/a
	72	7-8	5	15.5	1 / 30	22	1 / 28	16.2	n/a	n/a
	84	8-10	6	18.5	1 / 42	21	1 / 42	12.3	n/a	n/a
	96	10-12	6	21-5	1 / 42	27	1 / 42	18.3	n/a	n/a
108	11-13	6	21.5	1 / 48	30	n/a	n/a	n/a	n/a	
Square Tables 	table top dimensions	seating capacity								
	36x36	4	n/a	n/a	n/a	n/a	n/a	n/a	n/a	n/a
	42x42	4	n/a	n/a	1 / 18	12	1 / 18	12	n/a	n/a
	48x48	4-8	4	7	1 / 24	12	1 / 18	15	n/a	n/a
	54x54	4-8	4	12	1 / 24	15	1 / 24	15	n/a	n/a
	60x60	8-12	4	12.5	1 / 30	16	1 / 24	18	n/a	n/a
	66x66	8-12	4	14	1 / 30	19	1 / 28	19	n/a	n/a
	72x72	12-16	5	15.5	1 / 36	18	1 / 28	22	n/a	n/a
84x84	12-16	6	18.5	1 / 42	21	1 / 42	21	n/a	n/a	
Modified Square Tables 	table top dimensions	seating capacity								
	36x36	4	n/a	n/a	n/a	n/a	n/a	n/a	n/a	n/a
	42x42	4	n/a	n/a	1 / 18	12	1 / 18	10.3	n/a	n/a
	48x48	4-8	4	5.1	1 / 24	12	1 / 18	13.1	n/a	n/a
	54x54	4-8	4	9.8	1 / 24	15	1 / 24	12.8	n/a	n/a
	60x60	8-12	4	12.1	1 / 30	16	1 / 24	15.6	n/a	n/a
	66x66	8-12	4	12.9	1 / 30	19	1 / 28	16.4	n/a	n/a
	72x72	12-16	5	12.6	1 / 36	18	1 / 28	19.1	n/a	n/a
84x84	12-16	6	15.1	1 / 42	21	1 / 42	17.6	n/a	n/a	
Elliptical Tables 	table top dimensions	seating capacity								
	36x72	6-8	4	15.5/6	n/a	n/a	n/a	n/a	2/24	17/3
	42x84	8-10	4	18.5/8	2/18	11.5/12	2/18	11.5/12	2/24	20/6
	48x84	8-10	4	18.5/9.5	2/18	12/15	2/18	12/15	2/24	20/9
	48x96	8-10	4	21.5/9.5	2/18	15/15	2/18	15/15	2/24	23/9

table & base compatibility chart

			Individual Legs		Cylinder		Cube		Panel	
			qty	knee space end/side	qty/dimen	knee space end/side	qty/dimen	knee space end/side	qty/dimen	knee space end/side
Rectangular Tables										
	table top dimensions	seating capacity								
	36x66	6	4	14/6.5	n/a	n/a	n/a	n/a	2 / 24	15.5/3
	36x72	6	4	15.5/6.5	n/a	n/a	n/a	n/a	2 / 24	17/3
	42x72	6-8	4	15.5/8	2 / 18	9/12	2 / 18	9/12	2 / 24	17/6
	42x84	8-10	4	18.5/8	2 / 18	12/12	2 / 18	12/12	2 / 24	20/6
	42x96	8-10	4	21.5/8	2 / 18	15/12	2 / 18	15/12	2 / 24	23/6
	48x84	8-10	4	18.5/9.5	2 / 18	12/15	2 / 18	12/15	2 / 24	20/9
	48x96	8-10	4	21.5/9.5	2 / 18	15/15	2 / 18	15/15	2 / 24	23/9
	48x108	12-12	6	21.5/9.5	2 / 18	18/15	2 / 18	18/15	2 / 24	23/9
	48x120	10-12	6	21.5/9.5	2 / 18	21/15	2 / 18	21/15	2 / 24	23/9
	48x144	12-14	6	21.5/9.5	3 / 18	15/15	3 / 18	15/15	3 / 24	23/9
	48x192	16-18	6	21.5/9.5	3 / 18	23/15	3 / 18	23/15	3 / 24	23/9
	54x108	10-12	6	21.5/11	2 / 24	15/15	2 / 24	15/15	2 / 27	23/9
	54x120	10-12	6	21.5/11	2 / 24	18/15	2 / 24	18/15	2 / 27	23/9
	54x144	12-14	6	21.5/11	3 / 24	12/15	3 / 24	12/15	3 / 27	23/9
	54x162	14-16	6	21.5/11	3 / 24	15/15	3 / 24	15/15	3 / 27	23/9
	54x168	14-16	6	21.5/11	3 / 24	16/15	3 / 24	16/15	3 / 27	23/9
	54x192	16-18	8	21.5/11	3 / 24	20/15	3 / 24	20/15	3 / 27	23/9
	54x216	18-20	8	21.5/11	3 / 24	24/15	3 / 24	24/15	3 / 27	23/9
	60x120	10-12	6	21.5/12.5	2 / 24	18/18	2 / 24	18/18	2 / 30	23/12
60x180	16-18	8	21.5/12.5	3 / 24	18/18	3 / 24	18/18	3 / 30	23/12	
60x240	18-20	8	21.5/12.5	3 / 24	24/18	3 / 24	24/18	3 / 30	23/12	
60x288	22-24	8	21.5/12.5	4 / 24	24/18	4 / 24	24/18	4 / 30	23/12	
Modified Rectangular Tables										
	table top dimensions	seating capacity								
	36x66	6	4	14/5.5	n/a	n/a	n/a	n/a	2 / 24	15.5/2
	36x72	6	4	15.5/5.4	n/a	n/a	n/a	n/a	2 / 24	17/1.9
	42x72	6-8	4	15.5/6.9	2 / 18	9/10.7	2 / 18	9/11.7	2 / 24	17/4.8
	42x84	8-10	4	18.5/6.8	2 / 18	12/10.6	2 / 18	12/11.5	2 / 24	20/4.6
	42x96	8-10	4	21.5/6.7	2 / 18	15/10.4	2 / 18	15/11.4	2 / 24	23/4.5
	48x84	8-10	4	18.5/8.2	2 / 18	12/13.5	2 / 18	12/14.5	2 / 24	20/7.6
	48x96	8-10	4	21.5/8.1	2 / 18	15/13.3	2 / 18	15/14.4	2 / 24	23/7.4
	48x108	12-12	6	21.5/7.5	2 / 18	18/13.2	2 / 18	18/14.2	2 / 24	23/6.8
	48x120	10-12	6	21.5/6.8	2 / 18	21/13	2 / 18	21/14	2 / 24	23/6.2
	48x144	12-14	6	21.5/6.8	3 / 18	15/12.3	3 / 18	15/11.1	3 / 24	23/6.3
	48x192	16-18	6	21.5/6.1	3 / 18	23/12.2	3 / 18	23/13	3 / 24	23/5.6
	54x108	10-12	6	21.5/8.8	2 / 24	15/13.1	2 / 24	15/14.4	2 / 27	23/6.8
	54x120	10-12	6	21.5/8.2	2 / 24	18/12.9	2 / 24	18/14.3	2 / 27	23/6.2
	54x144	12-14	6	21.5/7.4	3 / 24	12/10.7	3 / 24	12/12.6	3 / 27	23/4.9
	54x162	14-16	6	21.5/8.3	3 / 24	15/12	3 / 24	15/13.1	3 / 27	23/5.6
	54x168	14-16	6	21.5/8.3	3 / 24	16/12.8	3 / 24	16/13.5	3 / 27	23/6.3
	54x192	16-18	8	21.5/7.6	3 / 24	20/12.1	3 / 24	20/13.2	3 / 27	23/5.6
	54x216	18-20	8	21.5/6.9	3 / 24	24/12	3 / 24	24/12.9	3 / 27	23/4.9
	60x120	10-12	6	21.5/9.7	2 / 24	18/16	2 / 24	18/17.3	2 / 30	23/9.2
60x180	16-18	8	21.5/9.4	3 / 24	18/15.4	3 / 24	18/16.4	3 / 30	23/6.9	
60x240	18-20	8	21.5/7.7	3 / 24	24/14.3	3 / 24	24/15.3	3 / 30	23/7.2	
60x288	22-24	8	21.5/6.2	4 / 24	24/12.8	4 / 24	24/13.9	4 / 30	23/5.7	

table & base compatibility chart

Continuous		Column End		Four Column	
					
dimen	knee space end/side	dimen	knee space end/side	qty/dimen	knee space end/side
18x44	11/9	2/24	15/17	n/a	n/a
18x44	14/9	2/24	17/17	n/a	n/a
18x44	14/12	2/30	17/20	n/a	n/a
18x52	16/12	2/30	20/20	n/a	n/a
18x60	18/12	3/30	15/20	n/a	n/a
18x52	16/15	2/36	20/23	n/a	n/a
18x60	18/15	2/36	23/13	2 / 27	17.5/17.5
18x72	18/15	3/36	17/23	2 / 27	20.5/17.5
18x84	18/15	3/36	19/23	2 / 27	23.5/17.5
18x102	21/15	3/36	23/23	3 / 27	17.5/17.5
18x150	21/15	4/36	24/23	3 / 27	23.5/17.5
24x72	18/15	*3/42	17/13	2 / 29	20.5/20.5
24x84	18/15	*3/42	19/13	2 / 29	23.5/20.5
24x102	21/15	*3/42	23/13	3 / 29	20/20.5
24x120	21/15	*3/42	23/13	3 / 29	20.5/20.5
24x126	21/15	*3/42	23/13	3 / 29	21.5/20.5
24x150	21/15	*3/42	23/13	3 / 29	23.5/20.5
24x174	21/15	*4/42	23/13	3 / 29	23.5/20.5
24x84	18/18	n/a	n/a	2 / 32	23.5/23.5
24x138	21/18	n/a	n/a	3 / 32	23.5/23.5
24x198	21/18	n/a	n/a	3 / 32	23.5/23.5
24x246	21/18	n/a	n/a	4 / 32	23.5/23.5
18x44	11/9	2/24	15/17	n/a	n/a
18x44	14/9	2/24	17/17	n/a	n/a
18x44	14/12	2/30	17/20	n/a	n/a
18x52	16/12	2/30	20/20	n/a	n/a
18x60	18/12	3/30	15/20	n/a	n/a
18x52	16/15	2/36	20/23	n/a	n/a
18x60	18/15	2/36	23/11.4	2 / 27	17.5/14.9
18x72	18/15	3/36	17/23	2 / 27	20.5/14.9
18x84	18/15	3/36	19/23	2 / 27	23.5/14.7
18x102	21/15	3/36	23/23	3 / 27	17.5/14.1
18x150	21/15	4/36	24/23	3 / 27	23.5/14.2
24x72	18/15	*3/42	17/9.8	2 / 29	20.5/17.8
24x84	18/15	*3/42	19/9.5	2 / 29	23.5/17.7
24x102	21/15	*3/42	23/8.8	3 / 29	20/17.8
24x120	21/15	*3/42	23/9.6	3 / 29	20.5/16.7
24x126	21/15	*3/42	23/10.3	3 / 29	21.5/17.7
24x150	21/15	*3/42	23/9.6	3 / 29	23.5/17.1
24x174	21/15	*4/42	23/8.9	3 / 29	23.5/16
24x84	18/18	n/a	n/a	2 / 32	23.5/20.6
24x138	21/18	n/a	n/a	3 / 32	23.5/20.5
24x198	21/18	n/a	n/a	3 / 32	23.5/19
24x246	21/18	n/a	n/a	4 / 32	23.5/17.2

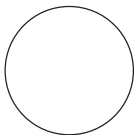
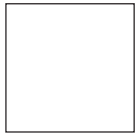
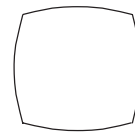
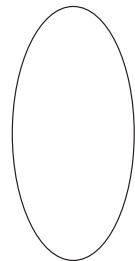
* (double column end)

table & base compatibility chart

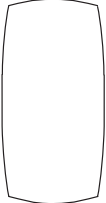
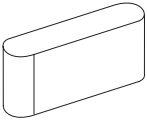
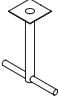
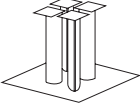

			Individual Legs		Cylinder		Cube		Panel	
			qty	knee space end/side	qty/dimen	knee space end/side	qty/dimen	knee space end/side	qty/dimen	knee space end/side
Racetrack Tables										
	table top dimensions	seating capacity								
	36x66	6	4	14/6.5	n/a	n/a	n/a	n/a	2/24	15.5/3
	36x72	6	4	15.5/6.5	n/a	n/a	n/a	n/a	2/24	17/3
	42x72	6-8	4	15.5/8	2/18	9/12	2/18	9/12	2/24	17/6
	42x84	8-10	4	18.5/8	2/18	12/12	2/18	12/12	2/24	20/6
	42x96	8-10	4	21.5/8	2/18	15/12	2/18	15/12	2/24	23/6
	48x84	8-10	4	18.5/9.5	2/18	12/15	2/18	12/15	2/24	20/9
	48x96	8-10	4	21.5/9.5	2/18	15/15	2/18	15/15	2/24	23/9
	48x108	12-12	6	21.5/9.5	2/18	18/15	2/18	18/15	2/24	23/9
	48x120	10-12	6	21.5/9.5	2/18	21/15	2/18	21/15	2/24	23/9
	48x144	12-14	6	21.5/9.5	3/18	15/15	3/18	15/15	3/24	23/9
	48x192	16-18	6	21.5/9.5	3/18	23/15	3/18	23/15	3/24	23/9
	54x108	10-12	6	21.5/11	2/24	15/15	2/24	15/15	2/27	23/9
	54x120	10-12	6	21.5/11	2/24	18/15	2/24	18/15	2/27	23/9
	54x144	12-14	6	21.5/11	3/24	12/15	3/24	12/15	3/27	23/9
	54x162	14-16	6	21.5/11	3/24	15/15	3/24	15/15	3/27	23/9
	54x168	14-16	6	21.5/11	3/24	16/15	3/24	16/15	3/27	23/9
	54x192	16-18	8	21.5/11	3/24	20/15	3/24	20/15	3/27	23/9
	54x216	18-20	8	21.5/11	3/24	24/15	3/24	24/15	3/27	23/9
	60x120	10-12	6	21.5/12.5	2/24	18/18	2/24	18/18	2/30	23/12
60x180	16-18	8	21.5/12.5	3/24	18/18	3/24	18/18	3/30	23/12	
60x240	18-20	8	21.5/12.5	3/24	24/18	3/24	24/18	3/30	23/12	
60x288	22-24	8	21.5/12.5	4/24	24/18	4/24	24/18	4/30	23/12	
Boat Tables										
	table top dimensions	seating capacity								
	36x66	6	4	14/5.5	n/a	n/a	n/a	n/a	2/24	15.5/2
	36x72	6	4	15.5/5.4	n/a	n/a	n/a	n/a	2/24	17/1.9
	42x72	6-8	4	15.5/6.9	2/18	9/10.7	2/18	9/11.7	2/24	17/4.8
	42x84	8-10	4	18.5/6.8	2/18	12/10.6	2/18	12/11.5	2/24	20/4.6
	42x96	8-10	4	21.5/6.7	2/18	15/10.4	2/18	15/11.4	2/24	23/4.5
	48x84	8-10	4	18.5/8.2	2/18	12/13.5	2/18	12/14.5	2/24	20/7.6
	48x96	8-10	4	21.5/8.1	2/18	15/13.3	2/18	15/14.4	2/24	23/7.4
	48x108	12-12	6	21.5/7.5	2/18	18/13.2	2/18	18/14.2	2/24	23/6.8
	48x120	10-12	6	21.5/6.8	2/18	21/13	2/18	21/14	2/24	23/6.2
	48x144	12-14	6	21.5/6.8	3/18	15/12.3	3/18	15/11.1	2/24	23/6.3
	48x192	16-18	6	21.5/6.1	3/18	23/12.2	3/18	23/13	3/24	23/5.6
	54x108	10-12	6	21.5/8.8	2/24	15/13.1	2/24	15/14.4	2/27	23/6.8
	54x120	10-12	6	21.5/8.2	2/24	18/12.9	2/24	18/14.3	2/27	23/6.2
	54x144	12-14	6	21.5/7.4	3/24	12/10.7	3/24	12/12.6	3/27	23/4.9
	54x162	14-16	6	21.5/8.3	3/24	15/12	3/24	15/13.1	3/27	23/5.6
	54x168	14-16	6	21.5/8.3	3/24	16/12.8	3/24	16/13.5	3/27	23/6.3
	54x192	16-18	8	21.5/7.6	3/24	20/12.1	3/24	20/13.2	3/27	23/5.6
	54x216	18-20	8	21.5/6.9	3/24	24/12	3/24	24/12.9	3/27	23/4.9
	60x120	10-12	6	21.5/9.7	2/24	18/16	2/24	18/17.3	2/30	23/9.2
60x180	16-18	8	21.5/9.4	3/24	18/15.4	3/24	18/16.4	3/30	23/6.9	
60x240	18-20	8	21.5/7.7	3/24	24/14.3	3/24	24/15.3	3/30	23/7.2	
60x288	22-24	8	21.5/6.2	4/24	24/12.8	4/24	24/13.9	4/30	23/5.7	

table & base compatibility chart

Continuous		Column End		Four Column	
					
dimen	knee space end/side	dimen	knee space end/side	qty/dimen	knee space end/side
18x44	11/9	2/24	15/17	n/a	n/a
18x44	14/9	2/24	17/17	n/a	n/a
18x44	14/12	2/30	17/20	n/a	n/a
18x52	16/12	2/30	20/20	n/a	n/a
18x60	18/12	3/30	15/20	n/a	n/a
18x52	16/15	2/36	20/23	n/a	n/a
18x60	18/15	*2/36	23/13	2/27	17.5/17.5
18x72	18/15	3/36	17/23	2/27	20.5/17.5
18x84	18/15	3/36	19/23	2/27	23.5/17.5
18x102	21/15	3/36	23/23	3/27	17.5/17.5
18x150	21/15	4/36	24/23	3/27	23.5/17.5
24x72	18/15	*3/42	17/13	2/29	20.5/20.5
24x84	18/15	*3/42	19/13	2/29	23.5/20.5
24x102	21/15	*3/42	23/13	3/29	20/20.5
24x120	21/15	*3/42	23/13	3/29	20.5/20.5
24x126	21/15	*3/42	23/13	3/29	21.5/20.5
24x150	21/15	*3/42	23/13	3/29	23.5/20.5
24x174	21/15	*4/42	23/13	3/29	23.5/20.5
24x84	18/18	n/a	n/a	2/32	23.5/23.5
24x138	21/18	n/a	n/a	3/32	23.5/23.5
24x198	21/18	n/a	n/a	3/32	23.5/23.5
24x246	21/18	n/a	n/a	4/32	23.5/23.5
18x44	11/9	2/24	15/17	n/a	n/a
18x44	14/9	2/24	17/17	n/a	n/a
18x44	14/12	2/30	17/20	n/a	n/a
18x52	16/12	2/30	20/20	n/a	n/a
18x60	18/12	3/30	15/20	n/a	n/a
18x52	16/15	2/36	20/23	n/a	n/a
18x60	18/15	*2/36	23/11.4	2/27	17.5/14.9
18x72	18/15	3/36	17/23	2/27	20.5/14.9
18x84	18/15	3/36	19/23	2/27	23.5/14.7
18x102	21/15	3/36	23/23	3/27	17.5/14.1
18x150	21/15	4/36	24/23	3/27	23.5/14.2
24x72	18/15	*3/42	17/9.8	2/29	20.5/17.8
24x84	18/15	*3/42	19/9.5	2/29	23.5/17.7
24x102	21/15	*3/42	23/8.8	3/29	20/17.8
24x120	21/15	*3/42	23/9.6	3/29	20.5/16.7
24x126	21/15	*3/42	23/10.3	3/29	21.5/17.7
24x150	21/15	*3/42	23/9.6	3/29	23.5/17.1
24x174	21/15	*4/42	23/8.9	3/29	23.5/16
24x84	18/18	n/a	n/a	2/32	23.5/20.6
24x138	21/18	n/a	n/a	3/32	23.5/20.5
24x198	21/18	n/a	n/a	3/32	23.5/19
24x246	21/18	n/a	n/a	4/32	23.5/17.2

* (double column end)

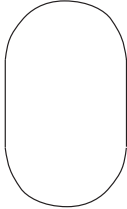
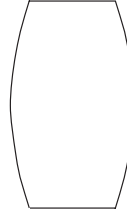
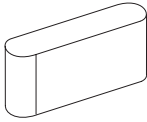
conference tables – table tops

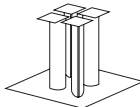
ZCTO

Round Table Top

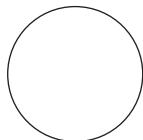

WHAT'S INCLUDED

Table tops in widths from 36" - 60" will be 1 piece.

Table tops in widths from 66" - 108" will be 2 pieces.

NOTES

Table base requirements, knee space and seating capacity details can be found on page 34.

Please see finish listing with codes in the Wood / Casegoods Introduction Booklet.

PRODUCT OPTIONS

Diameter		Finish	Edge Detail (See illustrations and codes on page 30)	Grain Design (See illustrations and codes on page 32)
036 36	066 66	Natural Veneer	Grade 1	Standard Grain
042 42	072 72	Custom Wood Stain	Grade 2	Patterned Grain
048 48	084 84		Grade 3	
054 54	096 96		Grade 4	
060 60	100 108			

SAMPLE ORDER CODE

ZCTO 036	UH	EA	T1
-----------------	-----------	-----------	-----------

DIMENSIONS INCHES / MM

Dia.
36 / 914
42 / 1067
48 / 1219
54 / 1372
60 / 1524
66 / 1676
72 / 1829
84 / 2134
96 / 2438
100 / 2540

PRICING

	Grade 1 Edge	Grade 2 Edge	Grade 3 Edge	Grade 4 Edge
STANDARD GRAIN DESIGN				
2417	2779	3212	3847	
2610	3000	3454	4148	
3131	3330	3999	4761	
4272	4558	4956	5962	
4674	4978	5401	6537	
7648	8633	9558	10786	
8891	9971	10788	12228	
11904	12747	14215	15798	
14202	15237	16846	18649	
17503	18772	20468	22505	
PATTERNED GRAIN DESIGN				
2979	3341	3773	4408	
3376	3765	4220	4914	
4133	4333	5001	5763	
5534	5820	6218	7224	
6233	6537	6960	8096	
9541	10526	11452	12679	
11143	12223	13040	14479	
14965	15808	17276	18859	
18197	19232	20841	22644	
22565	23835	25530	27567	

To order a Custom Color for Conference Tables please use the code ZCCWS. A one time 1267 list charge per color applies.

ZCTQ

Square Table Top

WHAT'S INCLUDED

Table tops in widths from 36" - 60" will be 1 piece.

Table tops in widths from 66" - 84" will be 2 pieces.

NOTES

Table base requirements, knee space and seating capacity details can be found on page 34.

Please see finish listing with codes in the Wood / Casegoods Introduction Booklet.

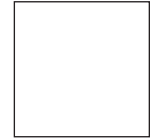

PRODUCT OPTIONS

Diameter		Finish	Edge Detail (See illustrations and codes on page 30)	Grain Design (See illustrations and codes on page 32)	Corner Detail (See illustrations on page 31)
036 36	066 66	Natural Veneer	Grade 1	Standard Grain	N Default Corner Detail
042 42	072 72	Custom Wood Stain	Grade 2	Patterned Grain	C2 With 2" Inside Radius Top Corner Detail C4 With 4" Inside Radius Top Corner Detail
048 48	084 84		Grade 3		
054 54			Grade 4		
060 60					

SAMPLE ORDER CODE

ZCTQ 036	UH	EA	T1	N
-----------------	-----------	-----------	-----------	----------

**DIMENSIONS
INCHES / MM**

Dia.
36 / 914
42 / 1067
48 / 1219
54 / 1372
60 / 1524
66 / 1676
72 / 1829
84 / 2134

PRICING

	Grade 1 Edge	Grade 2 Edge	Grade 3 Edge	Grade 4 Edge
STANDARD GRAIN DESIGN				
36 / 914	1864	2391	2404	3158
42 / 1067	1926	2395	2620	3630
48 / 1219	2472	2959	3271	4313
54 / 1372	2841	3061	3599	4729
60 / 1524	3663	4248	4476	5860
66 / 1676	5954	6444	6928	9190
72 / 1829	7258	7806	8342	10802
84 / 2134	10126	10760	11385	14258
PATTERNED GRAIN DESIGN				
36 / 914	2426	2952	2965	3719
42 / 1067	2691	3161	3386	4395
48 / 1219	3474	3961	4273	5315
54 / 1372	4103	4323	4862	5991
60 / 1524	5222	5807	6035	7419
66 / 1676	7847	8337	8821	11083
72 / 1829	9510	10057	10593	13053
84 / 2134	13187	13821	14447	17319

If either of the C2 or C4 Corner Details are specified, add 935

To order a Custom Color for Conference Tables please use the code ZCCWS. A one time 1267 list charge per color applies.

conference tables – table tops

ZCTMQ

Modified Square Table Top

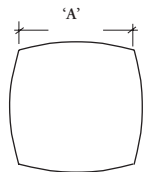

WHAT'S INCLUDED

Table tops in widths from 36" - 60" will be 1 piece.

Table tops in widths from 66" - 84" will be 2 pieces.

NOTES

Table base requirements, knee space and seating capacity details can be found on page 34.

Please see finish listing with codes in the Wood / Casegoods Introduction Booklet.

PRODUCT OPTIONS

Diameter		Finish	Edge Detail (See illustrations and codes on page 30)	Grain Design (See illustrations and codes on page 32)
036 36	066 66	Natural Veneer	Grade 1	Standard Grain
042 42	072 72	Custom Wood Stain	Grade 2	Patterned Grain
048 48	084 84		Grade 3	
054 54			Grade 4	
060 60				

SAMPLE ORDER CODE

ZCTMQ 036	UH	EA	T1
------------------	-----------	-----------	-----------

DIMENSIONS INCHES / MM

Dia.
36 / 914
42 / 1067
48 / 1219
54 / 1372
60 / 1524
66 / 1676
72 / 1829
84 / 2134
36 / 914
42 / 1067
48 / 1219
54 / 1372
60 / 1524
66 / 1676
72 / 1829
84 / 2134

PRICING

	Grade 1 Edge	Grade 2 Edge	Grade 3 Edge	Grade 4 Edge
STANDARD GRAIN DESIGN				
2417	2779	3212	3847	
2610	3000	3454	4148	
3131	3330	3999	4761	
4272	4558	4956	5962	
4674	4978	5401	6537	
7648	8633	9558	10786	
8891	9971	10788	12228	
11904	12747	14215	15798	
PATTERNED GRAIN DESIGN				
2979	3341	3773	4408	
3376	3765	4220	4914	
4133	4333	5001	5763	
5534	5820	6218	7224	
6233	6537	6960	8096	
9541	10526	11452	12679	
11143	12223	13040	14479	
14965	15808	17276	18859	

OTHER DIMENSION

'A'
30
35
40
45
50
55
60
69
30
35
40
45
50
55
60
69

To order a Custom Color for Conference Tables please use the code ZCCWS. A one time 1267 list charge per color applies.

NOTES

All sizes will be 1 piece.

Table base requirements, knee space and seating capacity details can be found on page 34.

Please see finish listing with codes in the Wood / Casegoods Introduction Booklet.

ZCTEL Elliptical Table Top

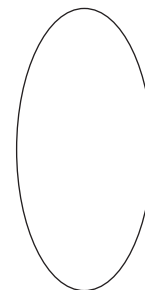

PRODUCT OPTIONS

Depth	Width	Finish	Edge Detail (See illustrations and codes on page 30)	Grain Design (See illustrations and codes on page 32)
36, 42, 48	072 72	Natural Veneer	Grade 1	Standard Grain
	084 84	Custom Wood Stain	Grade 2	Patterned Grain
	096 96		Grade 3	
		Grade 4		

SAMPLE ORDER CODE

ZCTEL 36	072	UH	EA	T1
-----------------	------------	-----------	-----------	-----------

DIMENSIONS INCHES / MM

D	W
36 / 914	72 / 1829
42 / 1067	84 / 2134
48 / 1219	84 / 2134
48 / 1219	96 / 2438

PRICING

	Grade 1 Edge	Grade 2 Edge	Grade 3 Edge	Grade 4 Edge
STANDARD GRAIN DESIGN				
	4978	5691	6350	7610
	6562	7047	7772	9283
	6908	7407	8164	9677
	7588	8115	8909	10424
PATTERNED GRAIN DESIGN				
	6240	6953	7612	8872
	8098	8583	9308	10819
	8657	9156	9913	11426
	9585	10113	10906	12421

To order a Custom Color for Conference Tables please use the code ZCCWS. A one time 1267 list charge per color applies.

Z C T R

Rectangular Table Top (Continued)

DIMENSIONS INCHES / MM		PRICING				NUMBER OF PIECES
		PATTERNED GRAIN DESIGN				
D	W	Grade 1 Edge	Grade 2 Edge	Grade 3 Edge	Grade 4 Edge	
36 / 914	66 / 1676	4486	4877	5264	6562	1
36 / 914	72 / 1829	4582	4993	5408	6779	1
42 / 1067	72 / 1829	5310	5852	6167	7649	1
42 / 1067	84 / 2134	6067	6537	7005	8644	1
42 / 1067	96 / 2438	6902	7417	7939	9735	1
48 / 1219	84 / 2134	7180	7694	8216	10008	1
48 / 1219	96 / 2438	7724	8267	8803	10679	1
48 / 1219	108 / 2743	8661	8741	10347	12067	2
48 / 1219	120 / 3048	9203	9837	11856	12652	2
48 / 1219	144 / 3658	12211	12943	13680	14594	2
48 / 1219	192 / 4877	16285	17200	18118	21170	2
54 / 1372	108 / 2743	10330	10959	11590	13806	2
54 / 1372	120 / 3048	11449	12114	12780	14994	2
54 / 1372	144 / 3658	13801	14536	15283	17862	2
54 / 1372	162 / 4115	15462	16230	17774	21644	2
54 / 1372	168 / 4267	16362	17197	18025	20915	2
54 / 1372	192 / 4877	18298	19214	20140	23347	2
54 / 1372	216 / 5486	20610	21641	23700	28849	3
60 / 1524	120 / 3048	12723	13408	14783	18445	2
60 / 1524	180 / 4572	19084	19768	21142	23700	3
60 / 1524	240 / 6096	n/a	n/a	n/a	n/a	3
60 / 1524	288 / 7315	n/a	n/a	n/a	n/a	3

If either of the C2 or C4 Corner Details are specified, add 935

To order a Custom Color for Conference Tables please use the code ZCCWS. A one time 1267 list charge per color applies.

conference tables – table tops

ZCTMR

Modified Rectangular Table Top

NOTES

Table base requirements, knee space and seating capacity details can be found on page 34.

Please see finish listing with codes in the Wood / Casegoods Introduction Booklet.

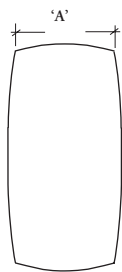

PRODUCT OPTIONS

Depth	Diameter				Finish	Edge Detail (See illustrations and codes on page 30)	Grain Design (See illustrations and codes on page 32)	Corner Detail (See illustrations on page 31)	
36, 42, 48, 54, 60	066	66	144	144	240	240	Natural Veneer Grade 1 Grade 2 Grade 3 Grade 4	Standard Grain Patterned Grain	N Default Corner Detail C2 With 2" Inside Radius Top Corner Detail C4 With 4" Inside Radius Top Corner Detail
	072	72	162	162	280	280			
	084	84	168	168					
	096	96	180	180					
	108	108	192	192					
	120	120	216	216					

SAMPLE ORDER CODE

ZCTMR 36	066	UH	EA	T1	N
----------	-----	----	----	----	---

DIMENSIONS INCHES / MM

D	W
36 / 914	66 / 1676
36 / 914	72 / 1829
42 / 1067	72 / 1829
42 / 1067	84 / 2134
42 / 1067	96 / 2438
48 / 1219	84 / 2134
48 / 1219	96 / 2438
48 / 1219	108 / 2743
48 / 1219	120 / 3048
48 / 1219	144 / 3658
48 / 1219	192 / 4877
54 / 1372	108 / 2743
54 / 1372	120 / 3048
54 / 1372	144 / 3658
54 / 1372	162 / 4115
54 / 1372	168 / 4267
54 / 1372	192 / 4877
54 / 1372	216 / 5486
60 / 1524	120 / 3048
60 / 1524	180 / 4572
60 / 1524	240 / 6096
60 / 1524	288 / 7315

PRICING

STANDARD GRAIN DESIGN			
Grade 1 Edge	Grade 2 Edge	Grade 3 Edge	Grade 4 Edge
4450	4704	4915	5708
4853	5132	5358	6230
7770	8195	8623	10107
8337	8806	9278	10918
8697	9209	9731	11523
9002	9513	10036	11830
9629	10170	10709	12583
10194	11042	11882	13601
10680	11309	11936	14129
12948	13678	14289	16610
17264	18241	19053	22148
11748	12373	13005	15196
12136	12823	13396	15574
14702	15436	16182	18758
16387	17315	18090	21024
16772	17605	18436	21324
18212	19131	20054	23261
21849	23083	24116	28033
13485	14249	14885	17301
20229	21376	22329	25952
22893	24014	25149	29230
28760	30068	31365	35818

OTHER DIMENSION

'A'	NUMBER OF PIECES
29	1
28	1
35	1
33	1
31	1
39	1
38	1
36	2
34	2
37	2
37	2
42	2
41	2
37	2
42	2
45	2
43	2
42	3
47	2
50	3
46	3
43	3

If either of the C2 or C4 Corner Details are specified, add 935

To order a Custom Color for Conference Tables please use the code ZCCWS. A one time 1267 list charge per color applies.

Z C T M R

**Modified Rectangular Table Top
(Continued)**

DIMENSIONS INCHES / MM		PRICING				OTHER DIMENSION	NUMBER OF PIECES
		PATTERNED GRAIN DESIGN					
D	W	Grade 1 Edge	Grade 2 Edge	Grade 3 Edge	Grade 4 Edge	'A'	
36 / 914	66 / 1676	5501	5755	5966	6759	29	1
36 / 914	72 / 1829	5998	6277	6503	7375	28	1
42 / 1067	72 / 1829	9085	9511	9939	11423	35	1
42 / 1067	84 / 2134	9873	10341	10814	12454	33	1
42 / 1067	96 / 2438	10446	10959	11481	13273	31	1
48 / 1219	84 / 2134	10751	11262	11786	13579	39	1
48 / 1219	96 / 2438	11627	12167	12707	14580	38	1
48 / 1219	108 / 2743	12442	13290	14130	15849	36	2
48 / 1219	120 / 3048	13180	13809	14436	16629	34	2
48 / 1219	144 / 3658	16000	16730	17341	19662	37	2
48 / 1219	192 / 4877	21335	22311	23123	26218	37	2
54 / 1372	108 / 2743	14248	14872	15505	17696	42	2
54 / 1372	120 / 3048	14999	15686	16259	18437	41	2
54 / 1372	144 / 3658	18076	18811	19556	22133	37	2
54 / 1372	162 / 4115	20251	21179	21954	24888	42	2
54 / 1372	168 / 4267	20707	21540	22371	25259	45	2
54 / 1372	192 / 4877	22714	23633	24556	27763	43	2
54 / 1372	216 / 5486	26998	28232	29266	33182	42	3
60 / 1524	120 / 3048	16665	17429	18065	20481	47	2
60 / 1524	180 / 4572	24999	26146	27099	30721	50	3
60 / 1524	240 / 6096	n/a	n/a	n/a	n/a	46	3
60 / 1524	288 / 7315	n/a	n/a	n/a	n/a	43	3

If either of the C2 or C4 Corner ls are specified, add 935

To order a Custom Color for Conference Tables please use the code ZCCWS. A one time 1267 list charge per color applies.

Z C T T

Racetrack Table Top (Continued)

DIMENSIONS INCHES / MM		PRICING				OTHER DIMENSION	NUMBER OF PIECES
		PATTERNED GRAIN DESIGN					
D	W	Grade 1 Edge	Grade 2 Edge	Grade 3 Edge	Grade 4 Edge	'A'	
36 / 914	66 / 1676	5323	5686	6048	7687	30	1
36 / 914	72 / 1829	5980	6389	6791	8636	30	1
42 / 1067	72 / 1829	7427	8120	8810	10116	36	1
42 / 1067	84 / 2134	8221	8953	9692	11206	36	1
42 / 1067	96 / 2438	9096	9876	10653	12377	36	1
48 / 1219	84 / 2134	9109	9895	10671	12410	40	1
48 / 1219	96 / 2438	9971	10816	11657	13376	40	1
48 / 1219	108 / 2743	10831	11679	12520	14239	40	2
48 / 1219	120 / 3048	11523	12460	13376	15517	40	2
48 / 1219	144 / 3658	13993	15216	15949	18387	40	2
48 / 1219	192 / 4877	18655	20285	21263	24517	40	2
54 / 1372	108 / 2743	13476	14410	15335	17472	44	2
54 / 1372	120 / 3048	14404	15522	16638	19167	44	2
54 / 1372	144 / 3658	16289	17410	18521	21054	44	2
54 / 1372	162 / 4115	17707	19255	20182	23274	44	2
54 / 1372	168 / 4267	18927	20143	21349	24267	44	2
54 / 1372	192 / 4877	20935	22231	23527	26874	44	2
54 / 1372	216 / 5486	23613	25672	26911	31032	44	3
60 / 1524	120 / 3048	14580	15846	16611	19156	48	2
60 / 1524	180 / 4572	21861	23768	24914	28732	48	3
60 / 1524	240 / 6096	n/a	n/a	n/a	n/a	48	3
60 / 1524	288 / 7315	n/a	n/a	n/a	n/a	48	3

To order a Custom Color for Conference Tables please use the code ZCCWS. A one time 1267 list charge per color applies.

Z C T B

Boat Table Top (Continued)

DIMENSIONS INCHES / MM		PRICING				NUMBER OF PIECES
		PATTERNED GRAIN DESIGN				
D	W	Grade 1 Edge	Grade 2 Edge	Grade 3 Edge	Grade 4 Edge	
36 / 914	66 / 1676	6554	7097	7641	8651	1
36 / 914	72 / 1829	7147	7743	8337	9433	1
42 / 1067	72 / 1829	8324	9012	9705	11008	1
42 / 1067	84 / 2134	9109	9847	10578	12095	1
42 / 1067	96 / 2438	9986	10765	11543	13267	1
48 / 1219	84 / 2134	9477	10263	11047	12471	1
48 / 1219	96 / 2438	10861	11708	12548	14271	1
48 / 1219	108 / 2743	12182	13193	14200	16035	2
48 / 1219	120 / 3048	12417	13352	14277	16413	2
48 / 1219	144 / 3658	16242	17589	18930	21368	2
48 / 1219	192 / 4877	21660	23449	25242	28499	2
54 / 1372	108 / 2743	12405	13230	14052	16011	2
54 / 1372	120 / 3048	14317	15228	16145	18323	2
54 / 1372	144 / 3658	17183	18305	19421	21950	2
54 / 1372	162 / 4115	19320	20556	21789	24725	2
54 / 1372	168 / 4267	19815	21035	22237	25159	2
54 / 1372	192 / 4877	22901	24373	25837	29317	2
54 / 1372	216 / 5486	25759	27407	29057	32974	3
60 / 1524	120 / 3048	16923	18316	19720	22263	2
60 / 1524	180 / 4572	25380	26719	29581	33396	3
60 / 1524	240 / 6096	n/a	n/a	n/a	n/a	3
60 / 1524	288 / 7315	n/a	n/a	n/a	n/a	3

If either of the C2 or C4 Corner Details are specified, add 935

To order a Custom Color for Conference Tables please use the code ZCCWS. A one time 1267 list charge per color applies.

Z T B O L

Round Leg with Metal Base

WHAT'S INCLUDED

1 leg with attachment hardware.

NOTES

Table base requirements, knee space and seating capacity details can be found on page 34.

Please see finish listing with codes in the Wood / Casegoods Introduction Booklet.

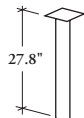

PRODUCT OPTIONS

Diameter	Finish
3, 4, 5	60 Platinum 52 Ebony C9 Polished Chrome

SAMPLE ORDER CODE

ZTBOL 3	60
---------	----

DIMENSIONS INCHES / MM

Dia.
3 / 76
4 / 102
5 / 127

PRICING

458
682
918

Z T B O L C

Mobile Round Leg with Metal Base

WHAT'S INCLUDED

1 leg with attachment hardware.

NOTES

Non-locking casters are partially concealed with bottom of leg 1/2" from the floor.

Locking casters will be fully exposed.

Table base requirements, knee space and seating capacity details can be found on page 34.

Please see finish listing with codes in the Wood / Casegoods Introduction Booklet.

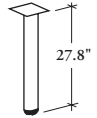

PRODUCT OPTIONS

Diameter	Caster Option	Finish
4, 5	N Non-Locking Caster L Locking Caster	60 Platinum 52 Ebony

SAMPLE ORDER CODE

ZTBOLC 4	N	60
-----------------	----------	-----------

**DIMENSIONS
INCHES / MM**

Dia.
4 / 102
5 / 127

PRICING

Non-Locking Caster	Locking Caster
811	899
1063	1152

conference tables – table bases

Z T B 2 0 Panel Base

WHAT'S INCLUDED

1 panel base with attachment hardware and stretcher rails as required.

NOTES

Table base requirements, knee space and seating capacity details can be found on page 34.

Please see finish listing with codes in the Wood / Casegoods Introduction Booklet.

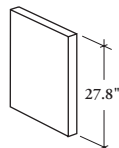

PRODUCT OPTIONS

Width	Finish
24, 27, 30	60 Platinum 74 Storm White Natural Veneer Custom Wood Stain

SAMPLE ORDER CODE

ZTB20 24	60
----------	----

DIMENSIONS INCHES / MM

W
24 / 610
27 / 686
30 / 762

PRICING

777
821
980

To order a Custom Color for Conference Tables please use the code ZCCWS. A one time 1267 list charge per color applies.

WHAT'S INCLUDED

1 base with attachment hardware.

NOTES

The 18" and 24" base **cannot** be used with an intercept unit.

Table base requirements, knee space and seating capacity details can be found on page 34.

Please see finish listing with codes in the Wood / Caseworks Introduction Booklet.

Z T B 2 1

Cylinder Base

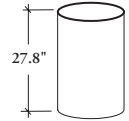

PRODUCT OPTIONS

Diameter	10" x 10" Access Panel Option	Finish
18, 24, 30, 36, 42, 48	N No Access Panel A With Access Panel	60 Platinum (Painted MDF) 74 Storm White (Painted MDF) Natural Veneer Custom Wood Stain

SAMPLE ORDER CODE

ZTB21 18	N	60
-----------------	----------	-----------

**DIMENSIONS
INCHES / MM**

Dia.
18 / 457
24 / 610
30 / 762
36 / 914
42 / 1067
48 / 1219

PRICING

	No Access Panel	With Access Panel
18	2089	3359
24	2231	3502
30	2504	3777
36	3047	4320
42	4793	6068
48	5124	6395

To order a Custom Color for Conference Tables please use the code ZCCWS. A one time 1267 list charge per color applies.

conference tables – table bases

Z T B 2 2 Cube Base

WHAT'S INCLUDED

1 base with attachment hardware.

NOTES

Table base requirements, knee space and seating capacity details can be found on page 34.

Please see finish listing with codes in the Wood / Casegoods Introduction Booklet.

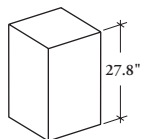

PRODUCT OPTIONS

Diameter	10" x 10" Access Panel Option	Finish
18, 24, 28, 42	N No Access Panel A With Access Panel	60 Platinum (Painted MDF) 74 Storm White (Painted MDF) Natural Veneer Custom Wood Stain

SAMPLE ORDER CODE

ZTB22 18	N	60
-----------------	----------	-----------

DIMENSIONS INCHES / MM

Dia.
18 / 457
24 / 610
28 / 711
42 / 1067

PRICING

	No Access Panel	With Access Panel
	2391	3661
	2535	3805
	3046	4319
	4565	5835

To order a Custom Color for Conference Tables please use the code ZCCWS. A one time 1267 list charge per color applies.

Z T B 4 4

Metal Column End Base

WHAT'S INCLUDED

1 base with attachment hardware.

NOTES

This base is not available for tables over 48" in diameter.

Column is 2" in diameter,

Table base requirements, knee space and seating capacity details can be found on page 34.

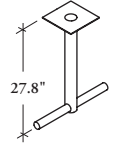

PRODUCT OPTIONS

Depth	Finish
26 24	60 Platinum
36 36	52 Ebony
	C9 Polished Chrome

SAMPLE ORDER CODE

ZTB44 26	60
----------	----

**DIMENSIONS
INCHES / MM**

D
26 / 660
36 / 914

PRICING

521
688

Z T B 4 3 Metal Column X Base

WHAT'S INCLUDED
1 base with attachment hardware.

NOTES
This base is not available for tables over 48" in diameter.
Column is 2 3/4" in diameter.

Table base requirements, knee space and seating capacity details can be found on page 34.

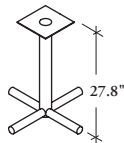

PRODUCT OPTIONS

Depth/Width	Finish
30, 36	60 Platinum 52 Ebony C9 Polished Chrome

SAMPLE ORDER CODE

ZTB43 30	60
----------	----

DIMENSIONS INCHES / MM

D/W
30 / 762
36 / 914

PRICING

880
1002

Z T B 4 9

Double Metal Column End Base

WHAT'S INCLUDED

1 base with attachment hardware.

NOTES

This base is for use with 48" d x 96"w and all 54"d table tops.

Both columns are 2" in diameter.

Table base requirements, knee space and seating capacity details can be found on page 34.

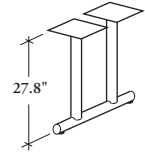

PRODUCT OPTIONS

Depth	Finish
36, 42	60 Platinum 52 Ebony C9 Polished Chrome

SAMPLE ORDER CODE

ZTB49 36	60
-----------------	-----------

**DIMENSIONS
INCHES / MM**

D
36 / 914
42 / 1067

PRICING

730
878

ZAGSH

Shadow Spider Box



Shown Open

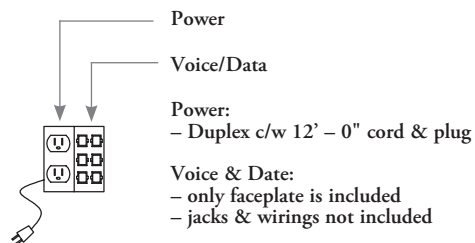
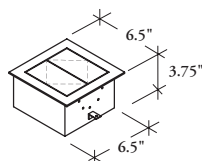

PRODUCT OPTIONS

Finish

- 1 Black
- 2 Stainless Steel

SAMPLE ORDER CODE

ZAGSH 1

PRICING

Black	Stainless Steel
2110	3356

Compliance

All electrical items are UL listed and comply with the requirements of the National Electric Code. However, items on this page may not meet other local electrical codes. Specific requirements for various localities are the responsibility of the ordering party and it is understood that local code compliance is the responsibility of the buyer.

ZAGPS

Phantom Spider Box

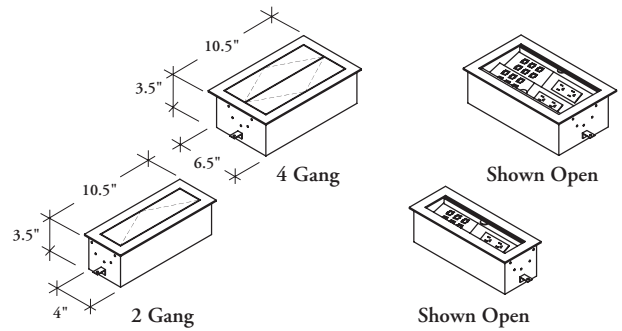
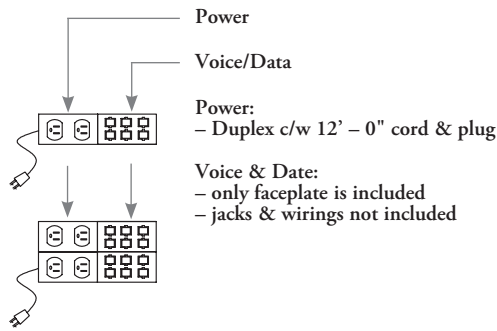

PRODUCT OPTIONS

Style	Finish
2 2 Gang	1 Black
4 4 Gang	2 Stainless Steel

SAMPLE ORDER CODE

ZAGPS 2	2
---------	---

STYLE

PRICING

	Black	Stainless Steel
2	1840	2859
4	2405	3355

Compliance

All electrical items are UL listed and comply with the requirements of the National Electric Code. However, items on this page may not meet other local electrical codes. Specific requirements for various localities are the responsibility of the ordering party and it is understood that local code compliance is the responsibility of the buyer.

ZAGFUS

Flip-Up Electrical Box – Standard

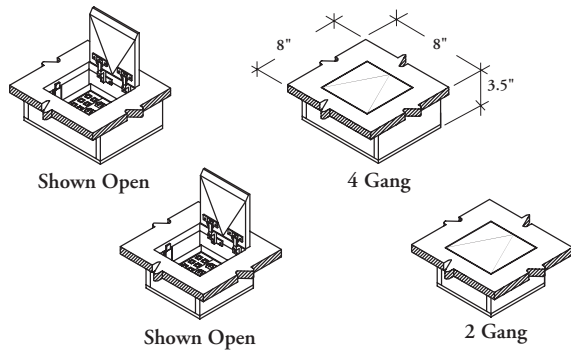

NOTES

Please see finish listing with codes in the Wood / Caseloads Introduction Booklet.

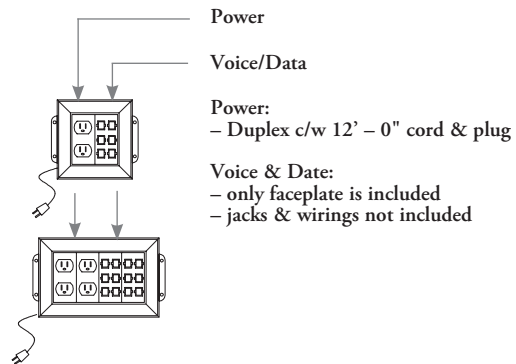

PRODUCT OPTIONS

Style	Finish
2 2 Gang 4 4 Gang	60 Platinum (Painted MDF) Natural Veneer Custom Wood Stain

SAMPLE ORDER CODE

ZAGFUS 2	UH
----------	----

STYLES

PRICING

2	2027
4	2126

To order a Custom Color for Conference Tables please use the code ZCCWS. A one time 1267 list charge per color applies.

Compliance

All electrical items are UL listed and comply with the requirements of the National Electric Code. However, items on this page may not meet other local electrical codes. Specific requirements for various localities are the responsibility of the ordering party and it is understood that local code compliance is the responsibility of the buyer.

NOTES

Please see finish listing with codes in the Wood / Casegoods Introduction Booklet.

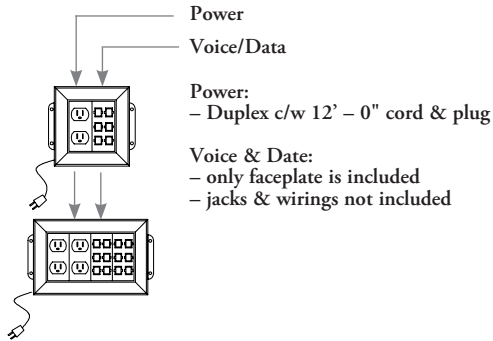

ZAGFUHA

Flip-Up Electrical Box with Half Moon Cut-Out Cable Access

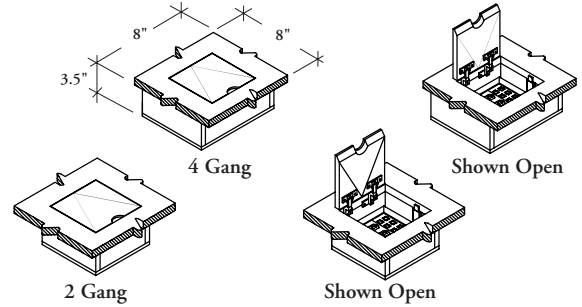

PRODUCT OPTIONS

Style	Finish
2 2 Gang 4 4 Gang	60 Platinum (Painted MDF) Natural Veneer Custom Wood Stain

SAMPLE ORDER CODE

ZAGFUHA 2	UH
------------------	-----------

STYLES

PRICING

2	2027
4	2126

To order a Custom Color for Conference Tables please use the code ZCCWS. A one time 1267 list charge per color applies.

ZAGFUNA

Flip-Up Electrical Box with Black Nylon Brush Cable Access

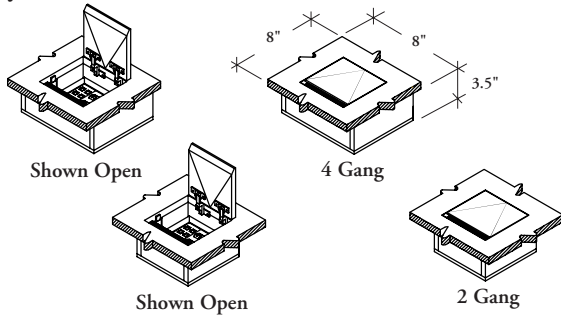

NOTES

Please see finish listing with codes in the Wood / Caseloads Introduction Booklet.

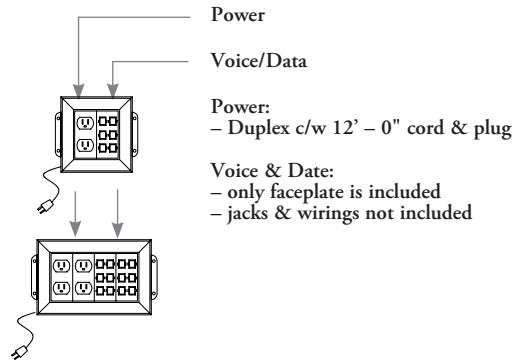

PRODUCT OPTIONS

Style	Finish
2 2 Gang 4 4 Gang	60 Platinum (Painted MDF) Natural Veneer Custom Wood Stain

SAMPLE ORDER CODE

ZAGFUNA 2	UH
-----------	----

STYLES

PRICING

2	2223
4	2322

To order a Custom Color for Conference Tables please use the code ZCCWS. A one time 1267 list charge per color applies.

WHAT'S INCLUDED

1 grommet (as specified).

**ZAG
Grommet**

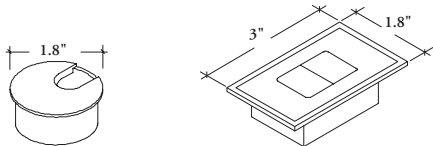

PRODUCT OPTIONS

Style	
OPA	Round Black Plastic
OMA	Round Black Metal
OMB	Round Polished Brass Metal
OMC	Round Satin Chrome Metal
OMD	Round Polished Chrome Metal
OME	Round Antique Brass Metal
RMA	Rectangular Black Metal

SAMPLE ORDER CODE

ZAG OPA

PRICING

Plastic	Round Metal	Rectangular Metal
89	190	276

conferencing

accessories

Z A V B Cana Visual Board

Page 71

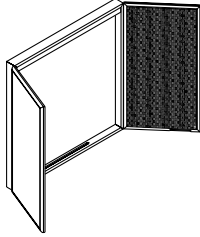

Z W V P Westcoast Visual Board

Page 72

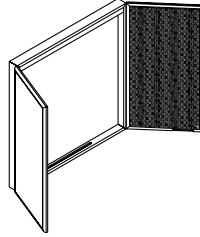

Z A P R S Projection Screen

Page 73

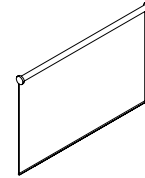

general information

GENERAL:

All dimensional codes (listed throughout the text and under options) are nominal figures – they are not actual dimensions.

Wall Mounted Cabinets

All wall mounted cabinets and shelves include a separate wall cleat that is sized to support the cabinet, but does not include wall cleat attachment hardware. The structural capacity of the support wall and the anchoring of the cleat to the wall are beyond the control and expertise of Teknion. It is, therefore, understood by all parties involved that it is the responsibility of the buyer, owner, and/or installer to consult with the building owner, architect, interior designer, structural engineer, and/or contractor to ensure that the supporting wall structure and cleat attachment method will support the size and weight of the specific cabinet selected from the Halcon price list.

Casegoods

Refer to the corresponding product line sections of Teknion's Wood binder for a complete offering of casegoods products.

FINISHES:

For details on the finishes available for Conferencing products, please see the Wood/Casegoods Introduction booklet.

Please refer to Teknion's Fabrics & Finishes Program guide to view finish sample cards and to order individual finish samples.

Custom Wood Stain

For custom wood finishes add 676 list per match. This is a one time matching charge. Please see the Wood/Casegoods Introduction booklet for details.

OPTIONS:

Lighting/Accessories

In addition to the lighting and accessory products offered in this guide, please see Complements: Teknion's *Ergonomics & Accessories Program* for a listing of additional Keyboard Supports & Accessories.

Complements: Teknion's *Ergonomics & Accessories Program* - is designed to organize and personalize the workspace and promote healthy working postures. Complements products integrate with all Teknion furniture and can be applied to complete and enhance individual workstations, group work areas and public spaces.

Grommets

Where applicable, grommets and wire trays are available to facilitate all your wire management needs. In the high-tech office environment, these components are a must to maintain a professional look without compromising function!

WHAT'S INCLUDED

Flip chart, marker and eraser, magnetic whiteboard on interior.

**ZAVB
Cana Visual Board**

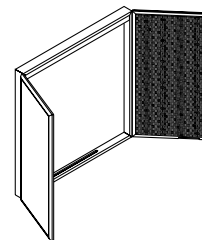

PRODUCT OPTIONS

Width	Height	Frame Finish	Edge Detail	Tack Panel Finish
48, 60	48	Natural Veneer Custom Wood Stain	CG Pencil Edge CP Radius Edge	Panel Fabric

SAMPLE ORDER CODE

ZAVB 48	48	UH	CG	R543
----------------	-----------	-----------	-----------	-------------

**DIMENSIONS
INCHES / MM**

W	H
48 / 1219	48 / 1219
60 / 1524	48 / 1219

PRICING

PENCIL EDGE

COM/A	Gr. 1	Gr. 2	Gr. 3	Gr. 5	Gr. 6	Gr. 7
6411	6430	6494	6522	6618	6676	6728
7274	7293	7357	7385	7481	7539	7591

RADIUS EDGE

COM/A	Gr. 1	Gr. 2	Gr. 3	Gr. 5	Gr. 6	Gr. 7		
48 / 1219	48 / 1219	7281	7300	7364	7392	7488	7546	7598
60 / 1524	48 / 1219	7909	7927	7991	8019	8115	8173	8226

To order a Custom Color for Conferencing products please use the code ZCCWS. A one time 1267 list charge per color applies.

Z W V B

Westcoast Visual Board

WHAT'S INCLUDED

Flip chart, marker and eraser, magnetic whiteboard on interior.

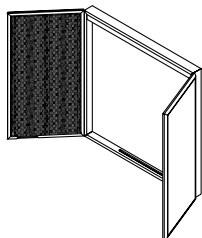

PRODUCT OPTIONS

Width	Height	Frame Finish	Edge Detail (on top cap)	Tack Panel Finish
48, 60	48	Natural Veneer Custom Wood Stain	JR Bevel JS Classic JT Arch JV Dome JW Reed	Panel Fabric

SAMPLE ORDER CODE

ZWVB 48	48	UH	JR	R543
----------------	-----------	-----------	-----------	-------------

DIMENSIONS INCHES / MM

W	H
48 / 1219	48 / 1219
60 / 1524	48 / 1219

PRICING

COM/A	Gr. 1	Gr. 2	Gr. 3	Gr. 5	Gr. 6	Gr. 7
8110	8127	8191	8217	8318	8373	8423
8813	8833	8897	8923	9022	9083	9133

To order a Custom Color for Conferencing products please use the code ZCCWS. A one time 1267 list charge per color applies.

ZAPRS
Projection Screen

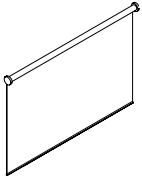

PRODUCT OPTIONS

Width
48, 60

SAMPLE ORDER CODE

ZAPRS 48

DIMENSIONS INCHES / MM	PRICING
W	
48 / 1219	664
60 / 1524	893

teknion

www.teknion.com

IN CANADA:

1150 Flint Road
Toronto, Ontario
M3J 2J5 Canada
Tel 866.teknion
866.835.6466

IN THE USA:

350 Fellowship Road
Mt Laurel, New Jersey
08054 USA
Tel 877.teknion
877.835.6466

OTHER OFFICES LOCATED IN:

Europe, South and Central America
Middle East, Asia and Russia
For regional contact information
go to www.teknion.com

CAN/US/INT 10-24

©Teknion 2022

®, ™ trade marks of Teknion
Corporation and/or its subsidiaries or
licensed to it. Patents may be pending.

Some products may not be available
in all markets. Contact your
local Teknion Representative for
availability.

OCT22-WC-TC