

contents

INTRODUCTION	3
PANEL WALLS	15
FASCIAS	51
THIN PANELS	83
SCREENS	147
CONNECTIONS & TRIMS	159
WORKSURFACES	197
STORAGE	227
SUPPORTS	251
ACCESSORIES	289
ELECTRICS	299

introduction

introduction

WHERE TO FIND THE INFORMATION YOU NEED5

HOW TO MAKE THIS GUIDE WORK FOR YOU6















INDEX – BY SECTION8

INDEX – BY PRODUCT11

where to find the information you need

Teknion provides an array of tools and information resources to help you get things done simply and easily. From product pricing to application guidelines to online planning suggestions, you will find what you need when you need it.

The following is a directory of available resources:

Product Pricing  	<p>Web Pricing access to all up-to-date pricing, as well as partially updated and complete Price Guides in PDF format can be found at www.teknion.com/products/default.asp and selecting the pricing tab.</p> <p>Printed Price Guides by product line containing product maps, detailed pricing tables and product basics information are available to help you specify correctly. These guides can be ordered online through the order literature link at teknion.com or by contacting your local Teknion Representative.</p> <p> Please review the online guides for the most up-to-date information prior to placing your order.</p>
Application Guidelines  	<p>Web Access to partially updated and complete Application Guides in PDF format can be found at www.teknion.com/products/default.asp and selecting the pricing tab.</p> <p>Printed Application Guides by product line containing detailed application guidelines as well as tips to help you plan and specify each of our products are available. These guides can be ordered online through the order literature link at teknion.com or by contacting your local Teknion Representative.</p>
Planning Ideas 	<p>Web Planning Tool Select and view typicals of our products by solution, size or price with a click of your mouse. Get great ideas and save time!</p> <p>Web Access is available by selecting the tool kit link found on the top navigation bar of teknion.com.</p>
Weights & Volumes 	<p>Web Access to Weights & Volumes can be found by selecting the additional information link at teknion.com on specific product pages within the pricing sections.</p>
Fabrics & Finishes  	<p>Teknion's fabrics and finishes offering includes the following programs; Standard Panel and Seating Fabrics & Finishes, Graded-In Panel and Seating Fabrics.</p> <p>Web Access is available by selecting the Fabrics & Finishes link at teknion.com within each product line home page.</p> <p>Printed Fabrics & Finishes Guides can be ordered online through the order literature link at teknion.com or by contacting your local Teknion Representative.</p>
Product Photos & Drawings 	<p>Web Access to all photos, line drawings and renderings are available by selecting the Photo Bank link at teknion.com.</p> <p>Image CDs are also available upon request. Contact your Teknion Customer Service Representative.</p>
Order Forms 	<p>All forms, from COM Forms to Key Charts.</p> <p>Web Access is available by selecting the additional information link at teknion.com on specific product pages within the pricing sections.</p>
Warranty/Terms & Conditions of Sale 	<p>Web Access is available by selecting the legal link found on the top navigating bar at teknion.com.</p>
Installation Guides 	<p>Installation Guides are available on CDs or at Tekniontips.com (Canada) or Teknioninfo.com (U.S.A.).</p>
User Feedback 	<p>How is our marketing material working for you?</p> <p>Feedback from the user is very important to the quality of Teknion's marketing material. We ask that if you have suggestions on how you think we could improve content OR if you have found an error, that you please email us at pricebookchanges@teknion.com.</p>



Available in Printed Format



Available Electronically

introduction

how to make this guide work for you

price guide contents

This guide contains all the information you need to order this product manually or through your specification software. The Introduction section provides everything you need to get started and the subsequent sections provide detailed pricing and specification information by product type. Each of these sections contains overview pages to explain key application and specification guidelines that will help you specify the product correctly. The detailed pricing pages follow.

6

price guide

- Introduction
- Index by section
- Index by product
- Product Maps by section
- Specification 'Basics' by section
- Pricing by section

basics page at a glance

It is recommended that you review the basics pages before you begin specifying a product. For more detailed application and planning information refer to the appropriate Application Guide.

Section Title → panel walls

Page Title → full-height window basics

Product Overview Statement → Full-Height Windows are used in place of a panel wall to provide a full-height glass alternative. The following outlines the features.

Page Number → 26

Product Name/Code, application notes, dimensions and finishes (as applicable) → Full-Height (H Style) - Double Glass (MINIPOWER) Windows

- Used in place of a Full-Height Wall (MINIPOWER)
- Available in widths up to 150cm for panel heights up to 180cm and widths up to 120cm for panel heights up to 160cm
- Available in Standard Glass Clear and Frost
- Standard Glass, Clear is a tempered glass; Standard Glass, Frost is a sandblasted tempered glass
- Frames are available in Clear Anodized, Espresso and Storm White paint finishes
- Top trims and Kick Base Panels must be specified separately

Product Name/Code, application notes, dimensions and finishes (as applicable) → Double Full Height (D Style) - Double Glass (MINIPOWER) Windows

- Used in place of an Elevated Panel Wall (MINIPOWER)
- Available in widths up to 150cm for panel heights up to 180cm and widths up to 120cm for panel heights up to 160cm
- Available in Standard Glass Clear and Frost
- Standard Glass, Clear is a tempered glass; Standard Glass, Frost is a sandblasted tempered glass. Clear tempered glass will be applied to the opposite side of the double glass window when Frost
- Frames are available in Espresso, Clear Anodized and Storm White paint finishes
- Top trims and Kick Base Panels must be specified separately

Last update for this page → district price guide - September 25, 2015

how to make this guide work for you

pricing details at a glance

Section Title → panel walls

Product Code/Name → M U N P F R
Flush Panel Wall

Product Illustration →

Page Number → 28

Feature and finish options you may select from when specifying →

Product Description, What's Included, What's Excluded (where applicable) and Notes (where applicable) →

Product Dimensions in inches and millimeters →

Height	Width	Panel Frame
75,100,120,135,50, 165	50,60,69, 80,12, 14, 15, 16, 18, 20, 24	Base Frame

Sample Order Code →

M U N P F R 120 | 06 | Panel Matrix

Pricing table categorized by dimensions and price-relevant finishes (where applicable) →

DIMENSIONS CM			DIMENSIONS IN		
H	W	PRICING	H	W	PRICING
075 / 75	06 / 60	223	120 / 120	06 / 60	303
075 / 75	09 / 90	234	120 / 120	09 / 90	315
075 / 75	09 / 90	236	120 / 120	09 / 90	317
075 / 75	10 / 100	276	120 / 120	10 / 100	362
075 / 75	12 / 120	280	120 / 120	12 / 120	375
075 / 75	14 / 140	296	120 / 120	14 / 140	394
075 / 75	15 / 150	303	120 / 120	15 / 150	400
075 / 75	16 / 160	407	120 / 120	16 / 160	615
075 / 75	18 / 180	468	120 / 120	18 / 180	645
075 / 75	20 / 200	513	120 / 120	20 / 200	723
075 / 75	24 / 240	562	120 / 120	24 / 240	748
105 / 105	06 / 60	238	135 / 135	06 / 60	308
105 / 105	09 / 90	248	135 / 135	09 / 90	320
105 / 105	09 / 90	251	135 / 135	09 / 90	323
105 / 105	10 / 100	297	135 / 135	10 / 100	368
105 / 105	12 / 120	302	135 / 135	12 / 120	381
105 / 105	14 / 140	317	135 / 135	14 / 140	398
105 / 105	15 / 150	323	135 / 135	15 / 150	404
105 / 105	16 / 160	503	135 / 135	16 / 160	619
105 / 105	18 / 180	566	135 / 135	18 / 180	649
105 / 105	20 / 200	593	135 / 135	20 / 200	727
105 / 105	24 / 240	643	135 / 135	24 / 240	752

Last update for this page → district price guide – September 25, 2015

additional information

The following forms are available at www.tekunion.com/products to help you specify and place your order if required:

Teknypaint	If you require a custom paint color match you must submit a TekniPaint form.
Using your Own Material (COM)	<p>If you wish to use your own material on fabric-covered products, you must submit a completed TekniPlate form including a sample upholstery and safety testing.</p> <p>A COM Order Information Sheet must also be submitted. This form captures all relevant ordering and tracking information.</p> <p>A COM Request for Yardage Calculation form may be sent to Teknion for preliminary yardage requirements.</p>
Noting Key Requirements	If you require that certain pieces share the same locks provide your key requirements on a key chart which can be printed from our website.
Summarizing Coordinating Tag Areas	Summarize any coordinating groupings on to a Tag Worksheet. There are spaces on the form to describe all common features and finish options for specific tag areas or an entire order. A tag area can be as small as a worksurface and as big as an entire floor.
Placing a Manual Order	Complete an Order Cover Sheet with the information we need to fill your order. This is the most important step. If the Order Cover Sheet is not complete and correct, the order may be delayed.

Section Contents	Product Code	Page No.
introduction		
Where to find the information you need		5
How to make this guide work for you		6
panel walls		
Panel Wall Overview		18
Panel Wall Basics		20
Panel Wall Base & Foot Basics		21
Support Foot Basics		22
Add-On Window Basics		23
Full-Height Window Basics		24
Flush Panel Wall	MUNPFR	26
Flush Panel with Accessory Beam	MUAFFR	28
Elevated Panel Wall	MUNPER	30
Elevated Panel with Accessory Beam	MUAFER	32
Convertible Panel Wall	MUNPC	34
Convertible Panel with Accessory Beam	MUAFCR	36
Add-On Window (L-Style) – Double Glass	MUNPLD	38
Flush Full-Height Window (D-Style) – Single Glass	MUNPFWDR	40
Elevated Full-Height Window (D-Style) – Double Glass	MUNPEWDR	42
Convertible Panel Wall Base and Foot Trim	MUNPCF	44
Elevated Panel Wall Foot	MUNPEFR	46
Support Foot for Freestanding District	MUAFFN	47
Panel Wall Rail	MUNPHN	48
Light Block Rail	MUNEX	49
fascias		
Fascia Overview		54
Fascia Overview for Freestanding District		55
Fascia Basics		56
Solid Fascia	MUNESD	60
Solid Fascia For Freestanding District (Clip Mount)	MUAESD	62
Solid Fascia – Full-Height	MUNESF	64
Metal Fascia	MUNELM	66
Metal Fascia For Freestanding District (Slot Mount)	MUAELM	68
Tackable Fabric Fascia	MUNELF	70
Tackable Fabric Fascia For Freestanding District (Slot Mount)	MUAELF	72
Whiteboard Fascia	MUNEMB	74
Accessory Fascia	MUNELA	75
Metal Base Feed Fascia	MUNELMB	76

Section Contents	Product Code	Page No.
Metal Base Feed Fascia For Freestanding District (Slot Mount)	MUAELMB	77
Fabric Base Feed Fascia For Freestanding District (Slot Mount)	MUAELFB	78
Window (L-Style) – Double Glass	MUNELWD	79
Fascia Clip Kit	MUNELK	80
thin panel		
Thin Panel Overview		86
Thin Panel Planning		88
Thin Panel Basics		89
Fabric Bottom, Fabric Top District Std Thin Panel	MUFF	90
Fabric Bottom, Fabric & Whiteboard Top District Std Thin Panel	MUFFW	94
Fabric Bottom, Whiteboard Top District Std Thin Panel	MUWF	98
Fabric & Metal Bottom, Fabric Top District Std Thin Panel	MUFMF	102
Metal & Fabric Bottom, Fabric & Whiteboard Top District Std Thin Panel	MUFMW	106
Fabric & Metal Bottom, Whiteboard Top District Std Thin Panel	MUWMF	110
Metal Bottom, Fabric Top District Std Thin Panel	MUFM	114
Metal Bottom, Fabric & Whiteboard Top District Std Thin Panel	MUWFM	118
Metal Bottom, Whiteboard Top District Std Thin Panel	MUWM	122
Glaze Add-On Screen	MUAG	126
Fabric District Monolithic Panel	MUMAF	127
Fabric & Metal District Monolithic Panel	MUMFM	128
Metal District Monolithic Panel	MUMAM	129
Fabric & Whiteboard District Monolithic Panel	MUMFW	130
Whiteboard District Monolithic Panel	MUMAW	131
Glaze District Monolithic Panel	MUMAG	132
Fabric Bottom & Glaze Top District Thin Panel	MUGF	134
Fabric & Metal Bottom, Glaze Top District Thin Panel	MUGMF	138
Metal Bottom, Glaze Top District Thin Panel	MUGM	142
screens		
Screens Overview		150
Desk Top Screen Basics		151
Modesty and Panel Wall Add-On Basics		152

Section Contents	Product Code	Page No.
Desk Top Casual Screen	MUNSDT	154
Desk Top Mounted Screen	MUNSBWS	155
Modesty Screen	MUNSM	156
Panel Wall Add-On Screen – Glass	MUNSPG	157
Connections & trims		
Trims & Connectors Overview		162
Trim Basics		163
Connector Basics		164
Thin Panel Connector		166
Thin to Thick Connector Basics		169
Thin to Thin Connector Basics		170
Top Trim	MUNTT	172
Top Trim – Power Pole Access	MUNTPP	173
End Trim	MUNTE	174
End Trim For Freestanding District	MUATE	175
Intermediate End Trim	MUNTM	176
Two-Way 90°	MUNPCR2	177
Three-Way 90°	MUNPCR3	178
Four-Way 90°	MUNPCR4	179
Two-Way 180° Spacer	MUNPCCR	180
Two-Way Intermediate 90°	MUNIC2	181
Three-Way Intermediate 90°	MUNIC3	182
Four-Way Intermediate 90°	MUNIC4	183
Two-Way Intermediate 180°	MUNICC	184
Transition Cover	MUNTC	185
Wall Start	MUNPCW	186
One District with Thin Panel Connector	MUCCT1	187
Four-Way Two District with Two Thin Panel Connector	MUCCT2	188
Three Way District with Thin Panel Connector	MUCCT3D	189
Two Way 90°	MUCCT90	190
Three Way 180°	MUCCT3	191
Four Way 90°	MUCCT4	192
District Thin Panel End Trim	MUET	193
Intermediate Trim	MUDT	194
worksurfaces		
Worksurface Overview		200
Worksurface Basics		201
Worksurface Grain/Pattern Direction		202
Edge Trim Style Overview		204

Section Contents	Product Code	Page No.
Rectangle Worksurface	MUNWR	206
Wedge Worksurface	MUNWW	212
Transition Worksurface	MUNWTN	216
90° Corner Worksurface	MUWDG	224
storage		
Understanding District Storage		230
Storage Overview		233
Pedestal Basics		234
Bookcase Basics		235
Credenza Basics		236
Credenza Drawer Widths		237
Tower Basics		240
Rolling Pedestal	MUPR	242
Lateral File – Standard	MUFLS	243
Bookcase – Standard	MUBKS	244
Low Open with Drawer Credenza – Elevated	MULHE	245
Side Open Tower	MUTW	246
Linking Bracket	MUNSLB	247
Storage Extended Leveling Kit	MUNSXL	248
supports		
Understanding District Supports		256
Worksurface Support Basics – Horizontal		257
Worksurface Support Basics – Vertical		258
Worksurface Support, Freestanding Basics		259
Worksurface-to-Storage Support Basics		260
Storage-to-Panel Support Basics		261
Selecting the Correct Storage-to-Panel Bracket		262
End Gable	MUNGEN	265
End Gable – Height-Adjustable	MUNGEAN	266
Flush End	MUNGEF	267
Flush End – Height-Adjustable	MUNGEFA	268
Mid Gable	MUNGMF	269
Mid Gable – Height-Adjustable	MUNGMFA	270
Cantilever	MUNLVR	271
Off-Module Cantilever	MUNLVFN	272
Cantilever for Panels with Accessory Beam	MUALVFN	273
Semi-Suspended Gable	MUNGSN	274
Semi-Suspended Gable – Height-Adjustable	MUNGSAN	275
Leg – Single	MUNLGN	276

Section Contents	Product Code	Page No.
Leg – Height-Adjustable Single	MUNLGA	277
Leg – Pair	MUNLGPN	278
Leg – Height-Adjustable Pair	MUNLGPA	278
Worksurface Panel Wall Bracket – Pair	MUNBP	279
Worksurface Panel Wall Bracket – Height-Adjustable	MUNBPA	279
Storage-to-Panel Bracket	MUWSPB	280
Height-Adjustable Worksurface-to-Tower Bracket Kit	MUWBTH	281
Low Credenza-to-Worksurface Support	MUNCPWN	282
Flush Plate	MUNRF	283
Structural Flush Plate	MUNRFS	283
Worksurface Reinforcement Channel	MUNRC	284
hiSpace Single Leg	MYSLG	285
hiSpace Adjustable Single Leg	MYSLGA	286
Support Foot for Thin Panel District	MUFFN	287
accessories		
Accessory Overview		292
Seat Cushion Basics		293
Complements Accessory Basics		294
Seat Cushion	MUWLC	296
Signage	MUTPS	297
electrics		
Electrics & Communications Overview		302
Power Entry Basics – Panel-Mounted Workstations		303
Power Pole	MUNQEP	304
Cable Tray for District	MUBT	305

Product Name	Product Code	Page No.
90° Corner Worksurface	MUWDG	224
Accessory Fascia	MUNELA	75
Add-On Window (L-Style) – Double Glass	MUNPLD	38
Bookcase – Standard	MUBKS	244
Cable Tray	MUBT	305
Cantilever	MUNLVR	271
Cantilever for Panels with Accessory Beam	MUALVFN	273
Convertible Panel Wall	MUNPC	34
Convertible Panel Wall Base and Foot Trim	MUNPCF	44
Convertible Panel with Accessory Beam	MUAFCR	36
Desk Top Mounted Screen	MUNSBWS	155
District Thin Panel End Trim	MUET	193
Desk Top Casual Screen	MUNSDT	154
Elevated Full-Height Window (D-Style) – Double Glass	MUNPEWDR	42
Elevated Panel Wall	MUNPER	30
Elevated Panel Wall Foot	MUNPEFR	46
Elevated Panel with Accessory Beam	MUAFER	32
End Gable	MUNGEN	265
End Gable – Height-Adjustable	MUNGEAN	266
End Trim	MUNTE	174
End Trim For Freestanding District	MUATE	175
Fabric Base Feed Fascia For Freestanding District (Slot Mount)	MUAELFB	78
Fabric Bottom, Fabric Top District Std Thin Panel	MUFF	90
Fabric Bottom, Fabric & Whiteboard Top District Std Thin Panel	MUFFW	94
Fabric Bottom, Whiteboard Top District Std Thin Panel	MUWF	98
Fabric & Metal Bottom, Fabric Top District Std Thin Panel	MUFMF	102
Fabric & Metal Bottom, Whiteboard Top District Std Thin Panel	MUWMF	110
Fabric District Monolithic Panel	MUMAF	127
Fabric & Metal District Monolithic Panel	MUMFM	128
Fabric & Whiteboard District Monolithic Panel	MUMFW	130
Fabric Bottom & Glaze Top District Thin Panel	MUGF	134
Fabric & Metal Bottom, Glaze Top District Thin Panel	MUGMF	138
Fascia Clip Kit	MUNELK	80
Flush End Gable	MUNGEF	267
Flush End Gable – Height-Adjustable	MUNGEFA	268

Product Name	Product Code	Page No.
Flush Full-Height Window (D-Style) – Double Glass	MUNPFWDR	40
Flush Panel Wall	MUNPFR	26
Flush Panel with Accessory Beam	MUAFFR	28
Flush Plate	MUNRF	283
Four-Way 90°	MUNPCR4	179
Four-Way 90°	MUCCT4	192
Four-Way Intermediate 90°	MUNIC4	183
Four -Way Two District with Two Thin Panel Connector	MUCCT2	188
Glaze Add-On Screen	MUAG	126
Glaze District Monolithic Panel	MUMAG	132
Height-Adjustable Worksurface-to-Tower Bracket Kit	MUWBTH	281
hiSpace Single Leg	MYSLG	285
hiSpace Adjustable Single Leg	MYSLGA	286
Intermediate End Trim	MUNTM	176
Intermediate Trim	MUDT	194
Lateral File – Standard	MUFLS	243
Leg – Height-Adjustable Pair	MUNLGPA	278
Leg – Height-Adjustable Single	MUNLGA	277
Leg – Single	MUNLGN	276
Leg – Pair	MUNLGPN	278
Light Block Rail	MUNEX	49
Linking Bracket	MUNSLB	247
Low Credenza-to-Worksurface Support	MUNCPCWN	282
Low Open with Drawer Credenza – Elevated	MULHE	245
Metal Base Feed Fascia	MUNELMB	76
Metal Base Feed Fascia For Freestanding District (Slot Mount)	MUAELMB	77
Metal District Monolithic Panel	MUMAM	129
Metal Fascia	MUNELM	66
Metal Fascia For Freestanding District (Slot Mount)	MUAELM	68
Metal & Fabric Bottom, Fabric & Whiteboard Top District Std Thin Panel	MUFMW	106
Metal Bottom, Fabric Top District Std Thin Panel	MUFM	114
Metal Bottom, Whiteboard Top District Std Thin Panel	MUWM	126
Metal Bottom, Fabric & Whiteboard Top District Std Thin Panel	MUWFM	110
Metal Bottom, Glaze Top District Thin Panel	MUGM	142
Mid Gable	MUNGMF	269
Mid Gable – Height-Adjustable	MUNGMFA	270

introduction

index – by product

Product Name	Product Code	Page No.
Modesty Screen	MUNSM	156
One District with Thin Panel Connector	MUCCT1	187
Off-Module Cantilever	MUNLVFN	272
Panel Wall Add-On Screen – Glass	MUNSPG	157
Panel Wall Rail	MUNPHN	48
Power Pole	MUNQEP	304
Rectangle Worksurface	MUNWR	206
Rolling Pedestal	MUPR	242
Seat Cushion	MUWLC	296
Semi-Suspended Gable	MUNGSN	274
Semi-Suspended Gable – Height-Adjustable	MUNGSAN	275
Side Open Tower	MUTW	246
Signage	MUTPS	297
Solid Fascia	MUNESD	60
Solid Fascia – Full-Height	MUNESF	64
Solid Fascia For Freestanding District (Clip Mount)	MUAESD	62
Storage-to-Panel Bracket	MUWSPB	280
Storage Extended Levelling Kit	MUNSXL	248
Structural Flush Plate	MUNRFS	283
Support Foot for Freestanding District	MUAFFN	47
Support Foot for Thin Panel District	MUFFN	287
Tackable Fabric Fascia	MUNELF	70
Tackable Fabric Fascia For Freestanding District (Slot Mount)	MUAELF	72
Three-Way 90°	MUNPCR3	178
Three-Way 180°	MUCCT3	191
Three-Way District with Thin Panel Connector	MUCCT3D	189
Three-Way Intermediate 90°	MUNIC3	182
Top Trim	MUNTT	172
Top Trim – Power Pole Access	MUNTTTP	173
Transition Cover	MUNTC	185
Transition Worksurface	MUNWTN	216
Two-Way 180° Spacer	MUNPCCR	180
Two-Way 90°	MUNPCR2	177
Two-Way 90°	MUCCT90	190
Two-Way Intermediate 180°	MUNICC	184
Two-Way Intermediate 90°	MUNIC2	181
Wall Start	MUNPCW	186
Wedge Worksurface	MUNWW	212
Whiteboard District Monolithic Panel	MUMAW	131
Whiteboard Fascia	MUNEMB	74
Window (L-Style) – Double Glass	MUNELWD	79
Worksurface Panel Wall Bracket – Height-Adjustable	MUNBPA	279
Worksurface Panel Wall Bracket – Pair	MUNBP	279
Worksurface Reinforcement Channel	MUNRC	284

panel walls

panel walls

PRODUCT MAP / TABLE OF CONTENTS	15
PANEL WALL OVERVIEW	18
PANEL WALL BASICS	20
PANEL WALL BASE & FOOT BASICS	21
SUPPORT FOOT BASICS	22
ADD-ON WINDOW BASICS	23
FULL-HEIGHT WINDOW BASICS	24
PRODUCT LISTING	26

panel walls

product map

MUNPFR Flush Panel Wall

Page 26
Height: 75cm – 165cm /
Width: 60cm – 240cm (20cm increments)



MUAFFR Flush Panel with Accessory Beam

Page 28
Height: 75cm / Width: 60cm – 240cm
(20cm increments)

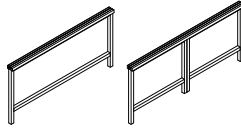

MUNPER Elevated Panel Wall

Page 30
Height: 75cm – 165cm /
Width: 60cm – 240cm (15cm increments)

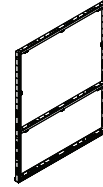

MUAFER Elevated Panel with Accessory Beam

Page 32
Height: 35cm / Width: 60cm – 240cm (20cm increments)

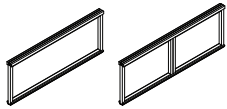

MUNPC Convertible Panel Wall

Page 34
Height: 75cm – 165cm /
Width: 60cm – 240cm (20 increments)



MUAFCR Convertible Panel with Accessory Beam

Page 36
Height: 75cm / Width: 60cm – 240cm" (20cm increments)

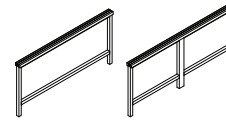

MUNPLD Add-On Window (L-Style) – Double Glass

Page 38
Height: 30cm – 50cm /
Width: 60cm – 240cm (20cm increments)

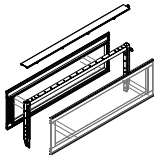

MUNPFWDR Flush Full-Height Window (D-Style) – Double Glass

Page 40
Height: 75cm – 165cm /
Width: 60cm – 240cm (20cm increments)

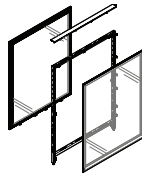

MUNPEWDR Elevated Full-Height Window (D-Style) – Double Glass

Page 42
Height: 75cm – 65cm /
Width: 60cm" – 150cm (20cm increments)

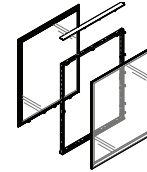

MUNPCF Convertible Panel Wall Base and Foot Trim

Page 44
Width: 60cm – 240cm (15cm increments)



MUNPEFR Elevated Panel Wall Foot

Page 46



MUAFFN Support Foot for Freestanding District

Page 47

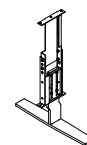

MUNPHN Panel Wall Rail

Page 48
Width: 60cm – 150cm

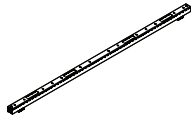

MUNEX Light Block Rail

Page 49
Width: 60cm – 150cm

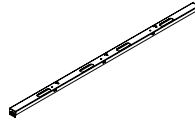

panel walls

panel wall overview

District panels provide space division and power distribution, either with panel walls which require worksurfaces & storage for support, or freestanding which uses support feet for support provide maximum flexibility in planning, aesthetics and cost.

- Panels are available in widths from 60cm to 240cm to provide a clean aesthetic with minimal vertical seams
- Widths over 160cm consist of two equal sized internal frames
- Fascias can span across the full width of the panel (panels are available in heights of 75cm, 105cm, 120cm, 135cm, 150cm & 165cm offers the option for an integrated accessory rail) or be segmented to provide additional functionality to the panel
- Panels can accommodate power and data above and below worksurface heights
- All 75cm high panels are available with an integrated accessory beam for the addition of Interpret screens and storage.

panel walls

Three panel profiles are available:

- Flush, which provides privacy to the floor;
- Elevated, which provides a 15cm high open space at the bottom of the panel to allow for air flow and a lighter aesthetic;
- Convertible, which provides an economical alternative to the Flush and Elevated Panel and allows the flexibility to convert from a Flush Panel to an Elevated Panel using the same frame

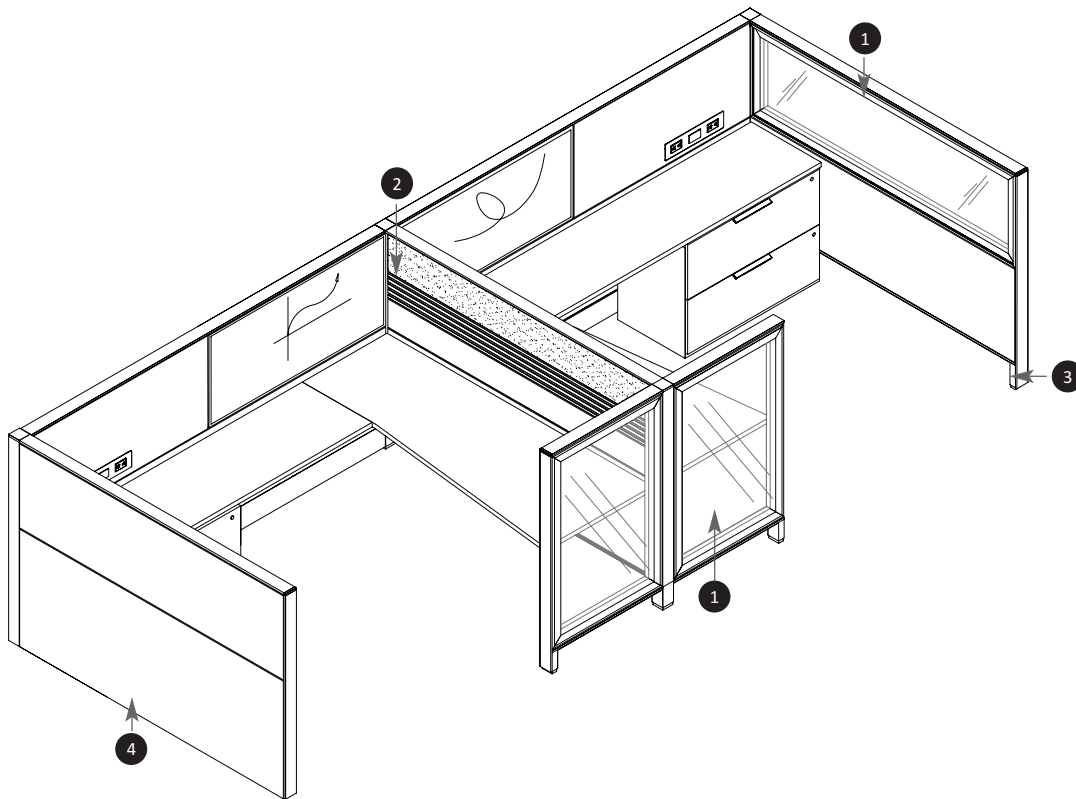

- 1 Glass options are available either as Full-Height Windows or as an Add-On to the panel wall.
- 2 The addition of Panel Wall Rails and Light Block Rails allow for horizontal segmentation above the 75cm high worksurface datum height
- 3 Panel Wall Feet and Trims are available for finishing the base of elevated panels.
- 4 Metal Element are available either at full height or 15cm from floor

panel wall overview (continued)

freestanding panels

Two panel profiles are available:

- Flush, which provides privacy to the floor;
- Convertible, which provides an economical alternative to the Flush

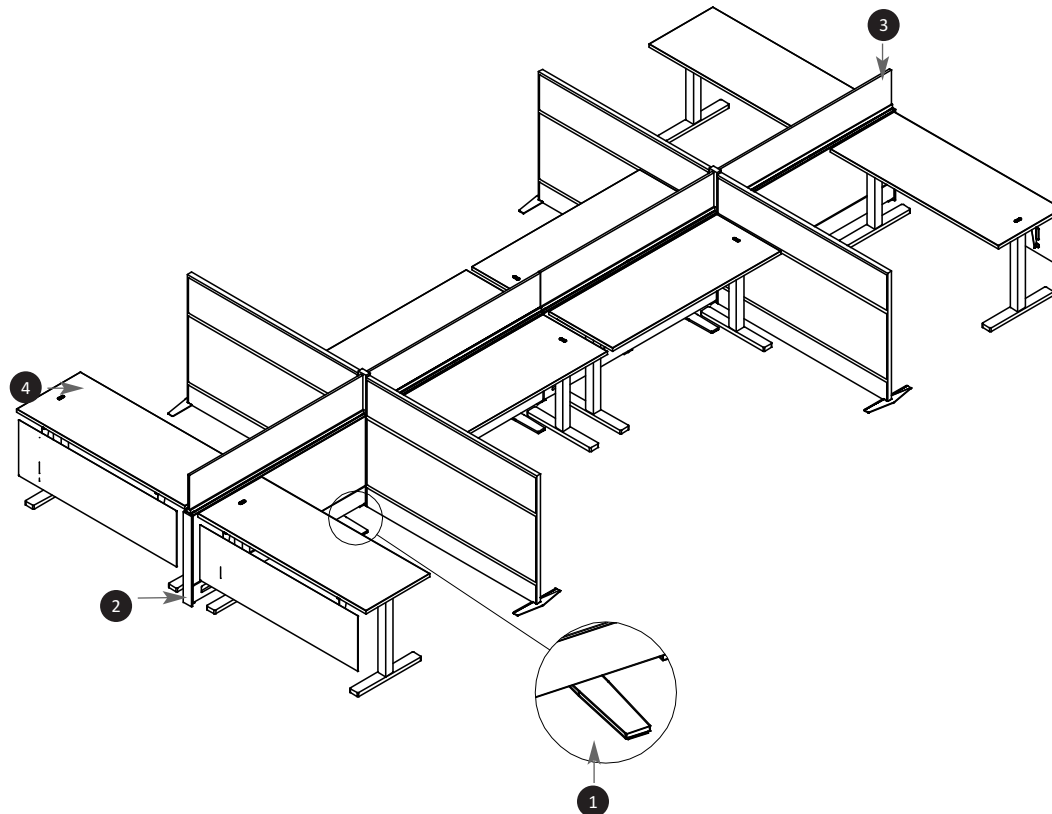

- 1 Panels are supported by feet at the beginning along the run, and at the end of the panel. There must be a support foot at both the start and the ends of a panel run in addition to one every 240cm minimum.
- 2 72cm high panels are available with an integrated accessory beam for the addition of Interpret screens and storage.
- 3 Freestanding Panels cannot exceed 120cm, this can be achieved as a 120cm high panel, a 75cm or 105cm high panel with screens, a 75cm high panel with stanchions and 235cm high storage, or a 105cm high panel with a 22.5cm high storage.
- 4 Freestanding panels are designed to accommodate freestanding tables such as hiSpace(see Complements metric - Teknion's Ergonomics & Accessories Program for further details).

panel wall basics

District panels are available in three styles, Flush, Elevated & Convertible with options for integrated accessory beams at 75cm high.

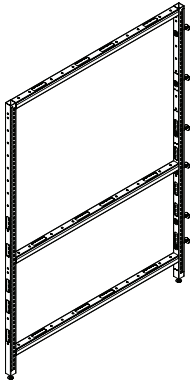

Flush Panel Wall (MUNPFR)

- Available in heights of 75cm, 105cm, 120cm, 135cm, 150cm & 165cm
- The 75cm, 105cm, 120cm, 135 & 150cm high frame can be used in freestanding application

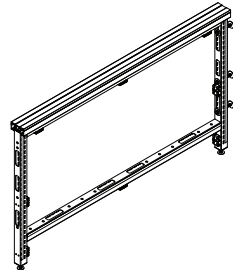

Flush Panel Wall with Accessory Beam (MUAFFR)

- Available 75cm high only
- Complete with an accessory beam to accommodate Interpret screens and storage
- Can be used in freestanding applications

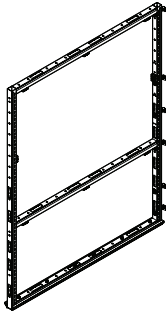

Elevated Panel Wall (MUNPER)

- Available in heights of 75cm, 105cm, 120cm, 135cm, 150cm & 165cm
- Cannot be used in a freestanding application

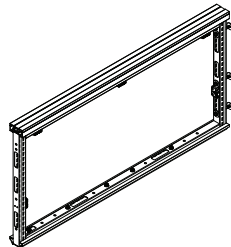

Elevated Panel Wall with Accessory Beam (MUAFER)

- Available in 75cm high only
- Complete with an accessory beam to accommodate interpret screens and storage cannot be used in freestanding applications

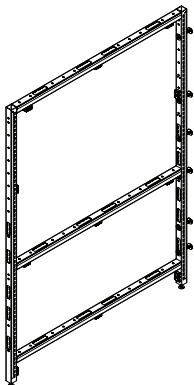

Convertible Panel Wall (MUNPC)

- Available in heights of 75cm, 105cm, 120cm, 135cm, 150 & 165cm
- The 75cm, 105cm & 120cm high can be used in freestanding applications

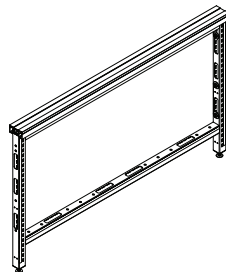

Convertible Panel Wall with with Accessory Beam (MUAFCR)

- Available in 75cm high only
- Complete with an accessory beam to accommodate interpret screens and storage can be used in freestanding when fascias extend to the floor

- Flush panel wall consists of a frame to the floor (one or two sections depending on width) and fixed rails at 15cm and 75cm (or 73cm for panels with accessory beam) to allow for horizontal mounting of storage and worksurfaces
- Complete with fascia attachment clips and slots and accepts all fascia types (see Fascia Section for complete product offering)
- Complete with light block strip on vertical and horizontal slots
- Typically recommended for applications where the majority of the fascias will be hard surface fascias that come complete with male Fascia Clips as standard
- Finished in Black

- Consists of a frame (one or two sections depending on width) and fixed rails at 15cm and 75cm (or 73cm for panels with accessory beam) to allow for horizontal mounting of storage and worksurfaces, but does not extend to the floor – the Elevated Panel Wall Foot (MUNPEFR) is attached below the panel frame to reach the desired datum height
- Complete with fascia attachment clips and slots and accepts all fascia types (see Fascia Section for complete product offering)
- Complete with light block strip on vertical and horizontal slots
- Typically recommended for applications where the majority of the fascias will be hard surface fascias and for applications where the aesthetic and finish of the foot are considerations
- Base of the 15cm rail is finished in Foundation or Mica paint finishes

- Provides an economical and flexible alternative to the Flush and Elevated panel frame
- Consists of a frame to the floor (one or two sections depending on width) and fixed rails at 15cm and 75cm to allow for horizontal mounting of storage and worksurfaces
- Does not have fascia attachment clips, is complete with slots only
- The slot patterns will accept both fascias and storage or supports in the same location
- Accepts all fascia types but for Fascias that are complete with fascia clips, a separate mounting clip kit is required for mounting the fascias to the frame
- Can be used for Flush or Elevated applications
- When used in a Flush application fascias are mounted onto the frame to the floor, and when used in an Elevated application additional Convertible Panel Wall Base and Foot Trims (MUNPCF) are added to provide a base trim and foot cover on the frame below the 15cm level
- Typically recommended for applications where the majority of the fascias do not have clips and are slot-mounted

panel wall base & foot basics

Panel Wall Bases and Panel Wall Feet are used for elevated panel wall applications. Panel Wall Rails & Light Block Rails are used for additional segmentation on panels above the 75cm high rail. The following outlines the features of each type.

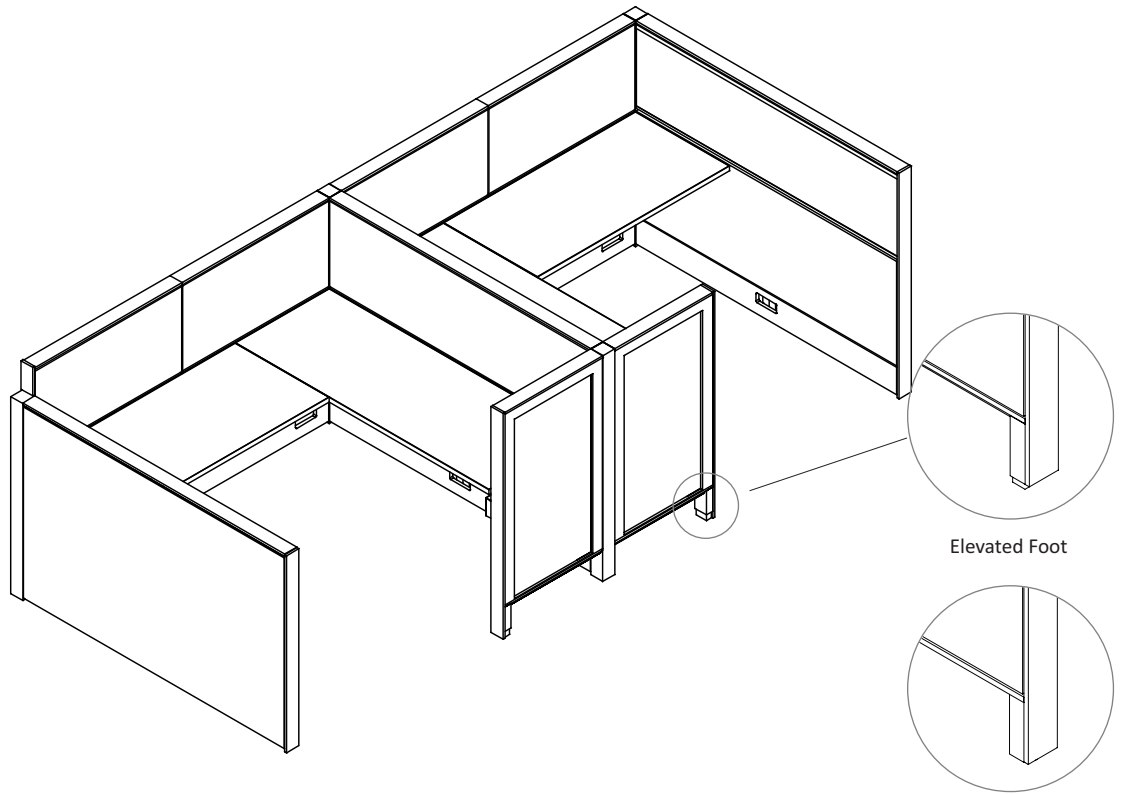

Elevated Panel Wall Foot (MUNPEFR)

- Used with the Elevated Panel Wall (MUNPER)
- Mounted to the base of the panel frame to elevate the frame 15cm above the floor
- Used at all ends and shared between two panels at 180° angles, but are not required at corners or 180° spacers because the connector provides the necessary panel support
- Available in Clear Anodized, Foundation and Mica paint finishes

Elevated Foot

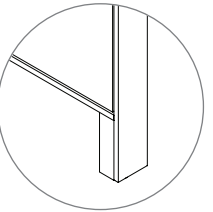

Convertible Base Trim & Foot Cover

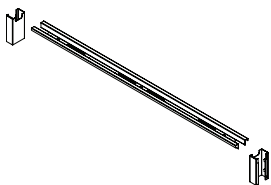

Convertible Panel Wall Base and Foot Trim (MUNPCF)

- Used with Convertible Panel Wall (MUNPC) only in an elevated application
- Consists of a metal trim that is attached to the bottom rail of the panel and elevated feet that snap onto the frame post
- One Convertible Panel Wall Base and Foot Trim is required for all elevated panels 150cm and less. Two are required for elevated panels 15cm and wider as they are made up of two frames (specified as one unit at the overall length)
- The widths must be the width of the two split inner frames
- Available in Foundation and Mica paint finishes

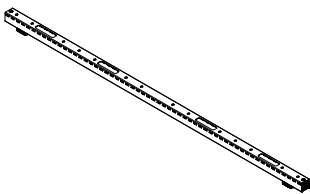

Panel Wall Rail (MUNPHN)

- Complete with clips so can be used on all panels when D-Style Fascia's are specified

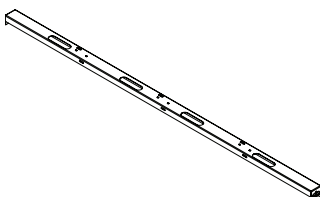

Light Block Rail (MUNEX)

- Provides a light block for fascias with no clips
- Can be used on all panel types when L-Style Fascias are specified

support foot basics

The Support Foot is used to create Freestanding District Panel runs. The following outlines the features of this support.

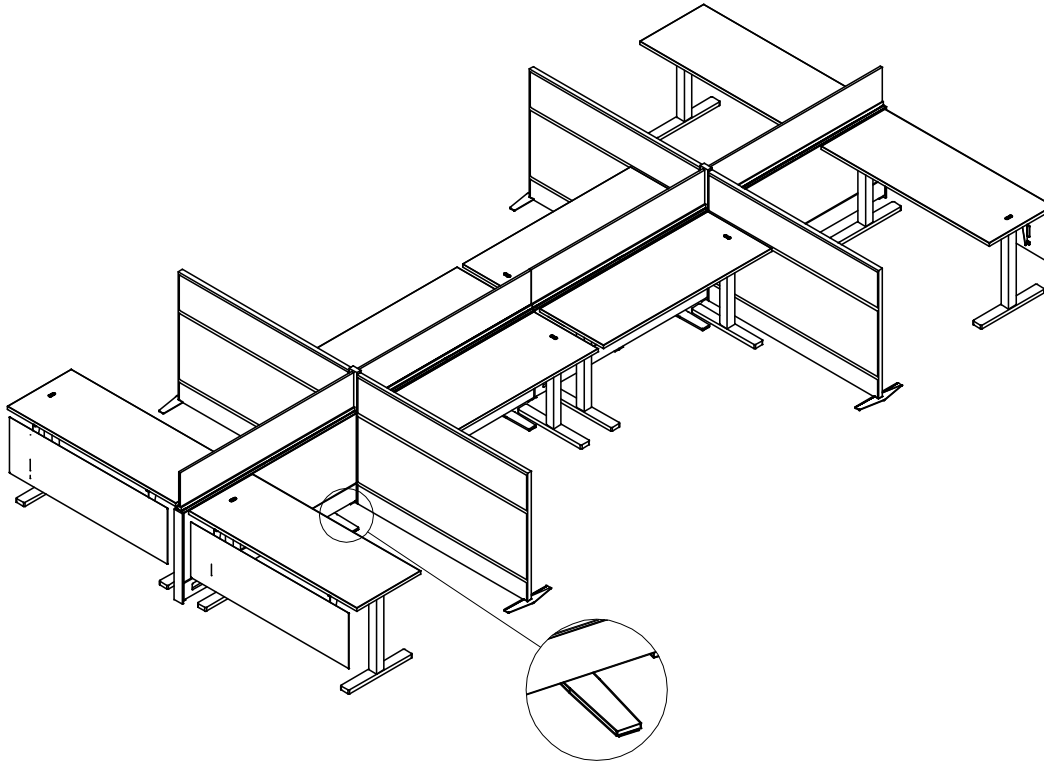

22

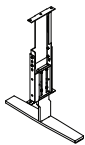

Support Foot for Freestanding District (MUAFN)

- The distance between panel support feet cannot exceed 240cm
- Cannot be used with an Elevated panel
- The Support Foot can be used in any of the four existing hole locations on the bottom of Flush or Convertible panels
- There must be a foot at both start and ends of a panel run
- With support foot freestanding District can be up to 135cm total in height (this can be either a 135cm high panel or a 75cm or 105cm high panel with storage or screens to 135cm high)
- The Support Foot takes up approximately 1.25cm in height therefore a unique fascia program is required for fascias below 75cm high (the height is nominal, therefore 73cm fascia will actually be approximately 72cm to allow for the foot)
- A unique end trim is required, End Trim for Freestanding District (MUATE) to accommodate the height change created by the foot
- Top area of foot offers cable pass through
- Horizontal leveling is done by panel levelers

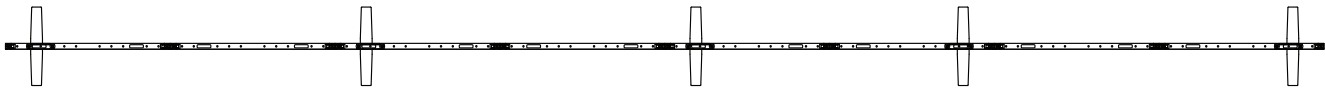

On freestanding panel applications a support foot is needed every 240cm. Extra support feet are recommended when using centermounted overhead storage. There must be at least one support foot on each panel frame.

add-on window basics

Add-On Windows mount on top of a panel wall frame to provide an uninterrupted glass finish. The following outlines the features of add-on windows and full-height windows.

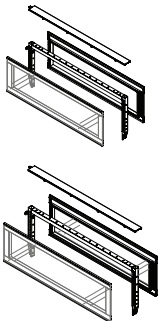
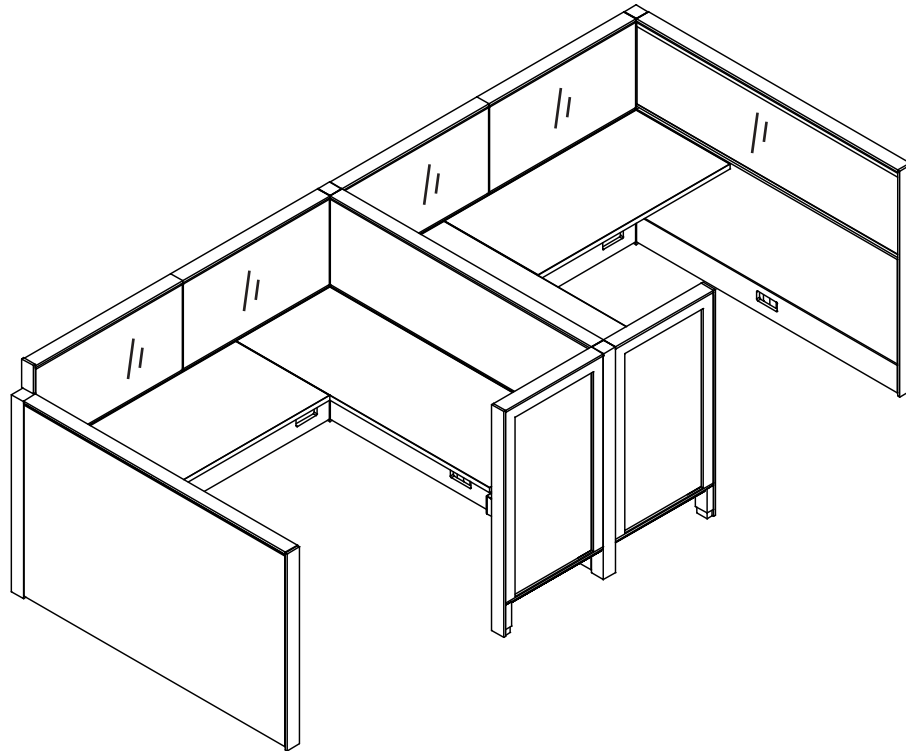

Add-On (L-Style) – Double Glass (MUNPLD) Windows

- Provide a cost effective alternative to the D-Style Glass Add-On Windows
- Mount on-module or semi off-module to the top of a panel wall frame up to a height of 165cm
- frame is visible at the top and bottom only
- Are not load bearing, and cannot be mounted above another add-on window
- Do not affect existing cable routing within the panel wall frame
- Available in Standard Glass Clear and Frost
- Standard Glass, Clear is a tempered glass; Standard Glass, Frost is a etched tempered glass
- Frames are available in Foundation and Mica paint finishes

panel walls

full-height window basics

Full-Height Windows are used in place of a panel wall to provide a full-height glass alternative. The following outlines the features.

24

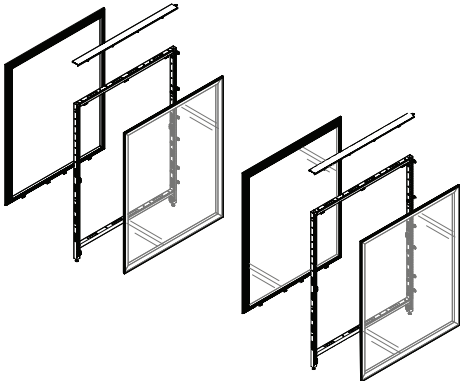
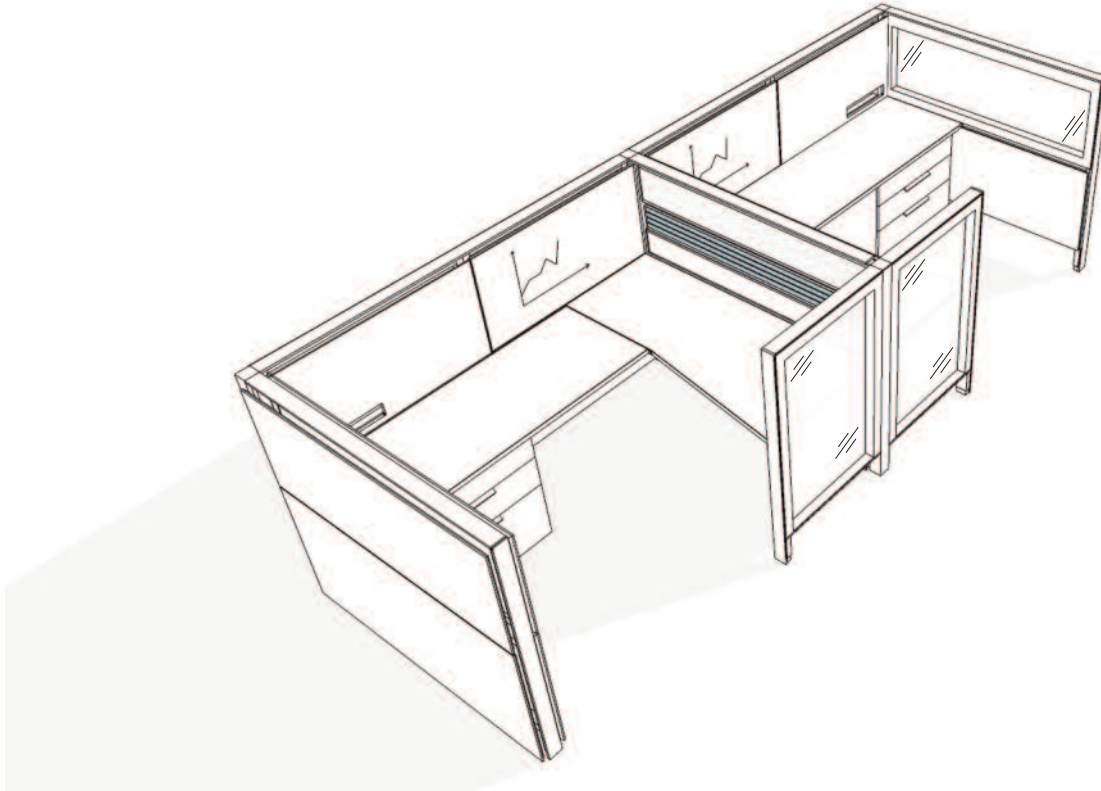

Flush Full-Height (D-Style) – Double Glass (MUNPFWDR) Windows

- Used in place of a Flush Panel Wall (MUNPFR)
- Available in widths up to 150cm for panel heights up to 135cm and widths up to 120cm for panel heights up to 165cm
- Available in Standard Glass Clear and Frost
- Standard Glass, Clear is a tempered glass; Standard Glass, Frost is a etched tempered glass
- Frames are available in Clear Anodized, Espresso and Storm White paint finishes

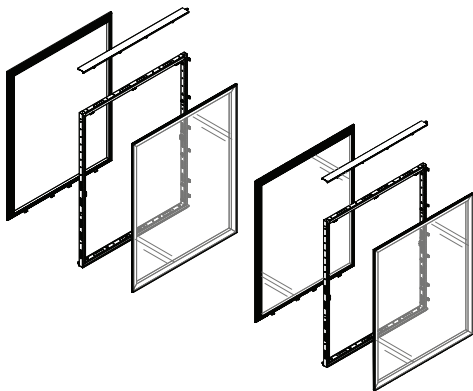

Elevated Full-Height (D-Style) – Double Glass (MUNPEWDR) Windows

- Used in place of an Elevated Panel Wall (MUNPER)
- Available in widths up to 150cm for panel heights up to 135cm and widths up to 120cm for panel heights up to 165cm
- Available in Standard Glass Clear and Frost
- Standard Glass, Clear is a tempered glass; Standard Glass, Frost is a etched tempered glass
- Frames are available in Espresso, Clear Anodized and Storm White paint finishes

panel walls

MUNPFR

Flush Panel Wall



26

The Flush Panel Wall is flush to the floor when finished.

WHAT'S INCLUDED

1 frame (widths 60cm-150cm) or 2 frames (widths over 150cm), hardware for straight connections, levelers.

WHAT'S EXCLUDED

Fascia applied to base must be specified separately.

NOTES

Top trim is optional (not needed when window is applied to top of panel or requires unique trim when centre mount storage is specified).

Panel wall frame has a Black finish.

Height	Width	Panel Frame
075, 105, 120, 135, 150, 165	06, 08, 09, 10, 12, 14, 15, 16, 18, 20, 24	Bare Frame

SAMPLE ORDER CODE

MUNPFR 120	06	Panel Matrix
------------	----	--------------

DIMENSIONS CM

H	W
075 / 74	06 / 60
075 / 74	08 / 80
075 / 74	09 / 90
075 / 74	10 / 100
075 / 74	12 / 120
075 / 74	14 / 140
075 / 74	15 / 150
075 / 74	16 / 160
075 / 74	18 / 180
075 / 74	20 / 200
075 / 74	24 / 240
105 / 104	06 / 60
105 / 104	08 / 80
105 / 104	09 / 90
105 / 104	10 / 100
105 / 104	12 / 120
105 / 104	14 / 140
105 / 104	15 / 150
105 / 104	16 / 160
105 / 104	18 / 180
105 / 104	20 / 200
105 / 104	24 / 240

PRICING

223
234
236
276
280
296
302
467
469
519
562
238
248
253
297
302
317
323
503
506
584
603

DIMENSIONS CM

H	W
120 / 119	06 / 60
120 / 119	08 / 80
120 / 119	09 / 90
120 / 119	10 / 100
120 / 119	12 / 120
120 / 119	14 / 140
120 / 119	15 / 150
120 / 119	16 / 160
120 / 119	18 / 180
120 / 119	20 / 200
120 / 119	24 / 240
135 / 134	06 / 60
135 / 134	08 / 80
135 / 134	09 / 90
135 / 134	10 / 100
135 / 134	12 / 120
135 / 134	14 / 140
135 / 134	15 / 150
135 / 134	16 / 160
135 / 134	18 / 180
135 / 134	20 / 200
135 / 134	24 / 240

PRICING

301
315
317
362
375
394
400
633
635
723
748
314
329
338
376
388
407
413
660
671
717
775

M U N P F R
Flush Panel Wal
(Continued)

DIMENSIONS
CM

PRICING

H	W	
150 / 149	06 / 60	326
150 / 149	08 / 80	343
150 / 149	09 / 90	359
150 / 149	10 / 100	390
150 / 149	12 / 120	401
150 / 149	14 / 140	420
150 / 149	15 / 150	426
150 / 149	16 / 160	687
150 / 149	18 / 180	707
150 / 149	20 / 200	744
150 / 149	24 / 240	800
165 / 165	06 / 60	339
165 / 165	08 / 80	357
165 / 165	09 / 90	380
165 / 165	10 / 100	403
165 / 165	12 / 120	414
165 / 165	14 / 140	432
165 / 165	15 / 150	439
165 / 165	16 / 160	713
165 / 165	18 / 180	742
165 / 165	20 / 200	771
165 / 165	24 / 240	827

panel walls

M U A F F R

Flush Panel with Accessory Beam

The Flush Panel Wall with an Accessory Beam is flush to the floor when finished.

WHAT'S INCLUDED

1 frame (widths 60cm - 150cm or 2 frames (widths over 150cm), accessory beam, hardware for straight connections, levelers.

NOTES

Accessory beam is integrated into the panel. Panel wall frame has a Black finish.

Total height of panel with Accessory Beam is 75cm and therefore requires fascias to be 2.5cm shorter.

28

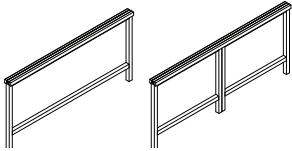

PRODUCT OPTIONS

Height	Width	Accessory Beam Finish	Panel Type
075	06, 08, 09, 10, 12, 14, 15, 16, 18 ,20 ,24	Foundation Mica AC Anodized	Bare Frame

SAMPLE ORDER CODE

MUAFFR 075	06	Q	Panel Matrix
------------	----	---	--------------

DIMENSIONS CM

H	W
075 / 74	06 / 60
075 / 74	08 / 80
075 / 74	09 / 90
075 / 74	10 / 100
075 / 74	12 / 120
075 / 74	14 / 140
075 / 74	15 / 150
075 / 74	16 / 160
075 / 74	18 / 180
075 / 74	20 / 200
075 / 74	24 / 240

PRICING

314
331
347
400
414
441
457
637
651
755
786

MUNPER

Elevated Panel Wall

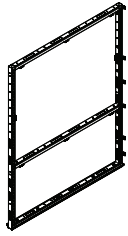

The Elevated Panel Wall provides 15cm high opening from floor level at the base when finished with legs.

WHAT'S INCLUDED

1 frame (widths 60cm-150cm) or 2 frames (widths over 150cm), hardware for straight connections, base trim with hardware for attachment.

WHAT'S EXCLUDED

Elevated Panel Wall Foot (MUNPEFR) must be ordered separately. Can be found on page 46.

NOTES

Top trim is optional (not needed when window is applied to top of panel or requires unique trim when centre mount storage is specified).

Panel wall frame has a Black finish.

PRODUCT OPTIONS

Height	Width	Base Trim Finish	Panel Type
075, 105, 120, 135, 150, 165	06, 08, 09, 10, 12, 14, 15, 16, 18, 20, 24	Foundation Mica (AC) Clear Anodized	Bare Frame

SAMPLE ORDER CODE

MUNPER 120	06	Q	Panel Matrix
------------	----	---	--------------

**DIMENSIONS
CM**

H	W
075 / 74	06 / 60
075 / 74	08 / 80
075 / 74	09 / 90
075 / 74	10 / 100
075 / 74	12 / 120
075 / 74	14 / 140
075 / 74	15 / 150
075 / 74	16 / 160
075 / 74	18 / 180
075 / 74	20 / 200
075 / 74	24 / 240
105 / 104	06 / 60
105 / 104	08 / 80
105 / 104	09 / 90
105 / 104	10 / 100
105 / 104	12 / 120
105 / 104	14 / 140
105 / 104	15 / 150
105 / 104	16 / 160
105 / 104	18 / 180
105 / 104	20 / 200
105 / 104	24 / 240

PRICING

241
255
264
307
317
337
348
521
527
573
633
257
271
282
327
337
358
367
556
562
640
675

**DIMENSIONS
CM**

H	W
120 / 119	06 / 60
120 / 119	08 / 80
120 / 119	09 / 90
120 / 119	10 / 100
120 / 119	12 / 120
120 / 119	14 / 140
120 / 119	15 / 150
120 / 119	16 / 160
120 / 119	18 / 180
120 / 119	20 / 200
120 / 119	24 / 240
135 / 134	06 / 60
135 / 134	08 / 80
135 / 134	09 / 90
135 / 134	10 / 100
135 / 134	12 / 120
135 / 134	14 / 140
135 / 134	15 / 150
135 / 134	16 / 160
135 / 134	18 / 180
135 / 134	20 / 200
135 / 134	24 / 240

PRICING

320
337
346
392
410
435
445
685
692
745
821
333
353
359
406
423
448
458
713
719
772
845

M U N P E R
Elevated Panel Wall
(Continued)

DIMENSIONS CM		PRICING
H	W	
150 / 149	06 / 60	346
150 / 149	08 / 80	369
150 / 149	09 / 90	372
150 / 149	10 / 100	420
150 / 149	12 / 120	437
150 / 149	14 / 140	461
150 / 149	15 / 150	472
150 / 149	16 / 160	740
150 / 149	18 / 180	744
150 / 149	20 / 200	799
150 / 149	24 / 240	871
165 / 165	06 / 60	358
165 / 165	08 / 80	378
165 / 165	09 / 90	385
165 / 165	10 / 100	434
165 / 165	12 / 120	450
165 / 165	14 / 140	473
165 / 165	15 / 150	485
165 / 165	16 / 160	767
165 / 165	18 / 180	771
165 / 165	20 / 200	826
165 / 165	24 / 240	897

panel walls

M U A F E R

Elevated Panel with Accessory Beam

The Elevated Panel Wall with an Accessory Beam provides a 15cm high opening from floor level at the base when finished with legs.

WHAT'S INCLUDED

1 frame (widths 60cm - 150cm) or 2 frames (widths over 120cm), accessory beam, hardware for straight connections, base trim with hardware for attachment.

NOTES

Accessory beam is integrated into the panel.

Panel wall frame has a Black finish.

Total height of panel with Accessory Beam is 75cm and therefore requires fascias to be 2.5cm shorter.

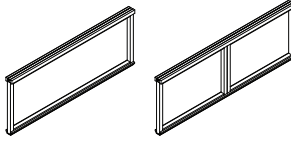

32

PRODUCT OPTIONS

Height	Width	Base Trim Finish	Accessory Beam Finish	Panel Type
075	06, 08, 09, 10, 12, 14, 15, 16, 18, 20, 24	Foundation Mica (AC) Clear Anodized	Foundation Mica (AC) Clear Anodized	Bare Frame

SAMPLE ORDER CODE

MUA FER 75	06	AC	Q	Panel Matrix
------------	----	----	---	--------------

DIMENSIONS CM

H	W
075 / 74	06 / 60
075 / 74	08 / 80
075 / 74	09 / 90
075 / 74	10 / 100
075 / 74	12 / 120
075 / 74	14 / 140
075 / 74	15 / 150
075 / 74	16 / 160
075 / 74	18 / 180
075 / 74	20 / 200
075 / 74	24 / 240

PRICING

332
352
375
431
450
482
503
690
709
767
857

MUNPC

Convertible Panel Wall

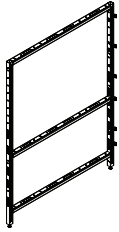

34

The Convertible Panel Wall frame can be used in flush-to-the-floor applications or in elevated applications by adding the Convertible Panel Wall Base and Foot Trim (MUNPCF).

WHAT'S INCLUDED

1 frame (widths 60cm-150cm) or 2 frames (widths over 150cm), hardware for straight connections, levelers.

WHAT'S EXCLUDED

Wall Base and Foot Trim (MUNPCF) must be specified separately. Can be found on page 45

NOTES

Top trim is optional (not needed when window is applied to top of panel or requires unique trim when centre mount storage is specified).

Panel wall frame has a Black finish.

PRODUCT OPTIONS

Height	Width	Panel Type
075, 105, 120, 135, 150, 165	06, 08, 09, 10, 12, 14, 15, 16, 18, 20, 24	Bare Frame

SAMPLE ORDER CODE

MUNPC 120	06	PANEL MATRIX
-----------	----	--------------

DIMENSIONS CM

H	W
075 / 74	06 / 60
075 / 74	08 / 80
075 / 74	09 / 90
075 / 74	10 / 100
075 / 74	12 / 120
075 / 74	14 / 140
075 / 74	15 / 150
075 / 74	16 / 160
075 / 74	18 / 180
075 / 74	20 / 200
075 / 74	24 / 240
105 / 104	06 / 60
105 / 104	08 / 80
105 / 104	09 / 90
105 / 104	10 / 100
105 / 104	12 / 120
105 / 104	14 / 140
105 / 104	15 / 150
105 / 104	16 / 160
105 / 104	18 / 180
105 / 104	20 / 200
105 / 104	24 / 240

PRICING

208
218
220
255
259
274
280
438
440
514
519
216
227
232
264
269
284
289
460
462
532
538

DIMENSIONS CM

H	W
120 / 119	06 / 60
120 / 119	08 / 80
120 / 119	09 / 90
120 / 119	10 / 100
120 / 119	12 / 120
120 / 119	14 / 140
120 / 119	15 / 150
120 / 119	16 / 160
120 / 119	18 / 180
120 / 119	20 / 200
120 / 119	24 / 240
135 / 134	06 / 60
135 / 134	08 / 80
135 / 134	09 / 90
135 / 134	10 / 100
135 / 134	12 / 120
135 / 134	14 / 140
135 / 134	15 / 150
135 / 134	16 / 160
135 / 134	18 / 180
135 / 134	20 / 200
135 / 134	24 / 240

PRICING

279
294
296
329
342
361
366
589
591
624
683
290
305
308
341
353
371
377
611
613
646
704

M U N P C
 Convertible Panel Wall
 (Continued)

DIMENSIONS
 CM

H	W
150 / 149	06 / 60
150 / 149	08 / 80
150 / 149	09 / 90
150 / 149	10 / 100
150 / 149	12 / 120
150 / 149	14 / 140
150 / 149	15 / 150
150 / 149	16 / 160
150 / 149	18 / 180
150 / 149	20 / 200
150 / 149	24 / 240
165 / 165	06 / 60
165 / 165	08 / 80
165 / 165	09 / 90
165 / 165	10 / 100
165 / 165	12 / 120
165 / 165	14 / 140
165 / 165	15 / 150
165 / 165	16 / 160
165 / 165	18 / 180
165 / 165	20 / 200
165 / 165	24 / 240

PRICING

301
317
319
351
364
382
388
632
634
668
725
311
328
328
363
374
392
400
654
655
691
746

panel walls

M U A F C R

Convertible Panel with Accessory Beam

The Convertible Panel with Accessory Beam can be used in flush-to-the-floor applications or in elevated applications by adding the Convertible Panel Wall Base and Foot Trim.

WHAT'S INCLUDED

1 frame (widths 60cm-150cm) or 2 frames (widths over 160cm), accessory beam, hardware for straight connections, base trim with hardware for attachment.

NOTES

Accessory beam is integrated into the panel. Panel wall frame has a Black finish.

Total height of panel with Accessory Beam is 75cm and therefore requires fascias to be 2.5cm shorter.

36

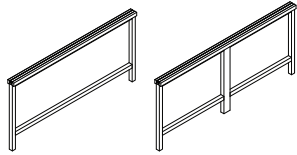

PRODUCT OPTIONS

Height	Width	Accessory Beam Finish	Panel Type
075	06, 08, 09, 10, 12, 14, 15, 16, 18, 20, 24	AC Clear Anodized Foundation Mica	Bare Frame

SAMPLE ORDER CODE

MUAFCR 75	06	Q	Panel Matrix
-----------	----	---	--------------

DIMENSIONS CM

H	W
075 / 74	06 / 60
075 / 74	08 / 80
075 / 74	09 / 90
075 / 74	10 / 100
075 / 74	12 / 120
075 / 74	14 / 140
075 / 74	15 / 150
075 / 74	16 / 160
075 / 74	18 / 180
075 / 74	20 / 200
075 / 74	24 / 240

PRICING

299
316
331
378
392
419
436
504
587
669
742

panel walls

MUNPLD

Add-On Window (L-Style)– Double Glass

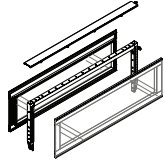

The Add-On Window – Double Glass (L-Style) is applied on top of panel walls as an add-on providing uninterrupted glass spans of up to 240cm in width.

WHAT'S INCLUDED

Structural frame, framed window insert, hardware for attachment, top trim (if specified).

NOTES

Standard Glass, Clear is a clear tempered glass.

Standard Glass, Frost is a etched tempered glass.

38

PRODUCT OPTIONS

Height	Width	Glass	Frame Finish	Top Trim	Top Trim Finish (If applicable)
030, 045, 060, 075, 090	06, 08, 09, 10, 12, 14, 15, 16, 18, 20, 24	5 Clear Standard Glass	Foundation	0 No Top Trim	Foundation Mica
		6 Frost Standard Glass	Mica	1 With Top Trim	

SAMPLE ORDER CODE

MUNPLD 030	06	6	Q	1	Q
------------	----	---	---	---	---

DIMENSIONS CM

PRICING

H	W	NO TOP TRIM (0)		WITH TOP TRIM (1)	
		Standard Glass Clear	Standard Glass Frost	Standard Glass Clear	Standard Glass Frost
030 / 30	06 / 60	452	465	499	512
030 / 30	08 / 80	497	514	547	564
030 / 30	09 / 90	543	562	600	619
030 / 30	10 / 100	598	621	661	684
030 / 30	12 / 120	652	680	720	748
030 / 30	14 / 140	694	726	769	801
030 / 30	15 / 150	747	779	827	859
030 / 30	16 / 160	819	855	906	942
030 / 30	18 / 180	865	907	958	1000
030 / 30	20 / 200	909	952	1008	1051
030 / 30	24 / 240	1072	1127	1187	1242
045 / 45	06 / 60	500	521	547	568
045 / 45	08 / 80	550	575	600	625
045 / 45	09 / 90	598	628	655	685
045 / 45	10 / 100	671	706	734	769
045 / 45	12 / 120	726	765	794	833
045 / 45	14 / 140	777	823	852	898
045 / 45	15 / 150	827	877	907	957
045 / 45	16 / 160	884	939	971	1026
045 / 45	18 / 180	932	992	1025	1085
045 / 45	20 / 200	979	1043	1078	1142
045 / 45	24 / 240	1169	1249	1284	1364

Pricing is continued on the following page

MUNPLD Add-On Window (L-Style)- Double Glass (Continued)

DIMENSIONS CM

H	W
060 / 60	06 / 60
060 / 60	08 / 80
060 / 60	09 / 90
060 / 60	10 / 100
060 / 60	12 / 120
060 / 60	14 / 140
060 / 60	15 / 150
060 / 60	16 / 160
060 / 60	18 / 180
060 / 60	20 / 200
060 / 60	24 / 240
075 / 75	06 / 60
075 / 75	08 / 80
075 / 75	09 / 90
075 / 75	10 / 100
075 / 75	12 / 120
075 / 75	14 / 140
075 / 75	15 / 150
075 / 75	16 / 160
075 / 75	18 / 180
075 / 75	20 / 200
075 / 75	24 / 240
090 / 90	06 / 60
090 / 90	08 / 80
090 / 90	09 / 90
090 / 90	10 / 100
090 / 90	12 / 120
090 / 90	14 / 140
090 / 90	15 / 150
090 / 90	16 / 160
090 / 90	18 / 180
090 / 90	20 / 200
090 / 90	24 / 240

PRICING

NO TOP TRIM (0)		WITH TOP TRIM (1)	
Standard Glass Clear	Frost	Standard Glass Clear	Frost
508	529	555	576
555	583	605	633
603	637	660	694
675	713	738	776
731	773	799	841
785	833	860	908
832	887	912	967
890	950	977	1037
939	1005	1032	1098
985	1057	1084	1156
1176	1264	1291	1379
572	596	625	649
625	656	682	713
679	717	744	782
760	803	831	874
823	870	900	947
884	938	969	1023
936	998	1026	1088
1002	1069	1100	1167
1057	1131	1162	1236
1109	1190	1221	1302
1323	1422	1453	1552
634	669	681	716
693	736	743	786
755	804	812	861
854	914	917	977
923	992	991	1060
986	1065	1061	1140
1048	1134	1128	1214
1120	1214	1207	1301
1181	1284	1274	1377
1241	1352	1340	1451
1470	1608	1585	1723

panel walls

MUNPFWDR

Flush Full-Height Window (D-Style) – Double Glass

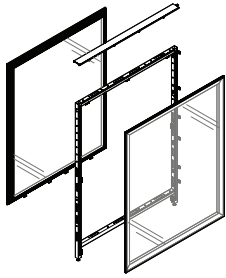

40

The Flush Full-Height Window (D-Style) – Double Glass provides uninterrupted vertical glass spans above the base rail.

WHAT'S INCLUDED

Structural frame, framed window insert, hardware for straight connections, levelers, top trim (if specified).

WHAT'S EXCLUDED

Fascia applied to base must be specified separately.

NOTES

The 165cm height is available up to 120cm in width only.

Standard Glass, Clear is a clear tempered glass.

Standard Glass, Frost is a etched tempered glass.

PRODUCT OPTIONS

Height	Width	Glass Finish	Frame Finish	Top Trim	Top Trim Finish (If applicable)
075, 105, 120, 135, 150, 165	06, 08, 09, 10, 12, 14, 15	5 Clear Standard Glass	BP Espresso Painted	0 No Top Trim	Foundation Mica (AC) Clear Anodized
		6 Frost Standard Glass	BH Storm White Painted	1 With Top Trim	
			AC Clear Anodized		

SAMPLE ORDER CODE

MUNPFWDR 120	06	6	BH	1	AC
--------------	----	---	----	---	----

DIMENSIONS CM

H	W
075 / 75	06 / 60
075 / 75	08 / 80
075 / 75	09 / 90
075 / 75	10 / 100
075 / 75	12 / 120
075 / 75	14 / 140
075 / 75	15 / 150
105 / 105	06 / 60
105 / 105	08 / 80
105 / 105	09 / 90
105 / 105	10 / 100
105 / 105	12 / 120
105 / 105	14 / 140
105 / 105	15 / 150
120 / 120	06 / 60
120 / 120	08 / 80
120 / 120	09 / 90
120 / 120	10 / 100
120 / 120	12 / 120
120 / 120	14 / 140
120 / 120	15 / 150

PRICING

NO TOP TRIM (0)

Standard	Glass
Clear	Frost
1061	1114
1146	1204
1232	1294
1326	1393
1413	1483
1522	1598
1628	1710
1262	1350
1366	1461
1468	1570
1584	1693
1686	1804
1673	1788
1866	1997
1510	1631
1634	1766
1761	1900
1901	2053
2028	2190
2145	2316
2257	2438

WITH TOP TRIM (1)

Standard	Glass
Clear	Frost
1108	1161
1196	1254
1289	1351
1389	1456
1481	1551
1597	1673
1708	1790
1309	1397
1416	1511
1525	1627
1647	1756
1754	1872
1748	1863
1946	2077
1557	1678
1684	1816
1818	1957
1964	216
2096	2258
2220	2391
2337	2518

M U N P F W D R
 Flush Full-Height Window
 (D-Style) – Double Glass
 (Continued)

DIMENSIONS
 CM

PRICING

DIMENSIONS		PRICING			
CM		NO TOP TRIM (0)		WITH TOP TRIM (1)	
H	W	Standard	Glass	Standard	Glass
		Clear	Frost	Clear	Frost
135 / 135	06 / 60	1510	1631	1557	1678
135 / 135	08 / 80	1634	1766	1684	1816
135 / 135	09 / 90	1761	1900	1818	1957
135 / 135	10 / 100	1901	2053	1964	2116
135 / 135	12 / 120	2028	2190	2096	2258
135 / 135	14 / 140	2145	2316	2220	2391
135 / 135	15 / 150	2257	2438	2337	2518
150 / 150	06 / 60	1691	1827	1738	1874
150 / 150	08 / 80	1845	1993	1895	2043
150 / 150	09 / 90	2000	2160	2057	2217
150 / 150	10 / 100	2178	2353	2241	2416
150 / 150	12 / 120	2333	2519	2401	2587
150 / 150	14 / 140	2251	2422	2326	2497
150 / 150	15 / 150	2476	2664	2556	2744
165 / 165	06 / 60	1691	1827	1738	1874
165 / 165	08 / 80	1845	1993	1895	2043
165 / 165	09 / 90	2000	2160	2057	2217
165 / 165	10 / 100	2178	2353	2241	2416
165 / 165	12 / 120	2333	2519	2401	2587

panel walls

MUNPEWDR

Elevated Full-Height Window (D-Style) – Double Glass

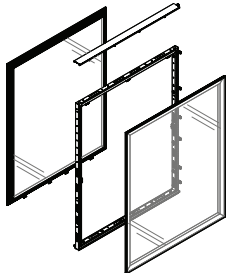

The Elevated Full-Height Window – Double Glass provides uninterrupted vertical glass spans above the base rail.

WHAT'S INCLUDED

Structural frame, framed window insert, hardware for straight connections, base trim with hardware for attachment, top trim (if specified).

WHAT'S EXCLUDED

Elevated Panel Wall Foot (MUNPEFR) must be ordered separately. Can be found on page 46

NOTES

The 165cm height is available up to 120cm in width only.

Standard Glass is a clear tempered glass finish.

Standard Glass, Frost is a etched tempered glass.

42

PRODUCT OPTIONS

Height 1	Width 2	Glass 1	Frame Finish	Base Trim Finish	Top Trim	Top Trim Finish (If applicable)
075, 105, 120, 135, 150, 165	06, 08, 09, 10, 12, 14, 15	5 Clear Standard Glass	BP Espresso Painted	AC Clear Anodized	0 No Top Trim	Foundation
		6 Frost Standard Glass	BH Storm White Painted AC Anodized	Foundation Mica	1 With Top Trim	Mica (AC) Clear Anodized

SAMPLE ORDER CODE

MUNPEWDR 120	06	6	BH	AC	1	Q
--------------	----	---	----	----	---	---

DIMENSIONS CM

PRICING

H	W	NO TOP TRIM (0)		WITH TOP TRIM (1)	
		Standard	Glass	Standard	Glass
075 / 75	06 / 60	1086	1140	1113	1187
075 / 75	08 / 80	1174	1232	1224	1282
075 / 75	09 / 90	1266	1328	1323	1385
075 / 75	10 / 100	1366	1432	1429	1495
075 / 75	12 / 120	1458	1529	1526	1597
075 / 75	14 / 140	1573	1650	1648	1725
075 / 75	15 / 150	1684	1766	1764	1846
105 / 105	06 / 60	1288	1376	1335	1423
105 / 105	08 / 80	1394	1489	1444	1539
105 / 105	09 / 90	1502	1604	1559	1661
105 / 105	10 / 100	1623	1734	1686	1797
105 / 105	12 / 120	1732	1849	1800	1917
105 / 105	14 / 140	1723	1840	1798	1915
105 / 105	15 / 150	1922	2052	2002	2132
120 / 120	06 / 60	1536	1657	1583	1704
120 / 120	08 / 80	1662	1794	1712	1844
120 / 120	09 / 90	1795	1934	1852	1991
120 / 120	10 / 100	1941	2093	2004	2156
120 / 120	12 / 120	2073	2235	2141	2303
120 / 120	14 / 140	2196	2367	2271	2442
120 / 120	15 / 150	2313	2493	2393	2573

M U N P E W D R
 Elevated Full-Height Window
 (D-Style) – Double Glass
 (Continued)

DIMENSIONS
 CM

PRICING

DIMENSIONS CM		NO TOP TRIM (0)		WITH TOP TRIM (1)	
		Standard	Glass	Standard	Glass
H	W	Clear	Frost	Clear	Frost
135 / 135	06 / 60	1597	1723	1644	1770
135 / 135	08 / 80	1733	1870	1783	1920
135 / 135	09 / 90	1875	2021	1932	2078
135 / 135	10 / 100	2033	2193	2096	2256
135 / 135	12 / 120	2175	2345	2243	2413
135 / 135	14 / 140	2393	2580	2468	2655
135 / 135	15 / 150	2632	2837	2712	2917
150 / 150	06 / 60	1657	1788	1704	1835
150 / 150	08 / 80	1803	1946	1853	1996
150 / 150	09 / 90	1955	2108	2012	2165
150 / 150	10 / 100	2125	2293	2188	2356
150 / 150	12 / 120	2277	2455	2345	2523
150 / 150	14 / 140	2505	2701	2580	2776
150 / 150	15 / 150	2755	2971	2835	3051
165 / 165	06 / 60	1717	1853	1764	1900
165 / 165	08 / 80	1873	2021	1923	2071
165 / 165	09 / 90	2034	2194	2091	2251
165 / 165	10 / 100	2217	2392	2280	2455
165 / 165	12 / 120	2378	2565	2446	2633

panel walls

MUNPCF

Convertible Panel Wall Base and Foot Trim

The Convertible Panel Wall Base and Foot Trim is used with Convertible Panel Walls to finish elevated applications.

WHAT'S INCLUDED

1 base trim and trim for 60cm (150cm and less)

2 base trims and trims for 120cm feet (165cm and wider)

44

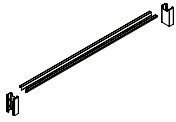

PRODUCT OPTIONS

Width	Foot Finish
06, 08, 09, 10, 12, 14, 15, 16, 18, 20, 24	Foundation Mica

SAMPLE ORDER CODE

MUNPCF 06	Q
-----------	---

DIMENSIONS

CM	PRICING
W	
06 / 60	61
08 / 80	63
09 / 90	66
10 / 100	69
12 / 120	73
14 / 140	80
15 / 150	83
16 / 160	130
18 / 180	132
20 / 200	137
24 / 240	148

MUNPEFR

Elevated Panel Wall Foot

The Elevated Panel Wall Foot provides support with leveling capability to Elevated Panel Walls and Elevated Full-Height Windows.

WHAT'S INCLUDED

1 foot, leveler, hardware for connection.

NOTES

The Elevated Panel Wall Foot is used in two-way 180° (no spacer), end of panel wall run applications or when added support is required for 165cm-240cm panels.

46



PRODUCT OPTIONS

Foot Finish

Foundation

Mica

(AC) Clear Anodized

SAMPLE ORDER CODE

MUNPEFR AC

PRICING

61

M U A F F N

Support Foot for Freestanding District

The Support Foot is added to flush or convertible District panels to allow them to become freestanding.

WHAT'S INCLUDED

1 double-sided metal freestanding foot and panel attachment brackets.

NOTES

Freestanding Foot can be applied to both the Flush or Convertible Panels either with or without Accessory Beam.

The unique element program required when foot is added. See Application Guide for more details.

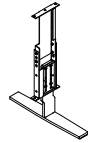

PRODUCT OPTIONS

Orientation	Foot Finish
D Double	Foundation Mica

SAMPLE ORDER CODE

MUAFFN D	Q
----------	---

PRICING

321

panel walls

MUNPHN Panel Wall Rail

The Panel Wall Rail provides horizontal support when additional segmentation is required above worksurface level.

WHAT'S INCLUDED

Panel wall rail, fascia clips and attachment hardware.

NOTES

Finished in Black to match the panel wall frame.

48

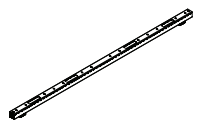

PRODUCT OPTIONS

Width
06, 08, 09, 10, 12, 14, 15, 16

SAMPLE ORDER CODE

MUNPHN 06

DIMENSIONS CM

W
06 / 60
08 / 80
09 / 90
10 / 100
12 / 120
14 / 140
15 / 150
16 / 160

PRICING

37
48
59
67
73
78
88
99

The Light Block Rail provides light block above the worksurface for fascias without clips.

WHAT'S INCLUDED
Rail and attachment hardware.

NOTES
Finished in Black to match the panel wall frame.

M U N E X Light Block Rail

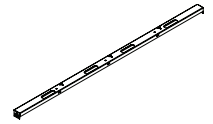

PRODUCT OPTIONS

Width
06, 08, 09, 10, 12, 14, 15

SAMPLE ORDER CODE

MUNEX 06

DIMENSIONS CM

PRICING

W	
06 / 60	31
08 / 80	38
09 / 90	49
10 / 100	56
12 / 120	63
14 / 140	72
15 / 150	82

fascias

fascias

PRODUCT MAP / TABLE OF CONTENTS	51
FASCIA OVERVIEW	54
FASCIA OVERVIEW FOR FREESTANDING DISTRICT	55
FASCIA BASICS	56
PRODUCT LISTING	60

product map

MUNESD Solid Fascia (Clip Mount)

Page 60
Height: 015cm, 30cm, 45cm, 57cm, 60cm, 72cm, 75cm, 90cm, Width: 60cm – 240cm

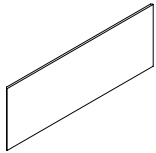

MUAESD Solid Fascia for Freestanding District (Clip Mount)

Page 62
Height: 15cm, 54cm, 57cm, 69cm, 72cm, 87cm & 103cm / Width: 60cm – 240cm

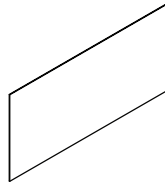

MUNESF Solid Fascia – Full-Height

Page 64
Height: 102cm
Width: 60cm – 240cm

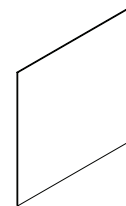

MUNELM Metal Fascia (Slot Mount)

Page 66
Height: 15cm, 30cm, 45cm, 57cm, 60cm, 72cm, 75cm, 90cm
Width: 60cm – 180cm

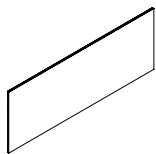

MUAELM Metal Fascia for Freestanding District (Slot Mount)

Page 68
Height: 15cm, 54cm, 57cm, 69cm, 72cm & 87cm
Width: 60cm – 180cm

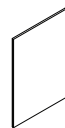

MUNELF Tackable Fabric Fascia (Slot Mount)

Page 70
Height: 15cm, 30cm, 45cm, 57cm, 60cm, 72cm, 75cm, 90cm,
Width: 60cm – 180cm

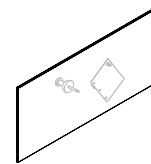

MUAELF Tackable Fabric Fascia for Freestanding District (Slot Mount)

Page 72
Height: 15cm, 54cm, 57cm, 69cm, 72cm, 87cm /
Width: 60cm – 180cm

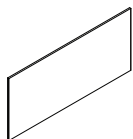

MUNEMB Whiteboard Fascia (Slot Mount)

Page 74
Height: 45cm, 60cm, 75cm & 90cm /
Width: 90cm – 120cm

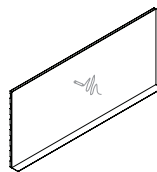

MUNELA Accessory Fascia (Slot Mount)

Page 75
Height: 15cm, 30cm & 45cm /
Width: 60cm – 180cm

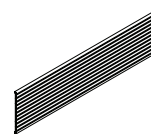

MUNELMB Metal Base Feed Fascia (Slot Mount)

Page 76
Height: 15cm / Width: 60cm – 180cm

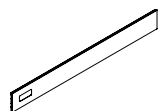

MUAELMB Metal Base Feed Fascia for Freestanding District (Slot Mount)

Page 77
Height: 15cm / Width: 60cm – 180cm



MUAELFB Fabric Base Feed Fascia for Freestanding District (Slot Mount)

Page 78
Height: 15cm / Width: 90cm – 180cm



MUNELWD Window (L-Style) –
Double Glass
(Slot Mount)

Page 79

Height: 30cm, 45cm, 60cm, 75cm, 90cm /
Width: 60cm – 150cm

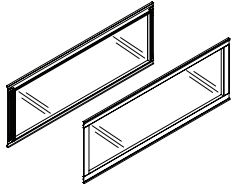

MUNELK Fascia Clip Kit

Page 80

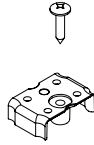

fascia overview

Fascias complete the elevations of panel walls to provide functionality and aesthetic options.

Fascia widths are available up to 240cm to span the entire width of District panels to create a distinctive District aesthetic or can be split to provide additional functionality to a workstation.

panel walls

54

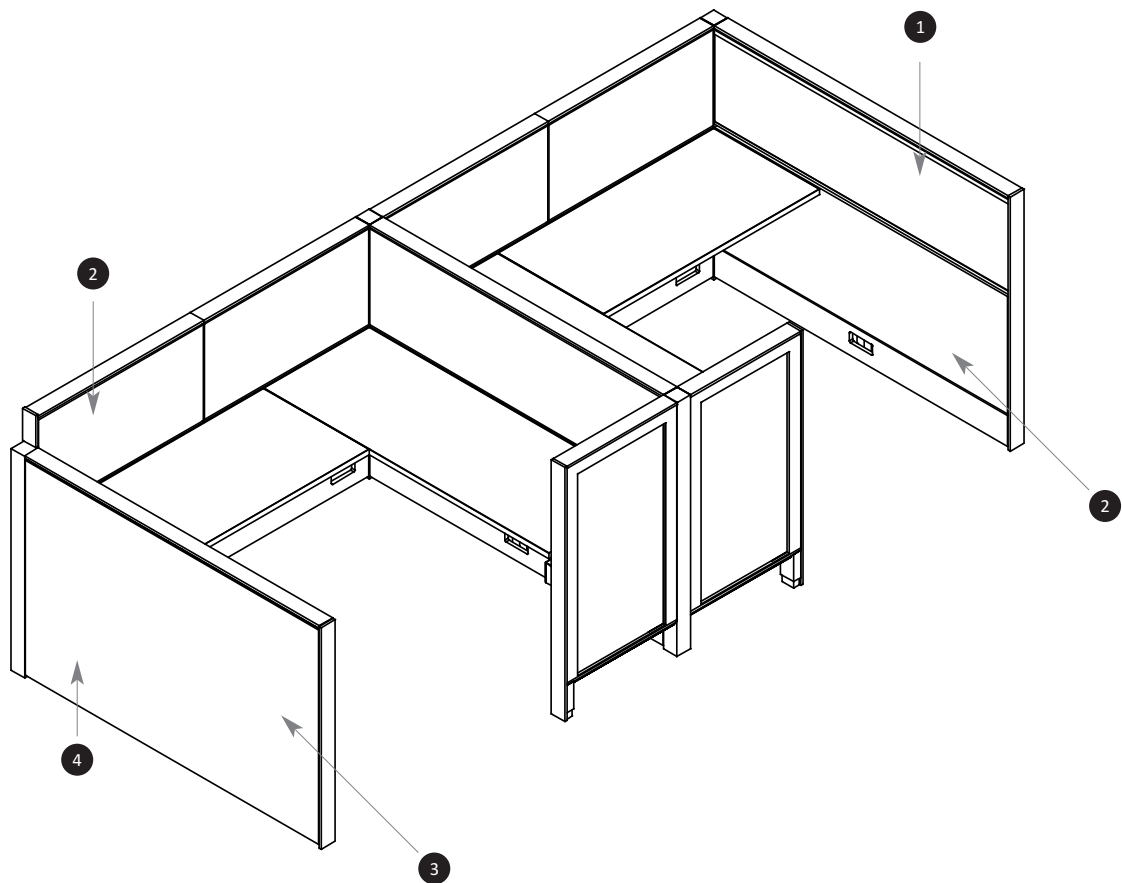

- 1 **Windows** can be used at various levels to add light to a workstation .
- 2 **Fabric and metal fascias** provide a cost effective alternative to solid fascias
- 3 **Solid fascias** are available in Laminate, to provide a high level of aesthetics and a furniture look and feel to a workstation
- 4 Fascias can be segmented from 75cm high or can be monolithic on 105cm high panels

fascia overview for freestanding district

freestanding

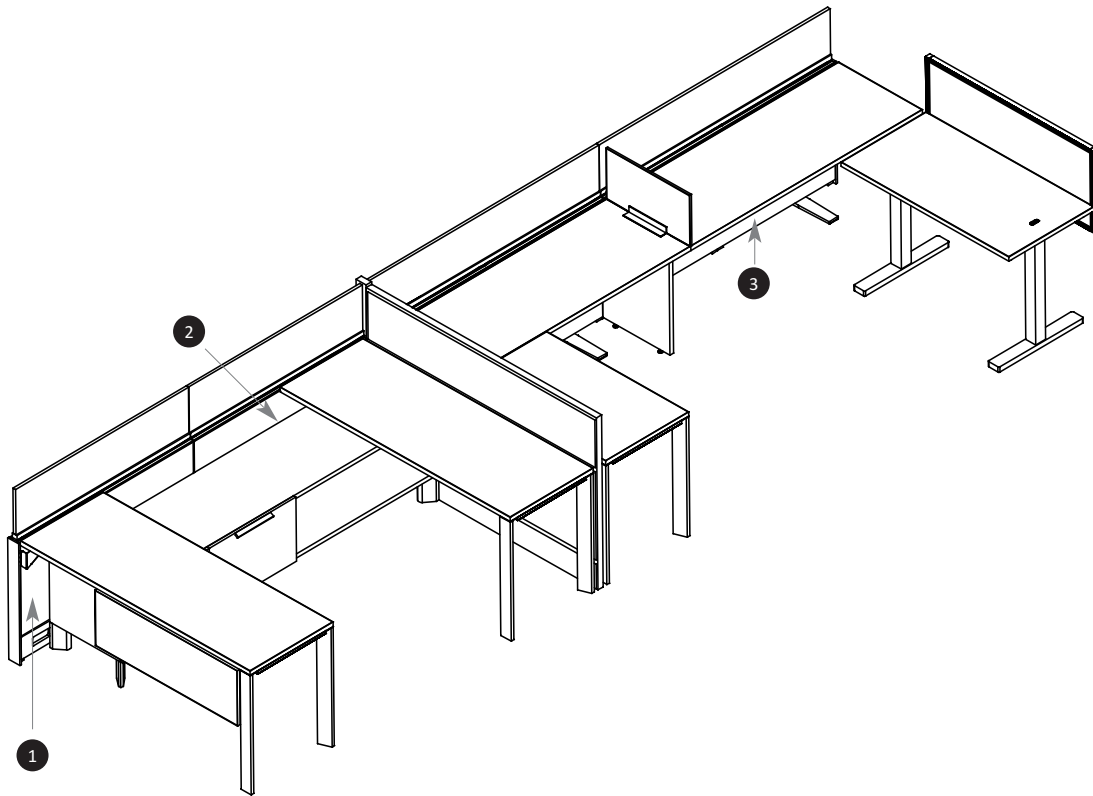

- 1 The Fascias for Freestanding District is used only for freestanding District. It is a different height than standard fascias to accommodate for the 1.25cm support foot. The Fascias for Freestanding District are nominal therefore the 75cm fascia will actually be 72cm
- 2 Fabric and Metal fascias provide a cost effective alternative to solid fascias.
- 3 Freestanding fascias are only required at the base level of the panel. MUN__ fascias will not fit

fascias basics

Fascias can be mounted onto panel walls through clip mounting or slot mounting. See chart below.

clip-mounted

- The following fascia types mount to the Flush and Elevated Panel Wall. They are typically hard surface finishes that provide a “District” aesthetic, where the fascias sit outside of the frame by mounting to the clips on the frame.
- These fascias can also mount to the Convertible Panel Wall, however a Fascia Clip Kit (MUNELK) is required to be install the fascia to the panel

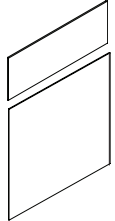
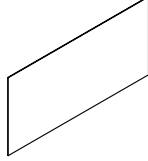
Product Name & Code	Illustration	Description
Solid Fascia (MUNESD) & Solid Full-Height Fascia (MUNESF)		<ul style="list-style-type: none"> • A solid fascia that mounts into a panel wall frame when no freestanding support foot is used • Solid Fascias are available in heights of 15cm, 30cm, 45cm, 57cm, 60cm, 72cm, 75cm, and 90cm for mounting above or below widths from 60cm to 240cm • Solid Full-Height Fascias are available in height of 102cm and widths from 60cm to 240cm for monolithic mounting on 105cm high panels only • Available in Laminate
Solid Fascia for Freestanding District (Clip Mounted) (MUAESD)		<ul style="list-style-type: none"> • A solid fascia that mounts into a panel wall frame when in freestanding applications using the support foot • Solid Fascias are available in heights of 15cm, 54cm, 57cm, 69cm, 72cm, 87cm and 102cm for mounting above or below widths from 60cm to 240cm • Available in Laminates • Only used with Support Foot (MUAFFN) • Sizes are nominal to accommodate 12cm for support foot • Should only be used at the base level

Fascias can be mounted onto panel walls through clip mounting or slot mounting. See chart below.

slot-mounted

- The following fascia types mount to the Convertible Panel Wall.
- These fascias can also mount to the Flush Panel Wall or the Elevated Panel Wall however, pre-installed clips will not be used. The fascias will mount into the slots in the panel frame only

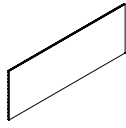
Product Name & Code	Illustration	Description
Metal Fascia (MUNELM)		<ul style="list-style-type: none"> • A cost effective alternative to solid fascia when no freestanding support foot is used • Available in heights of 15cm, 30cm, 45cm, 57cm, 60cm, 72cm, 75cm, 90cm, and widths from 60cm to 180cm • Available in Foundation and Mica paint finishes
Metal Fascia for Freestanding District (MUAELM)		<ul style="list-style-type: none"> • A cost effective alternative to solid fascia in freestanding applications when using the support foot • Available in heights of 15cm, 54cm, 57cm, 69cm, 72cm and 87cm and widths from 60cm to 180cm • Widths up to 180cm only can be specified for heights below 72cm • Available in Foundation and Mica paint finishes • Only used with Support Foot (MUAFFN) • Sizes are nominal to accommodate 120cm for support foot • Should only be used at the base level

fascia basics (continued)

Fascias can be mounted onto panel walls through clip mounting or slot mounting. See chart below.

slot-mounted

- The following fascia types mount to the Convertible Panel Wall. They provide a cost effective alternative to “D-Style” fascias and are unframed. They are also referred to as “L-Style” fascias
- These fascias can also mount to the Flush Panel Wall or the Elevated Panel Wall using slots in the panel frame

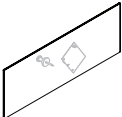
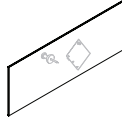
zProduct Name & Code	Illustration	Description
Tackable Fabric Fascia (MUNELF)		<ul style="list-style-type: none"> • A frameless cost effective fabric fascia for use above or below the worksurface when no freestanding support foot is used • Available in heights of 30cm, 45cm, 57cm, 60cm, 72cm, 75cm, 90cm, and widths from 60cm to 180cm • Tackable in all heights with the exception of the 15cm heights • Available in standard Teknion panel fabrics
Tackable Fabric Fascia for Freestanding District (Slot Mount) (MUAELF)		<ul style="list-style-type: none"> • A frameless cost effective fabric fascia for use above or below the worksurface in freestanding application when support foot is used • Available in heights of 15cm, 54cm, 57cm and 60cm, 72cm, 87cm and widths from 60cm to 180cm • Tackable in all heights with the exception of the 15cm heights • Available in standard Teknion panel fabrics • Only used with Support Foot (MUAFFN) • Sizes are nominal to accommodate 1.2cm for support foot • Should only be used at the base level

fascia basics (continued)

slot-mounted

- The following fascia types mount to the Convertible Panel Wall.
- These fascias can also mount to the Flush Panel Wall or the Elevated Panel Wall using slots in the panel frame

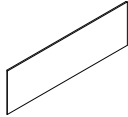
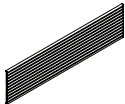
Product Name & Code	Illustration	Description
Whiteboard Fascia (MUNEMB)		<ul style="list-style-type: none"> • A frameless cost effective whiteboard fascia • Available in heights of 65cm, 60cm, 75cm and 90cm and widths from 90cm, 100cm and 120cm • Available with or without tray • Tray is available in Foundation and Mica paint finishes
Accessory Fascia (MUNELA)		<ul style="list-style-type: none"> • Available in heights of 15cm, 30cm and 45cm for maximum flexibility and widths from 60cm to 180cm • Available in Foundation and Mica paint finishes

58

Fascias can be mounted onto panel walls through clip mounting or slot mounting. See chart below.

slot-mounted

- The following fascia types mount to the Convertible Panel Wall.
- These fascias can also mount to the Flush Panel Wall or the Elevated Panel Wall using slots in the panel frame

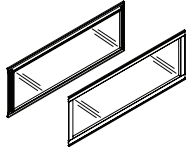
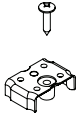
Product Name & Code	Illustration	Description
Window (L-Style) – Double Glass (MUNELWD) (shown)		<ul style="list-style-type: none"> • Double-sided glass fascias that mounts into a panel wall frame • Available in heights of 30cm, 45cm, 60cm, 75cm, 90cm and widths from 60cm to 150cm as it fits inside the frame of a panel wall – panels over 150cm wide consist of two frames • Available in Standard Glass Clear and Frost • Standard Glass, Clear is a tempered glass; Standard Glass, Frost is etched tempered glass • Frames are available in Foundation and Mica paint finishes
Fascia Clip Kit (MUNELK)		<ul style="list-style-type: none"> • Required to apply clip-mounted fascias to the Convertible Frame (MUNPC) • Clips are mounted to the frame and the quantity required varies by size (see chart below) • Kits are available in packages of 25 or 100

fascia basics (continued)

Panel Height	Panel Width	Number of Clips	
		Flush	Elevated
75	60	4	2
75	75	4	2
75	90	4	2
75	105	6	3
75	120	6	3
75	135	6	3
75	150	6	3
75	165	8	4
75	180	8	4
75	195	12	6
75	210	12	6
75	235	12	6
75	240	12	6
105	60	6	4
105	75	6	4
105	90	6	4
105	105	9	6
105	120	9	6
105	135	9	6
105	150	9	6
105	165	12	8
105	180	12	8
105	195	18	12
105	210	18	12
105	235	18	12
105	240	18	12

Panel Height	Panel Width	Number of Clips	
		Flush	Elevated
120	60	6	4
120	75	6	4
120	90	6	4
120	105	9	6
120	120	9	6
120	135	9	6
120	150	9	6
120	165	12	8
120	180	12	8
120	195	18	12
120	210	18	12
120	235	18	12
120	240	18	12
135	60	8	6
135	75	8	6
135	90	8	6
135	105	11	8
135	120	11	8
135	135	11	8
135	150	11	8
135	165	16	12
135	180	16	12
135	195	22	16
135	210	22	16
135	235	22	16
135	240	22	16

Panel Height	Panel Width	Number of Clips	
		Flush	Elevated
150	60	4	2
150	75	4	2
150	90	4	2
150	105	6	3
150	120	6	3
150	135	6	3
150	150	6	3
150	165	8	4
150	180	8	4
150	195	12	6
150	210	12	6
150	235	12	6
150	240	12	6

Panel Height	Panel Width	Number of Clips	
		Flush	Elevated
120	8	6	4
120	8	6	4
120	8	6	4
120	11	9	6
120	11	9	6
120	11	9	6
120	11	9	6
120	11	9	6
120	16	12	8
120	16	12	8
120	22	18	12
120	22	18	12
120	22	18	12
120	22	18	12

fascias

MUNESD

Solid Fascia (Clip Mount)

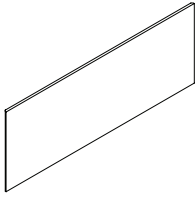

The Solid Fascia provides a solid panel wall finish above worksurface height.

WHAT'S INCLUDED

1 fascia, fascia connectors.

WHAT'S EXCLUDED

Panel Wall Rail (MUNPHN) is required for additional panel segmentation and must be specified separately. Can be found on page 48

72cm and 57cm height fascia can only be applied to the Flush Panel with Accessory Beam (MUAFFR), Elevated Panel with Accessory Beam or Convertible Panel with Accessory Beam (MUAFCR).

60

PRODUCT OPTIONS

Height	Width	Finish
015, 030, 045, 057, 060, 072, 075, 090	06, 08, 09, 10, 12, 14, 15, 16, 18, 20, 24	Source Laminate

SAMPLE ORDER CODE

MUNESD 090	06	R1
------------	----	----

**DIMENSIONS
CM**

PRICING

H	W	Source Laminate
015 / 15	06 / 60	94
015 / 15	08 / 80	96
015 / 15	09 / 90	99
015 / 15	10 / 100	105
015 / 15	12 / 120	108
015 / 15	14 / 140	109
015 / 15	15 / 150	112
015 / 15	16 / 160	121
015 / 15	18 / 180	123
015 / 15	20 / 200	126
015 / 15	24 / 240	137
030 / 30	06 / 60	102
030 / 30	08 / 80	108
030 / 30	09 / 90	113
030 / 30	10 / 100	120
030 / 30	12 / 120	127
030 / 30	14 / 140	132
030 / 30	15 / 150	137
030 / 30	16 / 160	145
030 / 30	18 / 180	151
030 / 30	20 / 200	157
030 / 30	24 / 240	185

**DIMENSIONS
INCHES / MM**

PRICING

H	W	Source Laminate
045 / 45	06 / 60	132
045 / 45	08 / 80	140
045 / 45	09 / 90	146
045 / 45	10 / 100	156
045 / 45	12 / 120	165
045 / 45	14 / 140	172
045 / 45	15 / 150	178
045 / 45	16 / 160	188
045 / 45	18 / 180	196
045 / 45	20 / 200	204
045 / 45	24 / 240	240
057 / 57	06 / 60	139
057 / 57	08 / 80	145
057 / 57	09 / 90	152
057 / 57	10 / 100	161
057 / 57	12 / 120	172
057 / 57	14 / 140	179
057 / 57	15 / 150	185
057 / 57	16 / 160	196
057 / 57	18 / 180	204
057 / 57	20 / 200	212
057 / 57	24 / 240	249

Pricing is continued on the following page.

MUNESD Solid Fascia (Clip Mount) (Continued)

DIMENSIONS CM		PRICING
H	W	Source Laminate
060 / 60	06 / 60	139
060 / 60	08 / 80	145
060 / 60	09 / 90	152
060 / 60	10 / 100	161
060 / 60	12 / 120	172
060 / 60	14 / 140	179
060 / 60	15 / 150	185
060 / 60	16 / 160	196
060 / 60	18 / 180	204
060 / 60	20 / 200	212
060 / 60	24 / 240	249
072 / 72	06 / 60	144
072 / 72	08 / 80	153
072 / 72	09 / 90	162
072 / 72	10 / 100	174
072 / 72	12 / 120	185
072 / 72	14 / 140	195
072 / 72	15 / 150	204
072 / 72	16 / 160	215
072 / 72	18 / 180	225
072 / 72	20 / 200	236
072 / 72	24 / 240	278

DIMENSIONS INCHES / MM		PRICING
H	W	Source Laminate
075 / 75	06 / 60	149
075 / 75	08 / 80	161
075 / 75	09 / 90	174
075 / 75	10 / 100	185
075 / 75	12 / 120	200
075 / 75	14 / 140	211
075 / 75	15 / 150	221
075 / 75	16 / 160	235
075 / 75	18 / 180	246
075 / 75	20 / 200	259
075 / 75	24 / 240	307
090 / 90	06 / 60	159
090 / 90	08 / 80	176
090 / 90	09 / 90	191
090 / 90	10 / 100	207
090 / 90	12 / 120	224
090 / 90	14 / 140	241
090 / 90	15 / 150	256
090 / 90	16 / 160	272
090 / 90	18 / 180	287
090 / 90	20 / 200	303
090 / 90	24 / 240	365

M U A E S D

Solid Fascia for Freestanding District (Clip Mount)

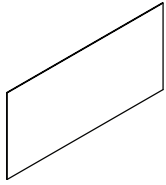

The Solid Fascia provides a solid panel wall finish on panel supported by the Freestanding Foot (MUAFFN).

WHAT'S INCLUDED
1 fascia, fascia connectors.

NOTES

Fascia is to only be applied to District Panel that is supported by the Freestanding Foot (MUAFFN).

The 54cm and 57cm fascias must be ordered with a 15cm high fascia as Elevated panels are not applicable in a freestanding application.

72cm height fascia can only be applied to the Flush Panel with Accessory Beam (MUAFFR), Elevated Panel with Accessory Beam or Convertible Panel with Accessory Beam (MUAFCR).

PRODUCT OPTIONS

Height	Width	Finish
015, 054, 057, 069, 072, 087	06, 08, 09, 10, 12, 14, 15, 16, 18, 20, 24	Source Laminate

SAMPLE ORDER CODE

MUAESD 057	06	R1
------------	----	----

**DIMENSIONS
CM**

PRICING

H	W	Source Laminate
015 / 15	06 / 60	94
015 / 15	08 / 80	96
015 / 15	09 / 90	99
015 / 15	10 / 100	105
015 / 15	12 / 120	108
015 / 15	14 / 140	109
015 / 15	15 / 150	112
015 / 15	16 / 160	121
015 / 15	18 / 180	123
015 / 15	20 / 200	126
015 / 15	24 / 240	137
054 / 54	06 / 60	98
054 / 54	08 / 80	100
054 / 54	09 / 90	102
054 / 54	10 / 100	110
054 / 54	12 / 120	112
054 / 54	14 / 140	113
054 / 54	15 / 150	116
054 / 54	16 / 160	126
054 / 54	18 / 180	128
054 / 54	20 / 200	130
054 / 54	24 / 240	143

**DIMENSIONS
INCHES / MM**

PRICING

H	W	Source Laminate
057 / 57	06 / 60	98
057 / 57	08 / 80	100
057 / 57	09 / 90	102
057 / 57	10 / 100	110
057 / 57	12 / 120	112
057 / 57	14 / 140	113
057 / 57	15 / 150	116
057 / 57	16 / 160	126
057 / 57	18 / 180	128
057 / 57	20 / 200	130
057 / 57	24 / 240	143
069 / 69	06 / 60	102
069 / 69	08 / 80	108
069 / 69	09 / 90	113
069 / 69	10 / 100	120
069 / 69	12 / 120	127
069 / 69	14 / 140	132
069 / 69	15 / 150	137
069 / 69	16 / 160	145
069 / 69	18 / 180	151
069 / 69	20 / 200	157
069 / 69	24 / 240	185

Pricing is continued on the following page.

M U A E S D

Solid Fascia for Freestanding District (Clip Mount) (Continued)

DIMENSIONS
CM

PRICING

H	W	Source Laminate
072 / 72	06 / 60	118
072 / 72	08 / 80	123
072 / 72	09 / 90	129
072 / 72	10 / 100	139
072 / 72	12 / 120	147
072 / 72	14 / 140	152
072 / 72	15 / 150	157
072 / 72	16 / 160	167
072 / 72	18 / 180	174
072 / 72	20 / 200	181
072 / 72	24 / 240	213
087 / 87	06 / 60	132
087 / 87	08 / 80	140
087 / 87	09 / 90	146
087 / 87	10 / 100	156
087 / 87	12 / 120	165
087 / 87	14 / 140	172
087 / 87	15 / 150	178
087 / 87	16 / 160	188
087 / 87	18 / 180	196
087 / 87	20 / 200	204
087 / 87	24 / 240	240

MUNESF

Solid Fascia – Full-Height

The Solid Fascia – Full-Height provides a solid monolithic look from the base of the panel to a height of 105cm.

WHAT'S INCLUDED
1 fascia with connectors.

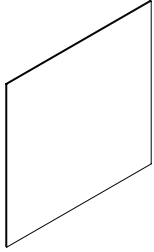

64

PRODUCT OPTIONS

Height	Width	Fascia Finish
102	06, 08, 09, 10, 12, 14, 15, 16, 18, 20, 24	Source Laminate

SAMPLE ORDER CODE

MUNESF 102	06	R1
------------	----	----

DIMENSIONS CM

PRICING

H	W	Source Laminate
102 / 102	06 / 60	173
102 / 102	08 / 80	197
102 / 102	09 / 90	219
102 / 102	10 / 100	238
102 / 102	12 / 120	261
102 / 102	14 / 140	285
102 / 102	15 / 150	306
102 / 102	16 / 160	326
102 / 102	18 / 180	348
102 / 102	20 / 200	371
102 / 102	24 / 240	447

fascias

M U N E L M

Metal Fascia (Slot Mount)

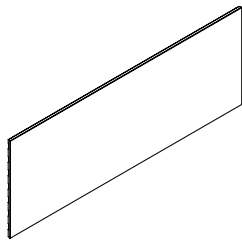

The Metal Fascia provides a metal panel wall finish.

WHAT'S INCLUDED

1 fascia and attachment hardware.

NOTES

75cm and 90cm heights can be specified to a maximum of 15cm width only.

72cm and 69cm height fascia can only be applied to the Flush Panel with Accessory Beam (MUAFFR), Elevated Panel with Accessory Beam or Convertible Panel with Accessory Beam (MUAFCR).

PRODUCT OPTIONS

Height	Width	Fascia Finish
015, 030, 045, 057, 060, 072, 075, 090	06, 08, 09, 10, 12, 14, 15, 16, 18	Foundation Mica

SAMPLE ORDER CODE

MUNELM 090	06	Q
------------	----	---

DIMENSIONS CM

PRICING

H	W	
015 / 15	06 / 60	29
015 / 15	08 / 80	33
015 / 15	09 / 90	37
015 / 15	10 / 100	42
015 / 15	12 / 120	48
015 / 15	14 / 140	59
015 / 15	15 / 150	69
015 / 15	16 / 160	81
015 / 15	18 / 180	91
030 / 30	06 / 60	36
030 / 30	08 / 80	42
030 / 30	09 / 90	52
030 / 30	10 / 100	61
030 / 30	12 / 120	65
030 / 30	14 / 140	81
030 / 30	15 / 150	90
030 / 30	16 / 160	101
030 / 30	18 / 180	114

DIMENSIONS CM

PRICING

H	W	
045 / 45	06 / 60	52
045 / 45	08 / 80	61
045 / 45	09 / 90	70
045 / 45	10 / 100	85
045 / 45	12 / 120	94
045 / 45	14 / 140	112
045 / 45	15 / 150	123
045 / 45	16 / 160	141
045 / 45	18 / 180	156
057 / 57	06 / 60	62
057 / 57	08 / 80	72
057 / 57	09 / 90	86
057 / 57	10 / 100	98
057 / 57	12 / 120	112
057 / 57	14 / 140	129
057 / 57	15 / 150	144
057 / 57	16 / 160	166
057 / 57	18 / 180	188

Pricing is continued on the following page.

M U N E L M

Metal Fascia (Slot Mount) (Continued)

DIMENSIONS		PRICING
CM		
H	W	
060 / 60	06 / 60	62
060 / 60	08 / 80	72
060 / 60	09 / 90	86
060 / 60	10 / 100	98
060 / 60	12 / 120	112
060 / 60	14 / 140	129
060 / 60	15 / 150	144
060 / 60	16 / 160	166
060 / 60	18 / 180	188
072 / 72	06 / 60	64
072 / 72	08 / 80	78
072 / 72	09 / 90	92
072 / 72	10 / 100	105
072 / 72	12 / 120	119
072 / 72	14 / 140	136
072 / 72	15 / 150	153
072 / 72	16 / 160	187
072 / 72	18 / 180	204

CM		PRICING
H	W	
075 / 75	06 / 60	65
075 / 75	08 / 80	79
075 / 75	09 / 90	94
075 / 75	10 / 100	109
075 / 75	12 / 120	122
075 / 75	14 / 140	140
075 / 75	15 / 150	157
090 / 90	06 / 60	86
090 / 90	08 / 80	98
090 / 90	09 / 90	118
090 / 90	10 / 100	134
090 / 90	12 / 120	152
090 / 90	14 / 140	185
090 / 90	15 / 150	217

M U A E L M

Metal Fascia for Freestanding District (Slot Mount)

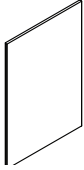

The Metal Fascia provides a metal panel wall finish.

WHAT'S INCLUDED
1 fascia and attachment hardware.

NOTES
Not all height/width combinations are available, 87cm heights can be specified to a maximum of 15cm width only. See pricing for exact offering.

Fascia is to only be applied to District Panel that is supported by the freestanding Foot (MUAFFN).

The 54cm and 57cm fascias must be ordered with a 15cm high fascia as Elevated panels are not applicable in a freestanding application.

72cm and 69cm height fascia can only be applied to the Flush Panel with Accessory Beam (MUAFFR), Elevated Panel with Accessory Beam or Convertible Panel with Accessory Beam (MUAFCR).

PRODUCT OPTIONS

Height	Width	Finish
015 ,0 54, 057, 069, 072 ,087	06 ,08, 09, 10, 12, 14, 15, 16, 18	Foundation Mica

SAMPLE ORDER CODE

MUAELM 057	06	Q
------------	----	---

DIMENSIONS CM

PRICING

H	W	
015 / 15	06 / 60	29
015 / 15	08 / 80	33
015 / 15	09 / 90	37
015 / 15	10 / 100	42
015 / 15	12 / 120	48
015 / 15	14 / 140	59
015 / 15	15 / 150	69
015 / 15	16 / 160	81
015 / 15	18 / 180	91
054 / 54	06 / 60	52
054 / 54	08 / 80	61
054 / 54	09 / 90	70
054 / 54	10 / 100	85
054 / 54	12 / 120	94
054 / 54	14 / 140	112
054 / 54	15 / 150	123
054 / 54	16 / 160	141
054 / 54	18 / 180	156

DIMENSIONS CM

PRICING

H	W	
057 / 57	06 / 60	52
057 / 57	08 / 80	61
057 / 57	09 / 90	70
057 / 57	10 / 100	85
057 / 57	12 / 120	94
057 / 57	14 / 140	112
057 / 57	15 / 150	123
057 / 57	16 / 160	141
057 / 57	18 / 180	156
069 / 69	06 / 60	64
069 / 69	08 / 80	78
069 / 69	09 / 90	92
069 / 69	10 / 100	105
069 / 69	12 / 120	119
069 / 69	14 / 140	136
069 / 69	15 / 150	153
069 / 69	16 / 160	187
069 / 69	18 / 180	204

Pricing is continued on the following page.

M U A E L M
 Metal Fascia for Freestanding
 District (Slot Mount) (Continued)

DIMENSIONS CM		PRICING
H	W	
072 / 72	06 / 60	64
072 / 72	08 / 80	78
072 / 72	09 / 90	92
072 / 72	10 / 100	105
072 / 72	12 / 120	119
072 / 72	14 / 140	136
072 / 72	15 / 150	153
072 / 72	16 / 160	187
072 / 72	18 / 180	204
087 / 87	06 / 60	86
087 / 87	08 / 80	98
087 / 87	09 / 90	112
087 / 87	10 / 100	129
087 / 87	12 / 120	144
087 / 87	14 / 140	166
087 / 87	15 / 150	188

MUNELF

Tackable Fabric Fascia (Slot Mount)

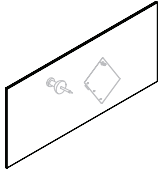

The Tackable Fabric Fascia provides a tackable panel wall finish.

WHAT'S INCLUDED

1 fascia.

WHAT'S EXCLUDED

Fascia Light Block (MUNEX) is required for additional segmentation and must be specified separately. Can be found on page 49

NOTES

15cm height fascias are not tackable.

Graded-In panel fabrics are available on products up to 150cm in width only.

72cm height fascia can only be applied to the Flush Panel with Accessory Beam (MUAFFR), Elevated Panel with Accessory Beam or Convertible Panel with Accessory Beam (MUAFCR).

PRODUCT OPTIONS

Height	Width	Fabric Finish
030, 045, 057, 060, 072, 075, 090	06, 08, 09, 10, 12, 14, 15, 16, 18	Grade COM Grade AA Grade A Grade 1

SAMPLE ORDER CODE

MUNELF 075	09	E324
------------	----	------

DIMENSIONS CM

PRICING

H	W	Fabric Gr.AA	Gr.A/COM	Gr.1
030/ 30	06 / 60	35	36	38
030/ 30	08 / 80	39	42	54
030/ 30	09 / 90	48	52	59
030/ 30	10 / 100	57	61	62
030/ 30	12 / 120	61	65	69
030/ 30	14 / 140	73	81	87
030/ 30	15 / 150	84	90	93
030/ 30	16 / 160	94	101	112
030/ 30	18 / 180	107	114	129

H	W	Fabric Gr.AA	Gr.A/COM	Gr.1
045/ 45	06 / 60	47	52	55
045/ 45	08 / 80	55	61	68
045/ 45	09 / 90	64	70	80
045/ 45	10 / 100	78	85	89
045/ 45	12 / 120	87	94	100
045/ 45	14 / 140	104	112	119
045/ 45	15 / 150	113	123	129
045/ 45	16 / 160	127	141	152
045/ 45	18 / 180	142	156	175

Pricing is continued on the following page.

MUNELF Tackable Fabric Fascia (Continued)

DIMENSIONS CM

PRICING

H	W	Fabric Gr.AA	Gr.A/COM	Gr.1
057/ 57	06 / 60	55	62	67
057/ 57	08 / 80	67	72	76
057/ 57	09 / 90	78	86	90
057/ 57	10 / 100	89	98	109
057/ 57	12 / 120	102	112	121
057/ 57	14 / 140	121	129	139
057/ 57	15 / 150	129	144	152
057/ 57	16 / 160	150	166	176
057/ 57	18 / 180	171	188	198

H	W	Fabric Gr.AA	Gr.A/COM	Gr.1
060/ 60	06 / 60	55	62	67
060/ 60	08 / 80	67	72	76
060/ 60	09 / 90	78	86	90
060/ 60	10 / 100	89	98	109
060/ 60	12 / 120	102	112	121
060/ 60	14 / 140	121	129	139
060/ 60	15 / 150	129	144	152
060/ 60	16 / 160	150	166	176
060/ 60	18 / 180	171	188	198

H	W	Fabric Gr.AA	Gr.A/COM	Gr.1
072/ 72	06 / 60	60	64	69
072/ 72	08 / 80	70	78	83
072/ 72	09 / 90	85	92	96
072/ 72	10 / 100	95	105	113
072/ 72	12 / 120	110	119	127
072/ 72	14 / 140	126	136	145
072/ 72	15 / 150	141	153	157
072/ 72	16 / 160	172	187	194
072/ 72	18 / 180	186	204	212

H	W	Fabric Gr.AA	Gr.A/COM	Gr.1
075/ 75	06 / 60	62	64	69
075/ 75	08 / 80	71	78	83
075/ 75	09 / 90	88	92	96
075/ 75	10 / 100	98	105	113
075/ 75	12 / 120	112	119	127
075/ 75	14 / 140	128	136	145
075/ 75	15 / 150	146	153	157

H	W	Fabric Gr.AA	Gr.A/COM	Gr.1
090/ 90	06 / 60	80	86	88
090/ 90	08 / 80	92	98	105
090/ 90	09 / 90	111	118	123
090/ 90	10 / 100	125	134	142
090/ 90	12 / 120	137	152	161
090/ 90	14 / 140	171	185	197
090/ 90	15 / 150	204	217	232

M U A E L F

Tackable Fabric Fascia for Freestanding District (Slot Mount)

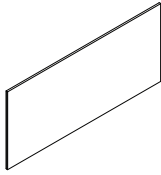

The Tackable Fabric Fascia provides a tackable panel wall finish.

WHAT'S INCLUDED

1 fascia with cut out as specified, fascia connectors.

NOTES

Not all height/width combinations are available, 87cm high fascia can be specified to a maximum of 150cm width only. See pricing for exact offering.

Fascia is to only be applied to District Panel that is supported by the Freestanding Foot (MUAFFN).

The 54cm and 57cm fascias must be ordered with a 15cm high fascia as Elevated panels are not applicable in a freestanding application.

69cm and 72cm height fascia can only be applied to the Flush Panel with Accessory Beam (MUAFFR), Elevated Panel with Accessory Beam or Convertible Panel with Accessory Beam (MUAFCR).

PRODUCT OPTIONS

Height	Width	Fascia Finish
015, 054, 057, 069, 072, 087	06, 08, 09, 10, 12, 14, 15, 16, 18	Grade AA Grade COM Grade A Grade 1

SAMPLE ORDER CODE

MUAELF 057	09	E324
------------	----	------

DIMENSIONS CM

PRICING

H	W	Fabric Gr.AA	Gr.A/COM	Gr.1
015/ 15	06 / 60	39	40	43
015/ 15	08 / 80	47	49	51
015/ 15	09 / 90	53	55	57
015/ 15	10 / 100	59	61	63
015/ 15	12 / 120	65	67	70
015/ 15	14 / 140	79	81	86
015/ 15	15 / 150	91	93	100
015/ 15	16 / 160	104	108	114
015/ 15	18 / 180	114	121	125

H	W	Fabric Gr.AA	Gr.A/COM	Gr.1
054/ 54	06 / 60	47	52	55
054/ 54	08 / 80	55	61	68
054/ 54	09 / 90	64	70	80
054/ 54	10 / 100	78	85	89
054/ 54	12 / 120	87	94	100
054/ 54	14 / 140	104	112	119
054/ 54	15 / 150	113	123	129
054/ 54	16 / 160	127	141	152
054/ 54	18 / 180	142	156	175

Pricing is continued on the following page.

Tackable Fabric Fascia for Freestanding District
(Slot Mount) (Continued)

DIMENSIONS
CM

PRICING

H	W	Fabric Gr.AA	Gr.A/COM	Gr.1
057/ 57	06 / 60	47	52	55
057/ 57	08 / 80	55	61	68
057/ 57	09 / 90	64	70	80
057/ 57	10 / 100	78	85	89
057/ 57	12 / 120	87	94	100
057/ 57	14 / 140	104	112	119
057/ 57	15 / 150	113	123	129
057/ 57	16 / 160	127	141	152
057/ 57	18 / 180	142	156	175

H	W			
069/ 69	06 / 60	70	77	82
069/ 69	08 / 80	80	88	98
069/ 69	09 / 90	96	105	120
069/ 69	10 / 100	110	120	126
069/ 69	12 / 120	121	131	139
069/ 69	14 / 140	149	160	168
069/ 69	15 / 150	174	190	201
069/ 69	16 / 160	192	213	230
069/ 69	18 / 180	210	231	256

H	W			
072/ 72	06 / 60	70	77	82
072/ 72	08 / 80	80	88	98
072/ 72	09 / 90	96	105	120
072/ 72	10 / 100	110	120	126
072/ 72	12 / 120	121	131	139
072/ 72	14 / 140	149	160	168
072/ 72	15 / 150	174	190	201
072/ 72	16 / 160	192	213	230
072/ 72	18 / 180	210	231	256

H	W			
072/ 72	06 / 60	80	86	88
072/ 72	08 / 80	92	98	105
072/ 72	09 / 90	111	118	123
072/ 72	10 / 100	125	134	142
072/ 72	12 / 120	137	152	161
072/ 72	14 / 140	171	185	197
072/ 72	15 / 150	204	217	232

fascias

M U N E M B

Whiteboard Fascia (Slot Mount)

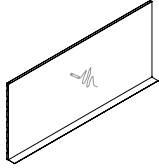

The Whiteboard Fascia provides an erasable message board surface.

WHAT'S INCLUDED
1 fascia.

WHAT'S EXCLUDED
Fascia Light Block (MUNEX) is required for additional segmentation and must be specified separately. Can be found on page 49

NOTES

The width of the tray equals the width of the fascia.

Please note that two trays cannot be used side-by-side in a 90° configuration.

PRODUCT OPTIONS

Tray	Height	Width	Tray Finish (If applicable)
N No Tray	045 ,060, 075, 090	09, 10, 12	Foundation
T With Tray			Mica

SAMPLE ORDER CODE

MUNEMB T	060	09	Q
----------	-----	----	---

**DIMENSIONS
CM**

PRICING

H	W	NO TRAY (N)	WITH TRAY (T)
045 / 45	09 / 90	283	327
045 / 45	10 / 100	307	355
045 / 45	12 / 120	331	381
060 / 60	09 / 90	312	356
060 / 60	10 / 100	355	402
060 / 60	12 / 120	401	451
075 / 75	09 / 90	337	381
075 / 75	10 / 100	380	430
075 / 75	12 / 120	423	478
090 / 90	09 / 90	366	410
090 / 90	10 / 100	403	439
090 / 90	12 / 120	439	493

The Accessory Fascia provides support for Personal Organizers (PAX) and fx Accessories to facilitate organization of the workspace.

WHAT'S INCLUDED

1 fascia and attachment hardware.

WHAT'S EXCLUDED

Fascia Light Block (MUNEX) is required for additional segmentation and must be specified separately. Can be found on page 49

NOTES

Personal Organizers (PAX) and fx Accessories can be found in Complements: Teknion's Ergonomics & Accessories Program.

MUNELA Accessory Fascia (Slot Mount)

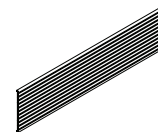

PRODUCT OPTIONS

Height	Width	Fascia Finish
015, 030, 045	06, 08, 09, 10, 12, 14, 15, 16, 18	Foundation Mica

SAMPLE ORDER CODE

MUNELA 030	06	Q
------------	----	---

DIMENSIONS

CM		PRICING
H	W	
015 / 15	06 / 60	93
015 / 15	08 / 80	101
015 / 15	09 / 90	114
015 / 15	10 / 100	123
015 / 15	12 / 120	130
015 / 15	14 / 140	141
015 / 15	15 / 150	150
015 / 15	16 / 160	160
015 / 15	18 / 180	172
030 / 30	06 / 60	108
030 / 30	08 / 80	120
030 / 30	09 / 90	137
030 / 30	10 / 100	149
030 / 30	12 / 120	164
030 / 30	14 / 140	185
030 / 30	15 / 150	207
030 / 30	16 / 160	228
030 / 30	18 / 180	249

DIMENSIONS

CM		PRICING
H	W	
045 / 45	06 / 60	121
045 / 45	08 / 80	139
045 / 45	09 / 90	160
045 / 45	10 / 100	174
045 / 45	12 / 120	197
045 / 45	14 / 140	232
045 / 45	15 / 150	264
045 / 45	16 / 160	296
045 / 45	18 / 180	328

fascias

MUNELMB

Metal Base Feed Fascia (Slot Mount)

The Metal Base Feed Fascia provides an opening for mounting of the base feed.

WHAT'S INCLUDED
1 fascia with cut out, as specified.

NOTES

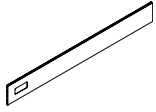

76

PRODUCT OPTIONS

Height	Width	Fascia Finish
015	06, 08, 09, 10, 12, 14, 15, 16, 18	Foundation Mica

SAMPLE ORDER CODE

MUNELMB 015	06	Q
-------------	----	---

DIMENSIONS

CM		PRICING
H	W	
015 / 15	06 / 60	39
015 / 15	08 / 80	43
015 / 15	09 / 90	49
015 / 15	10 / 100	54
015 / 15	12 / 120	58
015 / 15	14 / 140	69
015 / 15	15 / 150	81
015 / 15	16 / 160	91
015 / 15	18 / 180	101

The Metal Base Feed Fascia provides an opening for mounting of the base feed.

WHAT'S INCLUDED

1 fascia with cut out, as specified.

NOTES

Fascia is to only be applied to District Panel that is supported by the Freestanding Foot (MUAFFN).

M U A E L M B

**Metal Base Feed Fascia
for Freestanding District**



PRODUCT OPTIONS

Height	Width	Frame Finish
015	06, 08, 09, 10, 12, 14, 15, 16, 18	Foundation Mica

SAMPLE ORDER CODE

MUAELMB 015	06	Q
-------------	----	---

DIMENSIONS

CM		PRICING
H	W	
015 / 15	06 / 60	49
015 / 15	08 / 80	54
015 / 15	09 / 90	58
015 / 15	10 / 100	69
015 / 15	12 / 120	81
015 / 15	14 / 140	91
015 / 15	15 / 150	101
015 / 15	16 / 160	111
015 / 15	18 / 180	139

fascias

M U A E L F B

Fabric Base Feed Fascia for Freestanding District (Slot Mount)

The Fabric Base Feed Fascia provides an opening for mounting of the base feed.

WHAT'S INCLUDED

1 fascia with cut out, as specified.

NOTES

Fabric Base Feed Fascia is not tackable.

Fascia is to only be applied to District Panel that is supported by the Freestanding Foot (MUAFFN).



78

PRODUCT OPTIONS

Height	Width	Fascia Finish
015	09, 10, 12, 14, 15, 16, 18	Grade AA Grade COM Grade A Grade 1

SAMPLE ORDER CODE

MUAELFB 015	06	160
-------------	----	-----

DIMENSIONS

CM

PRICING

H	W	Fabric Gr.AA	Gr.A/COM	Gr.1
015/ 15	09 / 90	63	65	67
015/ 15	10 / 100	69	71	73
015/ 15	12 / 120	76	79	82
015/ 15	14 / 140	89	91	96
015/ 15	15 / 150	101	104	112
015/ 15	16 / 160	115	118	124
015/ 15	18 / 180	126	131	136

The Double Glass (L-Style) Window is an alternative to an upper fascia, providing an uninterrupted double glass surface from worksurface height to the top frame of a panel wall or from panel wall rail height to the top frame of a panel wall.

WHAT'S INCLUDED

Framed window insert and attachment hardware.

NOTES

Standard Glass, Clear is a clear tempered glass finish.

Standard Glass, Frost is a etched tempered glass.

MUNELWD Window (L-Style) – Double Glass (Slot Mount)

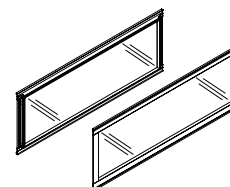

PRODUCT OPTIONS

Height	Width	Glass Finish	Frame Finish
030, 045, 060, 075, 090	06, 08, 09, 10, 12, 14, 15	5 Clear Standard Glass 6 Frost Standard Glass	Foundation Mica

SAMPLE ORDER CODE

MUNELWD 075	06	6	Q
-------------	----	---	---

DIMENSIONS CM

PRICING

H	W	Standard Clear	Glass Frost
030 / 30	06 / 60	317	331
030 / 30	08 / 80	356	374
030 / 30	09 / 90	395	417
030 / 30	10 / 100	443	468
030 / 30	12 / 120	485	515
030 / 30	14 / 140	521	553
030 / 30	15 / 150	568	603
045 / 45	06 / 60	359	374
045 / 45	08 / 80	402	423
045 / 45	09 / 90	447	470
045 / 45	10 / 100	501	529
045 / 45	12 / 120	549	582
045 / 45	14 / 140	588	624
045 / 45	15 / 150	642	681
060 / 60	06 / 60	357	379
060 / 60	08 / 80	400	427
060 / 60	09 / 90	443	476
060 / 60	10 / 100	511	549
060 / 60	12 / 120	555	598
060 / 60	14 / 140	603	650
060 / 60	15 / 150	646	700

DIMENSIONS INCHES / MM

PRICING

H	W	Standard Clear	Glass Frost
075 / 75	06 / 60	375	397
075 / 75	08 / 80	420	448
075 / 75	09 / 90	465	499
075 / 75	10 / 100	537	575
075 / 75	12 / 120	582	628
075 / 75	14 / 140	633	683
075 / 75	15 / 150	677	734
090 / 90	06 / 60	465	501
090 / 90	08 / 80	520	565
090 / 90	09 / 90	575	630
090 / 90	10 / 100	673	737
090 / 90	12 / 120	733	805
090 / 90	14 / 140	792	875
090 / 90	15 / 150	849	940

MUNELK Fascia Clip Kit

The Fascia Clip Kit is required to attach clip-mounted fascias to a Convertible Wall Frame.

WHAT'S INCLUDED
Package of 25 or 100 clips, as specified.

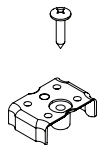

80

PRODUCT OPTIONS

Quantity

25 25 clips
100 100 clips

SAMPLE ORDER CODE

MUNELK 100

QUANTITY

PRICING

25
100

75
273

thin panel

thin panel

PRODUCT MAP/ TABLE OF CONTENT	83
THIN PANEL OVERVIEW	86
THIN PANEL PLANNING	88
THIN PANEL BASICS	89
PRODUCT LISTING	90

thin panel

product map

MUFF Fabric Bottom,
Fabric Top District Std
Thin Panel

Page 90
Height: 105cm,120cm,135cm & 150cm,
/ Width:60cm-180cm



MUFFW Fabric Bottom,
Fabric & Whiteboard
Top District Std Panel

Page 94
Height: 105cm,120cm,135cm & 150cm,
/ Width:60cm-180cm



MUWF Fabric Bottom,
Whiteboard
Top District Std Panel

Page 98
Height: 105cm,120cm,135cm & 150cm,
/ Width:60cm-180cm



MUFMF Fabric & metal Bottom,
Fabric Top District Std
Thin Panel

Page 102
Height: 105cm,120cm,135cm & 150cm,
/ Width:60cm-180cm



MUFMW Metal & Fabric Bottom,
Fabric & Whiteboard
Top District Std Thin Panel

Page 106
Height: 105cm,120cm,135cm & 150cm,
/ Width:60cm-180cm



MUWMF Fabric & Metal Bottom,
Whiteboard Top District Std
Thin Panel

Page 110
Height: 105cm,120cm,135cm & 150cm,
/ Width:60cm-180cm



MUFM Metal Bottom,
Fabric Top District Std
Thin Panel

Page 114
Height: 105cm,120cm,135cm & 150cm,
/ Width:60cm-180cm



MUWFM Metal Bottom,
Fabric & Whiteboard Top
District Std Thin Panel

Page 118
Height: 105cm,120cm,135cm & 150cm,
/ Width:60cm-180cm



MUWM Metal Bottom,
Fabric, Whiteboard Top
District Std Thin Panel

Page 122
Height: 105cm,120cm,135cm & 150cm,
/ Width:60cm-180cm



MUAG Glaze Add-on Screen

Page 126
Height: 15cm-30cm / Width:60cm-180cm

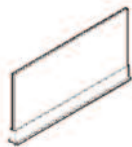

MUMAF Fabric District
Monolithic Panel

Page 127
Height: 105cm-120cm / Width:60cm-120cm



MUMFM Fabric & Metal District
Monolithic Panel

Page 128
Height: 105cm-120cm / Width:60cm-120cm



thin panel product map

MUMAM Metal District
Monolithic Panel

Page 129
Height: 105cm-120cm / Width:60cm-120cm



MUMFW Fabric & White District
Monolithic Panel

Page 130
Height: 105cm-120cm / Width:60cm-120cm



MUMAW Whiteboard District
Monolithic Panel

Page 131
Height: 105cm-120cm / Width:60cm-120cm



85

MUMAG Glaze District
Monolithic Panel

Page 132
Height: 105cm-120cm / Width:60cm-120cm



MUGF Fabric Bottom & Glaze Top
District Monolithic Panel

Page 134
Height: 105cm-120cm / Width:60cm-120cm



MUGMF Fabric & Metal Glaze,
Top District Monolithic
Panel

Page 138
Height: 105cm-120cm / Width:60cm-120cm



MUGM Metal Bottom, Glaze
Top District Thin Panel

Page 142
Height: 105cm-120cm / Width:60cm-120cm



thin panel overview

Thin Panel provides privacy, space division and worksurface support

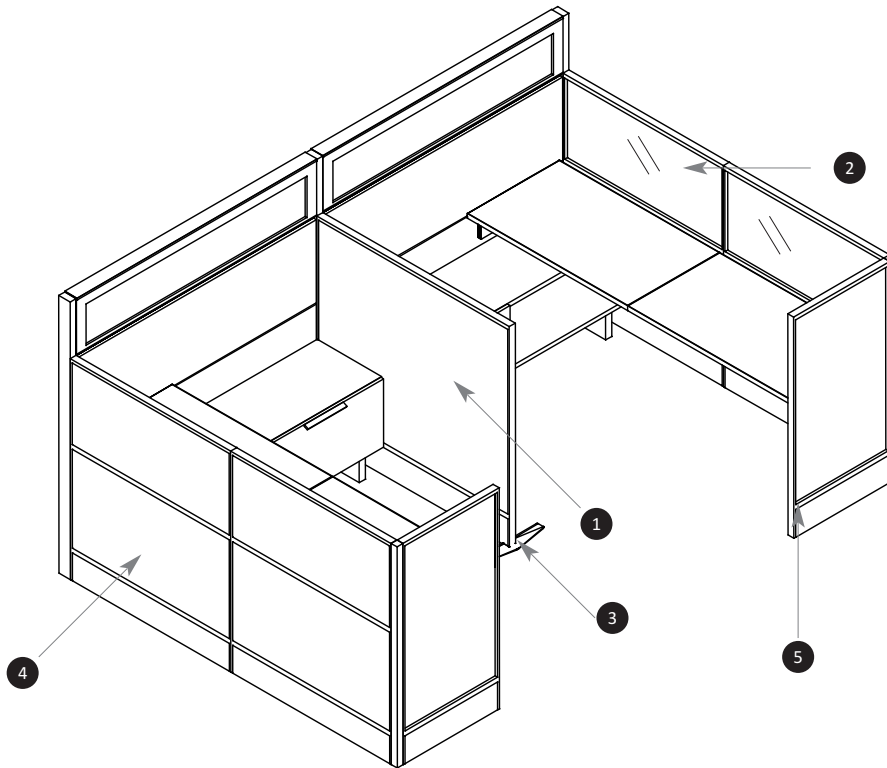

- 1 Monolithic Thin Panel provides privacy and adjacent panel support and NOT structural worksurface support, ON MODULE ONLY
- 2 Thin Panel - Glazed Segment is available on Standard (upper cell only) & Monolithic panels
- 3 Stabiliser Feet provides stability to Thin Panel beyond an adjacent worksurface or panel connection and can be used on all Thin Panels to provide stability for Thin Panels runs and freestanding Monolithic Thin Panel configurations
- 4 Standard Thin Panel provides privacy and worksurface support and attaches to District Panels On Module. It also connects to thin panels and screens ON module. Available ELEVATED OR with BASEBOARD (baseboard shown). Not load bearing
- 5 An End Trim is required at the end of each panel

thin panel overview (continued)

The following outlines the feature of the Thin Panel

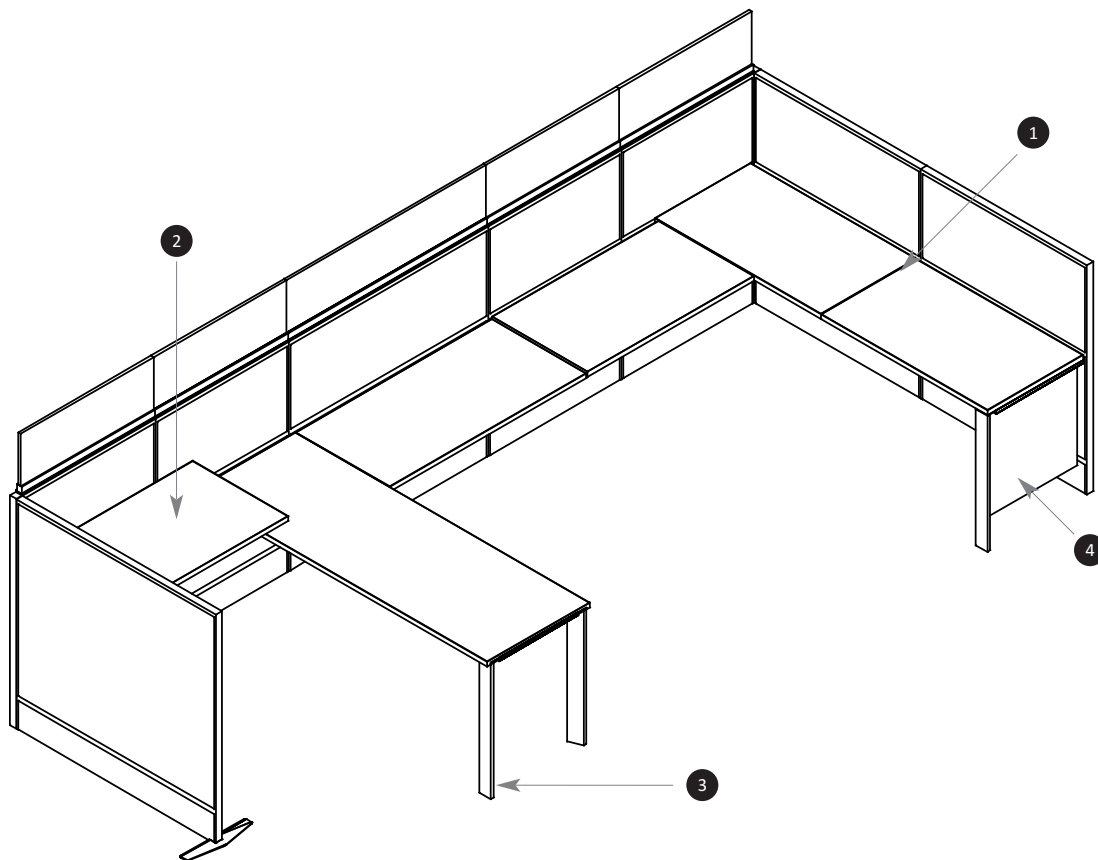

- 1 On Module Cantilevers offers support toward the front of the workspaces
- 2 Off Module Cantilevers offers height adjustability in an off module condition
- 3 Fixed Height Worksurface supports workspaces at the front workspaces rail on the standard panel
- 4 End Gable provides stability to Thin Panels through the worksurface support. This support is based on the District Leg

thin panel basics

Thin Panels are available in two styles, standard and monolithic

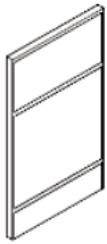

Standard Panel (MUFF, MUFFW, MUFFW, MUWF, MUFMF, MUFMW, MUFM, MUWFM, MUWM)

- Thin Panels are NOT handed
- Thin Panels comes a top trim
- Thin Panels require end trim at the of a run
- Intermediate trims and connecting hardware must be specified separately
- The mid rail accomodates worksurface connection and support
- The upper rail accepts signage
- The Thin Panel DOES NOT support mounted storage
- Thin Panel can be stabilized with a stabilizer foot
- Not Load Bearing
- Elements are detachable for connection purpose



Monolithic Panel (MUMAF, MUMFM, MUMAM, MUMFW, MUMAW, MUMAG)

- Thin Panels are NOT handed
- Thin Panels comes a top trim
- Thin Panels require end trim at the of a run
- Intermediate trims and connecting hardware must be specified separately
- The upper rail accepts signage
- The Thin Panel DOES NOT support mounted storage
- Thin Panel can be stabilized with a stabilizer foot
- Not Load Bearing
- Elements are detachable for connection purpose

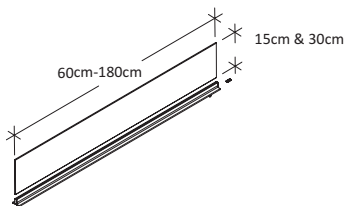

Glazed Add-on Screen (MUAG)

- Provides a light frameless alternative to a window or solid fascia at the top of a panel
- Available in glass
- Can be mounted on- or off-module, or span two panel walls but cannot span a 180° spacer or 90° connection
- Replaces the top trim of the same width on the panel wall

thin panel planning

The following should be considered when planning with Thin Panels

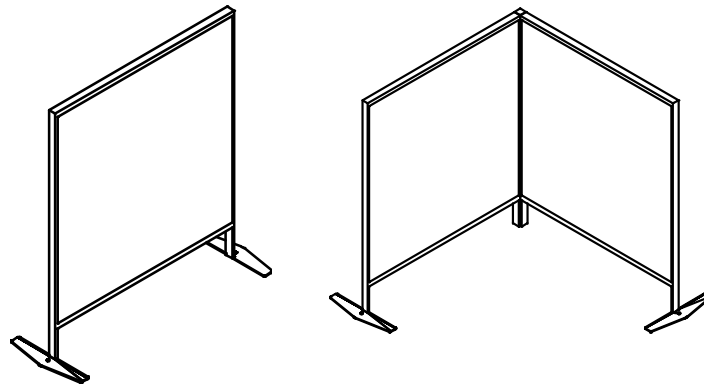

Thin Panels can stand alone with 2 stabilizer feet OR link to other Thin Panels at 90° using 1 stabilizer foot per panel.

When extending Thin panel runs at 180° connections, additional stabilization is required at the connection point: either a panel, semi-suspended worksurface OR storage

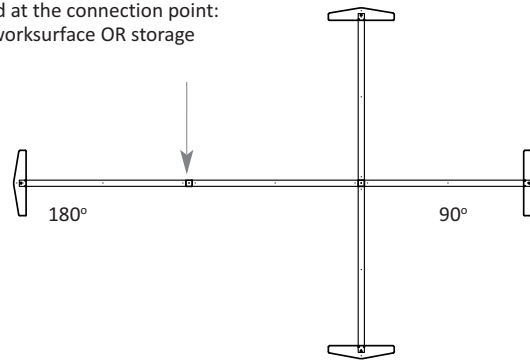

Note: Can ONLY be used AT END OF RUN

thin panel

MUFF

Fabric Bottom, Fabric Top District Std Thin Panel



The fabric bottom & Fabric top allows a variety of fabric options on both the top and bottom sections

WHAT'S INCLUDED

1 Screen

WHAT'S EXCLUDED

List price for panel fabric with difference fabric grade combinations will default on the higher grade of fabric chosen

PRODUCT OPTIONS

Top Style	Base Style	Height	Width	Type	Fabric A	Fabric B	Finish
(1) Standard Panel	(E) Elevated (B) Baseboard	105, 120, 135, 150	06, 08, 09, 10, 12, 14, 15, 16, 18	(1) Fabric A on the front, Fabric B on the back (2) Fabric A on the top, Fabric B on the bottom	Grade AA, Grade COM Grade A Fabric Grade 1	Grade AA, Grade COM Grade A Fabric Grade 1	Foundation Mica

SAMPLE ORDER CODE

MUFF 1	E	120	14	2	J351	X160	Q
--------	---	-----	----	---	------	------	---

DIMENSIONS CM

PRICING *

FABRIC BOTTOM, FABRIC TOP DISTRICT THIN PANEL, STANDARD PANEL, BASEBOARD

H	W	Fabric Grade AA	Fabric Grade A	Fabric COM	Fabric Grade 1
104/104	060/60	351	375	375	392
104/104	080/80	411	443	443	465
104/104	090/90	469	508	508	532
104/104	100/100	512	553	553	580
104/104	120/120	524	569	569	597
104/104	140/140	590	642	642	676
104/104	150/150	654	715	715	751
104/104	160/160	718	788	788	826
104/104	180/180	783	863	863	901
119/119	060/60	424	456	456	477
119/119	080/80	496	539	539	563
119/119	090/90	565	616	616	645
119/119	100/100	616	670	670	701
119/119	120/120	630	689	689	722
119/119	140/140	709	777	777	816
119/119	150/150	785	864	864	906
119/119	160/160	864	951	951	906
119/119	180/180	943	1030	1030	1086

If Mica is specified, add 16

Pricing is continued on the following page.

*The above prices apply to panels finished in one fabric grade. If more than one fabric grade is specified on the screen, please refer to your specifying software for exact price

M U F F

Fabric Bottom, Fabric Top, District Std Thin Panel (continued)

DIMENSIONS
CM

PRICING*

FABRIC BOTTOM, FABRIC TOP DISTRICT THIN PANEL, STANDARD PANEL, BASEBOARD

H	W	Fabric Grade AA	Fabric Grade A	Fabric COM	Fabric Grade 1
134/134	060/60	457	470	456	508
134/134	080/80	534	581	443	627
134/134	090/90	608	663	508	716
134/134	100/100	662	722	553	780
134/134	120/120	677	740	569	799
134/134	140/140	762	836	642	903
134/134	150/150	843	927	715	1001
134/134	160/160	924	1018	788	1009
134/134	180/180	1005	1109	863	1198
149/149	060/60	494	508	508	521
149/149	080/80	577	627	627	657
149/149	090/90	657	716	716	748
149/149	100/100	715	780	780	814
149/149	120/120	630	799	799	838
149/149	140/140	709	903	903	946
149/149	150/150	785	1001	1001	1052
149/149	160/160	864	1099	1099	1158
149/149	180/180	943	1198	1198	1256
104/104	060/60	351	375	375	392
104/104	080/80	411	443	443	465
104/104	090/90	469	508	508	532
104/104	100/100	512	553	553	580
104/104	120/120	524	569	569	597
104/104	140/140	590	642	642	676
104/104	150/150	654	715	715	751
104/104	160/160	718	788	788	826
104/104	180/180	783	863	863	901
119/119	060/60	424	456	456	477
119/119	080/80	496	539	539	563
119/119	090/90	565	616	616	645
119/119	100/100	616	670	670	701
119/119	120/120	630	689	689	722
119/119	140/140	709	777	777	816
119/119	150/150	785	864	864	906
119/119	160/160	864	951	951	996
119/119	180/180	943	1030	1030	1086

Pricing is continued on the following page.

If Mica is specified, add 16

*The above prices apply to panels finished in one fabric grade. If more than one fabric grade is specified on the screen, please refer to your specifying software for exact price

thin panel

M U F F

Fabric Bottom, Fabric Top District Std Thin Panel (continued)

DIMENSIONS CM

PRICING*

FABRIC BOTTOM, FABRIC TOP DISTRICT THIN PANEL, STANDARD PANEL, ELEVATED

H	W	Fabric Grade AA	Fabric Grade A	Fabric COM	Fabric Grade 1
134/134	060/60	457	470	470	482
134/134	080/80	534	581	581	608
134/134	090/90	608	663	663	693
134/134	100/100	662	722	722	754
134/134	120/120	677	740	740	776
134/134	140/140	762	836	836	876
134/134	150/150	843	927	927	974
134/134	160/160	924	1018	1018	1072
134/134	180/180	1005	1109	1109	1163
149/149	060/60	494	508	508	521
149/149	080/80	577	627	627	657
149/149	090/90	657	716	716	748
149/149	100/100	715	780	780	814
149/149	120/120	731	799	799	838
149/149	140/140	823	903	903	946
149/149	150/150	910	1001	1001	1052
149/149	160/160	998	1099	1099	1158
149/149	180/180	1085	1198	1198	1256

If Mica is specified, add 16

*The above prices apply to panels finished in one fabric grade. If more than one fabric grade is specified on the screen, please refer to your specifying software for exact price

thin panel

M U F F W

Fabric Bottom, Fabric & Whiteboard Top District Std Thin Panel

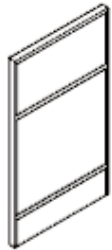

Fabric bottom, Fabric & Whiteboard top allows a variety of Fabric option on bottom section

WHAT'S INCLUDED
1 screen

NOTES

List price for panel fabric with difference fabric grade combinations will default on the higher grade of fabric chosen

94

PRODUCT OPTIONS

Top Style	Base Style	Height	Width	Type	Fabric A	Fabric B	Finish
(1) Standard Panel	(E) Elevated (B) Baseboard	105, 120, 135, 150	06, 08, 09, 10, 12, 14, 15, 16, 18	(1) Fabric A on the front, Fabric B on the back (2) Fabric A on the top, Fabric B on the bottom	Grade AA, GradeCOM Grade A Grade 1	Grade AA Grade COM Grade A Grade 1	Foundation Mica

SAMPLE ORDER CODE

MUFFW 1	E	120	10	1	J351	X160	Q
---------	---	-----	----	---	------	------	---

DIMENSIONS CM

PRICING*

FABRIC BOTTOM, FABRIC & WHITEBOARD TOP DISTRICT THIN PANEL, STANDARD PANEL, BASEBOARD

H	W	Fabric Grade AA	Fabric Grade A	Fabric COM	Fabric Grade 1
104/104	060/60	462	495	495	517
104/104	080/80	541	586	586	614
104/104	090/90	618	670	670	703
104/104	100/100	674	731	731	766
104/104	120/120	689	752	752	788
104/104	140/140	777	849	849	894
104/104	150/150	860	943	943	992
104/104	160/160	943	1037	1037	1090
104/104	180/180	1026	1131	1131	1188
119/119	060/60	468	502	502	525
119/119	080/80	546	593	593	621
119/119	090/90	622	677	677	709
119/119	100/100	679	737	737	772
119/119	120/120	695	758	758	794
119/119	140/140	783	855	855	898
119/119	150/150	865	951	951	997
119/119	160/160	947	1047	1047	1096
119/119	180/180	1029	1143	1143	1195

Pricing is continued on the following page.

If Mica is specified, add 16

*The above prices apply to panels finished in one fabric grade. If more than one fabric grade is specified on the screen, please refer to your specifying software for exact price

M U F F W

Fabric Bottom, Fabric & Whiteboard Top
District Std Thin Panel (continued)DIMENSIONS
CM

PRICING*

FABRIC BOTTOM, FABRIC & WHITEBOARD TOP DISTRICT THIN PANEL, STANDARD PANEL, BASEBOARD

H	W	Fabric Grade AA	Fabric Grade A	Fabric COM	Fabric Grade 1
134/134	060/60	504	515	515	530
134/134	080/80	588	638	638	668
134/134	090/90	670	730	730	762
134/134	100/100	730	794	794	829
134/134	120/120	747	813	813	854
134/134	140/140	840	919	919	964
134/134	150/150	929	1019	1019	1071
134/134	160/160	1018	1119	1119	1178
134/134	180/180	1107	1219	1219	1285
149/149	060/60	544	556	556	572
149/149	080/80	635	689	689	721
149/149	090/90	724	788	788	823
149/149	100/100	788	858	858	895
149/149	120/120	807	878	878	922
149/149	140/140	907	993	993	1041
149/149	150/150	1003	1101	1101	1157
149/149	160/160	1099	1209	1209	1272
149/149	180/180	1196	1317	1317	1388
104/104	060/60	462	495	495	517
104/104	080/80	541	586	586	614
104/104	090/90	618	670	670	703
104/104	100/100	674	731	731	766
104/104	120/120	689	752	752	788
104/104	140/140	777	849	849	894
104/104	150/150	860	943	943	992
104/104	160/160	943	1037	1037	1090
104/104	180/180	1026	1131	1131	1188
119/119	060/60	468	502	502	525
119/119	080/80	546	593	593	621
119/119	090/90	622	677	677	709
119/119	100/100	679	737	737	772
119/119	120/120	695	758	758	794
119/119	140/140	783	855	855	898
119/119	150/150	865	951	951	997
119/119	160/160	947	1047	1047	1096
119/119	180/180	1029	1143	1143	1195

Pricing is continued on the following page.

If Mica is specified, add 16

*The above prices apply to panels finished in one fabric grade. If more than one fabric grade is specified on the screen, please refer to your specifying software for exact price

thin panel

M U F F W

Fabric Bottom, Fabric & Whiteboard
Top District Std Thin Panel
(Continued)

DIMENSIONS CM

PRICING*

FABRIC BOTTOM, FABRIC & WHITEBOARD TOP DISTRICT THIN PANEL, STANDARD PANEL, ELEVATED

H	W	Fabric Grade AA	Fabric Grade A	Fabric COM	Fabric Grade 1
134/134	060/60	504	515	515	530
134/134	080/80	588	638	638	668
134/134	090/90	670	730	730	762
134/134	100/100	730	794	794	829
134/134	120/120	747	813	813	854
134/134	140/140	840	919	919	964
134/134	150/150	929	1019	1019	1071
134/134	160/160	1018	1119	1119	1178
134/134	180/180	1107	1219	1219	1285
149/149	060/60	544	556	556	572
149/149	080/80	635	689	689	721
149/149	090/90	724	788	788	823
149/149	100/100	788	858	858	895
149/149	120/120	807	878	878	922
149/149	140/140	907	993	993	1041
149/149	150/150	1003	1101	1101	1157
149/149	160/160	1099	1209	1209	1272
149/149	180/180	1196	1317	1317	1388

If Mica is specified, add 16

*The above prices apply to panels finished in one fabric grade. If more than one fabric grade is specified on the screen, please refer to your specifying software for exact price

thin panel

M U W F

Fabric Bottom, Whiteboard Top District Std Thin Panel



Fabric of the bottom width whiteboard top allows a variety of options on bottom sections

WHAT'S INCLUDED

1 Screen

NOTES

List price for panel fabric with difference fabric grade combinations will default on the higher grade of fabric chosen

98

PRODUCT OPTIONS

Top Style	Base Style	Height	Width	Bottom Segment Front	Bottom Segment Front	Fabric B	Finish
(1) Standard Panel	(E) Elevated (B) Baseboard	105, 120, 135, 150	06, 08, 09, 10, 12, 14, 15, 16, 18	Grade AA Grade COM Grade A Grade 1	Grade AA, Grade COM Grade A Grade 1	Grade AA, Grade COM Grade A Grade 1	Foundation Mica

SAMPLE ORDER CODE

MUWF 1	E	120	16	X160	X160	X160	Q
--------	---	-----	----	------	------	------	---

DIMENSIONS CM

PRICING*

FABRIC BOTTOM, FABRIC & WHITEBOARD TOP DISTRICT THIN PANEL, STANDARD PANEL, BASEBOARD

H	W	Bottom Seg. Front, Fabric Grade AA	Bottom Seg. Front, Fabric Grade A	Bottom Seg. Front, Fabric COM	Bottom Seg. Front, Fabric Grade 1
104/104	060/60	462	495	495	517
104/104	080/80	541	586	586	614
104/104	090/90	618	670	670	703
104/104	100/100	674	731	731	766
104/104	120/120	689	752	752	788
104/104	140/140	777	849	849	894
104/104	150/150	860	943	943	992
104/104	160/160	943	1037	1037	1090
104/104	180/180	1026	1131	1131	1188
119/119	060/60	468	502	502	525
119/119	080/80	546	593	593	621
119/119	090/90	622	677	677	709
119/119	100/100	679	737	737	772
119/119	120/120	695	758	758	794
119/119	140/140	783	855	855	898
119/119	150/150	865	951	951	997
119/119	160/160	947	1047	1047	1096
119/119	180/180	1029	1143	1143	1195

Pricing is continued on the following page.

If Mica is specified, add 16

*The above prices apply to panels finished in one fabric grade. If more than one fabric grade is specified on the screen, please refer to your specifying software for exact price

M U W F

Fabric Bottom, Whiteboard Top District Std Thin Panel (Continued)

DIMENSIONS
CM

PRICING*

FABRIC BOTTOM, FABRIC & WHITEBOARD TOP DISTRICT THIN PANEL, STANDARD PANEL BASEBOARD

H	W	Bottom Seg. Front, Fabric Grade AA	Bottom Seg. Front, Fabric Grade A	Bottom Seg. Front, Fabric COM	Bottom Seg. Front, Fabric Grade 1
134/134	060/60	504	515	515	530
134/134	080/80	588	638	638	668
134/134	090/90	670	730	730	762
134/134	100/100	730	794	794	829
134/134	120/120	747	813	813	854
134/134	140/140	840	919	919	964
134/134	150/150	929	1019	1019	1071
134/134	160/160	1018	1119	1119	1178
134/134	180/180	1107	1219	1219	1285
149/149	060/60	544	556	556	572
149/149	080/80	635	689	689	721
149/149	090/90	724	788	788	823
149/149	100/100	788	858	858	895
149/149	120/120	807	878	878	922
149/149	140/140	907	993	993	1041
149/149	150/150	1003	1101	1101	1157
149/149	160/160	1099	1209	1209	1272
149/149	180/180	1196	1317	1317	1388
104/104	060/60	462	495	495	517
104/104	080/80	541	586	586	614
104/104	090/90	618	670	670	703
104/104	100/100	674	731	731	766
104/104	120/120	689	752	752	788
104/104	140/140	777	849	849	894
104/104	150/150	860	943	943	992
104/104	160/160	943	1037	1037	1090
104/104	180/180	1026	1131	1131	1188
119/119	060/60	468	502	502	525
119/119	080/80	546	593	593	621
119/119	090/90	622	677	677	709
119/119	100/100	679	737	737	772
119/119	120/120	695	758	758	794
119/119	140/140	783	855	855	898
119/119	150/150	865	951	951	997
119/119	160/160	947	1047	1047	1096
119/119	180/180	1029	1143	1143	1195

Pricing is continued on the following page.

If Mica is specified, add 16

*The above prices apply to panels finished in one fabric grade. If more than one fabric grade is specified on the screen, please refer to your specifying software for exact price

thin panel

M U W F

Fabric Bottom, Whiteboard Top
District Std Thin Panel (continued)

DIMENSIONS
CM

PRICING*

FABRIC BOTTOM, FABRIC & WHITEBOARD TOP DISTRICT THIN PANEL, STANDARD PANEL BASEBOARD

H	W	Bottom Seg. Front, Fabric Grade AA	Bottom Seg. Front, Fabric Grade A	Bottom Seg. Front, Fabric COM	Bottom Seg. Front, Fabric Grade 1
134/134	060/60	504	515	515	530
134/134	080/80	588	638	638	668
134/134	090/90	670	730	730	762
134/134	100/100	730	794	794	829
134/134	120/120	747	813	813	854
134/134	140/140	840	919	919	964
134/134	150/150	929	1019	1019	1071
134/134	160/160	1018	1119	1119	1178
134/134	180/180	1107	1219	1219	1285
149/149	060/60	544	556	556	572
149/149	080/80	635	689	689	721
149/149	090/90	724	788	788	823
149/149	100/100	788	858	858	895
149/149	120/120	807	878	878	922
149/149	140/140	907	993	993	1041
149/149	150/150	1003	1101	1101	1157
149/149	160/160	1099	1209	1209	1272
149/149	180/180	1196	1317	1317	1388

If Mica is specified, add 16

*The above prices apply to panels finished in one fabric grade. If more than one fabric grade is specified on the screen, please refer to your specifying software for exact price

thin panel

M U F M F

Fabric & Metal Bottom, Fabric Top District Std Thin Panel

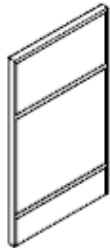

Fabric & Metal bottom with fabric top allows a variety of options on top and bottom sections

WHAT'S INCLUDED

1 Screen

NOTES

List price for panel fabric with difference fabric grade combinations will default on the higher grade of fabric chosen

102

PRODUCT OPTIONS

Top Style	Base Style	Height	Width	Type	Fabric A	Fabric B	Bottom Segment Front	Finish
(1) Standard Panel	(E) Elevated (B) Baseboard	105, 120, 135, 150	06, 08, 09, 10, 12, 14, 15, 16, 18	(1) Fabric A on the front, Fabric B on the back (2) Fabric A on the top, Fabric B on the bottom	Grade AA, Grade COM Grade A Fabric Grade 1	Grade AA Grade COM Grade A Grade 1	Foundation Mica	Foundation Mica

SAMPLE ORDER CODE

MUFMF 1	E	120	15	1	J351	X160	Q	Q
---------	---	-----	----	---	------	------	---	---

DIMENSIONS CM

PRICING*

FABRIC & METAL BOTTOM, FABRIC TOP DISTRICT THIN PANEL, STANDARD PANEL, BASEBOARD

H	W	Panel Fabric A, Fabric Grade AA	Panel Fabric A, Fabric Grade A	Panel Fabric A, Fabric COM	Panel Fabric A, Fabric Grade 1
104/104	060/60	347	372	372	389
104/104	080/80	407	436	436	459
104/104	090/90	465	497	497	522
104/104	100/100	508	541	541	567
104/104	120/120	520	555	555	581
104/104	140/140	586	625	625	655
104/104	150/150	649	693	693	723
104/104	160/160	712	761	761	655
104/104	180/180	775	830	830	723
119/119	060/60	419	452	452	472
119/119	080/80	491	528	528	556
119/119	090/90	560	602	602	632
119/119	100/100	611	650	650	680
119/119	120/120	625	671	671	702
119/119	140/140	704	758	758	788
119/119	150/150	780	840	840	873
119/119	160/160	856	922	922	960
119/119	180/180	932	1004	1004	1045

Pricing is continued on the following page.

If Mica is specified, add 16

*The above prices apply to panels finished in one fabric grade. If more than one fabric grade is specified on the screen, please refer to your specifying software for exact price

M U F M F
Fabric & Metal Bottom, Fabric Top
District Std Thin Panel
(Continued)

DIMENSIONS
CM

PRICING*

FABRIC & METAL BOTTOM, FABRIC TOP DISTRICT THIN PANEL, STANDARD PANEL, BASEBOARD

H	W	Panel Fabric A, Fabric Grade AA	Panel Fabric A, Fabric Grade A	Panel Fabric A, Fabric COM	Panel Fabric A, Fabric Grade 1
134/134	060/60	450	461	461	474
134/134	080/80	527	572	572	597
134/134	090/90	601	650	650	677
134/134	100/100	655	706	706	735
134/134	120/120	670	723	723	754
134/134	140/140	755	812	812	844
134/134	150/150	835	899	899	935
134/134	160/160	915	986	986	1026
134/134	180/180	995	1073	1073	1117
149/149	060/60	486	498	498	512
149/149	080/80	569	618	618	645
149/149	090/90	649	702	702	731
149/149	100/100	707	762	762	794
149/149	120/120	724	781	781	814
149/149	140/140	815	877	877	912
149/149	150/150	902	971	971	1010
149/149	160/160	988	1065	1065	1108
149/149	180/180	1075	1159	1159	1206
104/104	060/60	347	372	372	389
104/104	080/80	407	436	436	459
104/104	090/90	465	497	497	522
104/104	100/100	508	541	541	567
104/104	120/120	520	555	555	581
104/104	140/140	586	625	625	655
104/104	150/150	649	693	693	723
104/104	160/160	712	761	761	788
104/104	180/180	775	830	830	855
119/119	060/60	419	452	452	472
119/119	080/80	491	528	528	556
119/119	090/90	560	602	602	632
119/119	100/100	611	650	650	680
119/119	120/120	625	671	671	702
119/119	140/140	704	758	758	788
119/119	150/150	780	840	840	873
119/119	160/160	856	922	922	960
119/119	180/180	932	1004	1004	1045

Pricing is continued on the following page.

If Mica is specified, add 16

*The above prices apply to panels finished in one fabric grade. If more than one fabric grade is specified on the screen, please refer to your specifying software for exact price

thin panel

M U F M F

Fabric & Metal Bottom, Fabric Top

District Std Thin Panel

(Continued)

DIMENSIONS
CM

PRICING*

FABRIC & METAL BOTTOM, FABRIC TOP DISTRICT THIN PANEL, STANDARD PANEL, ELEVATED

H	W	Panel Fabric A, Fabric Grade AA	Panel Fabric A, Fabric Grade A	Panel Fabric A, Fabric COM	Panel Fabric A, Fabric Grade 1
134/134	060/60	450	461	461	474
134/134	080/80	527	572	572	597
134/134	090/90	601	650	650	677
134/134	100/100	655	706	706	735
134/134	120/120	670	723	723	754
134/134	140/140	755	812	812	844
134/134	150/150	835	899	899	935
134/134	160/160	915	986	986	1026
134/134	180/180	995	1073	1073	1117
149/149	060/60	486	498	498	512
149/149	080/80	569	618	618	645
149/149	090/90	649	702	702	731
149/149	100/100	707	762	762	794
149/149	120/120	724	781	781	814
149/149	140/140	815	877	877	912
149/149	150/150	902	971	971	1010
149/149	160/160	988	1065	1065	1108
149/149	180/180	1075	1159	1159	1206

If Mica is specified, add 16

*The above prices apply to panels finished in one fabric grade. If more than one fabric grade is specified on the screen, please refer to your specifying software for exact price

thin panel

M U F M W

Metal & Fabric Bottom, Fabric & Whiteboard Top District Std Thin Panel

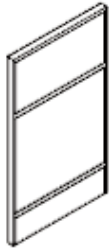

Metal & fabric bottom with fabric & whiteboard top allows variety of fabric and metal finishes at bottom and top sections

WHAT'S INCLUDED
1 screen

NOTES

List price for panel fabric with difference fabric grade combinations will default on the higher grade of fabric chosen

106

PRODUCT OPTIONS

Top Style	Base Style	Height	Width	Top Segment Front	Bottom Segment Front	Bottom Segment Back	Finish
(1) Standard Panel	(E) Elevated (B) Baseboard	105, 120, 135, 150	06, 08, 09, 10, 12, 14, 15, 16, 18	Grade AA, GradeCOM Grade A Grade 1	Grade AA, GradeCOM Grade A Grade 1	Foundation Mica	Foundation Mica

SAMPLE ORDER CODE

MUFMW 1	E	120	16	J351	J351	7	Q
---------	---	-----	----	------	------	---	---

DIMENSIONS CM

PRICING*

METAL & FABRIC BOTTOM, FABRIC & WHITEBOARD TOP DISTRICT THIN PANEL, STANDARD PANEL, BASEBOARD

H	W	Top Seg. Front, Fabric Grade AA	Top Seg. Front, Fabric Grade A	Top Seg. Front, Fabric COM	Top Seg. Front, Fabric Grade 1
104/104	060/60	429	461	461	483
104/104	080/80	502	541	541	569
104/104	090/90	573	616	616	645
104/104	100/100	624	664	664	696
104/104	120/120	640	686	686	719
104/104	140/140	721	775	775	805
104/104	150/150	798	859	859	893
104/104	160/160	875	944	944	980
104/104	180/180	952	1029	1029	1068
119/119	060/60	461	496	496	519
119/119	080/80	540	582	582	612
119/119	090/90	616	662	662	694
119/119	100/100	671	714	714	748
119/119	120/120	688	738	738	773
119/119	140/140	775	833	833	866
119/119	150/150	858	924	924	960
119/119	160/160	941	1015	1015	1054
119/119	180/180	1024	1106	1106	1148

Pricing is continued on the following page.

If Mica is specified, add 32

*The above prices apply to panels finished in one fabric grade. If more than one fabric grade is specified on the screen, please refer to your specifying software for exact price

M U F M W

Metal & Fabric Bottom, Fabric &
Whiteboard Top Std District Thin Panel
(Continued)

DIMENSIONS
CM

PRICING*

METAL & FABRIC BOTTOM, FABRIC & WHITEBOARD TOP DISTRICT THIN PANEL, STANDARD PANEL, BASEBOARD

H	W	Top Seg. Front, Fabric Grade AA	Top Seg. Front, Fabric Grade A	Top Seg. Front, Fabric COM	Top Seg. Front, Fabric Grade 1
134/134	060/60	498	536	536	561
134/134	080/80	583	629	629	661
134/134	090/90	665	715	715	750
134/134	100/100	725	771	771	808
134/134	120/120	743	797	797	835
134/134	140/140	837	900	900	935
134/134	150/150	927	998	998	1037
134/134	160/160	1016	1096	1096	1138
134/134	180/180	1106	1194	1194	1240
149/149	060/60	538	579	579	605
149/149	080/80	630	679	679	714
149/149	090/90	719	772	772	809
149/149	100/100	783	833	833	872
149/149	120/120	802	861	861	902
149/149	140/140	904	972	972	1010
149/149	150/150	1001	1078	1078	1120
149/149	160/160	1098	1184	1184	1229
149/149	180/180	1119	1290	1290	1339
104/104	060/60	429	461	461	483
104/104	080/80	502	541	541	569
104/104	090/90	573	616	616	645
104/104	100/100	624	664	664	696
104/104	120/120	640	686	686	719
104/104	140/140	721	775	775	805
104/104	150/150	798	859	859	893
104/104	160/160	875	944	944	980
104/104	180/180	952	1029	1029	1068
119/119	060/60	461	496	496	519
119/119	080/80	540	582	582	612
119/119	090/90	616	662	662	694
119/119	100/100	671	714	714	748
119/119	120/120	688	738	738	773
119/119	140/140	775	833	833	866
119/119	150/150	858	924	924	960
119/119	160/160	941	1015	1015	1054
119/119	180/180	1024	1106	1106	1148

Pricing is continued on the following page.

If Mica is specified, add 32

*The above prices apply to panels finished in one fabric grade. If more than one fabric grade is specified on the screen, please refer to your specifying software for exact price

thin panel

M U F M W

Metal & Fabric Bottom, Fabric & Whiteboard Top District Std Thin Panel (Continued)

DIMENSIONS CM

PRICING*

METAL & FABRIC BOTTOM, FABRIC & WHITEBOARD TOP DISTRICT THIN PANEL, STANDARD PANEL,ELEVATED

H	W	Top Seg. Front, Fabric Grade AA	Top Seg. Front, Fabric Grade A	Top Seg. Front, Fabric COM	Top Seg. Front, Fabric Grade 1
134/134	060/60	498	536	536	561
134/134	080/80	583	629	629	661
134/134	090/90	665	715	715	750
134/134	100/100	725	771	771	808
134/134	120/120	743	797	797	835
134/134	140/140	837	900	900	935
134/134	150/150	927	998	998	1037
134/134	160/160	1016	1096	1096	1138
134/134	180/180	1106	1194	1194	1240
149/149	060/60	538	579	579	605
149/149	080/80	630	679	679	714
149/149	090/90	719	772	772	809
149/149	100/100	783	833	833	872
149/149	120/120	802	861	861	902
149/149	140/140	904	972	972	1010
149/149	150/150	1001	1078	1078	1120
149/149	160/160	1098	1184	1184	1229
149/149	180/180	1119	1290	1290	1339

If Mica is specified, add 32

*The above prices apply to panels finished in one fabric grade. If more than one fabric grade is specified on the screen, please refer to your specifying software for exact price

thin panel

M U W M F

Fabric & Metal Bottom, Whiteboard
Top District Std Thin Panel

Metal & fabric bottom with whiteboard top allow fabric of metal options at bottom sections

WHAT'S INCLUDED

1 screen

NOTES

List price for panel fabric with difference fabric grade combinations will default on the higher grade of fabric chosen



110

PRODUCT OPTIONS

Top Style	Base Style	Height	Width	Top Segment Back	Bottom Segment Front	Bottom Segment Back	Finish
(1) Standard Panel	(E) Elevated (B) Baseboard	105, 120, 135, 150	06, 08, 09, 10, 12, 14, 15, 16, 18	Grade AA, Grade COM Grade A Grade 1	Foundation Mica	Grade AA, Grade COM Grade A Grade 1	Foundation z Mica

SAMPLE ORDER CODE

MUFMW 1	E	120	15	E329	7	X160	Q
---------	---	-----	----	------	---	------	---

**DIMENSIONS
CM**

PRICING*

FABRIC & METAL BOTTOM, WHITEBOARD TOP DISTRICT THIN PANEL, STANDARD PANEL, BASEBOARD

H	W	Top Seg. Front, Fabric Grade AA	Top Seg. Front, Fabric Grade A	Top Seg. Front, Fabric COM	Top Seg. Front, Fabric Grade 1
104/104	060/60	429	461	461	483
104/104	080/80	502	541	541	569
104/104	090/90	573	616	616	645
104/104	100/100	624	664	664	696
104/104	120/120	640	686	686	719
104/104	140/140	721	775	775	805
104/104	150/150	798	859	859	893
104/104	160/160	875	944	944	980
104/104	180/180	952	1029	1029	1068
119/119	060/60	461	496	496	519
119/119	080/80	540	582	582	612
119/119	090/90	616	662	662	694
119/119	100/100	671	714	714	748
119/119	120/120	688	738	738	773
119/119	140/140	775	833	833	866
119/119	150/150	858	924	924	960
119/119	160/160	941	1015	1015	1054
119/119	180/180	1024	1106	1106	1148

Pricing is continued on the following page.

If Mica is specified, add 16

*The above prices apply to panels finished in one fabric grade. If more than one fabric grade is specified on the screen, please refer to your specifying software for exact price

M U W M F

Fabric & Metal Bottom, Whiteboard
Top District Std Thin Panel
(Continued)

DIMENSIONS
CM

PRICING*

FABRIC & METAL BOTTOM, WHITEBOARD TOP DISTRICT THIN PANEL, STANDARD PANEL, BASEBOARD

H	W	Top Seg. Front, Fabric Grade AA	Top Seg. Front, Fabric Grade A	Top Seg. Front, Fabric COM	Top Seg. Front, Fabric Grade 1
134/134	060/60	498	536	536	561
134/134	080/80	583	629	629	661
134/134	090/90	665	715	715	750
134/134	100/100	725	771	771	808
134/134	120/120	743	797	797	835
134/134	140/140	837	900	900	935
134/134	150/150	927	998	998	1037
134/134	160/160	1016	1096	1096	1138
134/134	180/180	1106	1194	1194	1240
149/149	060/60	538	579	579	605
149/149	080/80	630	679	679	714
149/149	090/90	719	772	772	809
149/149	100/100	783	833	833	872
149/149	120/120	802	861	861	902
149/149	140/140	904	972	972	1010
149/149	150/150	1001	1078	1078	1120
149/149	160/160	1098	1184	1184	1229
149/149	180/180	1119	1290	1290	1339
104/104	060/60	429	461	461	483
104/104	080/80	502	541	541	569
104/104	090/90	573	616	616	645
104/104	100/100	624	664	664	696
104/104	120/120	640	686	686	719
104/104	140/140	721	775	775	805
104/104	150/150	798	859	859	893
104/104	160/160	875	944	944	980
104/104	180/180	952	1029	1029	1068
119/119	060/60	461	496	496	519
119/119	080/80	540	582	582	612
119/119	090/90	616	662	662	694
119/119	100/100	671	714	714	748
119/119	120/120	688	738	738	773
119/119	140/140	775	833	833	866
119/119	150/150	858	924	924	960
119/119	160/160	941	1015	1015	1054
119/119	180/180	1024	1106	1106	1148

Pricing is continued on the following page.

If Mica is specified, add 16

*The above prices apply to panels finished in one fabric grade. If more than one fabric grade is specified on the screen, please refer to your specifying software for exact price

thin panel

M U W M F

Fabric & Metal Bottom, Whiteboard

Top District Std Thin Panel

(Continued)

DIMENSIONS
CM

PRICING*

FABRIC & METAL BOTTOM, WHITEBOARD TOP DISTRICT THIN PANEL, STANDARD PANEL, ELEVATED

H	W	Top Seg. Front, Fabric Grade AA	Top Seg. Front, Fabric Grade A	Top Seg. Front, Fabric COM	Top Seg. Front, Fabric Grade 1
134/134	060/60	498	536	536	561
134/134	080/80	583	629	629	661
134/134	090/90	665	715	715	750
134/134	100/100	725	771	771	808
134/134	120/120	743	797	797	835
134/134	140/140	837	900	900	935
134/134	150/150	927	998	998	1037
134/134	160/160	1016	1096	1096	1138
134/134	180/180	1106	1194	1194	1240
149/149	060/60	538	579	579	605
149/149	080/80	630	679	679	714
149/149	090/90	719	772	772	809
149/149	100/100	783	833	833	872
149/149	120/120	802	861	861	902
149/149	140/140	904	972	972	1010
149/149	150/150	1001	1078	1078	1120
149/149	160/160	1098	1184	1184	1229
149/149	180/180	1119	1290	1290	1339

If Mica is specified, add 16

*The above prices apply to panels finished in one fabric grade. If more than one fabric grade is specified on the screen, please refer to your specifying software for exact price

thin panel

M U F M

Metal Bottom, Fabric Top District Std Thin Panel

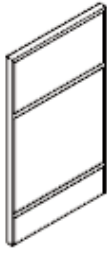

Metal bottom fabric top allows variety of metal and fabric options chosen on top & bottom sections

WHAT'S INCLUDED

1 screen

NOTES

List price for metal segments will default on mica should both foundation & Mica finishes be chosen for bottom segments

114

PRODUCT OPTIONS

Top Style	Base Style	Height	Width	Top Segment Front	Top Segment Back	Bottom Segment Front	Bottom Segment Back	Finish
(1) Standard Panel	(E) Elevated (B) Baseboard	105, 120, 135, 150	06, 08, 09, 10, 12, 14, 15, 16, 18	Grade AA, Grade COM Grade A Grade 1	Grade AA, Grade COM Grade A Grade 1	Foundation Mica	Foundation Mica	Foundation Mica

SAMPLE ORDER CODE

MUFMF 1	E	120	15	J351	X160	Q	7	Q
---------	---	-----	----	------	------	---	---	---

**DIMENSIONS
CM**

PRICING*

METAL BOTTOM, FABRIC TOP DISTRICT THIN PANEL, STANDARD PANEL, BASEBOARD

H	W	Top Seg. Front, Fabric Grade AA	Top Seg. Front, Fabric Grade A	Top Seg. Front, Fabric COM	Top Seg. Front, Fabric Grade 1
104/104	060/60	343	368	368	384
104/104	080/80	403	428	428	453
104/104	090/90	461	486	486	511
104/104	100/100	504	528	528	553
104/104	120/120	516	541	541	566
104/104	140/140	582	607	607	632
104/104	150/150	645	670	670	695
104/104	160/160	708	733	733	758
104/104	180/180	771	796	796	821
119/119	060/60	414	447	447	467
119/119	080/80	486	519	519	549
119/119	090/90	555	588	588	618
119/119	100/100	606	627	627	657
119/119	120/120	620	654	654	684
119/119	140/140	700	737	737	756
119/119	150/150	775	815	815	838
119/119	160/160	850	893	893	920
119/119	180/180	925	971	971	1002

Pricing is continued on the following page.

If Mica is specified, add 16

*The above prices apply to panels finished in one fabric grade. If more than one fabric grade is specified on the screen, please refer to your specifying software for exact price

M U F M

Metal Bottom, Fabric Top District Std
Thin Panel (Continued)DIMENSIONS
CM

PRICING*

METAL BOTTOM, FABRIC TOP DISTRICT THIN PANEL, STANDARD PANEL, BASEBOARD

H	W	Top Seg. Front, Fabric Grade AA	Top Seg. Front, Fabric Grade A	Top Seg. Front, Fabric COM	Top Seg. Front, Fabric Grade 1
134/134	060/60	443	454	454	504
134/134	080/80	519	561	561	586
134/134	090/90	593	635	635	660
134/134	100/100	648	690	690	716
134/134	120/120	662	705	705	730
134/134	140/140	748	788	788	812
134/134	150/150	828	872	872	897
134/134	160/160	908	956	956	982
134/134	180/180	988	1040	1040	1069
149/149	060/60	478	490	490	544
149/149	080/80	561	606	606	633
149/149	090/90	640	686	686	713
149/149	100/100	700	745	745	713
149/149	120/120	715	761	761	788
149/149	140/140	808	851	851	877
149/149	150/150	894	942	942	969
149/149	160/160	981	1032	1032	1061
149/149	180/180	1067	1123	1123	1155
104/104	060/60	343	368	368	384
104/104	080/80	403	428	428	453
104/104	090/90	461	486	486	511
104/104	100/100	504	528	528	553
104/104	120/120	516	541	541	566
104/104	140/140	582	607	607	632
104/104	150/150	645	670	670	695
104/104	160/160	708	733	733	758
104/104	180/180	771	796	796	821
119/119	060/60	414	447	447	467
119/119	080/80	486	519	519	549
119/119	090/90	555	588	588	618
119/119	100/100	606	627	627	657
119/119	120/120	620	654	654	684
119/119	140/140	700	737	737	756
119/119	150/150	775	815	815	838
119/119	160/160	850	893	893	920
119/119	180/180	925	971	971	1002

Pricing is continued on the following page.

If Mica is specified, add 16

*The above prices apply to panels finished in one fabric grade. If more than one fabric grade is specified on the screen, please refer to your specifying software for exact price

thin panel

M U F M

Metal Bottom, Fabric Top District Std Thin Panel (Continued)

DIMENSIONS CM

PRICING*

METAL BOTTOM, FABRIC TOP DISTRICT THIN PANEL, STANDARD PANEL, ELEVATED

H	W	Top Seg. Front, Fabric Grade AA	Top Seg. Front, Fabric Grade A	Top Seg. Front, Fabric COM	Top Seg. Front, Fabric Grade 1
134/134	060/60	443	454	454	504
134/134	080/80	519	561	561	586
134/134	090/90	593	635	635	660
134/134	100/100	648	690	690	716
134/134	120/120	662	705	705	730
134/134	140/140	748	788	788	812
134/134	150/150	828	872	872	897
134/134	160/160	908	956	956	982
134/134	180/180	988	1040	1040	1069
149/149	060/60	478	490	490	544
149/149	080/80	561	606	606	633
149/149	090/90	640	686	686	713
149/149	100/100	700	745	745	713
149/149	120/120	715	761	761	788
149/149	140/140	808	851	851	877
149/149	150/150	894	942	942	969
149/149	160/160	981	1032	1032	1061
149/149	180/180	1067	1123	1123	1155

If Mica is specified, add 16

*The above prices apply to panels finished in one fabric grade. If more than one fabric grade is specified on the screen, please refer to your specifying software for exact price

thin panel

M U W F M

Metal Bottom, Fabric & Whiteboard
Top District Std Thin Panel

Metal bottom with fabric & whiteboard top allows a variety of metal finishes on bottom sections

WHAT'S INCLUDED
1 screen

NOTES
List price for metal segments will default on Mica should both foundation and mica finishes be chosen for bottom segments

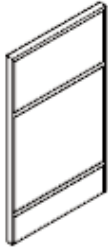

118

PRODUCT OPTIONS

Top Style	Base Style	Height	Width	Top Segment Back	Bottom Segment Front	Bottom Segment Back	Finish
(1) Standard Panel	(E) Elevated (B) Baseboard	105, 120, 135, 150	06, 08, 09, 10, 12, 14, 15, 16, 18	Grade AA, Grade COM Grade A Grade 1	Foundation Mica	Grade AA, Grade COM Grade A Grade 1	Foundation Mica

SAMPLE ORDER CODE

MUWFM 1	E	120	15	J351	Q	7	Q
---------	---	-----	----	------	---	---	---

DIMENSIONS CM

PRICING*

METAL BOTTOM, FABRIC & WHITBOARD TOP DISTRICT THIN PANEL, STANDARD PANEL, BASEBOARD

H	W	Top Seg. Front, Fabric Grade AA	Top Seg. Front, Fabric Grade A	Top Seg. Front, Fabric COM	Top Seg. Front, Fabric Grade 1
104/104	060/60	429	461	461	483
104/104	080/80	502	541	541	569
104/104	090/90	573	616	616	645
104/104	100/100	624	664	664	696
104/104	120/120	640	686	686	719
104/104	140/140	721	775	775	805
104/104	150/150	798	859	859	893
104/104	160/160	875	944	944	980
104/104	180/180	952	1029	1029	1068
119/119	060/60	461	496	496	519
119/119	080/80	540	582	582	612
119/119	090/90	616	662	662	694
119/119	100/100	671	714	714	748
119/119	120/120	688	738	738	773
119/119	140/140	775	833	833	866
119/119	150/150	858	924	924	960
119/119	160/160	941	1015	1015	1054
119/119	180/180	1024	1106	1106	1148

Pricing is continued on the following page.

If Mica is specified, add 16

*The above prices apply to panels finished in one fabric grade. If more than one fabric grade is specified on the screen, please refer to your specifying software for exact price

M U W F M

Metal Bottom, Fabric & Whiteboard Top District Std Thin Panel (Continued)

DIMENSIONS
CM

PRICING*

METAL BOTTOM, FABRIC & WHITEBOARD TOP DISTRICT THIN PANEL, STANDARD PANEL, BASEBOARD

H	W	Top Seg. Front, Fabric Grade AA	Top Seg. Front, Fabric Grade A	Top Seg. Front, Fabric COM	Top Seg. Front, Fabric Grade 1
134/134	060/60	498	536	536	561
134/134	080/80	583	629	629	661
134/134	090/90	665	715	715	750
134/134	100/100	725	771	771	808
134/134	120/120	743	797	797	835
134/134	140/140	837	900	900	935
134/134	150/150	927	998	998	1037
134/134	160/160	1016	1096	1096	1138
134/134	180/180	1106	1194	1194	1240
149/149	060/60	538	579	579	605
149/149	080/80	630	679	679	714
149/149	090/90	719	772	772	809
149/149	100/100	783	833	833	872
149/149	120/120	802	861	861	902
149/149	140/140	904	972	972	1010
149/149	150/150	1001	1078	1078	1120
149/149	160/160	1098	1184	1184	1229
149/149	180/180	1194	1290	1290	1339
104/104	060/60	429	461	461	483
104/104	080/80	502	541	541	569
104/104	090/90	573	616	616	645
104/104	100/100	624	664	664	696
104/104	120/120	640	686	686	719
104/104	140/140	721	775	775	805
104/104	150/150	798	859	859	893
104/104	160/160	875	944	944	980
104/104	180/180	952	1029	1029	1068
119/119	060/60	461	496	496	519
119/119	080/80	540	582	582	612
119/119	090/90	616	662	662	694
119/119	100/100	671	714	714	748
119/119	120/120	688	738	738	773
119/119	140/140	775	833	833	866
119/119	150/150	858	924	924	960
119/119	160/160	941	1015	1015	1054
119/119	180/180	1024	1106	1106	1148

Pricing is continued on the following page.

If Mica is specified, add 16

*The above prices apply to panels finished in one fabric grade. If more than one fabric grade is specified on the screen, please refer to your specifying software for exact price

thin panel

M U W F M

Metal Bottom, Fabric & Whiteboard Top District Std Thin Panel (Continued)

DIMENSIONS CM

PRICING*

METAL BOTTOM, FABRIC & WHITEBOARD TOP DISTRICT THIN PANEL, STANDARD PANEL, ELEVATED

H	W	Top Seg. Front, Fabric Grade AA	Top Seg. Front, Fabric Grade A	Top Seg. Front, Fabric COM	Top Seg. Front, Fabric Grade 1
134/134	060/60	498	536	536	561
134/134	080/80	583	629	629	661
134/134	090/90	665	715	715	750
134/134	100/100	725	771	771	808
134/134	120/120	743	797	797	835
134/134	140/140	837	900	900	935
134/134	150/150	927	998	998	1037
134/134	160/160	1016	1096	1096	1138
134/134	180/180	1106	1194	1194	1240
149/149	060/60	538	579	579	605
149/149	080/80	630	679	679	714
149/149	090/90	719	772	772	809
149/149	100/100	783	833	833	872
149/149	120/120	802	861	861	902
149/149	140/140	904	972	972	1010
149/149	150/150	1001	1078	1078	1120
149/149	160/160	1098	1184	1184	1229
149/149	180/180	1194	1290	1290	1339

If Mica is specified, add 16

*The above prices apply to panels finished in one fabric grade. If more than one fabric grade is specified on the screen, please refer to your specifying software for exact price

thin panel

M U W M

Metal Bottom, Whiteboard Top
District Std Thin Panel

Metal bottom with whiteboard top allows a variety of metal finishes on bottom sections

NOTES

List price for metal segments will default on Mica should both foundation and mica finishes be chosen for bottom segments



122

PRODUCT OPTIONS

Top Style	Base Style	Height	Width	Bottom Segment Front	Bottom Segment Back	Finish
(1) Standard Panel	(E) Elevated (B) Baseboard	105, 120, 135, 150	06, 08, 09, 10, 12, 14, 15, 16, 18	Foundation Mica	Foundation Mica	Foundation Mica

SAMPLE ORDER CODE

MUWM 1	E	135	16	7	Q	Q
--------	---	-----	----	---	---	---

DIMENSIONS
CM

PRICING*

METAL BOTTOM, WHITEBOARD TOP DISTRICT THIN PANEL, STANDARD PANEL, BASEBOARD

H	W	Bottom Seg. Front, Foundation Colour	Bottom Seg. Front, Mica Colour	Bottom Seg. Back, Foundation Colour	Bottom Seg. Back, Mica Colour
104/104	060/60	464	501	0	32
104/104	080/80	540	577	0	32
104/104	090/90	612	649	0	32
104/104	100/100	667	704	0	32
104/104	120/120	681	719	0	32
104/104	140/140	765	803	0	32
104/104	150/150	845	884	0	32
104/104	160/160	925	965	0	32
104/104	180/180	1005	1046	0	32
119/119	060/60	469	506	0	32
119/119	080/80	545	582	0	32
119/119	090/90	618	656	0	32
119/119	100/100	659	697	0	32
119/119	120/120	687	725	0	32
119/119	140/140	775	812	0	32
119/119	150/150	856	895	0	32
119/119	160/160	937	978	0	32
119/119	180/180	1018	1061	0	32

Pricing is continued on the following page.

If Mica is specified, add 32

*The above prices apply to panels finished in one fabric grade. If more than one fabric grade is specified on the screen, please refer to your specifying software for exact price

Metal Bottom, Whiteboard Top District Std Thin Panel (Continued)

DIMENSIONS CM

PRICING*

METAL BOTTOM, WHITEBOARD TOP DISTRICT THIN PANEL, STANDARD PANEL, BASEBOARD

H	W	Bottom Seg. Front, Foundation Colour	Bottom Seg. Front, Mica Colour	Bottom Seg. Back, Foundation Colour	Bottom Seg. Back, Mica Colour
134/134	060/60	477	514	0	32
134/134	080/80	590	627	0	32
134/134	090/90	668	706	0	32
134/134	100/100	725	763	0	32
134/134	120/120	741	778	0	32
134/134	140/140	827	865	0	32
134/134	150/150	915	954	0	32
134/134	160/160	1003	1043	0	32
134/134	180/180	1091	1132	0	32
149/149	060/60	515	555	0	32
149/149	080/80	637	677	0	32
149/149	090/90	721	762	0	32
149/149	100/100	783	824	0	32
149/149	120/120	800	840	0	32
149/149	140/140	893	934	0	32
149/149	150/150	988	1030	0	32
149/149	160/160	1083	1126	0	32
149/149	180/180	1178	1223	0	32
104/104	060/60	464	501	0	32
104/104	080/80	540	577	0	32
104/104	090/90	612	649	0	32
104/104	100/100	667	704	0	32
104/104	120/120	681	719	0	32
104/104	140/140	765	803	0	32
104/104	150/150	845	884	0	32
104/104	160/160	925	965	0	32
104/104	180/180	1005	1046	0	32
119/119	060/60	469	506	0	32
119/119	080/80	545	582	0	32
119/119	090/90	618	656	0	32
119/119	100/100	659	697	0	32
119/119	120/120	687	725	0	32
119/119	140/140	775	812	0	32
119/119	150/150	856	895	0	32
119/119	160/160	937	978	0	32
119/119	180/180	1018	1061	0	32

Pricing is continued on the following page.

If Mica is specified, add 32

*The above prices apply to panels finished in one fabric grade. If more than one fabric grade is specified on the screen, please refer to your specifying software for exact price

thin panel

M U W M

Metal Bottom, Whiteboard Top District StdThin Panel (Continued)

DIMENSIONS CM

PRICING*

METAL BOTTOM, WHITEBOARD TOP DISTRICT THIN PANEL, STANDARD PANEL, BASEBOARD

H	W	Bottom Seg. Front, Foundation Colour	Bottom Seg. Front, Mica Colour	Bottom Seg. Back, Foundation Colour	Bottom Seg. Back, Mica Colour
134/134	060/60	477	514	0	32
134/134	080/80	590	627	0	32
134/134	090/90	668	706	0	32
134/134	100/100	725	763	0	32
134/134	120/120	741	778	0	32
134/134	140/140	827	865	0	32
134/134	150/150	915	954	0	32
134/134	160/160	1003	1043	0	32
134/134	180/180	1091	1132	0	32
149/149	060/60	515	555	0	32
149/149	080/80	637	677	0	32
149/149	090/90	721	762	0	32
149/149	100/100	783	824	0	32
149/149	120/120	800	840	0	32
149/149	140/140	893	934	0	32
149/149	150/150	988	1030	0	32
149/149	160/160	1083	1126	0	32
149/149	180/180	1178	1223	0	32

If Mica is specified, add 32

*The above prices apply to panels finished in one fabric grade. If more than one fabric grade is specified on the screen, please refer to your specifying software for exact price

thin panel

M U A G Glaze Add-On Screen

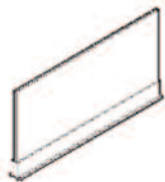

The Glaze add on screen is added on top of the panels to provide a lighter, frameless alternative to windows

WHAT'S INCLUDED

1 Add on Screen with attachment hardware

NOTES

Standard glass clear is tempered glass finish

standard glass frosted is a tempered etched glass

126

PRODUCT OPTIONS

Height	Width (15cm increments)	Segment
015, 030	06, 08, 09, 10, 12, 14, 15, 16, 18	Clear Frost

SAMPLE ORDER CODE

MUAG 015	16	5
----------	----	---

DIMENSIONS CM

H	W
015/015	060/60
015/015	080/80
015/015	090/90
015/015	100/100
015/015	120/120
015/015	140/140
015/015	150/150
015/015	160/160
015/015	180/180
030/030	060/60
030/030	080/80
030/030	090/90
030/030	100/100
030/030	120/120
030/030	140/140
030/030	150/150
030/030	160/160
030/030	180/180

PRICING*

GLAZE DISTRICT ADD-ON PANEL

	Clear Glass	Frosted Glass
015/015 060/60	176	267
015/015 080/80	203	299
015/015 090/90	240	341
015/015 100/100	273	381
015/015 120/120	305	418
015/015 140/140	336	455
015/015 150/150	369	493
015/015 160/160	401	533
015/015 180/180	432	568
030/030 060/60	203	309
030/030 080/80	241	354
030/030 090/90	277	400
030/030 100/100	314	445
030/030 120/120	349	488
030/030 140/140	386	536
030/030 150/150	423	579
030/030 160/160	460	626
030/030 180/180	496	603

Fabric monolithic panel allow variety as fabric options to be chosen on both sides

M U M A F

WHAT'S INCLUDED

1 screen

Fabric District Monolithic Panel

NOTES

List price for panel fabric with difference fabric grade combinations will default on the higher grade of fabric chosen



PRODUCT OPTIONS

Top Style	Base Style	Height	Width	Segment Front	Segment Back	Finish
(1) Standard Panel	(E) Elevated (B) Baseboard	105, 120	06, 08, 09, 10, 12,	Grade AA, Grade COM Grade A Grade 1	Grade AA Grade COM Grade A Grade 1	Foundation Mica

127

SAMPLE ORDER CODE

MUMAF 1	E	120	10	X160	G	Q
---------	---	-----	----	------	---	---

DIMENSIONS
CM

PRICING*

FABRIC DISTRICT MONOLITHIC PANEL, STANDARD PANEL, BASEBOARD

H	W	Seg. Front, Fabric Grade AA	Seg. Front, Fabric Grade A	Seg. Front, Fabric COM	Seg. Front, Fabric Grade 1
104/104	060/60	351	375	375	392
104/104	080/80	411	443	443	465
104/104	090/90	469	508	508	532
104/104	100/100	512	553	553	580
104/104	120/120	524	569	569	597
119/119	060/60	424	456	456	477
119/119	080/80	496	539	539	563
119/119	090/90	565	616	616	645
119/119	100/100	616	670	670	701
119/119	120/120	630	689	689	722

FABRIC DISTRICT MONOLITHIC PANEL, STANDARD PANEL, ELEVATED

104/104	060/60	351	375	375	392
104/104	080/80	411	443	443	465
104/104	090/90	469	508	508	532
104/104	100/100	512	553	553	580
104/104	120/120	524	569	569	597
119/119	060/60	424	456	456	477
119/119	080/80	496	539	539	563
119/119	090/90	565	616	616	645
119/119	100/100	616	670	670	701
119/119	120/120	630	689	689	722

If Mica is specified, add 16

*The above prices apply to panels finished in one fabric grade. If more than one fabric grade is specified on the screen, please refer to your specifying software for exact price

thin panel

MUMFM

Fabric & Metal District Monolithic Panel



Fabric & Metal Monolithic panel allow variety of fabric & metal finishes to be chosen on both sides

WHAT'S INCLUDED

1 screen

NOTES

List price for metal segments will default on Mica should both foundation and mica finishes be chosen for bottom segments

PRODUCT OPTIONS

Top Style	Base Style	Height	Width	Segment Front	Segment Back	Finish
(1) Standard Panel	(E) Elevated (B) Baseboard	105, 120	06, 08, 09, 10, 12,	Grade AA, Grade COM Grade A Grade 1	Grade AA Grade COM Grade A Grade 1	Foundation Mica

128

SAMPLE ORDER CODE

MUMFM 1	E	120	10	X160	G	Q
---------	---	-----	----	------	---	---

**DIMENSIONS
CM**

PRICING*

FABRIC & METAL DISTICT MONOLITHIC PANEL, STANDARD PANEL, BASEBOARD

H	W	Seg. Front, Fabric Grade AA	Seg. Front, Fabric Grade A	Seg. Back, Fabric COM	Seg. Back, Fabric Grade 1
104/104	060/60	343	368	368	384
104/104	080/80	403	428	428	453
104/104	090/90	461	486	486	511
104/104	100/100	504	528	528	553
104/104	120/120	516	541	541	566
119/119	060/60	414	447	447	467
119/119	080/80	486	519	519	549
119/119	090/90	555	588	588	618
119/119	100/100	606	627	627	657
119/119	120/120	620	654	654	684

FABRIC & METAL DISTICT MONOLITHIC PANEL, STANDARD PANEL, ELEVATED

104/104	060/60	343	368	368	384
104/104	080/80	403	428	428	453
104/104	090/90	461	486	486	511
104/104	100/100	504	528	528	553
104/104	120/120	516	541	541	566
119/119	060/60	414	447	447	467
119/119	080/80	486	519	519	549
119/119	090/90	555	588	588	618
119/119	100/100	606	627	627	657
119/119	120/120	620	654	654	684

If Mica is specified, add 32

*The above prices apply to panels finished in one fabric grade. If more than one fabric grade is specified on the screen, please refer to your specifying software for exact price

Metal Monolithic screen allows variety of metal finishes on both side

WHAT'S INCLUDED

1 screen

NOTES

List price for metal segments will default on Mica should both foundation and mica finishes be chosen for bottom segments

M U M A M Metal District Monolithic Panel



PRODUCT OPTIONS

Top Style	Base Style	Height	Width	Segment Front	Segment Back	Frame Finish
(1) Standard Panel	(E) Elevated (B) Baseboard	105, 120	06, 08, 09, 10, 12,	Foundation Mica	Foundation Mica	Foundation Mica

SAMPLE ORDER CODE

MUMAM 1	E	105	12	7	Q	Q
---------	---	-----	----	---	---	---

**DIMENSIONS
CM**

PRICING*

METAL DISTRICT MONOLITHIC PANEL, STANDARD PANEL, BASEBOARD

H	W	Seg. Front, Foundation Colour
104/104	060/60	333
104/104	080/80	390
104/104	090/90	446
104/104	100/100	486
104/104	120/120	498
119/119	060/60	403
119/119	080/80	471
119/119	090/90	537
119/119	100/100	585
119/119	120/120	599

METAL DISTRICT MONOLITHIC PANEL, STANDARD PANEL, ELEVATED

104/104	060/60	333
104/104	080/80	390
104/104	090/90	446
104/104	100/100	486
104/104	120/120	498
119/119	060/60	403
119/119	080/80	471
119/119	090/90	537
119/119	100/100	585
119/119	120/120	599

If Segment Front, Mica is specified, add 32
 If Segment Back, Mica is specified, add 32
 If Mica is specified, add 32

*The above prices apply to panels finished in one fabric grade. If more than one fabric grade is specified on the screen, please refer to your specifying software for exact price

thin panel

MUMFW

Fabric & Whiteboard District Monolithic Panel

Fabric & whiteboard monolithic screen allow variety of fabric option to be chosen on 1 side

WHAT'S INCLUDED
1 screen

NOTES
List price for metal segments will default on Mica should both foundation and mica finishes be chosen for bottom segments



PRODUCT OPTIONS

Top Style	Base Style	Height	Width	Segment Front	Finish
(1) Standard Panel	(E) Elevated (B) Baseboard	105, 120	06 ,08, 09, 10, 12,	Grade AA, Grade COM Grade A Grade 1	Foundation Mica

SAMPLE ORDER CODE

MUMFW 1	E	120	12	X160	Q
---------	---	-----	----	------	---

DIMENSIONS CM

PRICING*

FABRIC & WHITEBOARD DISTRICT MONOLITHIC PANEL, STANDARD PANEL, BASEBOARD

H	W	Seg. Front, Fabric Grade AA	Seg. Front, Fabric Grade A	Seg. Back, Fabric COM	Seg. Back, Fabric Grade 1
104/104	060/60	462	495	495	517
104/104	080/80	541	586	586	614
104/104	090/90	618	670	670	703
104/104	100/100	674	731	731	766
104/104	120/120	689	752	752	788
119/119	060/60	468	502	502	525
119/119	080/80	546	593	593	621
119/119	090/90	622	677	677	709
119/119	100/100	679	737	737	772
119/119	120/120	695	758	758	794

FABRIC & WHITEBOARD DISTRICT MONOLITHIC PANEL, STANDARD PANEL, ELEVATED

104/104	060/60	462	495	495	517
104/104	080/80	541	586	586	614
104/104	090/90	618	670	670	703
104/104	100/100	674	731	731	766
104/104	120/120	689	752	752	788
119/119	060/60	468	502	502	525
119/119	080/80	546	593	593	621
119/119	090/90	622	677	677	709
119/119	100/100	679	737	737	772
119/119	120/120	695	758	758	794

Whiteboard monolithic screen allow the flexibility to have full height & writing capability

M U M A W

WHAT'S INCLUDED
1 screen

Whiteboard District Monolithic Panel

NOTES
Whiteboard are painted whiteboards



PRODUCT OPTIONS

Top Style	Base Style	Height	Width	Finish
(1) Standard Panel	(E) Elevated (B) Baseboard	105, 120	06, 08, 09, 10, 12	Foundation Mica

131

SAMPLE ORDER CODE

MUMAW 1	E	120	12	Q
---------	---	-----	----	---

DIMENSIONS CM

PRICING*

WHITEBOARD DISTRICT MONOLITHIC PANEL, STANDARD PANEL, BASEBOARD

H	W	Foundation Colour	Mica Colour
104/104	060/60	517	533
104/104	080/80	614	630
104/104	090/90	703	719
104/104	100/100	766	782
104/104	120/120	788	804
119/119	060/60	525	541
119/119	080/80	621	637
119/119	090/90	709	725
119/119	100/100	772	788
119/119	120/120	794	810

WHITEBOARD DISTRICT MONOLITHIC PANEL, STANDARD PANEL, ELEVATED

104/104	060/60	517	533
104/104	080/80	614	630
104/104	090/90	703	719
104/104	100/100	766	782
104/104	120/120	788	804
119/119	060/60	525	541
119/119	080/80	621	637
119/119	090/90	709	725
119/119	100/100	772	788
119/119	120/120	794	810

thin panel

MUMAG

Glaze District Monolithic Panel



Glaze Monolithic panel allow the flexibility of full length of transparency

WHAT'S INCLUDED

1

Standard glass clear is tempered glass finish

standard glass frosted is a tempered etched glass

PRODUCT OPTIONS

Top Style	Base Style	Height	Width	Segment	Finish
(1) Standard Panel	(E) Elevated (B) Baseboard	105, 120	06, 08, 09, 10, 12	Clear Frost	Foundation Mica

SAMPLE ORDER CODE

MUMAG 1	E	120	12	5	Q
---------	---	-----	----	---	---

DIMENSIONS

CM

PRICING*

GLAZE DISTRICT MONOLITHIC PANEL, STANDARD PANEL, BASEBOARD

H	W	Clear Glass	Mica Colour
104/104	060/60	462	517
104/104	080/80	541	614
104/104	090/90	618	703
104/104	100/100	674	766
104/104	120/120	689	788
119/119	060/60	468	525
119/119	080/80	546	621
119/119	090/90	622	709
119/119	100/100	679	772
119/119	120/120	695	794

GLAZE DISTRICT MONOLITHIC PANEL, STANDARD PANEL, ELEVATED

104/104	060/60	462	517
104/104	080/80	541	614
104/104	090/90	618	703
104/104	100/100	674	766
104/104	120/120	689	788
119/119	060/60	468	525
119/119	080/80	546	621
119/119	090/90	622	709
119/119	100/100	679	772
119/119	120/120	695	794

If Frosted is specified, add 74

If Mica is specified, add 16

*The above prices apply to panels finished in one fabric grade. If more than one fabric grade is specified on the screen, please refer to your specifying software for exact price

thin panel

MUGF

Fabric Bottom & Glaze Top District Thin Panel



Fabric bottom & Glaze top allows variety of fabric options to be chosen at bottom and 2 type of glaze finishes on top

WHAT'S INCLUDED

1 screen

NOTES

List price for panel fabric with difference fabric grade combinations will default on the higher grade of fabric chosen

Standard glass clear is tempered glass finish
standard glass frosted is a tempered etched glass

134

PRODUCT OPTIONS

Top Style	Base Style	Height	Width	Top Segment Back	Bottom Segment Front	Bottom Segment Back	Finish
(1) Standard Panel	(E) Elevated (B) Baseboard	105, 120, 135, 150	06, 08, 09, 10, 12, 14, 15, 16, 18	Clear Frost	Grade AA Grade COM Grade A Grade 1	Grade AA Grade COM Grade A Grade 1	Foundation Mica

SAMPLE ORDER CODE

MUGF 1	E	150	18	5	J351	J351	Q
--------	---	-----	----	---	------	------	---

DIMENSIONS CM

PRICING*

FABRIC BOTTOM & GLAZE TOP DISTRICT THIN PANEL, STANDARD PANEL, BASEBOARD

H	W	Bottom Seg. Front, Fabric Grade AA	Bottom Seg. Front, Fabric Grade A	Bottom Seg. Front, Fabric COM	Bottom Seg. Front, Fabric Grade 1
104/104	060/60	424	454	454	475
104/104	080/80	496	537	537	564
104/104	090/90	566	614	614	644
104/104	100/100	617	669	669	702
104/104	120/120	633	689	689	723
104/104	140/140	712	777	777	819
104/104	150/150	788	865	865	909
104/104	160/160	864	953	953	999
104/104	180/180	940	1041	1041	1089
119/119	060/60	428	461	461	480
119/119	080/80	501	543	543	568
119/119	090/90	571	622	622	649
119/119	100/100	622	676	676	707
119/119	120/120	637	695	695	728
119/119	140/140	717	785	785	824
119/119	150/150	794	872	872	915
119/119	160/160	871	959	959	1006
119/119	180/180	948	1046	1046	1097

Pricing is continued on the following page.

If Mica is specified, add 16
If Frosted is specified, add 74

*The above prices apply to panels finished in one fabric grade. If more than one fabric grade is specified on the screen, please refer to your specifying software for exact price

Fabric Bottom & Glaze Top District Thin Panel (Continued)

DIMENSIONS
CM

PRICING*

FABRIC BOTTOM & GLAZE TOP DISTRICT THIN PANEL, STANDARD PANEL, BASEBOARD

H	W	Bottom Seg. Front, Fabric Grade AA	Bottom Seg. Front, Fabric Grade A	Bottom Seg. Front, Fabric COM	Bottom Seg. Front, Fabric Grade 1
134/134	060/60	462	473	454	475
134/134	080/80	540	586	537	564
134/134	090/90	615	668	614	644
134/134	100/100	670	728	669	702
134/134	120/120	685	746	689	723
134/134	140/140	771	842	777	819
134/134	150/150	852	934	865	909
134/134	160/160	933	1026	953	999
134/134	180/180	1014	1118	1041	1089
149/149	060/60	499	511	511	525
149/149	080/80	583	633	633	661
149/149	090/90	664	721	721	755
149/149	100/100	724	786	786	822
149/149	120/120	740	806	806	846
149/149	140/140	833	909	909	956
149/149	150/150	920	1009	1009	1061
149/149	160/160	1008	1108	1108	1165
149/149	180/180	1095	1207	1207	1270
104/104	060/60	424	454	454	475
104/104	080/80	496	537	537	564
104/104	090/90	566	614	614	644
104/104	100/100	617	669	669	702
104/104	120/120	633	689	689	723
104/104	140/140	712	777	777	819
104/104	150/150	788	865	865	909
104/104	160/160	864	953	953	999
104/104	180/180	940	1041	1041	1089
119/119	060/60	428	461	461	480
119/119	080/80	501	543	543	568
119/119	090/90	571	622	622	649
119/119	100/100	622	676	676	707
119/119	120/120	637	695	695	728
119/119	140/140	717	785	785	824
119/119	150/150	794	872	872	915
119/119	160/160	871	959	959	1006
119/119	180/180	948	1046	1046	1097

Pricing is continued on the following page.

If Mica is specified, add 32

*The above prices apply to panels finished in one fabric grade. If more than one fabric grade is specified on the screen, please refer to your specifying software for exact price

thin panel

MUGF

Fabric Bottom & Glaze Top District Thin Panel (Continued)

DIMENSIONS
CM

PRICING*

FABRIC BOTTOM & GLAZE TOP DISTRICT THIN PANEL, STANDARD PANEL, ELEVATED

H	W	Bottom Seg. Front, Fabric Grade AA	Bottom Seg. Front, Fabric Grade A	Bottom Seg. Front, Fabric COM	Bottom Seg. Front, Fabric Grade 1
134/134	060/60	462	473	454	475
134/134	080/80	540	586	537	564
134/134	090/90	615	668	614	644
134/134	100/100	670	728	669	702
134/134	120/120	685	746	689	723
134/134	140/140	771	842	777	819
134/134	150/150	852	934	865	909
134/134	160/160	933	1026	953	999
134/134	180/180	1014	1118	1041	1089
149/149	060/60	499	511	511	525
149/149	080/80	583	633	633	661
149/149	090/90	664	721	721	755
149/149	100/100	724	786	786	822
149/149	120/120	740	806	806	846
149/149	140/140	833	909	909	956
149/149	150/150	920	1009	1009	1061
149/149	160/160	1008	1108	1108	1165
149/149	180/180	1095	1207	1207	1270

If Mica is specified, add 32

*The above prices apply to panels finished in one fabric grade. If more than one fabric grade is specified on the screen, please refer to your specifying software for exact price

136

thin panel

MUGMF

Fabric & Metal Bottom, Glaze Top District Thin Panel



Fabric & metal bottom, Glaze top allows two option of glaze on top sections

WHAT'S INCLUDED
1 screen

NOTES

List price for panel fabric with difference fabric grade combinations will default on the higher grade of fabric chosen

Standard glass clear is tempered glass finish
standard glass frosted is a tempered etched glass

138

PRODUCT OPTIONS

Top Style	Base Style	Height	Width	Top Segment Back	Bottom Segment Front	Bottom Segment Back	Finish
(1) Standard Panel	(E) Elevated (B) Baseboard	105, 120, 135, 150	06, 08, 09, 10, 12, 14, 15, 16, 18	Clear Frost	Foundation Mica	Grade AA, Grade COM Grade A Fabric Grade 1	Foundation Mica

SAMPLE ORDER CODE

MUGMF 1	E	105	12	5	7	X160	Q
---------	---	-----	----	---	---	------	---

DIMENSIONS CM

PRICING*

FABRIC & METAL BOTTOM, GLAZE TOP DISTRICT THIN PANEL, STANDARD PANEL, BASEBOARD

H	W	Bottom Seg.	Bottom Seg.	Bottom Seg.	Bottom Seg.
		Front, Fabric Grade AA	Front, Fabric Grade A	Front, Fabric COM	Front, Fabric Grade 1
104/104	060/60	424	454	454	473
104/104	080/80	495	536	536	563
104/104	090/90	566	613	613	643
104/104	100/100	617	668	668	701
104/104	120/120	632	688	688	721
104/104	140/140	712	775	775	817
104/104	150/150	788	863	863	906
104/104	160/160	854	951	951	995
104/104	180/180	940	1039	1039	1084
119/119	060/60	428	460	460	480
119/119	080/80	501	543	543	568
119/119	090/90	570	620	620	648
119/119	100/100	621	674	674	706
119/119	120/120	637	693	693	726
119/119	140/140	717	783	783	821
119/119	150/150	793	869	869	910
119/119	160/160	869	955	955	999
119/119	180/180	945	1041	1041	1088

Pricing is continued on the following page.

If Mica is specified, add 32

*The above prices apply to panels finished in one fabric grade. If more than one fabric grade is specified on the screen, please refer to your specifying software for exact price

M U G M F

Fabric & Metal Bottom, Glaze Top District Thin Panel (Continued)

DIMENSIONS

CM

PRICING*

FABRIC & METAL BOTTOM, GLAZE TOP DISTRICT THIN PANEL, STANDARD PANEL, BASEBOARD

H	W	Bottom Seg. Front, Fabric Grade AA	Bottom Seg. Front, Fabric Grade A	Bottom Seg. Front, Fabric COM	Bottom Seg. Front, Fabric Grade 1
134/134	060/60	461	472	472	484
134/134	080/80	540	585	585	611
134/134	090/90	615	667	667	697
134/134	100/100	669	726	726	758
134/134	120/120	684	744	744	780
134/134	140/140	770	840	840	882
134/134	150/150	852	931	931	978
134/134	160/160	934	1022	1022	1074
134/134	180/180	1016	1113	1113	1170
149/149	060/60	498	510	510	523
149/149	080/80	583	632	632	660
149/149	090/90	664	720	720	753
149/149	100/100	723	784	784	819
149/149	120/120	739	804	804	842
149/149	140/140	832	907	907	953
149/149	150/150	920	1005	1005	1056
149/149	160/160	1009	1104	1104	1160
149/149	180/180	1097	1202	1202	1264
104/104	060/60	424	454	454	473
104/104	080/80	495	536	536	563
104/104	090/90	566	613	613	643
104/104	100/100	617	668	668	701
104/104	120/120	632	688	688	721
104/104	140/140	712	775	775	817
104/104	150/150	788	863	863	906
104/104	160/160	854	951	951	995
104/104	180/180	940	1039	1039	1084
119/119	060/60	428	460	460	480
119/119	080/80	501	543	543	568
119/119	090/90	570	620	620	648
119/119	100/100	621	674	674	706
119/119	120/120	637	693	693	726
119/119	140/140	717	783	783	821
119/119	150/150	793	869	869	910
119/119	160/160	869	955	955	999
119/119	180/180	945	1041	1041	1088

Pricing is continued on the following page.

If Mica is specified, add 32

*The above prices apply to panels finished in one fabric grade. If more than one fabric grade is specified on the screen, please refer to your specifying software for exact price

thin panel

M U G M F

Fabric & Metal Bottom, Glaze Top District Thin Panel (Continued)

DIMENSIONS CM

PRICING*

FABRIC & METAL BOTTOM, GLAZE TOP DISTRICT THIN PANEL, STANDARD PANEL, ELEVATED

H	W	Bottom Seg. Front, Fabric Grade AA	Bottom Seg. Front, Fabric Grade A	Bottom Seg. Front, Fabric COM	Bottom Seg. Front, Fabric Grade 1
134/134	060/60	461	472	472	484
134/134	080/80	540	585	585	611
134/134	090/90	615	667	667	697
134/134	100/100	669	726	726	758
134/134	120/120	684	744	744	780
134/134	140/140	770	840	840	882
134/134	150/150	852	931	931	978
134/134	160/160	934	1022	1022	1074
134/134	180/180	1016	1113	1113	1170
149/149	060/60	498	510	510	523
149/149	080/80	583	632	632	660
149/149	090/90	664	720	720	753
149/149	100/100	723	784	784	819
149/149	120/120	739	804	804	842
149/149	140/140	832	907	907	953
149/149	150/150	920	1005	1005	1056
149/149	160/160	1009	1104	1104	1160
149/149	180/180	1097	1202	1202	1264

If Mica is specified, add 32

*The above prices apply to panels finished in one fabric grade. If more than one fabric grade is specified on the screen, please refer to your specifying software for exact price

thin panel

M U G M

Metal Bottom, Glaze Top District Thin Panel



Metal bottom, Glaze top allow variety of metals finishes on bottom segment and 2 type of glaze options for segments

WHAT'S INCLUDED

1 screen

NOTES

NOTES

List price for panel fabric with difference fabric grade combinations will default on the higher grade of fabric chosen

Standard glass clear is tempered glass finish
standard glass frosted is a tempered etched glass

142

PRODUCT OPTIONS

Top Style	Base Style	Height	Width	Top Segment Back	Bottom Segment Front	Bottom Segment Back	Finish
(1) Standard Panel	(E) Elevated (B) Baseboard	105, 120, 135, 150	06, 08, 09, 10, 12, 14, 15, 16, 18	Clear Frost	Foundation Mica	Foundation Mica	Foundation Mica

SAMPLE ORDER CODE

MUGM 1	E	120	16	5	7	7	Q
--------	---	-----	----	---	---	---	---

DIMENSIONS CM

PRICING*

METAL BOTTOM, GLAZE TOP DISTRICT THIN PANEL, STANDARD PANEL, BASEBOARD

H	W	Bottom Seg. Front, Foundation Colour	Bottom Seg. Front, Mica Colour
104/104	060/60	444	481
104/104	080/80	516	553
104/104	090/90	586	624
104/104	100/100	637	675
104/104	120/120	652	690
104/104	140/140	733	770
104/104	150/150	809	846
104/104	160/160	885	922
104/104	180/180	961	998
119/119	060/60	449	486
119/119	080/80	521	559
119/119	090/90	591	629
119/119	100/100	629	667
119/119	120/120	658	696
119/119	140/140	741	778
119/119	150/150	820	858
119/119	160/160	899	938
119/119	180/180	978	1018

Pricing is continued on the following page.

If Mica is specified, add 32

*The above prices apply to panels finished in one fabric grade. If more than one fabric grade is specified on the screen, please refer to your specifying software for exact price

Metal Bottom, Glaze Top District
Thin Panel (Continued)DIMENSIONS
CM

PRICING*

FABRIC & METAL BOTTOM, GLAZE TOP DISTRICT THIN PANEL, STANDARD PANEL, ELEVATED

H	W	Bottom Seg. Front, Foundation Colour	Bottom Seg. Front, Mica Colour
134/134	060/60	457	494
134/134	080/80	563	601
134/134	090/90	638	676
134/134	100/100	694	732
134/134	120/120	709	746
134/134	140/140	790	829
134/134	150/150	876	913
134/134	160/160	962	997
134/134	180/180	1048	1081
149/149	060/60	494	534
149/149	080/80	608	649
149/149	090/90	689	730
149/149	100/100	750	791
149/149	120/120	766	806
149/149	140/140	853	895
149/149	150/150	946	986
149/149	160/160	1039	1077
149/149	180/180	1132	1167
104/104	060/60	444	481
104/104	080/80	516	553
104/104	090/90	586	624
104/104	100/100	637	675
104/104	120/120	652	690
104/104	140/140	733	770
104/104	150/150	809	846
104/104	160/160	885	922
104/104	180/180	961	998
119/119	060/60	449	486
119/119	080/80	521	559
119/119	090/90	591	629
119/119	100/100	629	667
119/119	120/120	658	696
119/119	140/140	741	778
119/119	150/150	820	858
119/119	160/160	899	938
119/119	180/180	978	1018

If Mica is specified, add 32

Pricing is continued on the following page.

*The above prices apply to panels finished in one fabric grade. If more than one fabric grade is specified on the screen, please refer to your specifying software for exact price

thin panel

M U G M

Metal Bottom, Glaze Top District Thin Panel (Continued)

DIMENSIONS CM

PRICING*

FABRIC & METAL BOTTOM, GLAZE TOP DISTRICT THIN PANEL, STANDARD PANEL, ELEVATED

H	W	Bottom Seg. Front, Foundation Colour	Bottom Seg. Front, Mica Colour
134/134	060/60	457	494
134/134	080/80	563	601
134/134	090/90	638	676
134/134	100/100	694	732
134/134	120/120	709	746
134/134	140/140	790	829
134/134	150/150	876	913
134/134	160/160	962	997
134/134	180/180	1048	1081
149/149	060/60	494	534
149/149	080/80	608	649
149/149	090/90	689	730
149/149	100/100	750	791
149/149	120/120	766	806
149/149	140/140	853	895
149/149	150/150	946	986
149/149	160/160	1039	1077
149/149	180/180	1132	1167

If Mica is specified, add 32

*The above prices apply to panels finished in one fabric grade. If more than one fabric grade is specified on the screen, please refer to your specifying software for exact price

144

screens

screens

PRODUCT MAP / TABLE OF CONTENTS	147
SCREENS OVERVIEW	150
DESK TOP SCREEN BASICS	151
MODESTY AND PANEL WALL ADD-ON BASICS	152
PRODUCT LISTING	154

product map

MUNSDT Desk Top Casual Screen

Page 154
Height: 30cm/ Width: 60cm

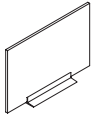

MUNSBWS Desk Top Mounted Screen

Page 155
Height: 30cm / Width: 50cm, 60cm, 70cm, 80cm

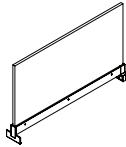

MUNSM Modesty Screen

Page 156
Height: 33cm
Width: 60cm - 240cm



MUNSPG Panel Wall Add-On Screen – Glass

Page 157
Height: 15cm, 30cm, 45cm
Width: 60cm - 240cm

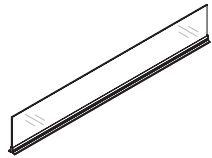

screens overview

District provides a variety of screens for space division in panel wall and freestanding applications. They provide visual and territorial privacy and a lighter aesthetic than a panel wall in areas where electrical shielded wire management is not required.

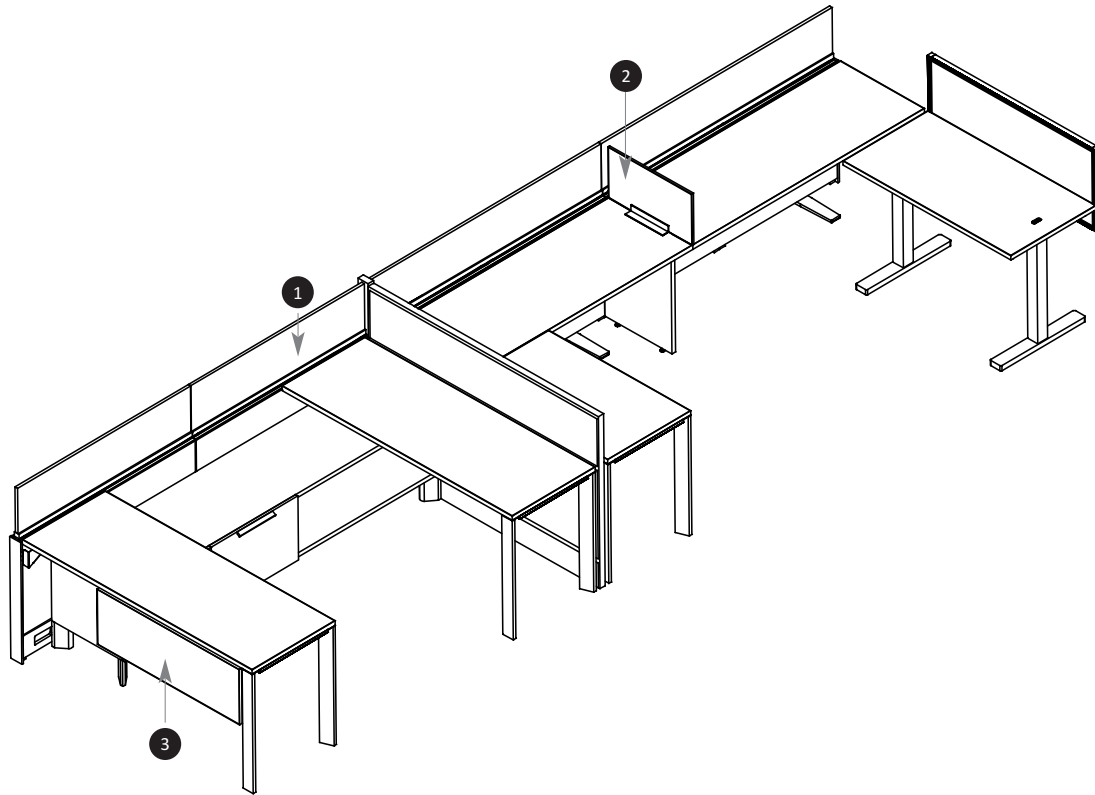

150

- 1 Panel Wall Add-On Screens offer a lighter, frameless on- or off-module alternative to window panels
- 2 Desk Top Casual Screens and Desk Mounted Screens provide territorial privacy between users
 - The Desk Top Casual Screen is freestanding for easy relocation within a workstation
 - The Desk Top Mounted Screen clamps to the front of a worksurface for a more secure attachment
- 3 Modesty Screens provide privacy below desk level to 250cm above the floor

desk top screen basics

The following outlines the features of the Desk Top Casual Screen and Desk Top Mounted Screen.

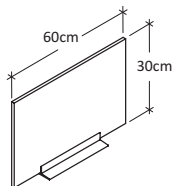
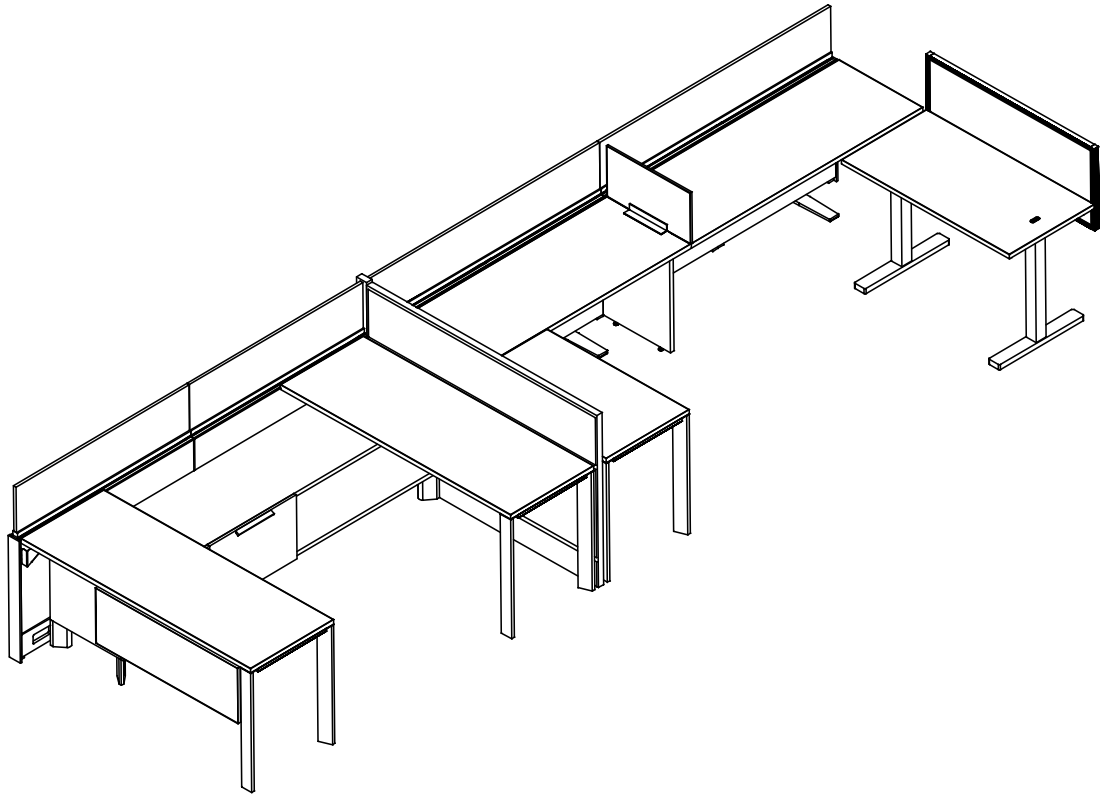

Desk Top Casual Screen (MUNSDT)

- A freestanding screen to be used for perpendicular territorial screening
- Intended to sit on the top of the worksurface but is not mounted, so can be repositioned
- Matches 105cm high datum line
- Can be used at the ends of worksurfaces, or between users anywhere along the length of the worksurface
- An ideal solution for space division in “Benching” applications where various numbers of users occupy the workstation
- Available in Source Laminate

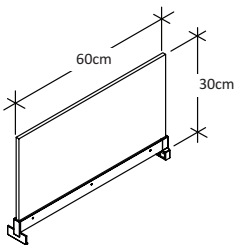

Desk Top Mounted Screen (MUNSBWS)

- A mounted screen used for perpendicular territorial screening
- Matches 105cm high datum
- Is specified to match the depth of the worksurface as it clamps to the front and rear of the worksurface
- Can be used between users on-module or off-module, but not at the end of a run
- Available in Source Laminate, Standard Frosted Glass, Frosted Etched Tempered is an etched tempered glass
- Can only be used on rectangular worksurfaces

modesty and panel wall add-on basics

The following outlines the features of the Modesty Screen and glass add-ons

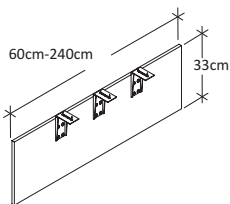
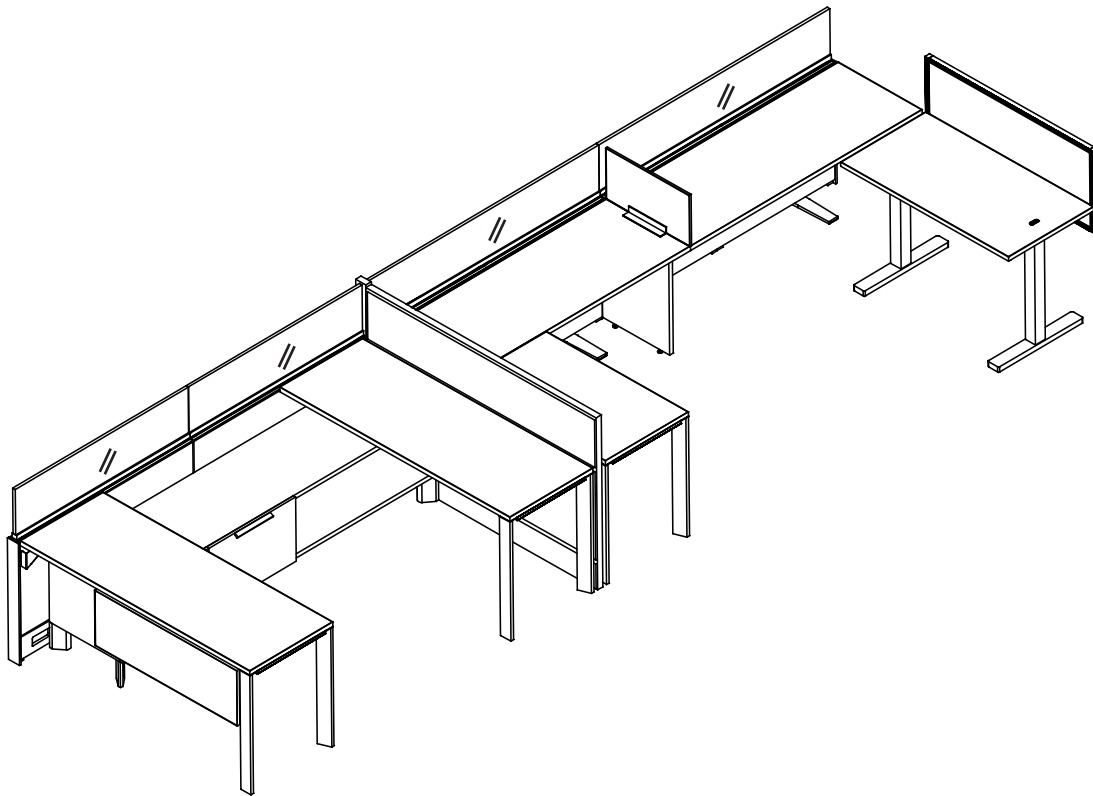

Modesty Screen (MUNSM)

- Mounts 2.5cm below worksurfaces to provide visual privacy, and is an off-module casual fit
- Must be mounted at least 7cm in from the back edge of a worksurface (actual width is 2.5cm less than the nominal width)
- Available in Source Laminate and Foundation Laminate.

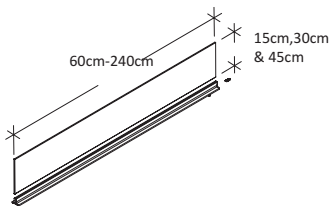

Panel Wall Add-On Screen –Glass (MUNSPG)

- Provides a light frameless alternative to a window or solid fascia at the top of a panel
- Available in glass
- Can be mounted on- or off-module, or span two panel walls but cannot span a 180° spacer or 90° connection
- Replaces the top trim of the same width on the panel wall

screens

MUNSDT

Desk Top Casual Screen

The Desk Top Screen is freestanding, providing space division and territorial desktop privacy.

WHAT'S INCLUDED

1 desk top screen with base support.

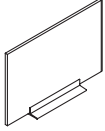

PRODUCT OPTIONS

Height	Width	Screen Finish	Base Finish
030	06	Source Laminate	AC Clear Foundation Foundation Mica

154

SAMPLE ORDER CODE

MUNSDT 030	06	R1	AC
------------	----	----	----

DIMENSIONS CM

H	W
03 / 30	06 / 60

PRICING

Source Laminate
135

The Desk Top Mounted Screen is mounted to a worksurface to provide privacy and space division.

WHAT'S INCLUDED

1 screen, attachment hardware.

NOTES

Edge trim will be finished to match the screen when Source Laminate, Standard Glass, Frost is a 10mm etched tempered glass.

MUNSBWS
Desk Top Mounted Screen

Can only be used on District worksurfaces.

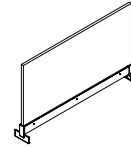

PRODUCT OPTIONS

Height	Width	Screen Finish	Base Finish
030	05, 06, 07, 08	Source Laminate Frosted Etched Tempered Glass	Foundation Mica

SAMPLE ORDER CODE

MUNSBWS 030	06	R1	Q
-------------	----	----	---

DIMENSIONS
CM

PRICING

H	W	Source Laminate	Frosted Etched Tempered Glass
03 / 30	05 / 50	182	437
03 / 30	06 / 60	193	452
03 / 30	07 / 70	219	512
03 / 30	08 / 80	245	571

screens

MUNSM Modesty Screen

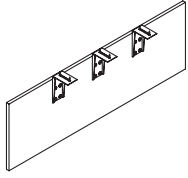

The Modesty Screen provides visual privacy below worksurface.

WHAT'S INCLUDED
1 screen, attachment brackets.

NOTES
Edge trim will be finished to match the modesty screen.

PRODUCT OPTIONS

Height	Width	Screen Finish	Bracket Finish
033	06, 08, 09, 10, 12, 14, 15, 16, 18, 20, 24	Source Laminate Foundation Laminate	Foundation Mica

156

SAMPLE ORDER CODE

MUNSM 33	06	R1	Q
----------	----	----	---

DIMENSIONS CM

DIMENSIONS CM		PRICING	
H	W	Source Laminate	Foundation Laminate
033 / 33	06 / 60	162	203
033 / 33	08 / 80	170	212
033 / 33	09 / 90	177	221
033 / 33	10 / 100	184	230
033 / 33	12 / 120	227	284
033 / 33	14 / 140	235	294
033 / 33	15 / 150	242	303
033 / 33	16 / 160	250	313
033 / 33	18 / 180	257	321
033 / 33	20 / 200	264	330
033 / 33	24 / 240	285	356

The Panel Wall Add-On Screen – Glass is added on top of Panel Walls to provide a lighter, frameless alternative to windows.

WHAT'S INCLUDED

1 add-on screen, support frame, attachment hardware.

NOTES

Standard Glass, Clear is a tempered glass finish.

Frost Glass is etched tempered glass

MUNSPG
Panel Wall Add-On Screen – Glass

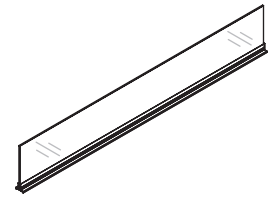

PRODUCT OPTIONS

Height	Width	Screen Finish	Support Frame Finish
015, 030, 045	06, 08, 09, 10, 12, 14, 15, 16, 18, 20, 24	5 Clear Standard Glass 6 Frost	Foundation Mica (AC) Clear Anodized

SAMPLE ORDER CODE

MUNSPG 33	06	6	AC
-----------	----	---	----

DIMENSIONS
CM

PRICING

H	W	Standard Clear	Glass Frost
015 / 15	06 / 60	220	334
015 / 15	08 / 80	254	374
015 / 15	09 / 90	300	426
015 / 15	10 / 100	341	476
015 / 15	12 / 120	381	522
015 / 15	14 / 140	420	569
015 / 15	15 / 150	461	616
015 / 15	16 / 160	501	666
015 / 15	18 / 180	540	710
015 / 15	20 / 200	580	758
015 / 15	24 / 240	701	899
030 / 30	06 / 60	239	363
030 / 30	08 / 80	283	417
030 / 30	09 / 90	326	470
030 / 30	10 / 100	369	524
030 / 30	12 / 120	411	575
030 / 30	14 / 140	454	631
030 / 30	15 / 150	498	682
030 / 30	16 / 160	541	737
030 / 30	18 / 180	584	790
030 / 30	20 / 200	628	844
030 / 30	24 / 240	757	1003

DIMENSIONS
CM

PRICING

H	W	Standard Clear	Glass Frost
045 / 45	06 / 60	249	379
045 / 45	08 / 80	293	435
045 / 45	09 / 90	338	490
045 / 45	10 / 100	382	548
045 / 45	12 / 120	426	603
045 / 45	14 / 140	473	661
045 / 45	15 / 150	516	715
045 / 45	16 / 160	561	772
045 / 45	18 / 180	604	826
045 / 45	20 / 200	696	886
045 / 45	24 / 240	786	1052

connections & trims

connections & trims

PRODUCT MAP / TABLE OF CONTENTS	159
TRIMS & CONNECTORS OVERVIEW	162
TRIM BASICS	163
CONNECTOR BASICS	164
THIN PANEL CONNECTOR OVERVIEW	166
THIN TO THICK CONNECTOR BASICS	169
THIN TO THIN CONNECTOR BASICS	170
PRODUCT LISTING	172

product map

MUNTT Top Trim

Page 172
Width: 60cm- 240cm

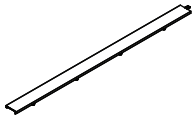

MUNTTTP Top Trim –
Power Pole Access

Page 173
Width: 60cm -240cm

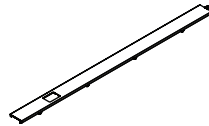

MUNTE End Trim

Page 174
Height: 75cm -165cm



MUATE End Trim for Freestanding
District

Page 175
Height: 75cm,105cm,120cm,135cm



MUNTM Intermediate End Trim

Page 176
Height: 15cm,30cm,45cm,60cm,75cm,90cm

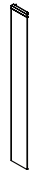

MUNPCR2 Two-Way 90°

Page 177
Height:75cm,105cm,120cm,135cm,150cm,165cm



MUNPCR3 Three-Way 90°

Page 178
Height: 75cm,105cm,120cm,135cm



MUNPCR4 Four-Way 90°

Page 179
Height: 75cm,105cm,120cm,135cm,150cm,165cm



MUNPCCR Two-Way 180° Spacer

Page 180
Height: 75cm,105cm,120cm,135cm,150cm,165cm



MUNIC2 Two-Way Intermediate 90°

Page 181
Height: 35cm,45cm,60cm,75cm,90cm



MUNIC3 Three-Way Intermediate
90°

Page 182
Height: 30cm,45cm,60cm,75cm,90cm

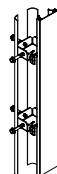

MUNIC4 Four-Way Intermediate
90°

Page 183
Height: 30cm,45cm,60cm,75cm,90cm

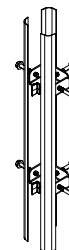

MUNICC Two-Way Intermediate
180°

Page 184
Height: 30cm, 45cm, 60cm, 75cm, 90cm

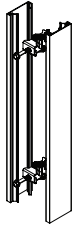

MUNTC Transition Cover

Page 185
Height: 105cm, 120cm, 135cm, 150cm, 165cm



MUNPCW Wall Start

Page 186
Height: 75cm, 105cm, 120cm, 135cm, 150cm, 165cm



MUCCT1 One District with Thin
Panel Connector

Page 187
Height: 105Ccm, 120cm, 135cm, 150cm

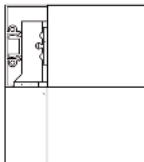

MUCCT2 Four-Way Two District
with Two Thin Panel
Connector

Page 188
Height: 105Ccm, 120cm, 135cm, 150cm

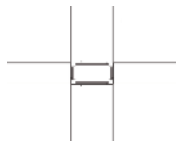

MUCCT3D Three Way District
with Thin Panel
Connector

Page 189
Height: 105Ccm, 120cm, 135cm, 150cm



MUCCT90 Two Way 90 Degree

Page 190
Height: 105Ccm, 120cm, 135cm, 150cm

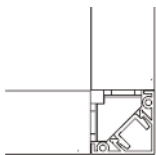

MUCCT3 Three Way
180 Degree

Page 191
Height: 105Ccm, 120cm, 135cm, 150cm

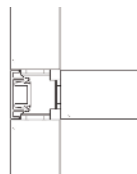

MUCCT4 Four Way 90 Degree

Page 192
Height: 105Ccm, 120cm, 135cm, 150cm

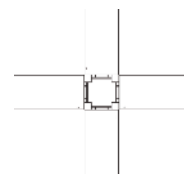

MUET District
Thin Panel End Trim

Page 193
Height: 105Ccm, 120cm, 135cm, 150cm



MUDT Intermediate Trim

Page 194
Height: 105Ccm, 120cm, 135cm, 150cm



trims & connectors overview

Trims and connectors are required to finish the tops, ends and corners of District Panel Walls and Add-On Windows

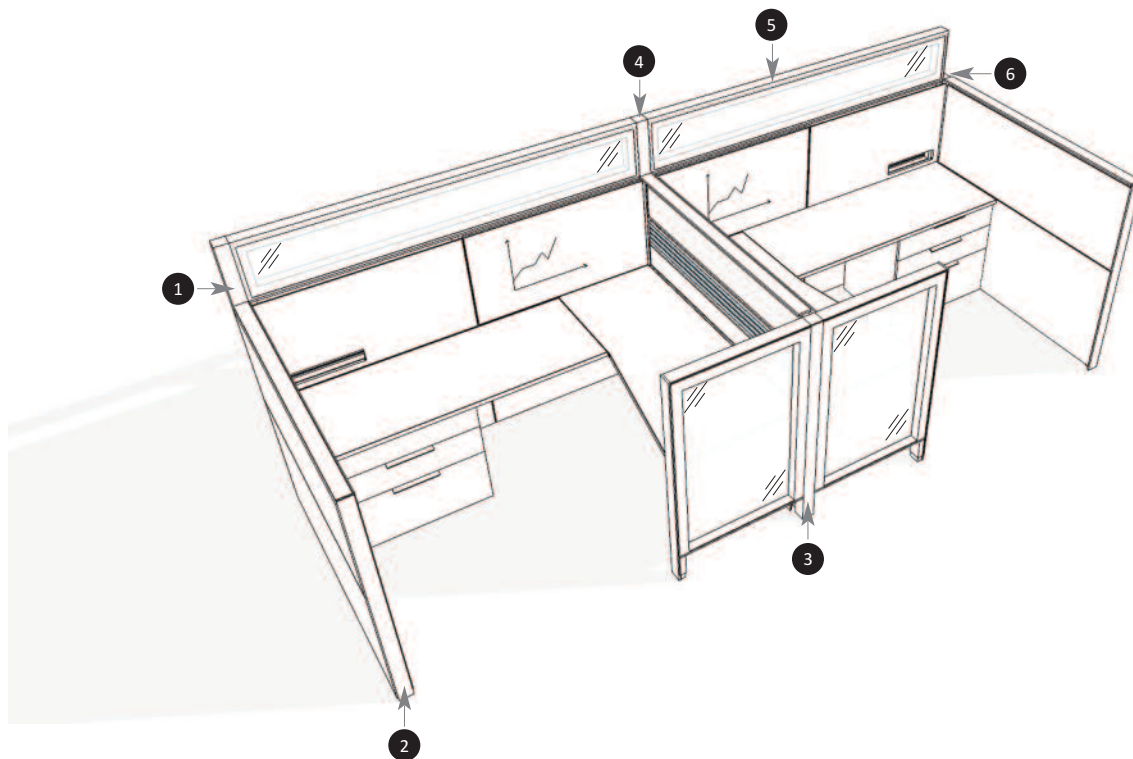

162

- 1 Corner connectors include brackets, trims and corner caps.
- 2 All trims are bolted to the panel wall for positive engagement and alignment.
- 3 Corner connectors are specified to match the panel type that they are being used with (ex. Flush/Convertible-to- Flush/Convertible, Elevated-to-Elevated, or Flush/Convertible-to-Elevated)
- 4 All panel wall connections are on-module
- 5 Top trims are available up to 240cm wide to span across both sections of panels over 150cm wide
- 6 Connectors are available for two-, three- and four-way connections as well as 180° connections

The following outlines the features of each of the trims available in District.

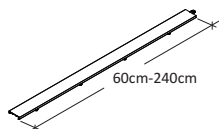
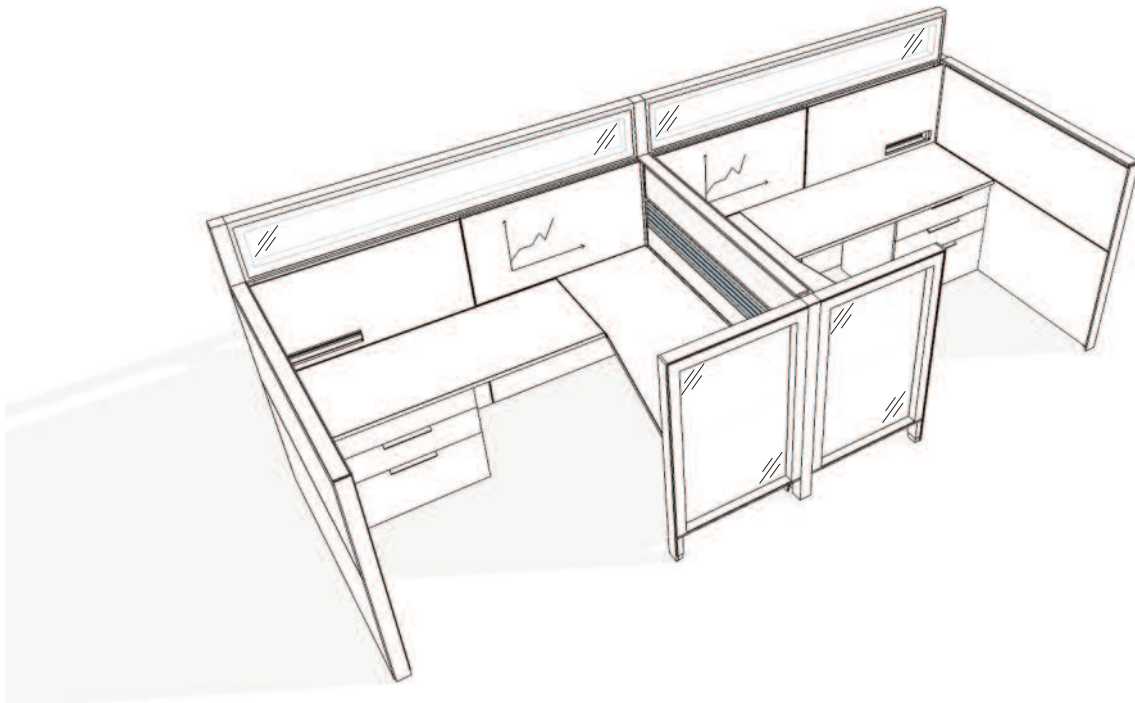

- Top Trim (MUNTT)**
- A full width trim on the top of a panel wall or add-on window
 - 1.1cm thick

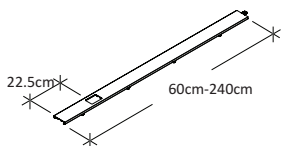

- Top Trim – Power Pole Access (MUNTP)**
- Same as the Top Trim except with a cut out to allow a Power Pole to be installed off-module 22.5cm from a panel end
 - Non-handed

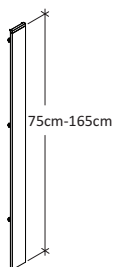

- End Trim (MUNTE)**
- A full-height trim that conceals the end of a panel wall
 - Uses the same heights as those used for both Flush and Elevated Panel Walls
 - Required to cover the full height of a panel wall, including add-on window and full-height window, if applicable
 - Can be used on panel walls with or without Accessory Beam



- End Trim for Freestanding District (MUATE)**
- Used in freestanding applications to accommodate the support foot gaps
 - Available in Mica & Foundation finishes
 - Can be used on panel walls with or without Accessory Beam

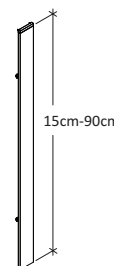

- Intermediate End Trim (MUNTM)**
- Conceals an exposed portion of a panel wall, add-on window or full-height window in a change-of-height location

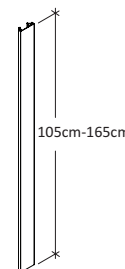

- Transition Cover (MUNTC)**
- Used to provide a seamless vertical trim cover when an intermediate panel connection occurs above a full panel connection

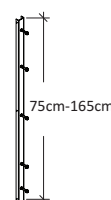

- Wall Start (MUNPCW)**
- Used to connect either elevated or standard Panel Walls (no corners) to reinforced drywall
 - Foot is specified separately for elevated Panel Walls at the wall start connector point

connector basics

The following outlines the features of each of the connectors available in District.

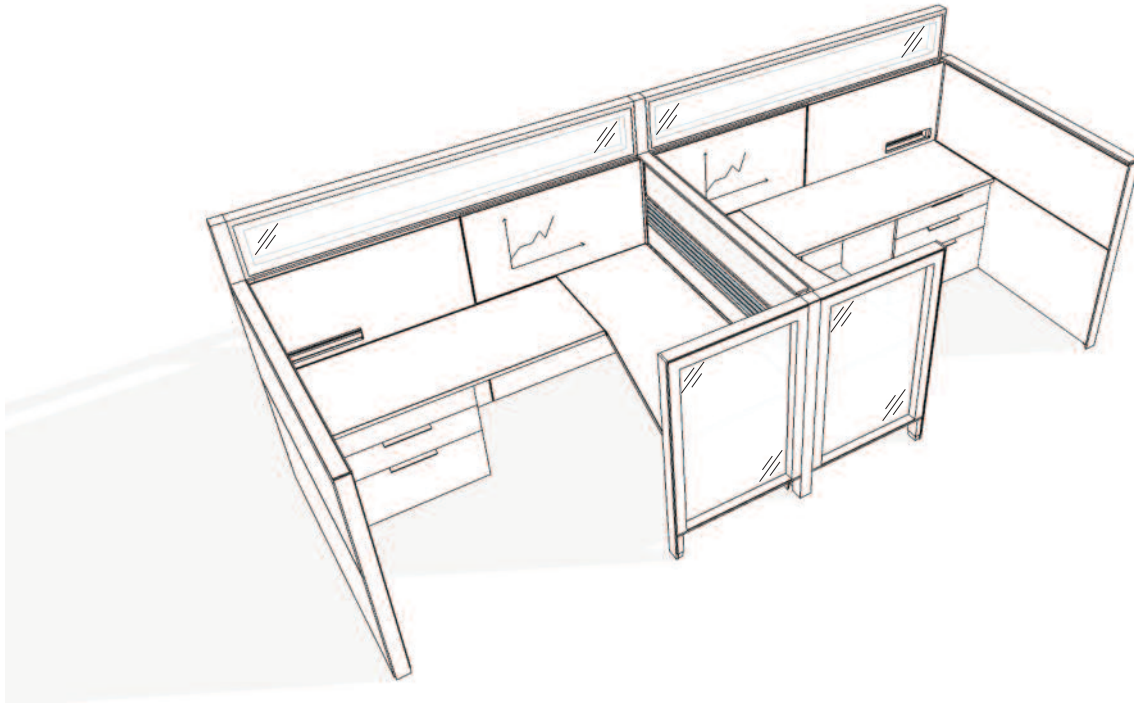

Two-Way 90° (MUNPCR2)

- Connection is used to connect two panel walls and windows at 90° in same panel height or varying panel height configurations
- For change of heights, the connector is specified for the lowest height panel
- Available with options for connecting Flush, Elevated or Convertible Panel Walls

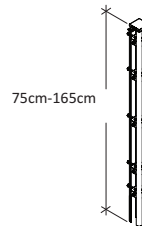

Four-Way 90° (MUNPCR4)

- Connection is used to connect four panel walls and full-height windows at 90° in same panel height or varying panel height configurations
- Used for change of heights, the connector is specified for the lowest height panel wall
- Available with options for connecting Flush, Elevated or Convertible Panel Walls

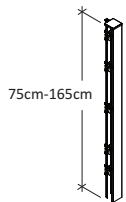

Three-Way 90° (MUNPCR3)

- Connection is used to connect three panel walls at 90° in same panel wall height or varying panel wall height configurations
- Used for change of heights, the connector is specified for the lowest height panel wall
- Available in two configurations:
 - (1) one vertical cover and top cap which completely finishes the connection when no Intermediate 180° Connector (MUNIC3) will be used above it
 - (0) no vertical cover or top cap is used for change-of-height connections when an Intermediate 180° Connector (MUNIC3) is used above it, a separate Transition Cover (MUNTC) must be ordered
- Available with options for connecting Flush, Elevated or Convertible Panel Walls

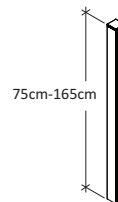

Two-Way 180° Spacer (MUNPCCR)

- Connection is used when a spacer is required between two panel walls, full-height windows or add-on windows joined at 180° to match either panel wall lengths or to provide a needed space for screens etc.
- Used for change of heights, the connector is specified for the lowest height panel wall
- Available with options for connecting Flush, Elevated or Convertible Panel Walls
- In most layouts no spacer is needed, panel walls are bolted together with no gap

connections & trims

connector basics (continued)

The following outlines the features of each of the connectors available in District.

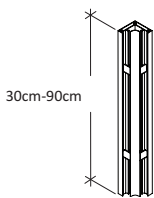
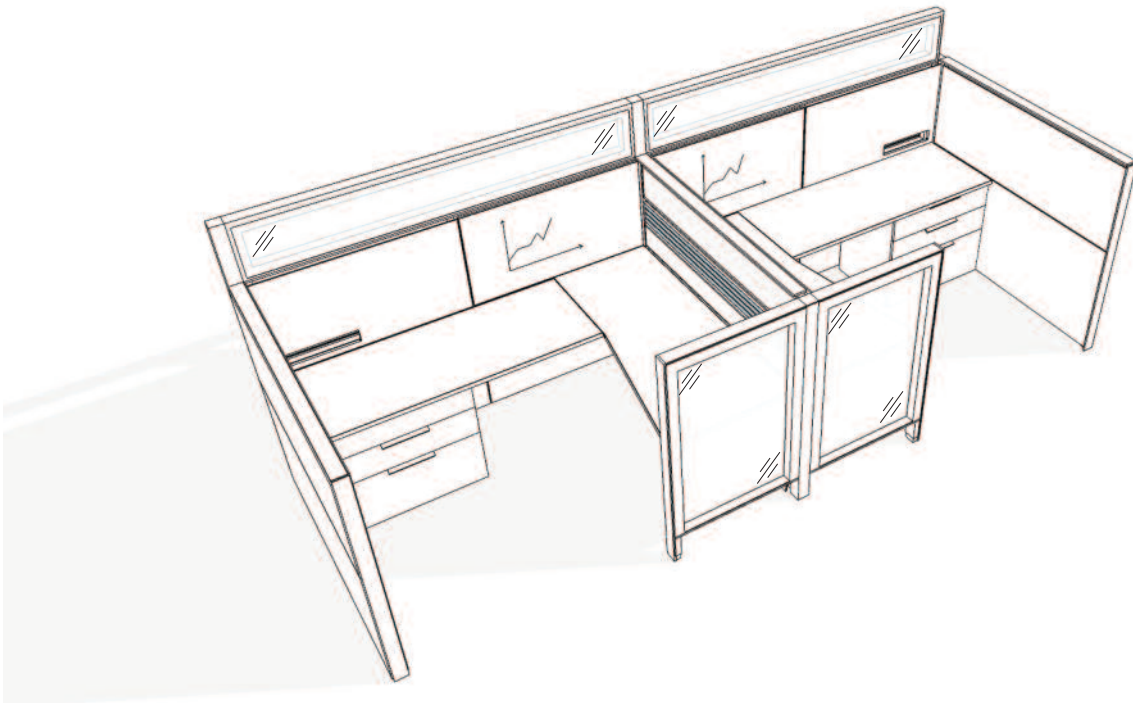

Two-Way Intermediate 90° (MUNIC2)

- Connection is used to fill the exposed ends of panel walls above a three-way or four-way connection in a change-of-height configuration

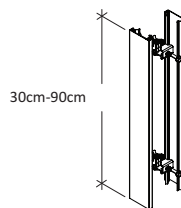

Two-Way Intermediate 180° (MUNICC)

- Connections is used to fill the exposed ends of panel walls or add-on windows above a 180° spacer in change-of-height configurations
- Available in two configurations;
 - (2) two vertical covers (completely finishes both sides with equal length trim covers)
 - (1) one vertical cover only (select when a two-way Intermediate 180° connection is above a three-way 90° connection a Transition Cover (MUNTC) is ordered separately to cover the open side)

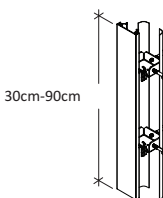

Three-Way Intermediate 90° (MUNIC3)

- Connection is used to fill the exposed ends of panel walls or add-on windows above a four-way connector in change of height configurations

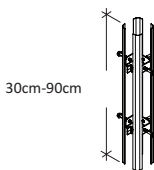

Four-Way Intermediate 90° (MUNIC4)

- Connection is used to fill the gap created when four add-on windows are added above an existing four-way connection

thin panel connector overview

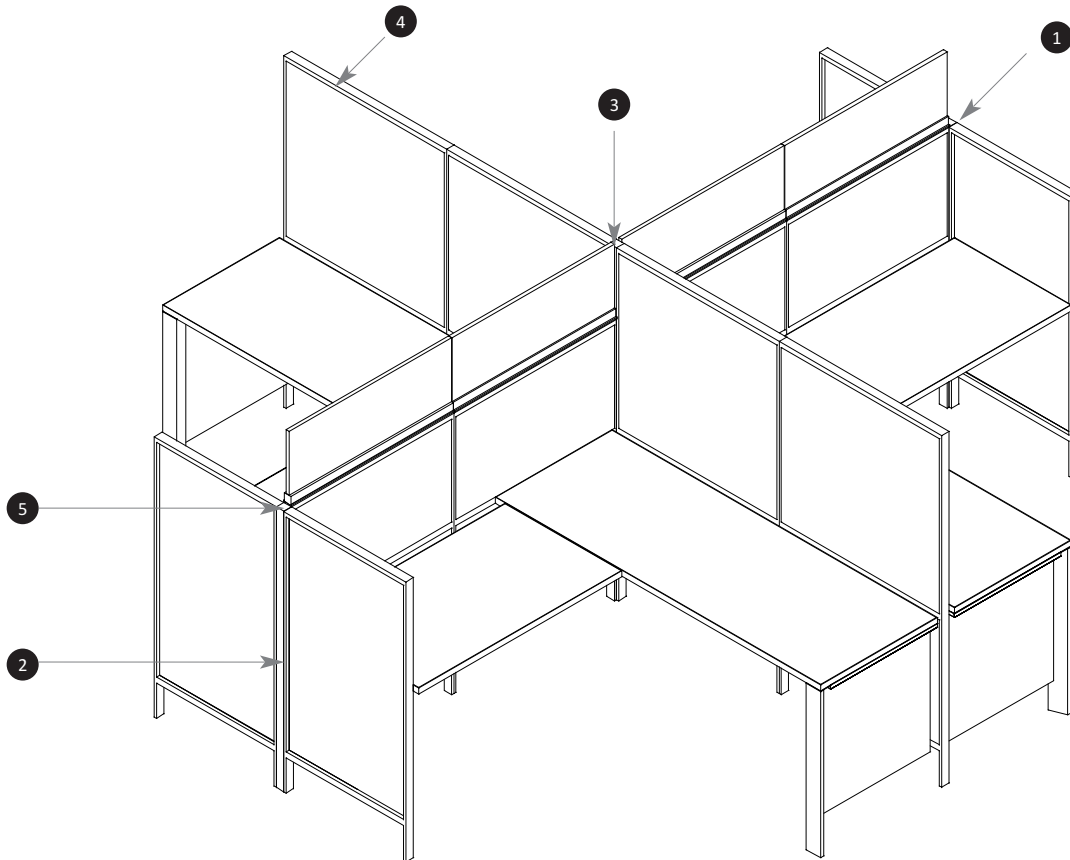

- 1 Corner connectors include brackets, trims and corner caps.
- 2 All trims are bolted to the panel wall for positive engagement and alignment.
- 3 All panel wall connections are on-module
- 4 Top trims are available up to 180cm wide to span across both sections of panels over 150cm wide
- 5 Connectors are available for two-, three- and four-way connections

thin panel connector overview (continued)

Connections Basics

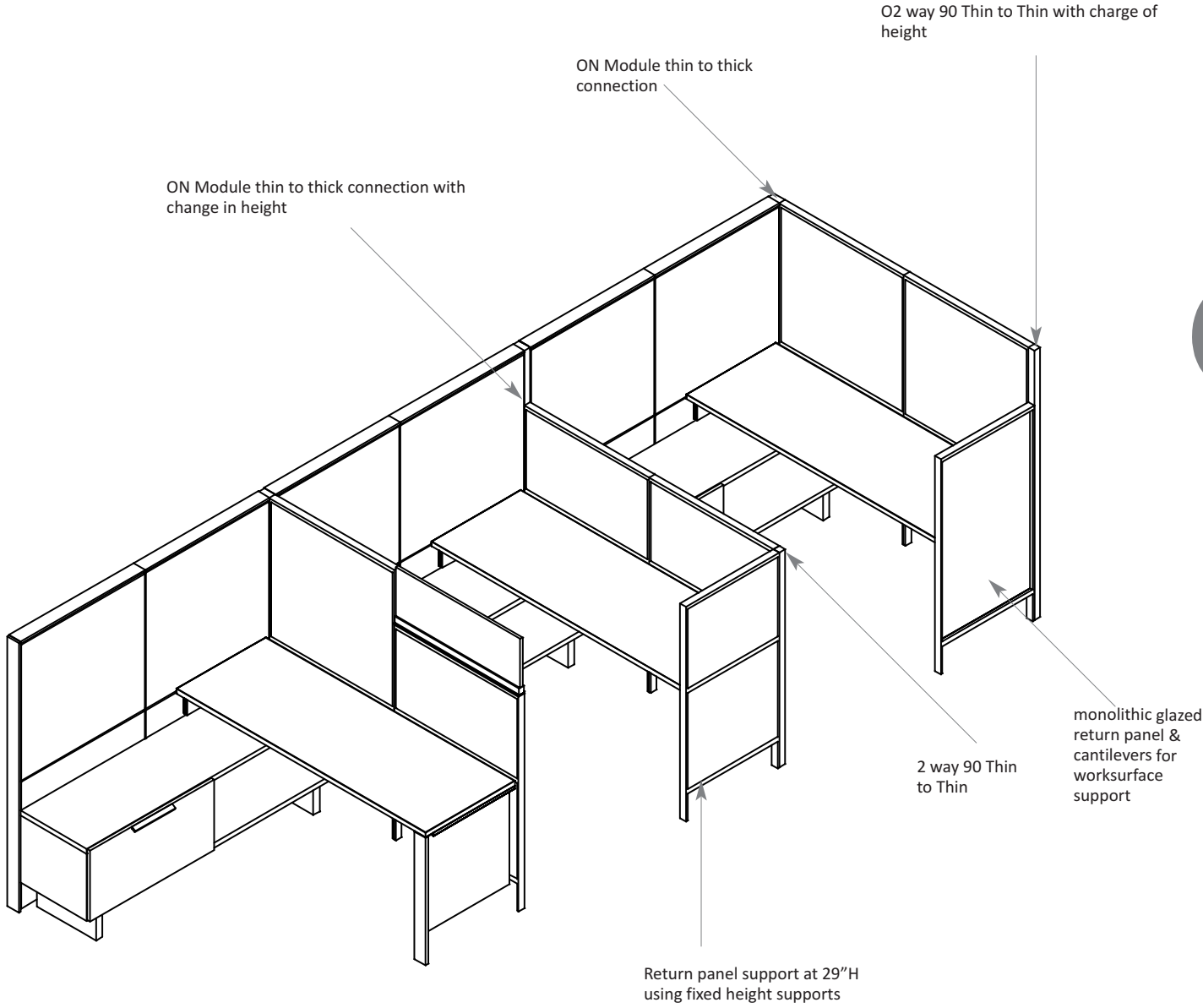

Note:
Thin Panels do not connect to District panels at 180°

thin panel connector overview (continued)

Thin to Thin Connection Basics

168

Thin Panels can be connected to each other ON
Module at the same OR varied height

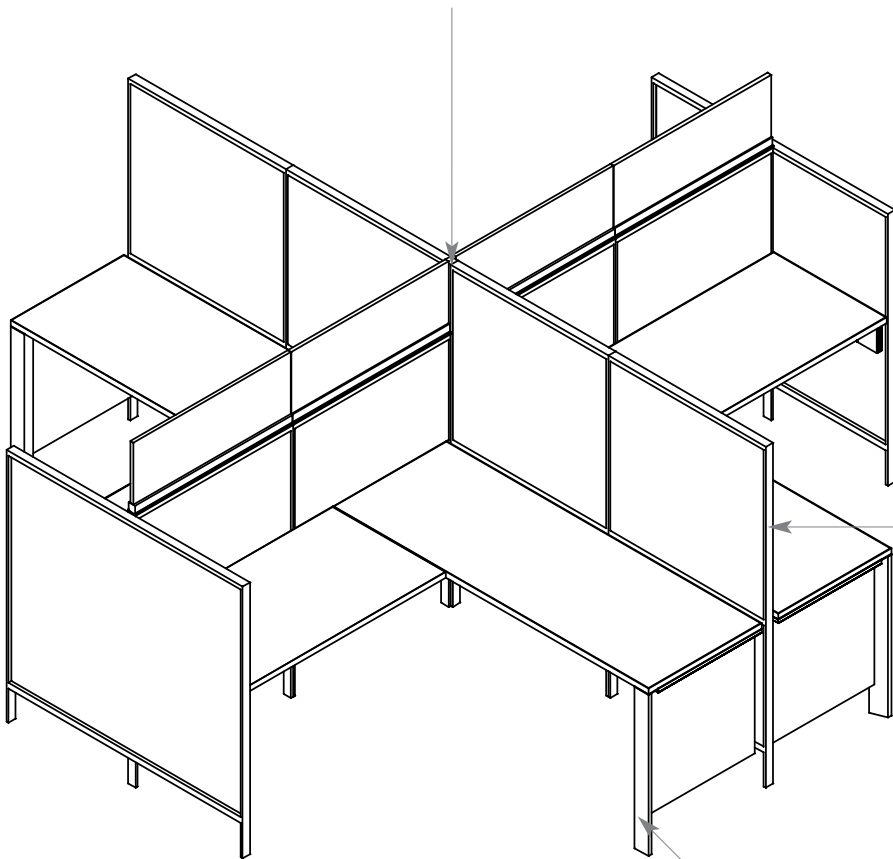

An End Trim is
required at each
end of run

Worksurfaces provide stability through end
gables

thin to thick connector basics

Trims and connections are required to finish the tops, ends and corners of District Panel Walls

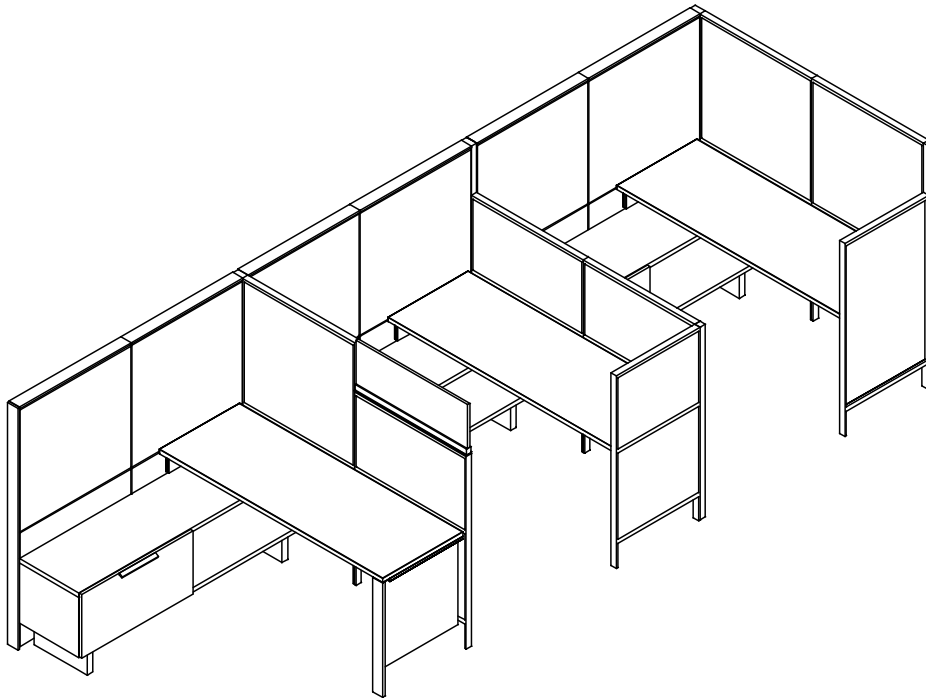

Thin to thick Two-Way 90° (MUCCT 1)

- Connection is used to connect thin panel to district panel walls and windows at 90° in same panel height
- For change of heights, the connector is specified for the lowest height panel

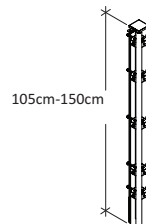

Thin to Thick Four-Way 90° (MUCCT2)

- Connection is used to connect two thin panel with two district panel walls and full-height windows at 90° in same panel height
- Used for change of heights, the connector is specified for the lowest height panel wall

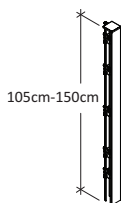

Thin to thick Three-Way 90° (MUCCT 3D)

- Connection is used to connect thin panel with district panel walls at 90° in same panel wall height
- Available in two configurations:
 - (1) Two thin panel with district panel wall
 - (2) One thin panel with two district panel wall

thin to thin connector basics

Trim and connections are required to finish the tops, ends and corners of District Thin Panels

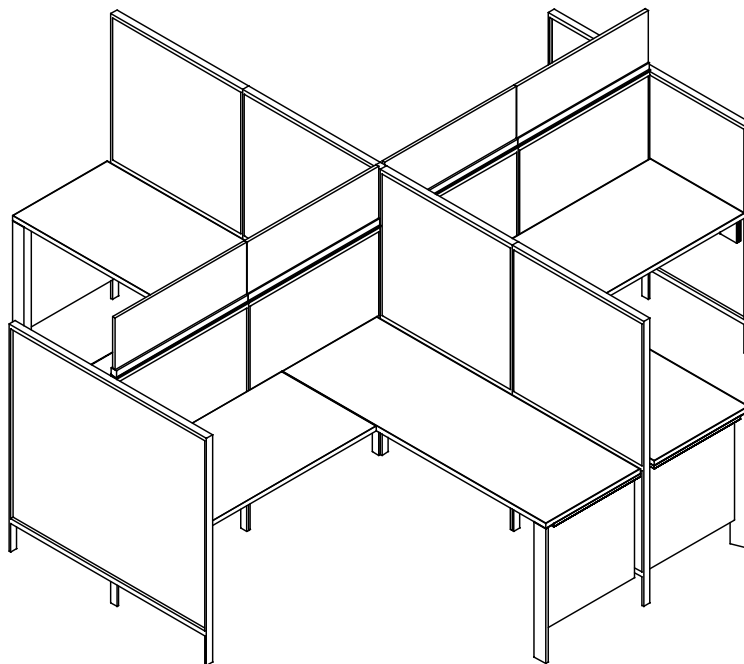

- Thin to thin Two-Way 90° (MUCCT 90)**
- Connection is used to connect two thin panel at 90° in same panel height
 - For change of heights, the connector is specified for the lowest height panel

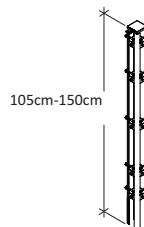

- Thin to thin Four-Way 90° (MUCCT 4)**
- Connection is used to connect four thin panel at 90° in same panel height
 - Used for change of heights, the connector is specified for the lowest height panel wall

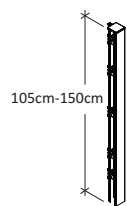

- Thin to thin Three-Way 90° (MUCCT 3)**
- Connection is used to connect three thin panel at 90° in same panel wall height



- Intermediate End Trim (MUDT)**
- Conceals an exposed portion of a thin panel in a change-of- height location

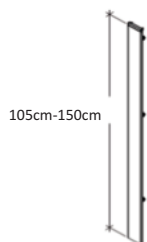

- End Trim (MUET)**
- A full-height trim that conceals the end of a thin panel
 - Uses the same heights as those used for both Flush and Elevated Panel Walls

connections & trims

MUNTT Top Trim

The Top Trim finishes the top of a panel wall, full-height window or add-on window.

WHAT'S INCLUDED
Top trim, attachment hardware, gasket.

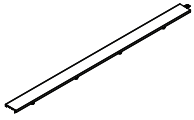

PRODUCT OPTIONS

Width	Finish
06, 08, 09, 10, 12, 14, 15, 16, 18, 20, 24	Foundation Mica AC Anodized

172

SAMPLE ORDER CODE

MUNTT 06	Q
----------	---

DIMENSIONS CM

PRICING

W	
06 / 60	47
08 / 80	50
09 / 90	57
10 / 100	63
12 / 120	68
14 / 140	75
15 / 150	80
16 / 160	87
18 / 180	93
20 / 200	99
24 / 240	115

M U N T T P

Top Trim – Power Pole Access

The Top Trim – Power Pole Access finishes the top of a panel wall with a cut out for off-module power pole applications.

WHAT'S INCLUDED

Top trim, attachment hardware, gasket.

NOTES

The cut out is located 22.5cm from one end of the top trim.

Trim is non-handed.

Required for off-module Power Pole (MUNQEP) applications.

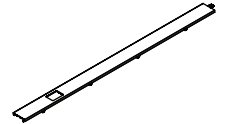

PRODUCT OPTIONS

Width	Finish
06, 08, 09, 10, 12, 14, 15, 16, 18, 20, 24	Foundation Mica AC Anodized

173

SAMPLE ORDER CODE

MUNTTP 06	Q
-----------	---

DIMENSIONS
CM

PRICING

W	
06 / 60	89
08 / 80	92
09 / 90	99
10 / 100	106
12 / 120	112
14 / 140	118
15 / 150	122
16 / 160	129
18 / 180	136
20 / 200	143
24 / 240	157

connections & trims

MUNTE End Trim

The End Trim finishes the end of a panel wall, full-height window or add-on window combination.

WHAT'S INCLUDED
End trim, attachment hardware.



PRODUCT OPTIONS

Height	Finish
075, 105, 120, 135, 150, 165	Foundation Mica AC Anodized

174

SAMPLE ORDER CODE

MUNTE 120	Q
-----------	---

DIMENSIONS CM

PRICING

H	
075 / 75	59
105 / 105	73
120 / 120	86
135 / 135	91
150 / 150	95
165 / 165	100

The End Trim finishes the end of a panel wall.

WHAT'S INCLUDED
End trim, attachment hardware.

NOTES
End Trim is to only be applied to District Panel that is supported by the Free standing Foot (MUAFFN).

M U A T E
End Trim for Freestanding District



PRODUCT OPTIONS

Height	End Trim Finish
075, 105, 120, 135	Foundation Mica AC Anodized

175

SAMPLE ORDER CODE

MUATE 120	Q
-----------	---

DIMENSIONS

CM	PRICING
H	
075 / 75	59
105 / 105	73
120 / 120	86
135 / 135	102

connections & trims

MUNTM

Intermediate End Trim

The Intermediate End Trim finishes the end of a panel wall, full-height window or add-on window in a change of height location.

WHAT'S INCLUDED

Intermediate end trim, attachment hardware.



PRODUCT OPTIONS

Height	Finish
015, 030, 045, 060, 075, 090	Foundation Mica AC Anodized

176

SAMPLE ORDER CODE

MUNTM 060	Q
-----------	---

DIMENSIONS CM

PRICING

H	
015 / 15	35
030 / 30	38
045 / 060	40
060 / 60	51
075 / 75	56
090 / 90	66

The Two-Way 90° connector provides a finished connection for two panel walls and windows at 90° in same-height or varying-height configurations.

MUNPCR2

Two-Way 90°

WHAT'S INCLUDED

Corner trim, corner brackets, attachment hardware, top cap, elevated panel wall foot (as specified).

NOTES

Panel wall type indicates the panel wall mix at the 90° connection.

Internal (non-visible) brackets are painted in Ebony.



PRODUCT OPTIONS

Panel Type	Height	Finish
FF 1 Flush Panel/Flush Full-Height Window /Convertible Panel and 1 Flush Panel /Flush Full-Height Window/Convertible Panel Wall	075, 105, 120, 135, 150, 165	Foundation
EE 1 Elevated Panel/Elevated Full-Height Window and 1 Elevated Panel/Elevated Full-Height Window		Mica
EA 1 Flush Panel/Flush Full-Height Window /Convertible Panel Wall and 1 Elevated Panel /Elevated Full-Height Window		AC Anodized

177

SAMPLE ORDER CODE

MUNPCR2 EE	120	Q
------------	-----	---

**DIMENSIONS
CM**

PRICING

H	1 Flush Panel & 1 Elevated Panel	2 Elevated Panels	2 Flush Panels
075 / 75	185	185	123
105 / 105	220	220	159
120 / 120	249	249	187
135 / 135	261	261	199
150 / 150	272	272	211
165 / 165	283	283	223

connections & trims

MUNPCR3 Three-Way 90°



The Three-Way 90° connector provides a finished connection for three panel walls and windows at 90° in same-height or varying-height configurations.

WHAT'S INCLUDED

1 trim, corner brackets, attachment hardware, top cap, elevated panel wall foot (as specified).

WHAT'S EXCLUDED

Panel wall type indicates the panel wall mix at the 90° connection.

When Trim option (0) is selected, a Transition Cover (MUNTC) must be ordered separately to cover the open side. Can be found on page xx

PRODUCT OPTIONS

Panel Type		Height	Trim	Finish
FF	Flush Panels/Flush Full-Height Windows/Convertible Panel Wall	075, 105, 120, 135, 150, 165	0 Excludes Vertical Cover (select when a two-way intermediate 180° connection is above a three-way 90° connection)	Foundation
EE	Elevated Panels/Elevated Full-Height Windows			Mica
EA	1 Elevated Panel/Elevated Full-Height Window and 2 Flush Panels/Flush Full-Height Windows/Convertible Panel Wall		1 1 Vertical Cover (completely finishes connection)	AC Anodized
EB	2 Elevated Panels/Elevated Full-Height Windows at 90° and 1 Panel/Flush Full-Height Window/Convertible Panel Wall			
EC	2 Elevated Panels/Elevated Full-Height Windows at 180° and 1 Flush Panel/Flush Full-Height Window/Convertible Panel Wall			

SAMPLE ORDER CODE

MUNPCR3 EE	120	1	Q
------------	-----	---	---

DIMENSIONS CM

PRICING

H	NO TRIM COVER (0)				
	Panel Type (EA)	Panel Type (EB)	Panel Type (EC)	Panel Type (EE)	Panel Type (FF)
075 / 75	121	121	121	121	60
105 / 105	136	136	136	136	75
120 / 120	150	150	150	150	89
135 / 135	156	156	156	156	95
150 / 150	161	161	161	161	100
165 / 165	167	167	167	167	106
075 / 75	180	180	180	121	120
105 / 105	213	213	213	136	152
120 / 120	242	242	242	150	180
135 / 135	253	253	253	253	191
150 / 150	264	264	264	264	202
165 / 165	274	274	274	167	213

The Four-Way 90° connector provides a finished connection for four panel walls and windows at 90° in same-height or varying-height configurations.

WHAT'S INCLUDED

Corner brackets, attachment hardware, top cap, gasket, elevated panel wall F=foot (as specified).

NOTES

Panel wall type indicates the panel wall mix at the 90° connection.

MUNPCR4 Four-Way 90°



PRODUCT OPTIONS

Panel Type		Height	Finish
FF	4 Flush Panels/Flush Full-Height Windows/Convertible Panel Wall	075, 105, 120, 135, 150, 165	Foundation Mica AC Anodized
EE	4 Elevated Panels/Elevated Full-Height Windows		
EA	1 Elevated Panel/Elevated Full-Height Window and 3 Flush Panels/Flush Full-Height Windows/Convertible Panel Wall		
EB	2 Elevated Panels/Elevated Full-Height Windows at 90° and 2 Flush Panels/Flush Full-Height Windows//Convertible Panel Wall at 90°		
EC	2 Elevated Panels/Elevated Full-Height Windows at 180° and 2 Flush Panels/Flush Full-Height Windows/Convertible Panel Wall at 180°		
ED	3 Elevated Panels/Elevated Full-Height Windows and 1 Flush Panel/Flush Full-Height Window		

179

SAMPLE ORDER CODE

MUNPCR4 EE	120	Q
------------	-----	---

DIMENSIONS

CM

PRICING

H	Panel Type (EA)	Panel Type (EB)	Panel Type (EC)	Panel Type (ED)	Panel Type (EE)	Panel Type (FF)
075 / 75	147	147	147	147	147	84
105 / 105	167	167	167	167	167	104
120 / 120	186	186	186	186	186	122
135 / 135	192	192	192	192	192	128
150 / 150	198	198	198	198	198	135
165 / 165	204	204	204	204	204	141

connections & trims

MUNPCCR

Two-Way 180° Spacer



The Two-Way 180° Spacer connector provides finished spacer connection between two panel walls and windows joined at 180° equal to the thickness of one panel wall.

WHAT'S INCLUDED

2 trims, brackets, attachment hardware, top cap, elevated panel wall foot (as specified).

NOTES

Panel wall type indicates the panel wall mix at the 180° connection.

PRODUCT OPTIONS

Panel Type		Height	Finish
FF	Flush Panels/Flush Full-Height Windows /Convertible Panel Wall	075, 105, 120, 135, 150, 165	Foundation
EE	Elevated Panels/Elevated Full-Height Windows		Mica
EA	1 Flush Panel/Flush Full-Height Window /Convertible Panel Wall and 1 Elevated Panel/Elevated Full-Height Window		AC Anodized

180

SAMPLE ORDER CODE

MUNPCCR EE	120	AC
------------	-----	----

DIMENSIONS

H	PRICING		
	Panel Type (EA)	Panel Type (EE)	Panel Type (FF)
075 / 75	185	185	121
105 / 105	215	215	151
120 / 120	243	243	179
135 / 135	253	253	190
150 / 150	264	264	210
165 / 165	274	274	212

The Two-Way Intermediate 90° connector provides finished connection to the exposed ends of panel walls and windows or add-on windows above a three- or four-way connector in change-of-height configuration.

WHAT'S INCLUDED

Corner trim, corner brackets, attachment hardware.

WHAT'S EXCLUDED

Top cap.

MUNIC2

Two-Way Intermediate 90°



PRODUCT OPTIONS

Height	Finish
030, 045, 060, 075, 090	Foundation Mica AC Anodized

SAMPLE ORDER CODE

MUNIC2 060	AC
------------	----

DIMENSIONS

DIMENSIONS CM	PRICING
H	
030 / 30	72
045 / 45	76
060 / 60	101
075 / 75	109
090 / 90	129

MUNIC3

Three-Way Intermediate 90°

The Three-Way Intermediate 90° connector provides finished connection to the exposed ends of panel walls and windows above a four-way connector in change-of-height configuration.

WHAT'S INCLUDED

Trim, corner brackets, attachment hardware.

WHAT'S EXCLUDED

Top cap.



PRODUCT OPTIONS

Height	Finish
030, 045, 060, 075, 090	Foundation Mica AC Anodized

182

SAMPLE ORDER CODE

MUNIC3 060	Q
------------	---

DIMENSIONS
CM

PRICING

H	
030 / 30	76
045 / 45	78
060 / 60	104
070 / 70	108
090 / 90	122

The Four-Way Intermediate 90° connector provides intermediate four-way connection when add-on windows are added above an existing four-way connection.

WHAT'S INCLUDED

Corner brackets, attachment hardware.

WHAT'S EXCLUDED

Top cap.

NOTES

Finished in Ebony.

MUNIC4 Four-Way Intermediate 90°

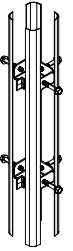

PRODUCT OPTIONS

Height

030, 045, 060, 075, 090

SAMPLE ORDER CODE

MUNIC4 060

DIMENSIONS
CM

PRICING

H	
030 / 30	57
045 / 45	58
060 / 60	78
075 / 75	80
090 / 90	81

MUNICC

Two-Way Intermediate 180°

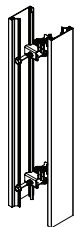

The Two-Way Intermediate 180° connector provides intermediate two-way spacer connection.

WHAT'S INCLUDED

2 trims, brackets, attachment hardware.

WHAT'S EXCLUDED

Top cap.

NOTES

When Trim option 1 is selected, a Transition Cover (MUNTC) must be ordered separately to cover the open side. Can be found on page 185

PRODUCT OPTIONS

Height	Trim	Finish
030, 045, 060, 075, 090	1 1 Vertical Cover (select when a two-way intermediate 180° connection is above a three-way 90° connection) 2 2 Vertical Covers (completely finishes both sides with equal length trim covers)	Foundation Mica AC Anodized

SAMPLE ORDER CODE

MUNICC 060	1	AC
------------	---	----

**DIMENSIONS
CM**

PRICING

H	1 Vertical Cover	2 Vesical Covers
030 / 30	47	70
045 / 45	48	72
060 / 60	62	95
075 / 75	65	101
090 / 90	76	117

The Transition Cover provides a seamless vertical trim cover when a two-way intermediate 180° panel wall connection occurs above a three-way connection.

WHAT'S INCLUDED

Transition cover, attachment hardware.

WHAT'S EXCLUDED

Top cap.

NOTES

Panel Wall Type indicates the panel wall mix at the 90° connection.

MUNTC Transition Cover



PRODUCT OPTIONS

Panel Type	Height	Finish
FF 3 Flush Panels	105, 120, 135, 150, 165	Foundation
EE 3 Elevated Panels		Mica
EA 2 Flush Panels and 1 Elevated Panel		AC Anodized
EB 1 Flush Panel and 2 Elevated Panels at 90°		
EC 1 Flush Panel and 2 Elevated Panels at 180°		

185

SAMPLE ORDER CODE

MUNTC EE	120	Q
----------	-----	---

DIMENSIONS

CM

PRICING

H	Panel Type (EA)	Panel Type (EB)	Panel Type (EC)	Panel Type (EE)	Panel Type (FF)
105 / 105	79	79	79	79	79
120 / 120	91	91	91	91	91
135 / 135	97	97	97	97	97
150 / 150	103	103	103	103	103
165 / 165	108	108	108	108	108

MUNPCW

Wall Start

The Wall Start connects panel walls to reinforced drywall.

WHAT'S INCLUDED

Wall start, connecting hardware.

NOTES

Finished in Ebony.



PRODUCT OPTIONS

Height

075, 105, 120, 135, 150, 165

186

SAMPLE ORDER CODE

MUNPCW 120

DIMENSIONS

DIMENSIONS CM	PRICING
H	
075 / 75	105
105 / 105	126
120 / 120	171
135 / 135	173
150 / 150	176
165 / 165	178

The Two-Way 90 deg connector provides a finished connection for 1 District Panel and Thin Panel at 90 Deg in same height

WHAT'S INCLUDED

Corner trim, Corner bracket, Attachment bracket, Top Cap, Elevated press Wall foot (as specified)

NOTES

Internal (Non-Visible) Brackets are painted in Ebony

MUCCT1 One District with Thin Panel Connector

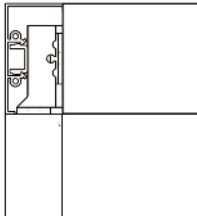

PRODUCT OPTIONS

Height	Orientation	Finish
105, 120, 135, 150	(L) Left (R) Right	Foundation Mica

187

SAMPLE ORDER CODE

MUCCT1 120	L	Q
------------	---	---

DIMENSIONS

CM	PRICING	
	Foundation	Mica
H		
105 / 104	138	142
120 / 119	143	148
135 / 134	149	158
150 / 149	159	168

connections & trims

MUCCT2

Four-Way Two District with Two Thin Panel Connector

The Four Way 90 Deg connector provides a Finished connection for 2 District with 2 Thin Panel at 90 deg in same height

WHAT'S INCLUDED

Corner brackets, attachment hardware, top cap, gasket, elevated panel wall F=foot (as specified).

NOTES

Panel wall type indicates the panel wall mix at the 90° connection.

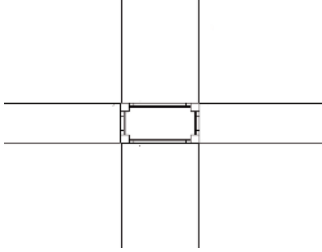

PRODUCT OPTIONS

Height	Finish
105, 120, 135, 150	Foundation Mica

SAMPLE ORDER CODE

MUCCT2 120	Q
------------	---

DIMENSIONS CM

PRICING

H	Foundation	Mica
105 / 104	138	142
120 / 119	143	148
135 / 134	149	158
150 / 149	156	168

3 Way 90deg connection provides a Finished connection for 3 Thin Panel, 1 Thin Panel at 90deg connection at same height

M U C C T 3 D

Three Way District with Thin Panel Connector

WHAT'S INCLUDED

1 trim, corner brackets, attachment hardware, top cap, elevated panel wall foot (as specified).

NOTES

Panel Wall Type indicates the panel wall mix at the 90° connection.



Configuration 1

Configuration 2

PRODUCT OPTIONS

Configuration	Height	Finish
(1) 1 District & 2 Thin Panel	105, 120, 135, 150	Foundation
(2) 2 District & 1 Thin Panel		Mica

189

SAMPLE ORDER CODE

MUCCT3D 2	120	Q
-----------	-----	---

DIMENSIONS

CM

PRICING

H	Foundation	Mica
105 / 104	138	142
120 / 119	143	148
135 / 134	149	158
150 / 149	156	168

connections & trims

MUCCT90

Two Way 90 Degree

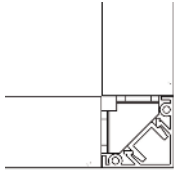

The 2 way 90deg connector provides a finished connection for 2 thin panel at 90deg in same height

WHAT'S INCLUDED

Corner trim, corner brackets, attachment hardware, top cap, elevated panel wall foot (as specified).

NOTES

Panel wall type indicates the panel wall mix at the 90° connection. Internal (non-visible) brackets are painted in Ebony.

PRODUCT OPTIONS

Height	Finish
105, 120, 135, 150	Foundation Mica

190

SAMPLE ORDER CODE

MUCCT90 120	Q
-------------	---

DIMENSIONS CM

PRICING

H	Foundation	Mica
105 / 104	79	84
120 / 119	88	94
135 / 134	97	107
150 / 149	107	117

The 3 way 90deg connector provides a finished connection for 3 thin panels at 90deg in same height

WHAT'S INCLUDED

1 trim, corner brackets, attachment hardware, top cap, elevated panel wall foot (as specified).

NOTES

Panel Wall Type indicates the panel wall mix at the 90° connection.

M U C C T 3

Three Way 180 Degree

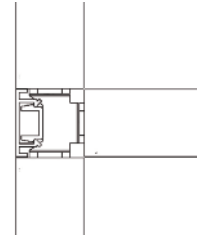

PRODUCT OPTIONS

Height	Finish
105, 120, 135, 150	Foundation Mica

191

SAMPLE ORDER CODE

MUCCT3 120	Q
------------	---

**DIMENSIONS
CM**

PRICING

H	Foundation	Mica
105 / 104	97	102
120 / 119	104	109
135 / 134	111	116
150 / 149	120	125

connections & trims

MUCCT4

Four Way 90 Degree

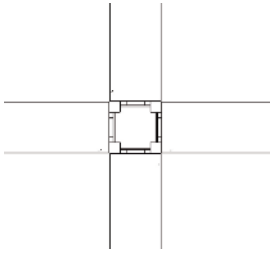

The 4 way 90deg connector provides a finished connection for Four thin panel at 90deg in same height

WHAT'S INCLUDED

Corner brackets, attachment hardware, top cap, gasket, elevated panel wall F=foot (as specified).

NOTES

Panel wall type indicates the panel wall mix at the 90° connection.

PRODUCT OPTIONS

Height	Finish
105, 120, 135, 150	Foundation Mica

SAMPLE ORDER CODE

MUCCT4 120	Q
------------	---

DIMENSIONS CM

PRICING

H	Foundation	Mica
105 / 104	104	109
120 / 119	111	116
135 / 134	118	124
150 / 149	125	132

The End Trim finished the end as thin panel
WHAT'S INCLUDED
 End Trim, Attachment hardware

M U E T
 District Thin Panel End Trim



PRODUCT OPTIONS

Height	Finish
105, 120, 135, 150	Foundation Mica

193

SAMPLE ORDER CODE

MUET 120	Q
----------	---

DIMENSIONS
 CM

PRICING

H	Foundation	Mica
105/ 104	59	63
120/ 119	69	73
135 / 134	79	84
150 / 149	89	94

connections & trims

M U D T

Intermediate Trim

The End Trim finished the end as thin panel in a change of height location

WHAT'S INCLUDED
intermediate trim, attachment hardware



PRODUCT OPTIONS

Height	Finish
015, 030	Foundation Mica

194

SAMPLE ORDER CODE

MUDT 015	Q
----------	---

DIMENSIONS CM

PRICING

H	Foundation	Mica
15 / 15	32	34
03 / 30	52	56

worksurfaces

worksurfaces

PRODUCT MAP / TABLE OF CONTENTS	197
WORKSURFACE OVERVIEW	200
WORKSURFACE BASICS	201
WORKSURFACE GRAIN/PATTERN DIRECTION	202
EDGE TRIM STYLE OVERVIEW	204
PRODUCT LISTING	206

MUNWR Rectangular Worksurface

Page 206
Depth: 50cm,60cm,70cm,80cm
Width:55cm - 240cm

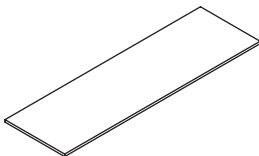

MUNWW Wedge Worksurface

Page 212
Depth A: 50cm,60cm,70cm
Width: 115cm-240cm
Depth B: 60cm,70cm,80cm

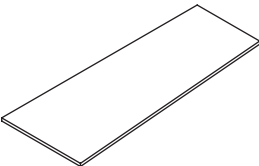

MUNWTN Transition Worksurface

Page 216
Depth A: 50cm,60cm,70cm
Return A: 50cm,60cm
Width: 175cm-240cm
Depth B: 70cm,80cm
Return B: 50cm,60cm

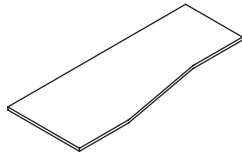

MUWDG 90° Corner Worksurface

Page 224
Depth:60cm,70cm,80cm
Width:120cm,140cm,150cm,160cm,180cm

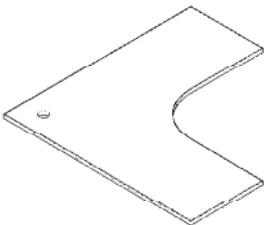

worksurface overview

District provides a variety of worksurface shapes for primary and secondary worksurfaces. The following outlines the features of District worksurfaces.

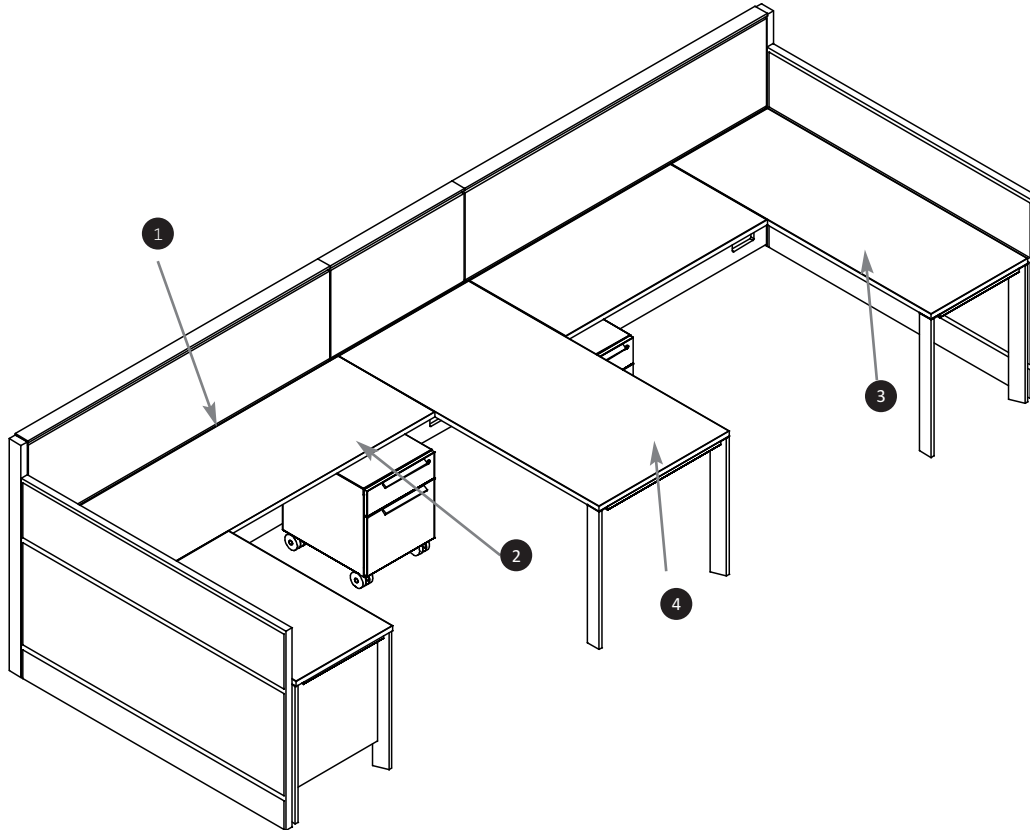

- 1 District surfaces are standard with a 2.5cm gap on the back side for cable access.
- 2 Worksurface widths are available in 2.5cm increments to allow for an optional 2.5cm gap on one or both sides of a worksurface and to match up with storage components (see Storage section).
- 3 Worksurfaces cannot span more than 180cm without additional floor support (see the Supports section for further details).
- 4 Worksurfaces can be panel wall- or storage-mounted or specified with legs to create freestanding or semi-supported surfaces (see Supports section).
Worksurfaces can be mounted on- or off-module...

The following workspace shapes are available in District.



Nominal depth dimensions shown

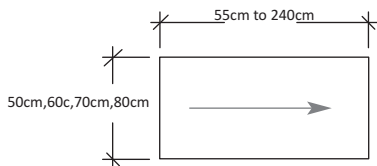

Rectangular Worksurface (MUNWR)

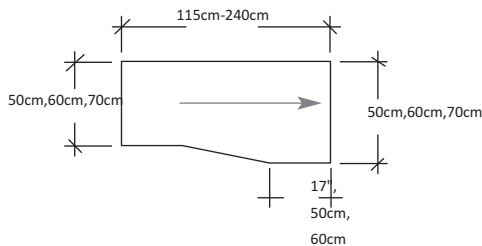

Transition Worksurface (MUNWT)

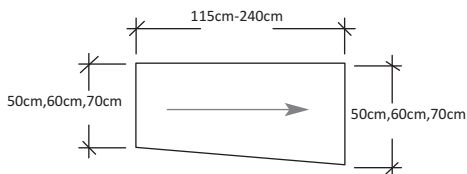

Wedge Worksurface (MUNWW)
(left and right handed available)

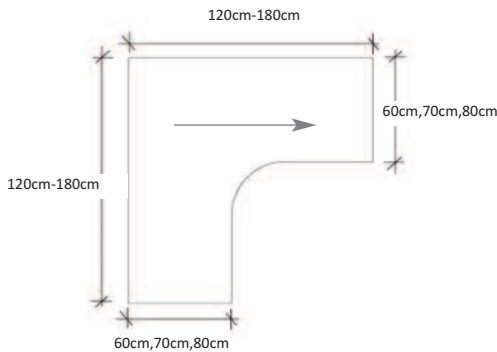

90° Corner Worksurface (MUWDG)

Finishes

- Worksurfaces are available in Foundation Laminate, Source Laminate
- Edge Trim are available in matching trim

worksurface grain/pattern direction

Attention to grain/pattern direction is important when planning worksurfaces.

- ❗ There is no user edge so care must be taken during installation to match grain/pattern direction
- Grain/patterns are not “centered” on worksurface or support
- Applies to Foundation Laminate (wood grain patterns)

worksurfaces

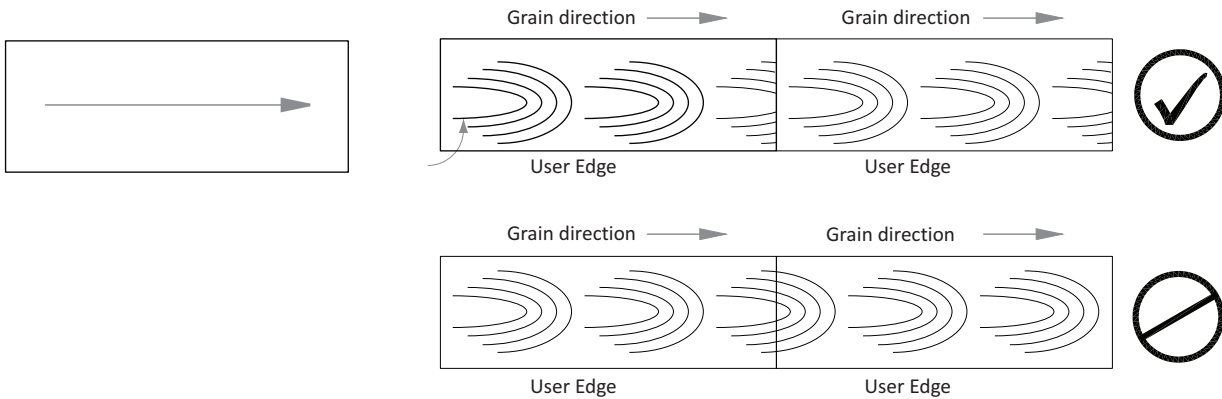

- Grain direction will appear in the same direction, from side to side
- Grain patterns are not centered on worksurface

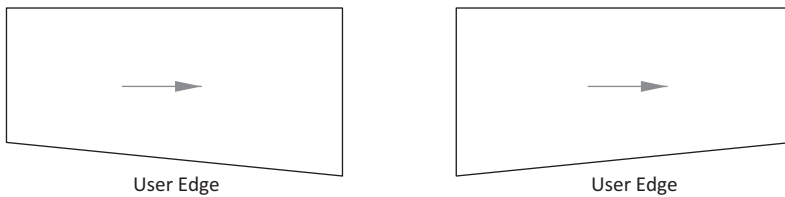

- Regardless of worksurface handedness, grain direction will run from side to side



worksurface grain/pattern direction (continued)

Attention to grain/pattern direction is important when planning worksurfaces. The following examples demonstrate this.

- ❗ • There is no user edge so care must be taken upon installation to match grain/pattern direction
- Grain/patterns are not “centered” on worksurface or support
- Includes Foundation Laminate

bridge worksurfaces

District does not offer a bridge worksurface so grain direction changes will always occur

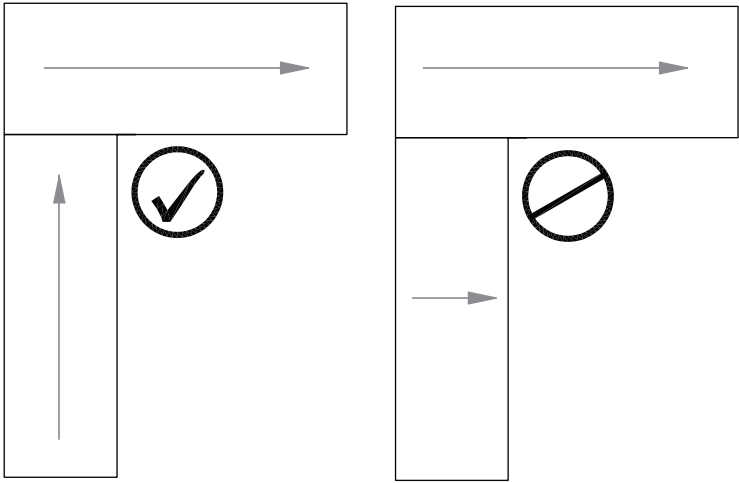

worksurfaces combined with supports

- Grain direction on Supports is always vertical
- There is no matching grain across Supports (A) and Worksurfaces (B)

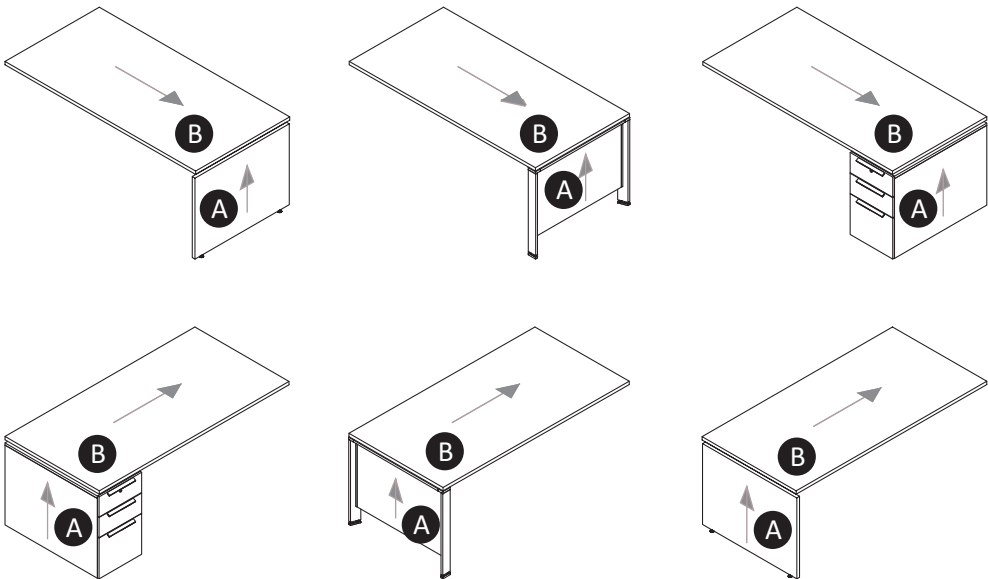

→ = Grain Direction = 

edge trim style overview

The chart below indicates which edge trim style can be specified with each District worksurface finish.

⚠ Both user edge and non-user edges have the same edge trim style

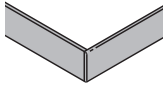
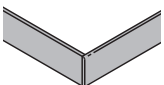
	Foundation Laminate Surface	Source Laminate
Straight (6) All Edges		

worksurfaces

MUNWR

Rectangular Worksurface

The Rectangle Worksurface provides a range of depths to support both primary and secondary worksurface applications.

WHAT'S INCLUDED

1 worksurface, grommet (if specified).

NOTES

Actual depth is 2cm less than nominal depth to allow for a cable management gap at the back and to align with storage.

Actual width equals nominal width, allowance for gaps at side edges must be specified.

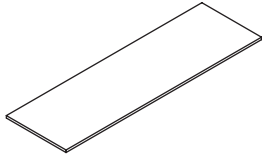

PRODUCT OPTIONS

Depth	Width	Grommet Location (Hole)	Worksurface Finish	Edge Trim Style
05, 06, 07, 08	055, 057, 060, 065 067, 070, 075, 077, 080, 085, 087, 090, 095, 097, 100, 115, 117, 120, 135, 137, 140, 145, 147, 150, 155, 157, 160, 175, 177, 180, 195, 197, 200, 215, 217, 220, 235, 237, 240	(N) No Grommet (L) Left (R) Right (C) Centre	Source Laminate Foundation Laminate	(6) PVC Straight

206

SAMPLE ORDER CODE

MUNWR 06	180	L	R1	06
----------	-----	---	----	----

DIMENSIONS CM

PRICING

D	W	SOURCE LAMINATE		FOUNDATION LAMINATE	
		Centre Grommet Hole	No Grommet Hole	Centre Grommet Hole	No Grommet Hole
050 / 50	055 / 55	217	159	256	198
050 / 50	057 / 57	217	159	256	198
050 / 50	060 / 60	217	159	256	198
050 / 50	065 / 65	226	168	268	210
050 / 50	067 / 67	226	168	268	210
050 / 50	070 / 70	235	177	279	221
050 / 50	075 / 75	235	177	279	221
050 / 50	070 / 77	245	187	291	233
050 / 50	080 / 80	245	187	291	233
050 / 50	085 / 85	253	195	301	243
050 / 50	087 / 87	253	195	301	243
050 / 50	090 / 90	253	195	301	243
050 / 50	095 / 95	258	200	308	250
050 / 50	097 / 97	258	200	308	250
050 / 50	100 / 100	264	206	315	257
050 / 50	115 / 115	264	206	315	257
050 / 50	117 / 117	273	215	326	268
050 / 50	120 / 120	273	215	326	268
050 / 50	135 / 135	332	274	400	342
050 / 50	137 / 137	332	274	400	342
050 / 50	140 / 140	342	284	412	354
050 / 50	145 / 145	342	284	412	354
050 / 50	147 / 147	350	292	423	365
050 / 50	150 / 150	350	292	423	365
050 / 50	155 / 155	357	299	431	373
050 / 50	157 / 157	357	299	431	373

If Grommet is specified, add 58

Pricing is continued on the following page.

M U N W R Rectangular Worksurface (Continued)

DIMENSIONS CM

PRICING

DIMENSIONS		SOURCE LAMINATE		FOUNDATION LAMINATE	
D	W	Centre Grommet Hole	No Grommet Hole	Centre Grommet Hole	No Grommet Hole
050 / 50	160 / 160	371	313	449	391
050 / 50	175 / 175	371	313	449	391
050 / 50	177 / 177	385	327	466	408
050 / 50	180 / 180	385	327	466	408
050 / 50	195 / 195	430	372	522	464
050 / 50	197 / 197	430	372	522	464
050 / 50	200 / 200	442	384	538	480
050 / 50	215 / 215	442	384	538	480
050 / 50	217 / 217	473	415	576	518
050 / 50	220 / 220	473	415	576	559
050 / 50	235 / 235	506	448	617	559
050 / 50	237 / 237	506	448	617	559
050 / 50	240 / 240	506	448	617	559
060 / 60	055 / 55	506	448	617	559
060 / 60	057 / 57	230	172	272	214
060 / 60	060 / 60	230	172	272	214
060 / 60	065 / 65	238	180	282	224
060 / 60	067 / 67	238	180	282	224
060 / 60	070 / 70	245	187	291	233
060 / 60	075 / 75	245	187	291	233
060 / 60	077 / 77	254	196	302	244
060 / 60	080 / 80	254	196	302	244
060 / 60	085 / 85	262	204	313	255
060 / 60	087 / 87	262	204	313	255
060 / 60	090 / 90	262	204	313	255
060 / 60	095 / 95	269	211	321	263
060 / 60	097 / 97	262	204	313	255
060 / 60	100 / 100	275	217	329	271
060 / 60	115 / 115	285	227	341	283
060 / 60	117 / 117	285	227	341	283
060 / 60	120 / 120	285	227	341	341
060 / 60	135 / 135	346	288	417	359
060 / 60	137 / 137	346	288	417	430
060 / 60	140 / 140	356	298	430	372
060 / 60	145 / 145	356	298	430	372
060 / 60	147 / 147	266	308	442	384
060 / 60	150 / 150	266	308	442	384

If Grommet is specified, add 58

Pricing is continued on the following page.

worksurfaces

M U N W R

Rectangular Worksurface (Continued)

DIMENSIONS
CM

PRICING

DIMENSIONS		SOURCE LAMINATE		FOUNDATION LAMINATE	
D	W	Centre Grommet Hole	No Grommet Hole	Centre Grommet Hole	No Grommet Hole
060 / 60	155 / 155	377	319	456	398
060 / 60	157 / 157	377	319	456	398
060 / 60	160 / 160	388	330	470	412
060 / 60	175 / 175	388	330	470	412
060 / 60	177 / 177	407	349	494	436
060 / 60	180 / 180	407	349	494	436
060 / 60	195 / 195	457	399	556	498
060 / 60	197 / 197	457	399	556	498
060 / 60	200 / 200	471	413	574	516
060 / 60	215 / 215	471	413	574	516
060 / 60	217 / 217	504	446	615	557
060 / 60	220 / 220	522	464	638	580
060 / 60	235 / 235	539	481	659	601
060 / 60	237 / 237	539	481	659	601
060 / 60	240 / 240	539	481	659	601
070 / 70	055 / 55	251	193	299	241
070 / 70	057 / 57	251	193	299	241
070 / 70	060 / 60	251	193	299	241
070 / 70	065 / 65	264	206	315	257
070 / 70	070 / 70	264	206	315	257
070 / 70	075 / 75	277	219	331	273
070 / 70	077 / 77	287	229	344	286
070 / 70	080 / 80	287	229	344	286
070 / 70	085 / 85	298	240	357	299
070 / 70	087 / 87	298	240	357	299
070 / 70	090 / 90	298	240	357	299
070 / 70	095 / 95	305	247	366	308
070 / 70	097 / 97	305	247	366	308
070 / 70	100 / 100	311	253	374	316
070 / 70	115 / 115	325	267	391	333
070 / 70	117 / 117	325	267	391	333
070 / 70	120 / 120	325	267	391	333
070 / 70	135 / 135	386	328	468	410
070 / 70	137 / 137	397	339	481	423
070 / 70	140 / 140	397	339	481	423
070 / 70	145 / 145	408	350	495	437
070 / 70	147 / 147	408	350	495	437

If Grommet is specified, add 58

Pricing is continued on the following page.

Rectangular Worksurface
(Continued)DIMENSIONS
CM

PRICING

D	W	SOURCE LAMINATE		FOUNDATION LAMINATE	
		Centre Grommet Hole	No Grommet Hole	Centre Grommet Hole	No Grommet Hole
070 / 70	150 / 150	408	350	495	437
070 / 70	155 / 155	427	369	519	461
070 / 70	157 / 157	427	369	519	461
070 / 70	160 / 160	444	386	540	482
070 / 70	175 / 175	478	420	583	525
070 / 70	177 / 177	478	420	583	525
070 / 70	180 / 180	478	420	583	525
070 / 70	195 / 195	546	488	668	610
070 / 70	197 / 197	564	506	690	632
070 / 70	200 / 200	564	506	690	632
070 / 70	215 / 215	602	544	738	680
070 / 70	217 / 217	602	544	738	680
070 / 70	220 / 220	624	566	680	707
070 / 70	235 / 235	645	587	791	733
070 / 70	237 / 237	645	587	791	733
070 / 70	240 / 240	645	587	791	733
080 / 80	055 / 55	282	224	337	279
080 / 80	057 / 57	282	224	337	279
080 / 80	060 / 60	282	224	279	279
080 / 80	065 / 65	298	240	357	299
080 / 80	067 / 67	298	240	357	299
080 / 80	070 / 70	314	256	377	319
080 / 80	075 / 75	314	256	377	319
080 / 80	077 / 77	325	267	391	333
080 / 80	080 / 80	325	267	391	333
080 / 80	085 / 85	334	276	403	345
080 / 80	087 / 87	334	276	403	345
080 / 80	090 / 90	334	276	408	345
080 / 80	095 / 95	342	284	413	355
080 / 80	097 / 97	342	284	413	355
080 / 80	100 / 100	349	291	421	363
080 / 80	115 / 115	364	306	440	382
080 / 80	117 / 117	364	306	440	382
080 / 80	120 / 120	364	306	440	382
080 / 80	135 / 135	440	382	535	477
080 / 80	137 / 137	450	392	548	490
080 / 80	140 / 140	450	392	548	490
080 / 80	145 / 145	460	402	560	502
080 / 80	147 / 147	460	402	560	502
080 / 80	150 / 150	460	402	560	502
080 / 80	155 / 155	473	415	576	518
080 / 80	157 / 157	473	415	576	518
080 / 80	160 / 160	502	444	613	555
080 / 80	175 / 175	541	483	661	603
080 / 80	177 / 177	541	483	661	603
080 / 80	180 / 180	541	483	661	603
080 / 80	195 / 195	620	562	760	702

If Grommet is specified, add 58

Pricing is continued on the following page.

worksurfaces

M U N W R

Rectangular Worksurface (Continued)

DIMENSIONS
CM

PRICING

DIMENSIONS CM		SOURCE LAMINATE		FOUNDATION LAMINATE	
		Centre Grommet Hole	No Grommet Hole	Centre Grommet Hole	No Grommet Hole
080 / 80	197 / 197	641	583	786	728
080 / 80	200 / 200	641	583	786	728
080 / 80	215 / 215	686	628	843	785
080 / 80	217 / 217	686	628	843	785
080 / 80	220 / 220	710	652	873	815
080 / 80	235 / 235	734	676	902	844
080 / 80	237 / 237	734	676	902	844
080 / 80	240 / 240	734	676	902	844

If Grommet is specified, add 58

worksurfaces

MUNWW

Wedge Worksurface

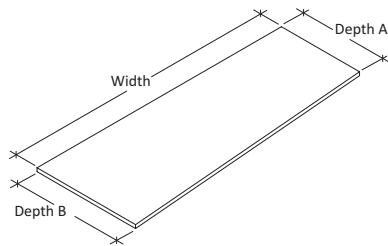

The Wedge Worksurface provides depth transition for primary worksurface applications.

WHAT'S INCLUDED

1 worksurface, grommet (if specified).

NOTES

The orientation (left or right) is determined by the location of the deepest end from the user's perspective.

Actual depth is 2.5cm less than nominal depth to allow for a cable management gap at the back and to align with storage.

Actual widths equals nominal width, allowance for gaps at side edges must be specified.

PRODUCT OPTIONS

Depth A	Width	Depth B	Orientation2	Grommet (Location)	Worksurface Finish	Edge Trim Style
05, 06, 07	115, 117, 120, 135, 137, 140, 145, 147, 150, 155, 157, 160, 175, 177, 180, 195, 197, 200, 215, 217, 235, 237, 240	06, 07, 08	L Left R Right	(L) Left (C) Centred (R) Right (N) No Grommet	Foundation Laminate Source Laminate	(6) PVC Straight

212

SAMPLE ORDER CODE

MUNW 06	180	07	L	L	R1	6
---------	-----	----	---	---	----	---

DIMENSIONS CM

PRICING

SOURCE LAMINATE, ORIENTATION LEFT OR RIGHT

DA	W	DB	No Grommet Source Laminate	No Grommet Foundation Laminate
050 / 50	115 / 115	070 / 70	325	267
050 / 50	117 / 117	070 / 70	325	267
050 / 50	120 / 120	070 / 70	325	267
050 / 50	135 / 135	070 / 70	386	328
050 / 50	137 / 137	070 / 70	397	339
050 / 50	140 / 140	070 / 70	397	339
050 / 50	145 / 145	070 / 70	397	339
050 / 50	147 / 147	070 / 70	408	350
050 / 50	150 / 150	070 / 70	408	350
050 / 50	155 / 155	070 / 70	427	369
050 / 50	157 / 157	070 / 70	427	369
050 / 50	160 / 160	070 / 70	444	386
050 / 50	175 / 175	070 / 70	478	420
050 / 50	177 / 177	070 / 70	478	420
050 / 50	180 / 180	070 / 70	478	420
050 / 50	195 / 195	070 / 70	544	488
050 / 50	197 / 197	070 / 70	564	506
050 / 50	200 / 200	070 / 70	564	506
050 / 50	215 / 215	070 / 70	602	544
050 / 50	217 / 217	070 / 70	602	544
050 / 50	220 / 220	070 / 70	624	566
050 / 50	235 / 235	070 / 70	645	587
050 / 50	237 / 237	070 / 70	645	587
050 / 50	240 / 240	070 / 70	645	587

If Grommet is specified, add 58

Pricing is continued on the following page.

M U N W W Wedge Worksurface (Continued)

DIMENSIONS
CM

PRICING

SOURCE
LAMINATE, ORIENTATION LEFT OR RIGHT

DA	W	DB	No Grommet Source Laminate	No Grommet Foundation Laminate
060 / 60	115 / 115	070 / 70	325	267
060 / 60	117 / 117	070 / 70	325	267
060 / 60	120 / 120	070 / 70	325	267
060 / 60	135 / 135	070 / 70	386	328
060 / 60	137 / 137	070 / 70	397	339
060 / 60	140 / 140	070 / 70	397	339
060 / 60	145 / 145	070 / 70	408	350
060 / 60	147 / 147	070 / 70	408	350
060 / 60	150 / 150	070 / 70	408	350
060 / 60	155 / 155	070 / 70	427	369
060 / 60	157 / 157	070 / 70	427	369
060 / 60	160 / 160	070 / 70	444	386
060 / 60	175 / 175	070 / 70	478	420
060 / 60	177 / 177	070 / 70	478	420
060 / 60	180 / 180	070 / 70	478	420
060 / 60	195 / 195	070 / 70	546	488
060 / 60	197 / 197	070 / 70	564	506
060 / 60	200 / 200	070 / 70	564	506
060 / 60	215 / 215	070 / 70	602	544
060 / 60	217 / 217	070 / 70	602	544
060 / 60	220 / 220	070 / 70	624	566
060 / 60	235 / 235	070 / 70	645	587
060 / 60	237 / 237	070 / 70	645	587
060 / 60	240 / 240	070 / 70	645	587
070 / 70	115 / 115	080 / 80	364	306
070 / 70	117 / 117	080 / 80	364	306
070 / 70	120 / 120	080 / 80	364	306
070 / 70	135 / 135	080 / 80	440	382
070 / 70	137 / 137	080 / 80	450	392
070 / 70	140 / 140	080 / 80	450	392
070 / 70	145 / 145	080 / 80	450	402
070 / 70	147 / 147	080 / 80	460	402
070 / 70	150 / 150	080 / 80	460	402
070 / 70	155 / 155	080 / 80	473	415
070 / 70	157 / 157	080 / 80	473	415
070 / 70	160 / 160	080 / 80	502	444
070 / 70	175 / 175	080 / 80	541	483
070 / 70	177 / 177	080 / 80	541	483
070 / 70	180 / 180	080 / 80	541	483
070 / 70	195 / 195	080 / 80	620	562
070 / 70	197 / 197	080 / 80	641	583
070 / 70	200 / 200	080 / 80	641	628
070 / 70	215 / 215	080 / 80	686	628
070 / 70	217 / 217	080 / 80	686	628
070 / 70	220 / 220	070 / 70	710	652
070 / 70	235 / 235	080 / 80	734	676
070 / 70	237 / 237	080 / 80	734	676
070 / 70	240 / 240	080 / 80	734	676

If Grommet is specified, add 58

Pricing is continued on the following page.

worksurfaces

M U N W W

Wedge Worksurface (Continued)

DIMENSIONS
CM

PRICING

FOUNDATION
LAMINATE, ORIENTATION LEFT OR RIGHT

DA	W	DB	No Grommet Source Laminate	No Grommet Foundation Laminate
050 / 50	115 / 115	070 / 70	391	333
050 / 50	117 / 117	070 / 70	391	333
050 / 50	120 / 120	070 / 70	391	333
050 / 50	135 / 135	070 / 70	468	410
050 / 50	137 / 137	070 / 70	481	423
050 / 50	140 / 140	070 / 70	481	423
050 / 50	145 / 145	070 / 70	481	423
050 / 50	147 / 147	070 / 70	495	423
050 / 50	150 / 150	070 / 70	495	437
050 / 50	155 / 155	070 / 70	519	461
050 / 50	157 / 157	070 / 70	519	461
050 / 50	160 / 160	070 / 70	540	482
050 / 50	175 / 175	070 / 70	583	525
050 / 50	177 / 177	070 / 70	583	525
050 / 50	180 / 180	070 / 70	583	525
050 / 50	195 / 195	070 / 70	668	610
050 / 50	197 / 197	070 / 70	690	632
050 / 50	200 / 200	070 / 70	690	680
050 / 50	215 / 215	070 / 70	738	680
050 / 50	217 / 217	070 / 70	738	680
050 / 50	220 / 220	070 / 70	765	707
050 / 50	235 / 235	070 / 70	791	733
050 / 50	237 / 237	070 / 70	791	733
050 / 50	240 / 240	070 / 70	791	733
060 / 60	115 / 115	070 / 70	391	333
060 / 60	117 / 117	070 / 70	391	333
060 / 60	120 / 120	070 / 70	391	333
060 / 60	135 / 135	070 / 70	468	410
060 / 60	137 / 137	070 / 70	481	423
060 / 60	140 / 140	070 / 70	481	423
060 / 60	145 / 145	070 / 70	495	437
060 / 60	147 / 147	070 / 70	495	437
060 / 60	150 / 150	070 / 70	495	437
060 / 60	155 / 155	070 / 70	519	519
060 / 60	157 / 157	070 / 70	519	519
060 / 60	160 / 160	070 / 70	540	540
060 / 60	175 / 175	070 / 70	583	583
060 / 60	177 / 177	070 / 70	583	583
060 / 60	180 / 180	070 / 70	583	583
060 / 60	195 / 195	070 / 70	668	668
060 / 60	197 / 197	070 / 70	690	690
060 / 60	200 / 200	070 / 70	690	690
060 / 60	215 / 215	070 / 70	738	738
060 / 60	217 / 217	070 / 70	738	738
060 / 60	220 / 220	070 / 70	765	765
060 / 60	235 / 235	070 / 70	791	791
060 / 60	237 / 237	070 / 70	791	791
060 / 60	240 / 240	070 / 70	791	791

If Grommet is specified, add 58

Pricing is continued on the following page.

M U N W W Wedge Worksurface (Continued)

DIMENSIONS
CM

PRICING

			FOUNDATION LAMINATE, ORIENTATION LEFT OR RIGHT	
DA	W	DB	No Grommet Source Laminate	No Grommet Foundation Laminate
070 / 70	115 / 115	080 / 80	440	382
070 / 70	117 / 117	080 / 80	440	382
070 / 70	120 / 120	080 / 80	440	382
070 / 70	135 / 135	080 / 80	535	477
070 / 70	137 / 137	080 / 80	548	490
070 / 70	140 / 140	080 / 80	548	490
070 / 70	145 / 145	080 / 80	560	502
070 / 70	147 / 147	080 / 80	560	502
070 / 70	150 / 150	080 / 80	560	502
070 / 70	155 / 155	080 / 80	576	518
070 / 70	157 / 157	080 / 80	576	518
070 / 70	160 / 160	080 / 80	613	555
070 / 70	175 / 175	080 / 80	661	603
070 / 70	177 / 177	080 / 80	661	603
070 / 70	180 / 180	080 / 80	661	603
070 / 70	195 / 195	080 / 80	760	702
070 / 70	197 / 197	080 / 80	786	728
070 / 70	200 / 200	080 / 80	786	728
070 / 70	215 / 215	080 / 80	843	785
070 / 70	217 / 217	080 / 80	843	785
070 / 70	220 / 220	080 / 80	873	815
070 / 70	235 / 235	080 / 80	902	844
070 / 70	237 / 237	080 / 80	902	844
070 / 70	240 / 240	080 / 80	902	844

If Grommet is specified, add 58

worksurfaces

MUNWTN

Transition Worksurface

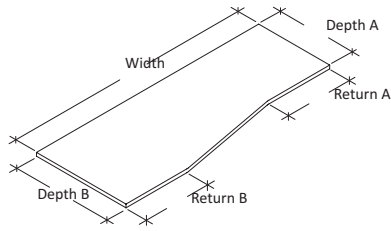

The Transition Worksurface provides depth transition capable of aligning with one or two secondary worksurfaces.

WHAT'S INCLUDED

1 worksurface, grommet (if specified).

NOTES

The orientation (left or right) is determined by the location of the deepest end from the user's perspective.

Actual depth is 2.5cm less than nominal depth to allow for a cable management gap at the back and to align with storage.

Actual widths equals nominal width, allowance for gaps at side edges must be specified.

PRODUCT OPTIONS

Depth A	Return A	Width (15cm increments)	Depth B	Return B	Orientation	Grommet Location	Worksurface Finish	Edge Trim Style
05, 06, 07	05, 06	175, 177, 180, 195, 197, 200, 215, 217, 220, 237, 240	07, 08	05, 06	L Left R Right	L Left C Centered R Right N No Grommet	Foundation Laminate Source Laminate	6 PVC Straight

SAMPLE ORDER CODE

MUNWTN 06	06	180	07	05	L	1	R1	6
-----------	----	-----	----	----	---	---	----	---

DIMENSIONS CM

PRICING

SOURCE LAMINATE, ORIENTATION LEFT OR RIGHT

DA	RA	W	DB	RB	No Grommet Source Laminate	No Grommet Foundation Laminate
050 / 50	050 / 50	175/175	070/70	050/50	478	420
050 / 50	050 / 50	175/175	070/70	060/60	478	420
050 / 50	050 / 50	177/177	070/70	050/50	478	420
050 / 50	050 / 50	177/177	070/70	060/60	478	420
050 / 50	050 / 50	180/180	070/70	050/50	478	420
050 / 50	050 / 50	180/180	070/70	060/60	478	420
050 / 50	050 / 50	195/195	070/70	050/50	546	488
050 / 50	050 / 50	195/195	070/70	060/60	546	488
050 / 50	050 / 50	197/197	070/70	050/50	564	506
050 / 50	050 / 50	197/197	070/70	060/60	564	506
050 / 50	050 / 50	200/200	070/70	050/50	564	506
050 / 50	050 / 50	200/200	070/70	060/60	564	506
050 / 50	050 / 50	215/215	070/70	050/50	602	544
050 / 50	050 / 50	215/215	070/70	060/60	602	544
050 / 50	050 / 50	217/217	070/70	050/50	544	602
050 / 50	050 / 50	217/217	070/70	060/60	602	544
050 / 50	050 / 50	220/220	070/70	050/50	624	566
050 / 50	050 / 50	220/220	070/70	060/60	624	566
050 / 50	050 / 50	235/235	070/70	050/50	645	587
050 / 50	050 / 50	235/235	070/70	060/60	645	587
050 / 50	050 / 50	237/237	070/70	050/50	645	587
050 / 50	050 / 50	237/237	070/70	060/60	645	587
050 / 50	050 / 50	240/240	070/70	050/50	645	587
050 / 50	050 / 50	240/240	070/70	060/60	645	587

If Grommet is specified, add 58

Pricing is continued on the following page.

M U N W T N Transition Worksurface (Continued)

DIMENSIONS
CM

PRICING

DIMENSIONS					PRICING	
CM					SOURCE	
DA	RA	W	DB	RB	LAMINATE	ORIENTATION LEFT OR RIGHT
					No Grommet Source Laminate	No Grommet Foundation Laminate
050 / 50	060 / 60	175/175	070/70	050/50	478	420
050 / 50	060 / 60	175/175	070/70	060/60	478	420
050 / 50	060 / 60	177/177	070/70	050/50	478	420
050 / 50	060 / 60	177/177	070/70	060/60	478	420
050 / 50	060 / 60	180/180	070/70	050/50	478	420
050 / 50	060 / 60	180/180	070/70	060/60	478	420
050 / 50	060 / 60	195/195	070/70	050/50	546	488
050 / 50	060 / 60	195/195	070/70	060/60	546	488
050 / 50	060 / 60	197/197	070/70	050/50	564	506
050 / 50	060 / 60	197/197	070/70	060/60	564	506
050 / 50	060 / 60	200/200	070/70	050/50	564	506
050 / 50	060 / 60	200/200	070/70	060/60	564	506
050 / 50	060 / 60	215/215	070/70	050/50	602	544
050 / 50	060 / 60	215/215	070/70	060/60	602	544
050 / 50	060 / 60	217/217	070/70	050/50	544	602
050 / 50	060 / 60	217/217	070/70	060/60	602	544
050 / 50	060 / 60	220/220	070/70	050/50	624	566
050 / 50	060 / 60	220/220	070/70	060/60	624	566
050 / 50	060 / 60	235/235	070/70	050/50	645	587
050 / 50	060 / 60	235/235	070/70	060/60	645	587
050 / 50	060 / 60	237/237	070/70	050/50	645	587
050 / 50	060 / 60	237/237	070/70	060/60	645	587
050 / 50	060 / 60	240/240	070/70	050/50	645	587
050 / 50	060 / 60	240/240	070/70	060/60	645	587
060 / 60	050 / 50	175/175	070/70	050/50	478	420
060 / 60	050 / 50	175/175	070/70	060/60	478	420
060 / 60	050 / 50	177/177	070/70	050/50	478	420
060 / 60	050 / 50	177/177	070/70	060/60	478	420
060 / 60	050 / 50	180/180	070/70	050/50	478	420
060 / 60	050 / 50	180/180	070/70	060/60	478	420
060 / 60	050 / 50	195/195	070/70	050/50	546	488
060 / 60	050 / 50	195/195	070/70	060/60	546	488
060 / 60	050 / 50	197/197	070/70	050/50	564	506
060 / 60	050 / 50	197/197	070/70	060/60	564	506
060 / 60	050 / 50	200/200	070/70	050/50	564	506
060 / 60	050 / 50	200/200	070/70	060/60	564	506
060 / 60	050 / 50	215/215	070/70	050/50	602	544
060 / 60	050 / 50	215/215	070/70	060/60	602	544
060 / 60	050 / 50	217/217	070/70	050/50	544	602
060 / 60	050 / 50	217/217	070/70	060/60	602	544
060 / 60	050 / 50	220/220	070/70	050/50	624	566
060 / 60	050 / 50	220/220	070/70	060/60	624	566
060 / 60	050 / 50	235/235	070/70	050/50	645	587
060 / 60	050 / 50	235/235	070/70	060/60	645	587
060 / 60	050 / 50	237/237	070/70	050/50	645	587
060 / 60	050 / 50	237/237	070/70	060/60	645	587
060 / 60	050 / 50	240/240	070/70	050/50	645	587
060 / 60	050 / 50	240/240	070/70	060/60	645	587

If Grommet is specified, add 58

Pricing is continued on the following page.

worksurfaces

M U N W T N

Transition Worksurface (Continued)

DIMENSIONS
CM

PRICING

SOURCE
LAMINATE, ORIENTATION LEFT OR RIGHT

DA	RA	W	DB	RB	No Grommet Source Laminate	No Grommet Foundation Laminate
060 / 60	060 / 60	175/175	070/70	050/50	478	420
060 / 60	060 / 60	175/175	070/70	060/60	478	420
060 / 60	060 / 60	177/177	070/70	050/50	478	420
060 / 60	060 / 60	177/177	070/70	060/60	478	420
060 / 60	060 / 60	180/180	070/70	050/50	478	420
060 / 60	060 / 60	180/180	070/70	060/60	478	420
060 / 60	060 / 60	195/195	070/70	050/50	546	488
060 / 60	060 / 60	195/195	070/70	060/60	546	488
060 / 60	060 / 60	197/197	070/70	050/50	564	506
060 / 60	060 / 60	197/197	070/70	060/60	564	506
060 / 60	060 / 60	200/200	070/70	050/50	564	506
060 / 60	060 / 60	200/200	070/70	060/60	564	506
060 / 60	060 / 60	215/215	070/70	050/50	602	544
060 / 60	060 / 60	215/215	070/70	060/60	602	544
060 / 60	060 / 60	217/217	070/70	050/50	544	602
060 / 60	060 / 60	217/217	070/70	060/60	602	544
060 / 60	060 / 60	220/220	070/70	050/50	624	566
060 / 60	060 / 60	220/220	070/70	060/60	624	566
060 / 60	060 / 60	235/235	070/70	050/50	645	587
060 / 60	060 / 60	235/235	070/70	060/60	645	587
060 / 60	060 / 60	237/237	070/70	050/50	645	587
060 / 60	060 / 60	237/237	070/70	060/60	645	587
060 / 60	060 / 60	240/240	070/70	050/50	645	587
060 / 60	060 / 60	240/240	070/70	060/60	645	587
070 / 70	050 / 50	175/175	080/80	050/50	541	483
070 / 70	050 / 50	175/175	080/80	060/60	541	483
070 / 70	050 / 50	177/177	080/80	050/50	541	483
070 / 70	050 / 50	177/177	080/80	060/60	541	483
070 / 70	050 / 50	180/180	080/80	050/50	541	483
070 / 70	050 / 50	180/180	080/80	060/60	541	483
070 / 70	050 / 50	195/195	080/80	050/50	620	562
070 / 70	050 / 50	195/195	080/80	060/60	620	562
070 / 70	050 / 50	197/197	080/80	050/50	641	583
070 / 70	050 / 50	197/197	080/80	060/60	641	583
070 / 70	050 / 50	200/200	080/80	050/50	641	583
070 / 70	050 / 50	200/200	080/80	060/60	641	583
070 / 70	050 / 50	215/215	080/80	050/50	686	628
070 / 70	050 / 50	215/215	080/80	060/60	686	628
070 / 70	050 / 50	217/217	080/80	050/50	686	628
070 / 70	050 / 50	217/217	080/80	060/60	686	628
070 / 70	050 / 50	220/220	080/80	050/50	710	652
070 / 70	050 / 50	220/220	080/80	060/60	710	652
070 / 70	050 / 50	235/235	080/80	050/50	734	676
070 / 70	050 / 50	235/235	080/80	060/60	734	676
070 / 70	050 / 50	237/237	080/80	050/50	734	676
070 / 70	050 / 50	237/237	080/80	060/60	734	676
070 / 70	050 / 50	240/240	080/80	050/50	734	676
070 / 70	050 / 50	240/240	080/80	060/60	734	676

If Grommet is specified, add 58

Pricing is continued on the following page.

218

M U N W T N Transition Worksurface (Continued)

DIMENSIONS CM

PRICING

					SOURCE LAMINATE, ORIENTATION LEFT OR RIGHT	
DA	RA	W	DB	RB	No Grommet Source Laminate	No Grommet Foundation Laminate
070 / 70	060 / 60	175/175	080/80	050/50	541	483
070 / 70	060 / 60	175/175	080/80	060/60	541	483
070 / 70	060 / 60	177/177	080/80	050/50	541	483
070 / 70	060 / 60	177/177	080/80	060/60	541	483
070 / 70	060 / 60	180/180	080/80	050/50	541	483
070 / 70	060 / 60	180/180	080/80	060/60	541	483
070 / 70	060 / 60	195/195	080/80	050/50	620	562
070 / 70	060 / 60	195/195	080/80	060/60	620	562
070 / 70	060 / 60	197/197	080/80	050/50	641	583
070 / 70	060 / 60	197/197	080/80	060/60	641	583
070 / 70	060 / 60	200/200	080/80	050/50	641	583
070 / 70	060 / 60	200/200	080/80	060/60	641	583
070 / 70	060 / 60	215/215	080/80	050/50	686	628
070 / 70	060 / 60	215/215	080/80	060/60	686	628
070 / 70	060 / 60	217/217	080/80	050/50	686	628
070 / 70	060 / 60	217/217	080/80	060/60	686	628
070 / 70	060 / 60	220/220	080/80	050/50	710	652
070 / 70	060 / 60	220/220	080/80	060/60	710	652
070 / 70	060 / 60	235/235	080/80	050/50	734	676
070 / 70	060 / 60	235/235	080/80	060/60	734	676
070 / 70	060 / 60	237/237	080/80	050/50	734	676
070 / 70	060 / 60	237/237	080/80	060/60	734	676
070 / 70	060 / 60	240/240	080/80	050/50	734	676
070 / 70	060 / 60	240/240	080/80	060/60	734	676

If Grommet is specified, add 58

Pricing is continued on the following page.

worksurfaces

M U N W T N

Transition Worksurface (Continued)

DIMENSIONS
CM

PRICING

FOUNDATION
LAMINATE, ORIENTATION LEFT OR RIGHT

DA	RA	W	DB	RB	No Grommet Source Laminate	No Grommet Foundation Laminate
050 / 50	050 / 50	175/175	070/70	050/50	583	525
050 / 50	050 / 50	175/175	070/70	060/60	583	525
050 / 50	050 / 50	177/177	070/70	050/50	583	525
050 / 50	050 / 50	177/177	070/70	060/60	583	525
050 / 50	050 / 50	180/180	070/70	050/50	583	525
050 / 50	050 / 50	180/180	070/70	060/60	583	525
050 / 50	050 / 50	195/195	070/70	050/50	668	610
050 / 50	050 / 50	195/195	070/70	060/60	668	610
050 / 50	050 / 50	197/197	070/70	050/50	690	632
050 / 50	050 / 50	197/197	070/70	060/60	690	632
050 / 50	050 / 50	200/200	070/70	050/50	690	632
050 / 50	050 / 50	200/200	070/70	060/60	690	632
050 / 50	050 / 50	215/215	070/70	050/50	738	680
050 / 50	050 / 50	215/215	070/70	060/60	738	680
050 / 50	050 / 50	217/217	070/70	050/50	738	680
050 / 50	050 / 50	217/217	070/70	060/60	738	680
050 / 50	050 / 50	220/220	070/70	050/50	765	707
050 / 50	050 / 50	220/220	070/70	060/60	791	733
050 / 50	050 / 50	235/235	070/70	050/50	791	733
050 / 50	050 / 50	235/235	070/70	060/60	791	733
050 / 50	050 / 50	237/237	070/70	050/50	791	733
050 / 50	050 / 50	237/237	070/70	060/60	791	733
050 / 50	050 / 50	240/240	070/70	050/50	791	733
050 / 50	050 / 50	240/240	070/70	060/60	791	733
050 / 50	060 / 60	175/175	070/70	050/50	583	525
050 / 50	060 / 60	175/175	070/70	060/60	583	525
050 / 50	060 / 60	177/177	070/70	050/50	583	525
050 / 50	060 / 60	177/177	070/70	060/60	583	525
050 / 50	060 / 60	180/180	070/70	050/50	583	525
050 / 50	060 / 60	180/180	070/70	060/60	583	525
050 / 50	060 / 60	195/195	070/70	050/50	668	610
050 / 50	060 / 60	195/195	070/70	060/60	668	610
050 / 50	060 / 60	197/197	070/70	050/50	690	632
050 / 50	060 / 60	197/197	070/70	060/60	690	632
050 / 50	060 / 60	200/200	070/70	050/50	690	632
050 / 50	060 / 60	200/200	070/70	060/60	690	632
050 / 50	060 / 60	215/215	070/70	050/50	738	680
050 / 50	060 / 60	215/215	070/70	060/60	738	680
050 / 50	060 / 60	217/217	070/70	050/50	738	680
050 / 50	060 / 60	217/217	070/70	060/60	738	680
050 / 50	060 / 60	220/220	070/70	050/50	765	707
050 / 50	060 / 60	220/220	070/70	060/60	791	733
050 / 50	060 / 60	235/235	070/70	050/50	791	733
050 / 50	060 / 60	235/235	070/70	060/60	791	733
050 / 50	060 / 60	237/237	070/70	050/50	791	733
050 / 50	060 / 60	237/237	070/70	060/60	791	733
050 / 50	060 / 60	240/240	070/70	050/50	791	733
050 / 50	060 / 60	240/240	070/70	060/60	791	733

If Grommet is specified, add 58

Pricing is continued on the following page.

M U N W T N Transition Worksurface (Continued)

DIMENSIONS
CM

PRICING

FOUNDATION
LAMINATE, ORIENTATION LEFT OR RIGHT

DA	RA	W	DB	RB	No Grommet Source Laminate	No Grommet Foundation Laminate
060 / 60	060 / 60	175/175	070/70	050/50	583	525
060 / 60	060 / 60	175/175	070/70	060/60	583	525
060 / 60	060 / 60	177/177	070/70	050/50	583	525
060 / 60	060 / 60	177/177	070/70	060/60	583	525
060 / 60	060 / 60	180/180	070/70	050/50	583	525
060 / 60	060 / 60	180/180	070/70	060/60	583	525
060 / 60	060 / 60	195/195	070/70	050/50	668	610
060 / 60	060 / 60	195/195	070/70	060/60	668	610
060 / 60	060 / 60	197/197	070/70	050/50	690	632
060 / 60	060 / 60	197/197	070/70	060/60	690	632
060 / 60	060 / 60	200/200	070/70	050/50	690	632
060 / 60	060 / 60	200/200	070/70	060/60	690	632
060 / 60	060 / 60	215/215	070/70	050/50	738	680
060 / 60	060 / 60	215/215	070/70	060/60	738	680
060 / 60	060 / 60	217/217	070/70	050/50	738	680
060 / 60	060 / 60	217/217	070/70	060/60	738	680
060 / 60	060 / 60	220/220	070/70	050/50	765	707
060 / 60	060 / 60	220/220	070/70	060/60	791	733
060 / 60	060 / 60	235/235	070/70	050/50	791	733
060 / 60	060 / 60	235/235	070/70	060/60	791	733
060 / 60	060 / 60	237/237	070/70	050/50	791	733
060 / 60	060 / 60	237/237	070/70	060/60	791	733
060 / 60	060 / 60	240/240	070/70	050/50	791	733
060 / 60	060 / 60	240/240	070/70	060/60	791	733
070 / 70	050 / 50	175/175	070/70	050/50	661	603
070 / 70	050 / 50	175/175	070/70	060/60	661	603
070 / 70	050 / 50	177/177	070/70	050/50	661	603
070 / 70	050 / 50	177/177	070/70	060/60	661	603
070 / 70	050 / 50	180/180	070/70	050/50	661	603
070 / 70	050 / 50	180/180	070/70	060/60	661	603
070 / 70	050 / 50	195/195	070/70	050/50	760	702
070 / 70	050 / 50	195/195	070/70	060/60	760	702
070 / 70	050 / 50	197/197	070/70	050/50	786	728
070 / 70	050 / 50	197/197	070/70	060/60	786	728
070 / 70	050 / 50	200/200	070/70	050/50	786	728
070 / 70	050 / 50	200/200	070/70	060/60	786	728
070 / 70	050 / 50	215/215	070/70	050/50	843	785
070 / 70	050 / 50	215/215	070/70	060/60	843	785
070 / 70	050 / 50	217/217	070/70	050/50	843	785
070 / 70	050 / 50	217/217	070/70	060/60	843	785
070 / 70	050 / 50	220/220	070/70	050/50	873	815
070 / 70	050 / 50	220/220	070/70	060/60	873	815
070 / 70	050 / 50	235/235	070/70	050/50	902	844
070 / 70	050 / 50	235/235	070/70	060/60	902	844
070 / 70	050 / 50	237/237	070/70	050/50	902	844
070 / 70	050 / 50	237/237	070/70	060/60	902	844
070 / 70	050 / 50	240/240	070/70	050/50	902	844
070 / 70	050 / 50	240/240	070/70	060/60	902	844

If Grommet is specified, add 58

Pricing is continued on the following page.

worksurfaces

M U N W T N

Transition Worksurface (Continued)

DIMENSIONS
CM

PRICING

FOUNDATION
LAMINATE, ORIENTATION LEFT OR RIGHT

DA	RA	W	DB	RB	No Grommet Source Laminate	No Grommet Foundation Laminate
060 / 60	060 / 60	175/175	070/70	050/50	583	525
060 / 60	060 / 60	175/175	070/70	060/60	583	525
060 / 60	060 / 60	177/177	070/70	050/50	583	525
060 / 60	060 / 60	177/177	070/70	060/60	583	525
060 / 60	060 / 60	180/180	070/70	050/50	583	525
060 / 60	060 / 60	180/180	070/70	060/60	583	525
060 / 60	060 / 60	195/195	070/70	050/50	668	610
060 / 60	060 / 60	195/195	070/70	060/60	668	610
060 / 60	060 / 60	197/197	070/70	050/50	690	632
060 / 60	060 / 60	197/197	070/70	060/60	690	632
060 / 60	060 / 60	200/200	070/70	050/50	690	632
060 / 60	060 / 60	200/200	070/70	060/60	690	632
060 / 60	060 / 60	215/215	070/70	050/50	738	680
060 / 60	060 / 60	215/215	070/70	060/60	738	680
060 / 60	060 / 60	217/217	070/70	050/50	738	680
060 / 60	060 / 60	217/217	070/70	060/60	738	680
060 / 60	060 / 60	220/220	070/70	050/50	765	707
060 / 60	060 / 60	220/220	070/70	060/60	791	733
060 / 60	060 / 60	235/235	070/70	050/50	791	733
060 / 60	060 / 60	235/235	070/70	060/60	791	733
060 / 60	060 / 60	237/237	070/70	050/50	791	733
060 / 60	060 / 60	237/237	070/70	060/60	791	733
060 / 60	060 / 60	240/240	070/70	050/50	791	733
060 / 60	060 / 60	240/240	070/70	060/60	791	733
070 / 70	050 / 50	175/175	080/80	050/50	661	603
070 / 70	050 / 50	175/175	080/80	060/60	661	603
070 / 70	050 / 50	177/177	080/80	050/50	661	603
070 / 70	050 / 50	177/177	080/80	060/60	661	603
070 / 70	050 / 50	180/180	080/80	050/50	661	603
070 / 70	050 / 50	180/180	080/80	060/60	661	603
070 / 70	050 / 50	195/195	080/80	050/50	760	702
070 / 70	050 / 50	195/195	080/80	060/60	760	702
070 / 70	050 / 50	197/197	080/80	050/50	786	728
070 / 70	050 / 50	197/197	080/80	060/60	786	728
070 / 70	050 / 50	200/200	080/80	050/50	786	728
070 / 70	050 / 50	200/200	080/80	060/60	786	728
070 / 70	050 / 50	215/215	080/80	050/50	843	785
070 / 70	050 / 50	215/215	080/80	060/60	843	785
070 / 70	050 / 50	217/217	080/80	050/50	843	785
070 / 70	050 / 50	217/217	080/80	060/60	843	785
070 / 70	050 / 50	220/220	080/80	050/50	873	815
070 / 70	050 / 50	220/220	080/80	060/60	873	815
070 / 70	050 / 50	235/235	080/80	050/50	902	844
070 / 70	050 / 50	235/235	080/80	060/60	902	844
070 / 70	050 / 50	237/237	080/80	050/50	902	844
070 / 70	050 / 50	237/237	080/80	060/60	902	844
070 / 70	050 / 50	240/240	080/80	050/50	902	844
070 / 70	050 / 50	240/240	080/80	060/60	902	844

If Grommet is specified, add 58

Pricing is continued on the following page.

M U N W T N Transition Worksurface (Continued)

DIMENSIONS CM

PRICING

FOUNDATION LAMINATE, ORIENTATION LEFT OR RIGHT

DA	RA	W	DB	RB	No Grommet Source Laminate	No Grommet Foundation Laminate
070 / 70	060 / 60	175/175	080/80	050/50	661	603
070 / 70	060 / 60	175/175	080/80	060/60	661	603
070 / 70	060 / 60	177/177	080/80	050/50	661	603
070 / 70	060 / 60	177/177	080/80	060/60	661	603
070 / 70	060 / 60	180/180	080/80	050/50	661	603
070 / 70	060 / 60	180/180	080/80	060/60	661	603
070 / 70	060 / 60	195/195	080/80	050/50	760	702
070 / 70	060 / 60	195/195	080/80	060/60	760	702
070 / 70	060 / 60	197/197	080/80	050/50	786	728
070 / 70	060 / 60	197/197	080/80	060/60	786	728
070 / 70	060 / 60	200/200	080/80	050/50	786	728
070 / 70	060 / 60	200/200	080/80	060/60	786	728
070 / 70	060 / 60	215/215	080/80	050/50	843	785
070 / 70	060 / 60	215/215	080/80	060/60	843	785
070 / 70	060 / 60	217/217	080/80	050/50	843	785
070 / 70	060 / 60	217/217	080/80	060/60	843	785
070 / 70	060 / 60	220/220	080/80	050/50	873	815
070 / 70	060 / 60	220/220	080/80	060/60	873	815
070 / 70	060 / 60	235/235	080/80	050/50	902	844
070 / 70	060 / 60	235/235	080/80	060/60	902	844
070 / 70	060 / 60	237/237	080/80	050/50	902	844
070 / 70	060 / 60	237/237	080/80	060/60	902	844
070 / 70	060 / 60	240/240	080/80	050/50	902	844
070 / 70	060 / 60	240/240	080/80	060/60	902	844

If Grommet is specified, add 58

worksurfaces

MUWDG 90° Corner Worksurface

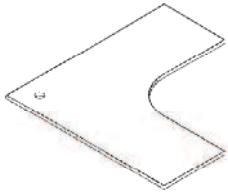

The Rectangle Worksurface provides a range of depths to support both primary and secondary worksurface applications.

WHAT'S INCLUDED
1 worksurface, grommet (if specified).

NOTES
Actual depth is 2cm less than nominal depth to allow for a cable management gap at the back and to align with storage.

Actual width equals nominal width, allowance for gaps at side edges must be specified.

PRODUCT OPTIONS

Depth	Width	Grommet Hole	Worksurface Finish	Edge Trim Style
06, 07, 08	115, 117, 120, 135, 140, 145, 147, 150, 155, 157, 160, 175, 177, 180	(N) No Grommet (C) Center	Source Laminate Foundation Laminate	(6) PVC Straight

SAMPLE ORDER CODE

MUWDG 06	180	C	R1	6
----------	-----	---	----	---

DIMENSIONS CM

PRICING

D	W	90DEG WORKSURFACE SOURCE LAMINATE		FOUNDATION LAMINATE	
		Centred Grommet Hole	No Grommet Hole	Centre Grommet Hole	No Grommet Hole
060 / 60	115 / 115	626	610	1180	1164
060 / 60	117 / 117	626	610	1180	1164
060 / 60	120 / 120	626	610	1180	1164
060 / 60	135 / 135	626	610	1180	1164
060 / 60	140 / 140	626	610	N/A	N/A
060 / 60	145 / 145	681	665	N/A	N/A
060 / 60	147 / 147	681	665	N/A	N/A
060 / 60	150 / 150	681	665	N/A	N/A
060 / 60	155 / 155	764	748	N/A	N/A
060 / 60	157 / 157	764	748	N/A	N/A
060 / 60	160 / 160	764	748	N/A	N/A
060 / 60	175 / 175	903	887	N/A	N/A
060 / 60	177 / 177	903	887	N/A	N/A
060 / 60	180 / 180	903	887	N/A	N/A

If Grommet is specified, add 58

Pricing is continued on the following page.

MUWDG
90° Corner Worksurface

DIMENSIONS
CM

PRICING

DIMENSIONS CM		90DEG WORKSURFACE SOURCE LAMINATE		FOUNDATION LAMINATE	
		Centred Grommet Hole	No Grommet Hole	Centre Grommet Hole	No Grommet Hole
070 / 70	115 / 115	626	610	1180	1164
070 / 70	117 / 117	626	610	1180	1164
070 / 70	120 / 120	626	610	1180	1164
070 / 70	135 / 135	626	610	1180	1164
070 / 70	140 / 140	626	610	N/A	N/A
070 / 70	145 / 145	681	665	N/A	N/A
070 / 70	147 / 147	681	665	N/A	N/A
070 / 70	150 / 150	681	665	N/A	N/A
070 / 70	155 / 155	764	748	N/A	N/A
070 / 70	157 / 157	764	748	N/A	N/A
070 / 70	160 / 160	764	748	N/A	N/A
070 / 70	175 / 175	903	887	N/A	N/A
070 / 70	177 / 177	903	887	N/A	N/A
070 / 70	180 / 180	903	887	N/A	N/A
080 / 80	115 / 115	626	610	1180	1164
080 / 80	117 / 117	626	610	1180	1164
080 / 80	120 / 120	626	610	1180	1164
080 / 80	135 / 135	626	610	1180	1164
080 / 80	140 / 140	626	610	N/A	N/A
080 / 80	145 / 145	681	665	N/A	N/A
080 / 80	147 / 147	681	665	N/A	N/A
080 / 80	150 / 150	681	665	N/A	N/A
080 / 80	155 / 155	764	748	N/A	N/A
080 / 80	157 / 157	764	748	N/A	N/A
080 / 80	160 / 160	764	748	N/A	N/A
080 / 80	175 / 175	903	887	N/A	N/A
080 / 80	177 / 177	903	887	N/A	N/A
080 / 80	180 / 180	903	887	N/A	N/A

If Grommet is specified, add 58

storage

storage

PRODUCT MAP / TABLE OF CONTENTS	227
UNDERSTANDING DISTRICT STORAGE	230
STORAGE OVERVIEW	233
PEDESTAL BASICS	234
BOOKCASE BASICS	235
CREDENZA BASICS	236
CREDENZA DRAWER WIDTHS	237
TOWER BASICS	240
PRODUCT LISTING	242

product map

MUPR Rolling Pedestal

Page 242

Depth: 48cm / Width: 41cm / Height: 53cm

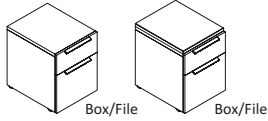

With Cushion

MUFLS Lateral File – Standard

Page 243

Height: 90cm & 104cm / Depth: 41cm & 48cm / Width: 60cm, 80cm, 90cm

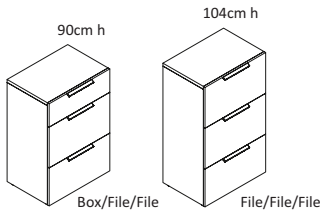

MUBKS Bookcase – Standard

Page 244

Height: 90cm, 104cm, 135cm / Width: 60cm-120cm / Depth: 41cm

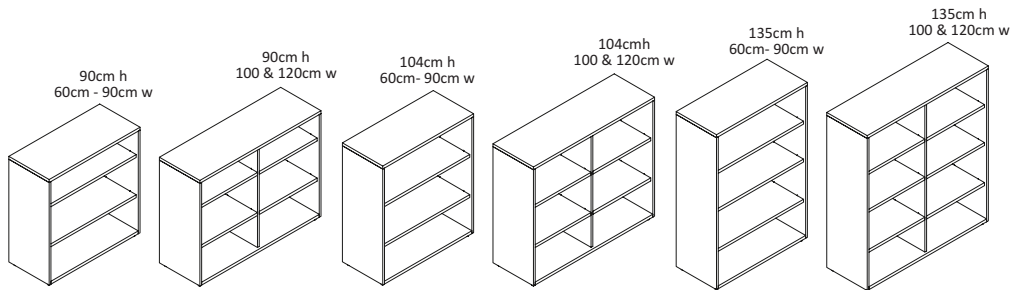

MULHE Low Open with Drawer Credenza – Elevated

Page 245

Depth: 41cm & 48cm / Width: 120cm - 220cm / Height: 53cm

Open Compartment also available on right side

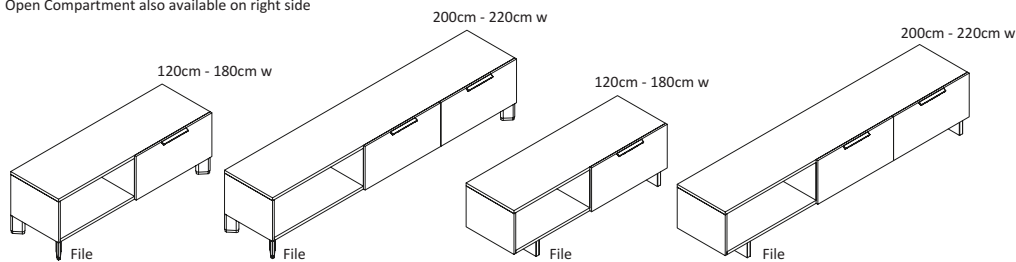

Angled Foot

District Foot (48cm depth only)

MUTW Side Open Tower

Page 246

Height: 90cm 104cm, 135cm/ Depth: 50cm, 60cm, 70cm & 80cm/ Width: 41cm

Opening also available on left side

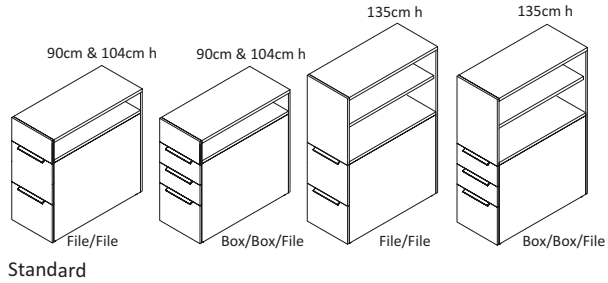

MUNSLB Linking Bracket

Page 247

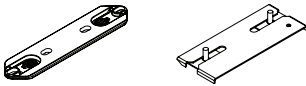

MUNSXL Storage Extended Leveling Kit

Page 248

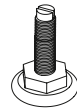

understanding district storage

District storage can be planned as space division, panel or worksurface support, or in a more conventional manner where it is incorporated into panel environments. A wide variety of finish protocols are available to suit different planning styles and budgets.

district storage styles

- District is available in three different styles and each provides a different function, and varying levels of power and communication access

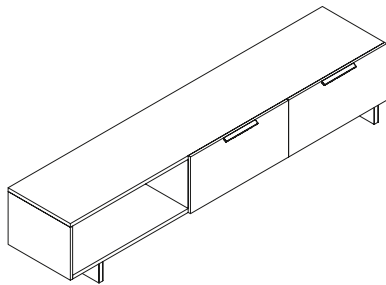

- Elevated Storage with District Feet provides a lighter aesthetic by raising the storage 15cm off the floor
- Available on 48cm deep credenzas only
- Power and data communications cannot be passed through the storage

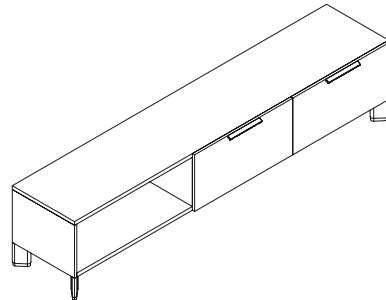

- Elevated Storage with Angled Feet provides the most options and flexibility. The legs are on the corners, allowing a power and communications channel to pass along the bottom of the storage to provide power in the storage at either beltline or base level

understanding district storage (continued)

maximized support

- Worksurface support has been maximized so that virtually any storage component can serve as support for worksurfaces (See Supports section for actual support brackets required)

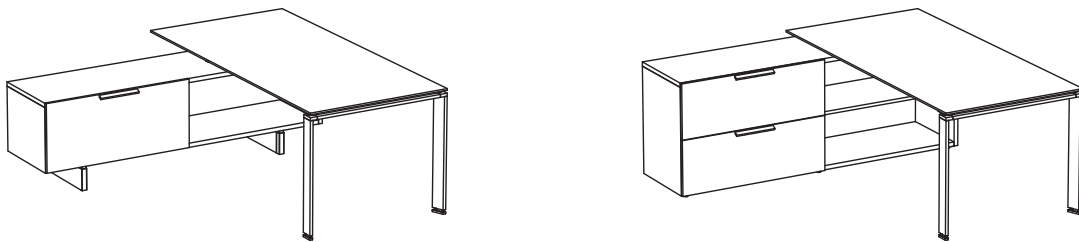

231

- Storage units that can attach to panels to provide support are complete with slots on the back to accept the support brackets. This allows for maximum flexibility because holes do not need to be drilled into the units exterior surface for mounting the brackets

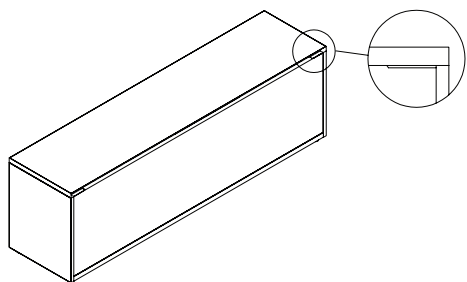

Credenza – Back View

storage

understanding district storage (continued)

layering

- District provides the opportunity to layer worksurfaces over storage to allow for extra piling surfaces
- The amount of piling worksurface area is maximized by the gap between the shelf at 90cm high, the worksurface at 74cm high and the credenza at 53cm high

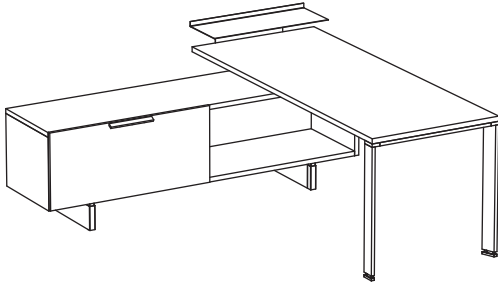

standard storage heights

- 2.5cm of levelers are included in the total height of the storage (eg. If height is 104cm, actual height of the case is 102cm and levelers, fully extended, make up 25cm)

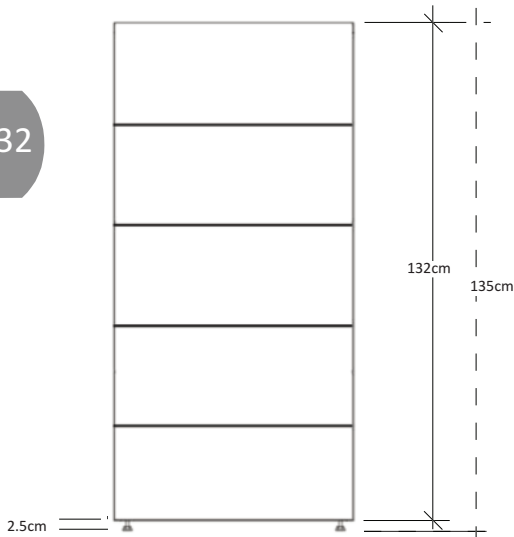

232

leveling range

standard storage

- The following storage units (MUFLS, MUTW) will receive extended levelers (MUNSXL) which will allow the unit to be levelled 1.2cm down and 1.6cm up
- All other units will have a standard leveler which will allow for levelling 1.2cm down and 0cm up.

elevated storage

- Leveling range of 1.2cm down and 64cm up

storage overview

District storage is available in a variety of formats, from pedestals, to stackers and lockers. The following outlines the various storage options available.

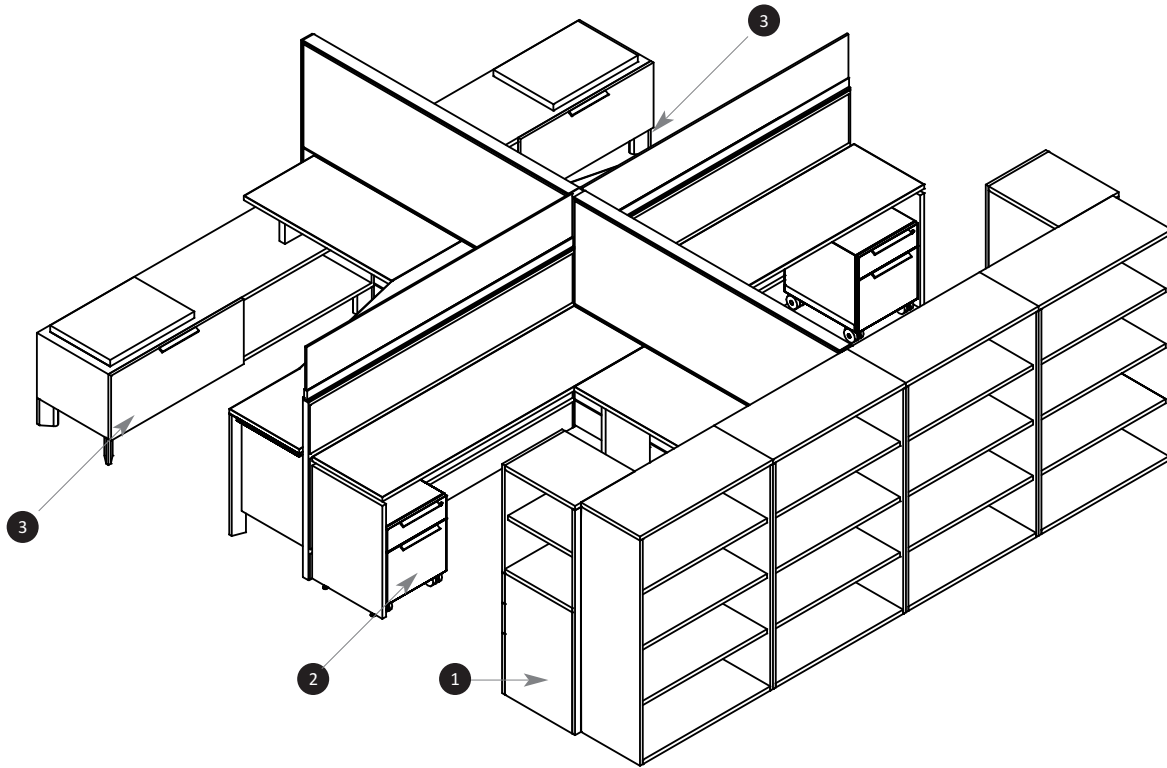

- 1 Towers combine box and file and open compartments in side locations.
- 2 Undersurface storage includes rolling pedestals
- 3 Credenza options include open with drawer

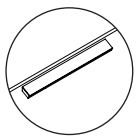

District Handle Pull

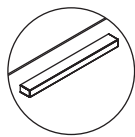

Rectangular Handle Pull

Finishes

- All storage is available in Laminate finishes
- Laminate cases are not available in 240cm wide
- Handles and feet are available in Platinum, Storm White, Espresso, Ebony and Latte
- Grommets are finished in Platinum

bookcase basics

The following outlines the features of District bookcases.

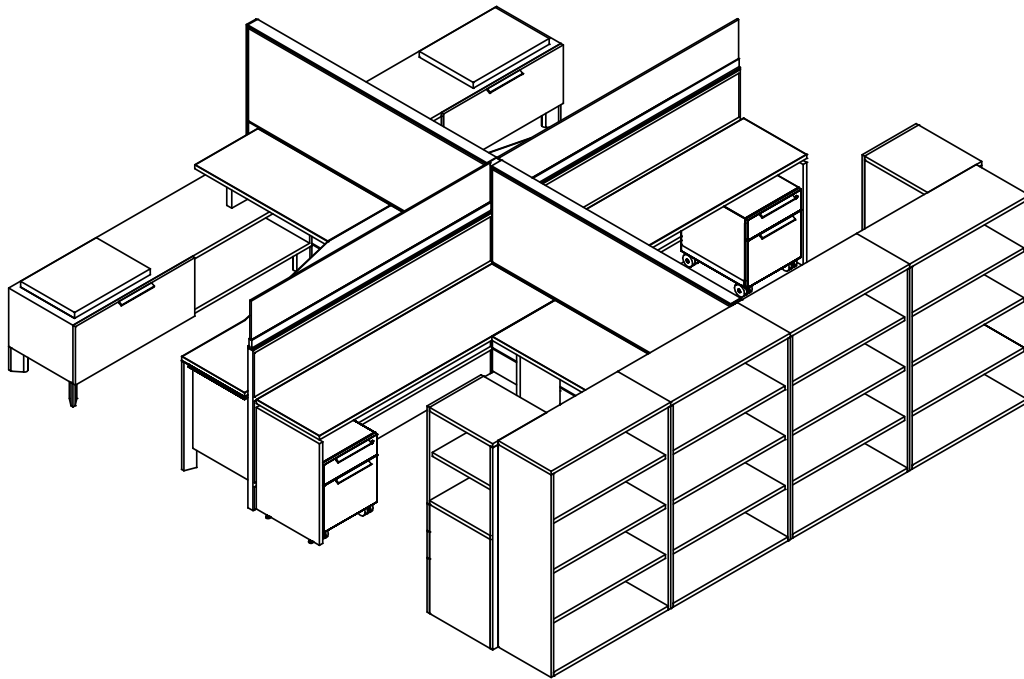

60cm, 80cm, 90cm widths

100cm, 120cm widths

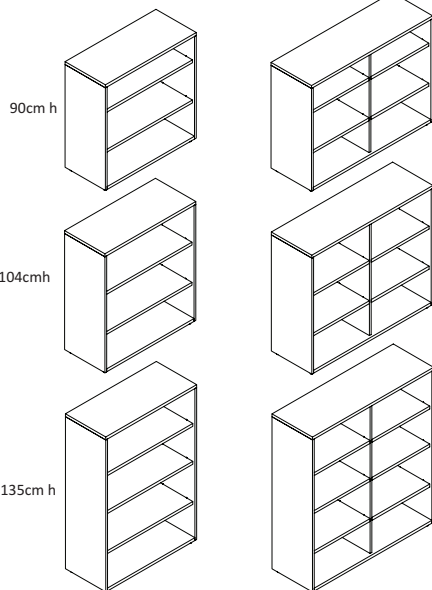

Bookcase – Standard (MUBKS)

- Provides open book storage within a workstation
- Available in heights of 90cm, 104cm, and 135cm and widths 60cm-120cm
- The number of shelves varies by height and width

credenza basics

low open with drawer credenzas

- Available 53cm high and in depths of 41cm and 48cm
- Available in widths from 120cm to 220cm
- Consists of one open section and one or two filing sections depending on width
- Cabinets are handed, determined by the location of the open section
- 41cm deep credenzas do not have full extension filing (see filing charts for filing capacity)

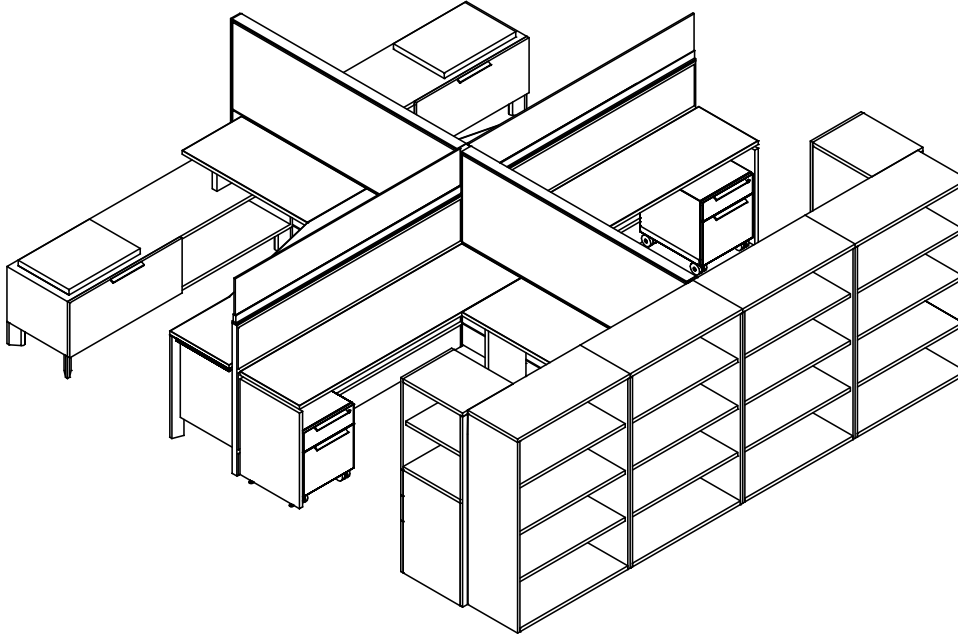

236

Low Open with Drawer Credenza – Elevated (MULHE)

- Available with a file drawer configuration and a single-height opening
- 41cm deep credenzas are available with angled feet and the option of Base Back Cut Out or Base and Top Grommets
- 48cm deep credenzas are available with angled feet and the option of Base Back Cut Out or Base and Top Grommets, or with District feet, which has no option for grommets
- If Base Back Cut Out is selected, cut out will appear on the back of the section with the drawer. If the width of the credenza is longer than 200cm (two drawers) then the cut out is at the end section (not the center). If Base & Top Grommet is selected, it will appear in the open section of the credenza

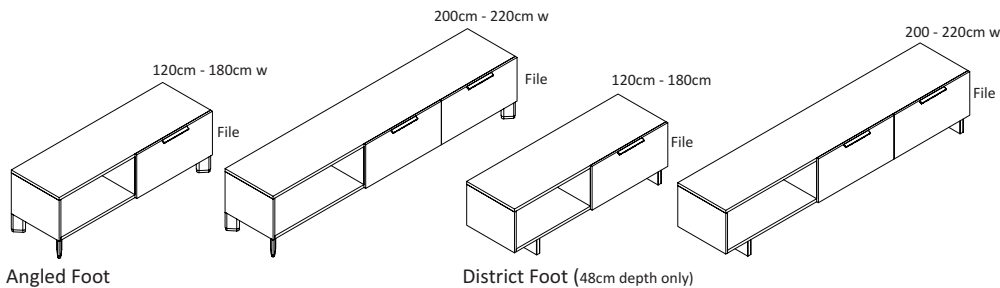

credenza drawer widths

The following illustrates District credenza drawer and open section widths.

120cm Width

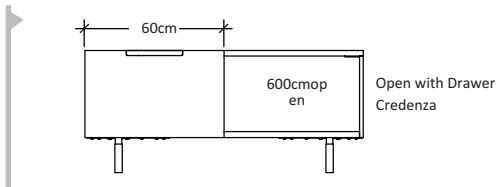

140cm Width

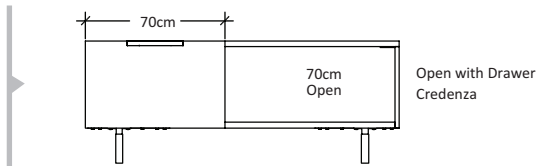

150cm Width

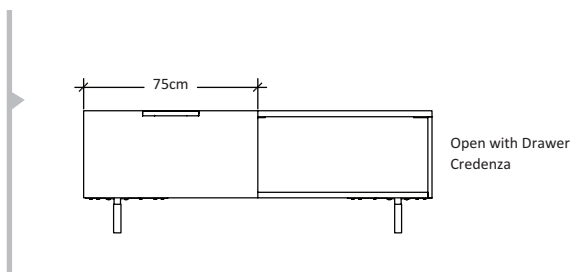

storage

credenza drawer widths (continued)

The following illustrates District credenza drawer and open section widths.

180cm Width

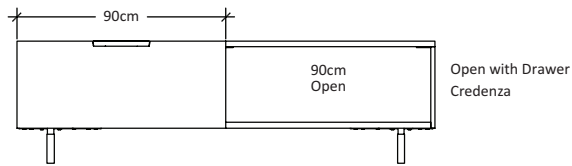

200cm Width

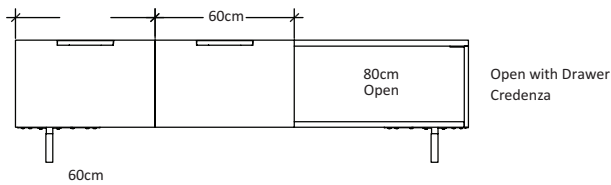

238

220cm Width

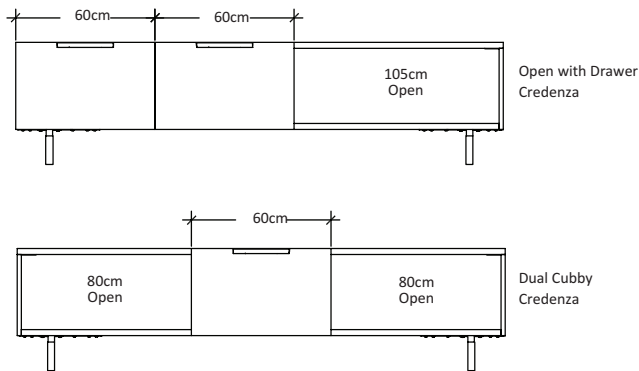

credenza drawer widths (continued)

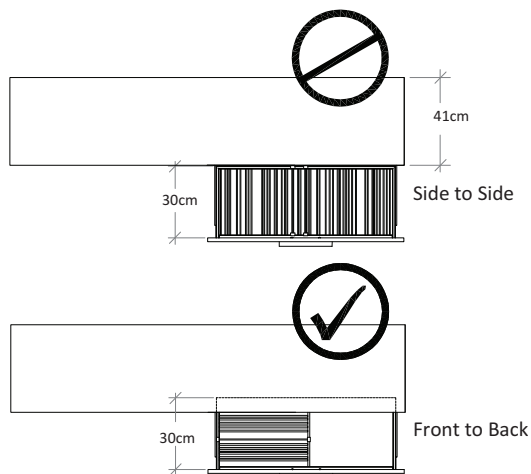
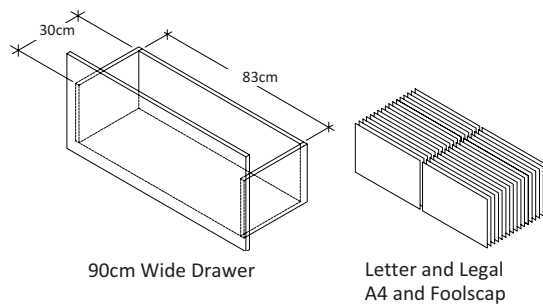
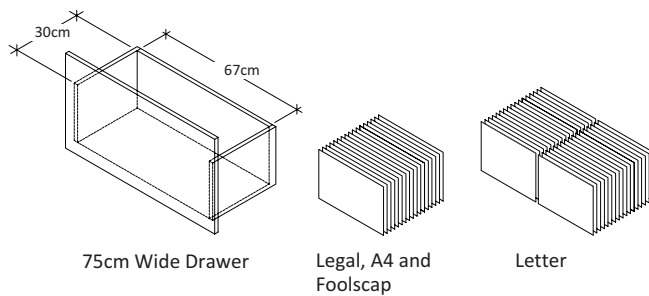
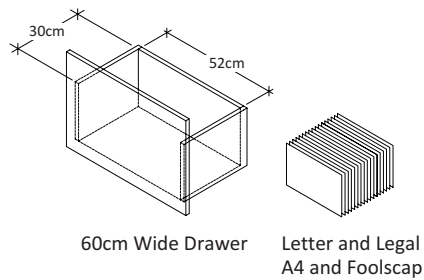

- 41cm deep file drawers do not have full extension files
- Filing must be front-to-back not side-to-side
- On 60cmwidth file drawers only one front-to-back filing section can be used (letter, legal, A4 or foolscap)
- On 75cmwidth file drawers two front-to-back filing sections can be used (letter) or one filing section (legal, A4 or foolscap)
- On 90cm width filing drawers, front-to-back filing sections can be used (letter, legal, A4 or foolscap)

tower basics

side open towers

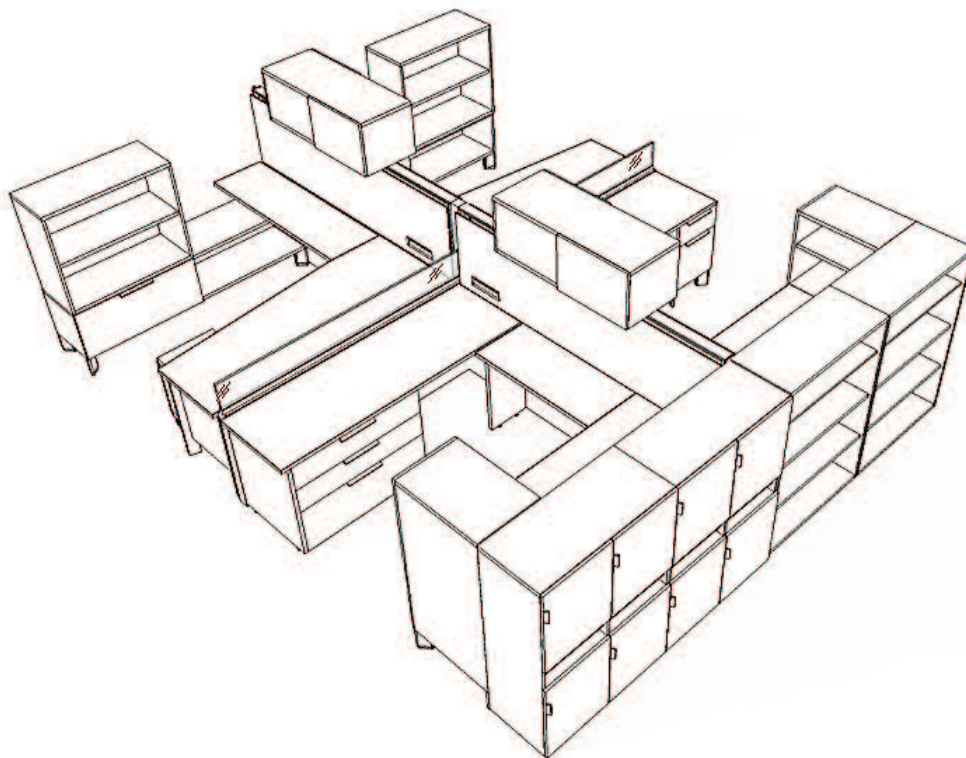

240

Side Open Tower Standard (MUTW)

- Contains front facing box/file drawer or file/file drawer for standard, plus side open shelves
- Available in standard styles
- Available in heights of 90cm, 104cm, 135cm, 165cm and depths of 50cm, 60cm, 70cm, or 90cm
- Open shelves have a solid back, therefore the units are handed, handedness being determined by the side with the open shelves
- Unable to be powered

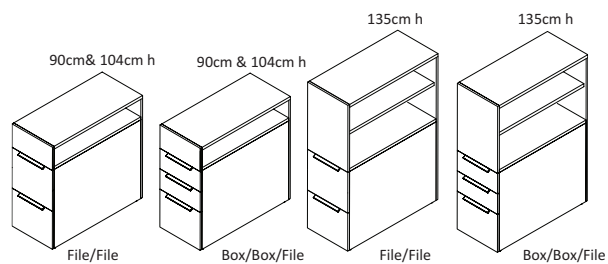

Standard

tower basics (continued)

The following outlines the features of storage-to-storage support.

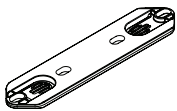
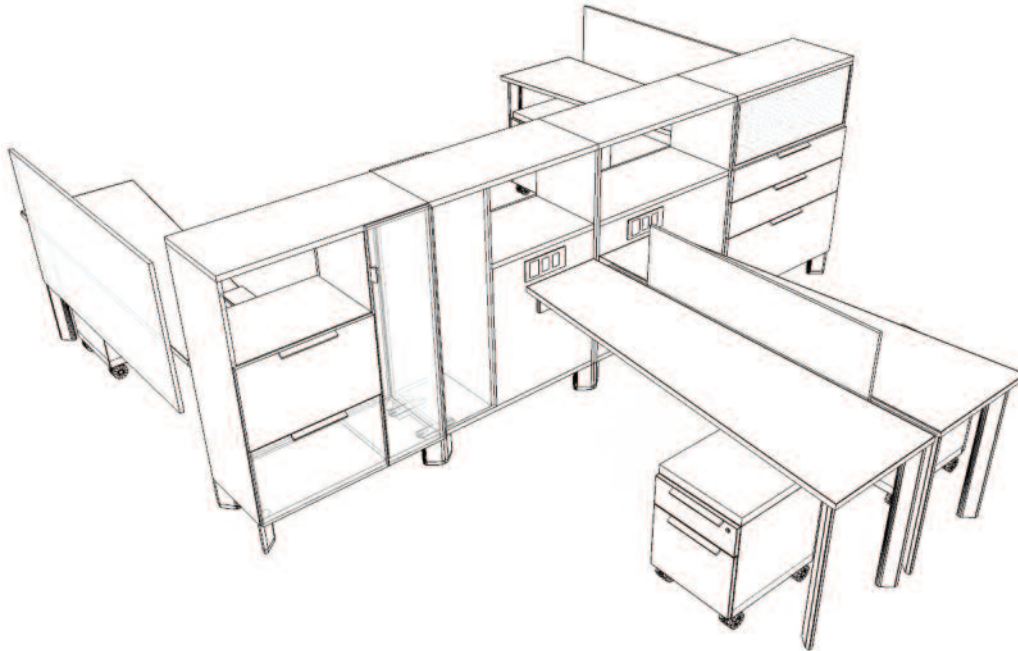

For Elevated Storage

Linking Bracket for Elevated Storage (MUNSLBE)

- Connect storage units together
- Used to align cabinets in space applications
- Must be used when routing electrics beneath a storage spine

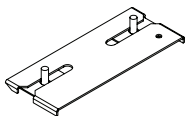

For Standard Storage

Linking Bracket for Standard Storage (MUNSLBS)

- Standard storage units can be linked together for alignment and stability

storage

M U P R Rolling Pedestal

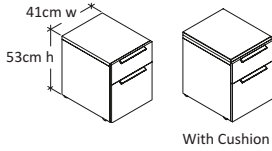

The Rolling Pedestal provides mobile filing storage with optional Seat Cushion for temporary guest seating.

WHAT'S INCLUDED

1 cabinet, drawers with pulls (as specified), 4 casters, lock and keys (if specified) and Seat Cushion (MUWLC), if specified.

WHAT'S EXCLUDED

A Seat Cushion (MUWLC) can be ordered separately.

NOTES

Rolling Pedestal can be rolled under a worksurface.

Yardage requirement for com or col is 0.75 yards based on a pattern of repeat of no more than 10cm horizontal or vertical. Larger repeats will require additional yardage.

PRODUCT OPTIONS

Drawer Configuration	Depth	Pull Style	Pull Finish	Case, Back & Front Finish	Key Style	Seat Cushion Included	Seat Cushion Finish (If applicable)
X Box/File	05 (48cm)	D District R Rectangular	Q Storm White P Espresso 7 Platinum C Latte V Very White	Source Laminate	K Keyed Alike R Keyed Randomly N No Lock	Y Yes N No	Grade 1 Fabric Grade 2 Fabric Fabric COM

SAMPLE ORDER CODE

SAMPLE ORDER CODE				Case	Back	Front			
MUPR X	05	D	7	X2	X2	X2	R	Y	X720

242

DIMENSIONS CM

PRICING

LATERAL FILE, 90CM H, BOX/FILE/FILE	
D	Case, Back & Front Finish, Source Laminate
048	768

IF SEAT CUSHION IS SPECIFIED PLEASE ADD THE FOLLOWING:

	COM/ Gr. 1	Gr. 2
	428	471

The Standard Lateral File provides high density filing storage in addition to a base to support most Stackers. It can also be used to support worksurfaces and panels.

WHAT'S INCLUDED

1 cabinet, drawers with pulls (as specified), lock and keys (if specified), counterweight (if specified).

NOTES

The 90cm high lateral file comes with a Box/File/File (W) drawer combination.

The 104cm high lateral file is available with File/File/File (R)

This product comes with extended levelers (MUNSXL) already installed.

MUFLS

Lateral File Standard

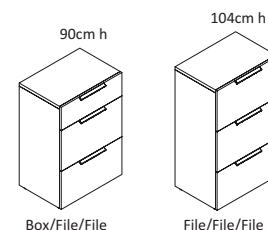

PRODUCT OPTIONS

Height	Drawer Configuration	Depth	Width	Pull Style	Pull Finish	Case, Back & Front Finish	Key Style	Counterweight
09 (90cm) 10 (104cm)	W Box/File/File R File/File/File	04 (41cm) 05 (48cm)	06,08,09	D District R Rectangular	Q Storm White P Espresso 7 Platinum C Latte V Very White	Source Laminate	K Keyed Alike R Keyed Randomly N No Lock	1 Yes 2 No

SAMPLE ORDER CODE

						Case	Back	Front		
MUFLS 09	W	05	08	D	7	X2	X2	X2	R	1

DIMENSIONS CM

PRICING

LATERAL FILE, 90CM H, BOX/FILE/FILE

Case, Back & Front Finish,
Source Laminate

D	W
041/41	06/60
041/41	08/80
041/41	09/90
048/48	06/60
048/48	08/80
048/48	09/90

1557
1608
1695
1634
1687
1779

LATERAL FILE, 104CM H, FILE/FILE/FILE

Case, Back & Front Finish,
Source Laminate

D	W
041/41	06/60
041/41	08/80
041/41	09/90
048/48	06/60
048/48	08/80
048/48	09/90

1639
1691
1783
1720
1776
1872

If Counterweight is specified, add 132

storage

MUBKS

Bookcase – Standard

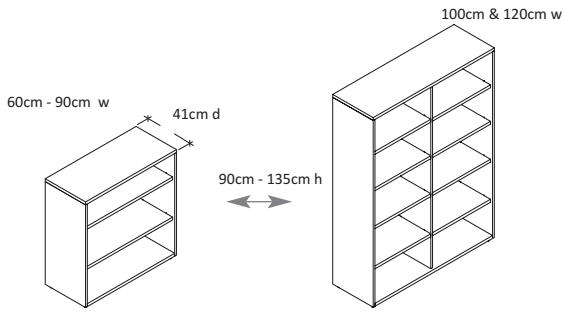

The Standard Bookcase provides height-adjustable shelves for binder storage in addition to a base to support most Stackers. It can also be used to support panels.

WHAT'S INCLUDED

1 cabinet;

Adjust. Shelves	60cm - 90cm w	100cm & 120cm w
90 cm h	2	4
104 cm h	2	4
135 cm h	3	6

NOTES

Bookcases cannot be stacked on top of other base units, must use Open Stackers.

PRODUCT OPTIONS

Height	Width	Case & Back Finish
09 (90cm) 10 (104cm) 14 (135cm)	06, 08, 09, 10, 12	Source Laminate

SAMPLE ORDER CODE

		Case	Back
MUBKS 09	06	X2	X2

244

DIMENSIONS CM

PRICING

BOOKCASE

D	W	Source Laminate
09/90	060/60	746
09/90	080/80	782
09/90	090/90	806
09/90	100/100	888
09/90	120/120	932
10/104	060/60	829
10/104	080/80	867
10/104	090/90	896
10/104	100/100	986
10/104	120/120	1037
14/135	060/60	867
14/135	080/80	900
14/135	090/90	936
14/135	100/100	1028
14/135	120/120	1078

MULHE

Low Open with Drawer Credenza – Elevated

The Elevated Low Open Drawer Credenza provides both file storage and open binder storage, the capability to support worksurfaces, stackers and panels and the ability to route and provide access to power and data.

WHAT'S INCLUDED

1 credenza, 2 District feet or 4 angled feet (as specified), 5cm high pencil drawer with removable organizing tray (if specified), lock and keys (if specified), counterweight (if specified), grommets (if specified), 120cm - 180cm widths include 1 file drawer and 1 pull; 200cm-220cm widths include 2 file drawers and 2 pulls.

WHAT'S EXCLUDED

A Seat Cushion (MUWLC) can be ordered separately. Can be found on page 296

NOTES

The 41cm deep credenza cannot be specified with a District Foot (D).

Electrical Cut Out options are not available when the District Foot (D) is specified. (N) must be selected.

When Base Back Electrical Cut Out (B) option is specified, the cut out will appear on the back and the base of the drawer unit. When there are two drawers (200cm - 220cm w) the cut out will appear on the outside drawer unit (not the center drawer). If Base & Top Grommet (T) is specified, grommet will appear in the cubby.

The 41cm deep credenza cannot be specified with Red Drawer Accessories.

If Red Drawer Accessories are selected on credenzas wider than 180cm (two drawers), the accessories will be located in the left drawer.

Grommets are finished in Platinum.

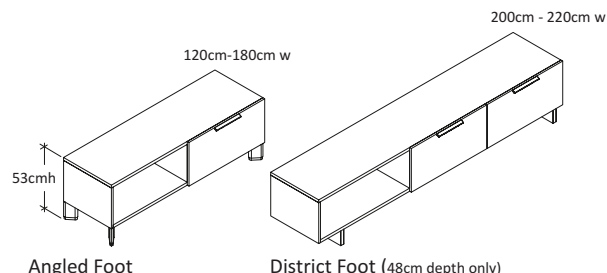

PRODUCT OPTIONS

Depth	Width	Open Compartment Location	Pull Style	Pull Finish	Case, Back & Front Finish	Foot Finish	Foot Style	Electrical Cut Out	Red Drawer Accessories	Key Style	Counterweight
04 (41cm) 05 (48cm)	12,14,15 16,18, 20,22	L Left (show) R Right	D District	Q Storm White	Source Laminate	Q Storm White	D District	B Base Back Cut Out	Y Yes	K Keyed Alike	1 Yes
			R Rectangular	P Espresso		P Espresso	A Angled Foot	N No	R Keyed Randomly	2 No	
				7 Platinum		7 Platinum		T Base & Top Grommet		N No Lock	
				C Latte		C Latte		N None			
				V Very White		V Very White					

SAMPLE ORDER CODE

Case Back Front

MULHE 05	12	L	D	7	X2	X2	X2	Q	A	B	Y	R	1
-------------	----	---	---	---	----	----	----	---	---	---	---	---	---

DIMENSIONS
CM

PRICING

LOW OPEN WITH DRAWER CREDENZA (ELEVATED) LEFT AND RIGHT

Case, Back & Front Finish, Source Laminate

D	W	Price
04/41	220/220	1343
04/41	140/140	1383
04/41	150/150	1421
04/41	160/160	1474
04/41	180/180	1526
04/41	200/200	1887
04/41	220/220	2093
05/48	220/220	1412
05/48	140/140	1452
05/48	150/150	1492
05/48	160/160	1548
05/48	180/180	1602
05/48	200/200	1984
05/48	220/220	2200

If Base Back Cut Out is specified, add 84

If Base & Top Grommet is specified, add 166

If Red Drawer Accessories are specified, add 166

If Counterweight is specified, add 132

storage

MUTW

Side Open Tower

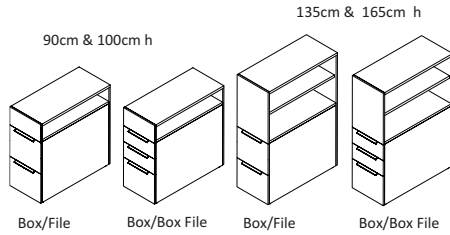

The Side Open Tower provides both file storage and open binder storage and the capability to support worksurfaces and panels.

WHAT'S INCLUDED

1 side open tower with drawers and pulls (as specified), 4 angled feet (if specified), height-adjustable shelves (depending on height and style selected), lock and keys (if specified).

NOTES

The Standard (S) tower is available with Box/Box/File (B) or File/File (F) drawer combinations.

Left/Right orientation is determined by the location of the open compartment.

Power and data access cannot be applied to the Side Open Tower.

The Standard(s) style comes with extended levelers (MUNSL) already installed.

PRODUCT OPTIONS

Style	Height	Depth	Width	Open Compartment Location	Drawer Configuration	Pull Style	Pull Finish	Case & Front Finish	Key Style
(S)Standard	09 (90cm) 10 (104cm) 14 (135cm) 16 (165cm)	05, 06, 07	104 (41cm)	L Left R Right (shown)	B Box/Box/File F File/File	D District R Rectangular	Q Storm White P Espresso 7 Platinum C Latte V Very White	Source Laminate	K Keyed Alike R Keyed Randomly N No Lock

SAMPLE ORDER CODE

								Case	Front		
MUTW S	14	05	104	L	B	D	7	X2	ZA	X2	R

DIMENSIONS CM

H	D	W
09/90	05/50	104/41
09/90	06/60	104/41
09/90	07/70	104/41
10/104	05/50	104/41
10/104	06/60	104/41
10/104	07/70	104/41
14/135	05/50	104/41
14/135	06/60	104/41
14/135	07/70	104/41
16/165	05/50	104/41
16/165	06/60	104/41
16/165	07/70	104/41

PRICING

SIDE OPEN TOWER, STANDARD, LEFT OR RIGHT

Case, Back & Front Finish, Source Laminate

Box/Box/File	File/File
984	942
1028	981
1094	1059
1095	1045
1142	1090
1215	1176
1282	1238
1379	1330
1519	1480
1557	1513
1682	1634
1866	1828

Linking Brackets connect storage units together.

WHAT'S INCLUDED

Linking brackets as per specified.

NOTES

When routing electrics beneath a storage spine, storage units must be linked together to ensure certification.

Finished in Platinum Grey.

MUNSLB Linking Bracket

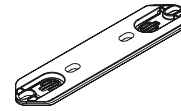

For Elevated Storage

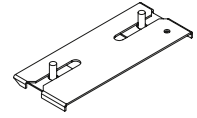

For Standard Storage

PRODUCT OPTIONS

Style	Quantity
E For Elevated Storage	04, 06, 12
S For Standard Storage	

SAMPLE ORDER CODE

MUNSLB S	12
----------	----

QUANTITY

PRICING

	PRICING	
	Elevated Storage	Standard Storage
4	56	56
6	84	84
12	160	166

M U N S X L

Storage Extended Leveling Kit

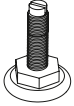

The Storage Extended Leveling Kit provides extended leveling height for District storage in standard configuration.

WHAT'S INCLUDED
Levelers as per specified.

NOTES

The following products come standard with extended levelers and there do not need to be purchased separately.

- Side Open Tower – Standard (MUTW)

This leveler allows the Standard Storage product to be levelled, 1.2cm down and 1.6cm up.

PRODUCT OPTIONS

Quantity

012, 024, 100

SAMPLE ORDER CODE

MUNSXL 012

248

QUANTITY

PRICING

12	71
24	132
100	388

supports

supports

PRODUCT MAP / TABLE OF CONTENTS	251
UNDERSTANDING DISTRICT SUPPORTS	256
WORKSURFACE SUPPORT BASICS – HORIZONTAL	257
WORKSURFACE SUPPORT BASICS – VERTICAL	258
WORKSURFACE SUPPORT, FREESTANDING BASICS	259
WORKSURFACE-TO-STORAGE SUPPORT BASICS	260
STORAGE-TO-PANEL SUPPORT BASICS	261
SELECTING THE CORRECT STORAGE-TO-PANEL BRACKET	262
PRODUCT LISTING	265

product map

MUNGEN End Gable

Page 265
Depth: 50cm - 80cm / Height: 74cm

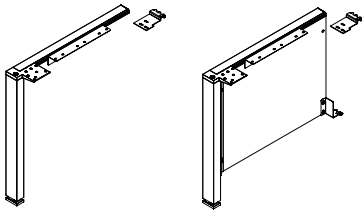

MUNGEAN End Gable – Height-Adjustable

Page 266
Depth: 50cm - 80cm / Adjustable Height: 66cm - 82cm

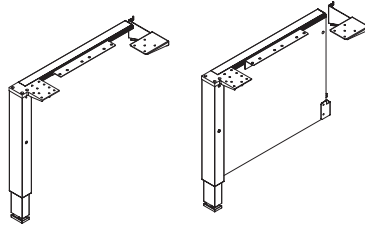

MUNGEF Flush End Gable

Page 267
Depth: 50cm - 80cm / Height: 74cm

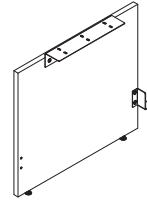

MUNGEFA Flush End Gable – Height-Adjustable

Page 268
Depth: 50cm - 80cm / Adjustable Height: 71cm - 79cm

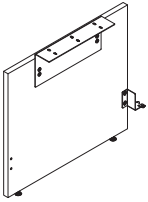

MUNGMF Mid Gable

Page 269
Depth: 30cm & 46cm / Height: 74cm

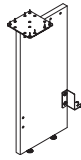

MUNGMFA Mid Gable – Height-Adjustable

Page 270
Depth: 30cm & 46cm / Adjustable Height: 71cm - 79cm

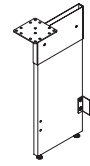

MUNLVR Cantilever

Page 271
Depth: 28cm & 36cm

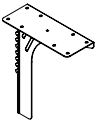

MUNLVFN Off-Module Cantilever

Page 272
Depth: 78cm & 36cm

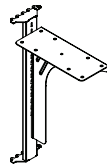

MUALVFN Cantilever for Panels with Accessory Beam

Page 273
Depth: 28cm & 36cm

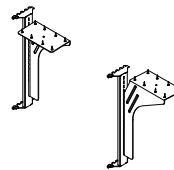

MUNGSN Semi-Suspended Gable

Page 274
Depth: 50cm, 60cm, 70cm & 80cm / Height: 74cm

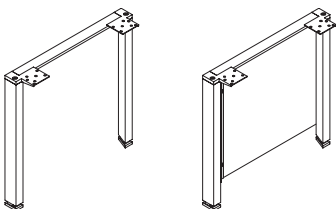

MUNGSAN Semi-Suspended Gable – Height-Adjustable

Page 275
Depth: 50cm, 60cm, 70cm, 80cm / Adjustable Height: 66cm - 82cm

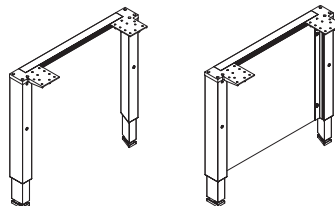

MUNLGN Leg – Single

Page 276
Height: 74cm

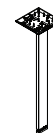

product map

MUNLGA Leg – Height-Adjustable
Single

Page 277
Adjustable Height: 66cm -82cm

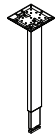

MUNLGPN Leg – Pair

Page 278
Height: 71cm

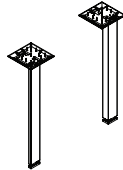

MUNLGPA Leg – Height-Adjustable
Pair

Page 278
Adjustable Height: 64cm

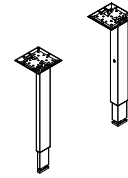

MUNBP Worksurface Panel Wall
Bracket – Pair

Page 279

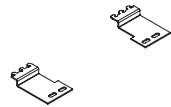

MUNBPA Worksurface Panel
Wall Bracket –
Height-Adjustable

Page 279

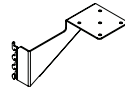

MUWSPB Storage-to-Panel Bracket

Page 280

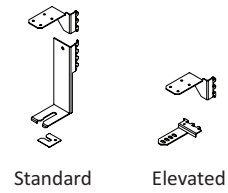

MUWBTH Height-Adjustable
Worksurface-to-Tower
Bracket Kit

Page 281

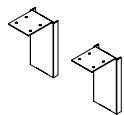

MUNCPWN Low Credenza-to-
Worksurface Support

Page 282

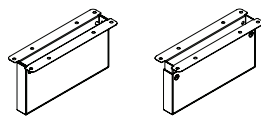

Fixed-Height Height-Adjustable

MUNRF Flush Plate

Page 283

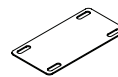

MUNRFS Structural Flush Plate

Page 283

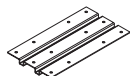

MUNRC Worksurface
Reinforcement Channel

Page 284
Width: 90cm- 240cm

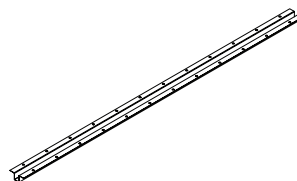

MYSLG hiSpace Single Leg

Page 285
Depth: 60cm, 70cm & 80cm / Height: 74cm



product map

MYSLGA hiSpaceAdjustable Single Leg

Page 286

Depth: 60cm, 70cm & 80cm / Height: 56cm-86cm

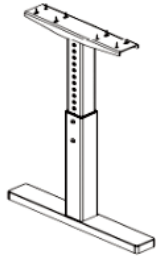

MUFFN Support Foot for Thin Panel District

Page 287



understanding district supports

The following outlines the guidelines for supporting panels and worksurfaces in panel-mounted applications.

- When planning with District panels, the end of run conditions must be supported at 15cm and 74cm high and at the front of a worksurface or storage. There are different ways of providing support, depending on whether storage or end gables are used
- When properly supported, the method of support forms a triangle

end of run with no storage

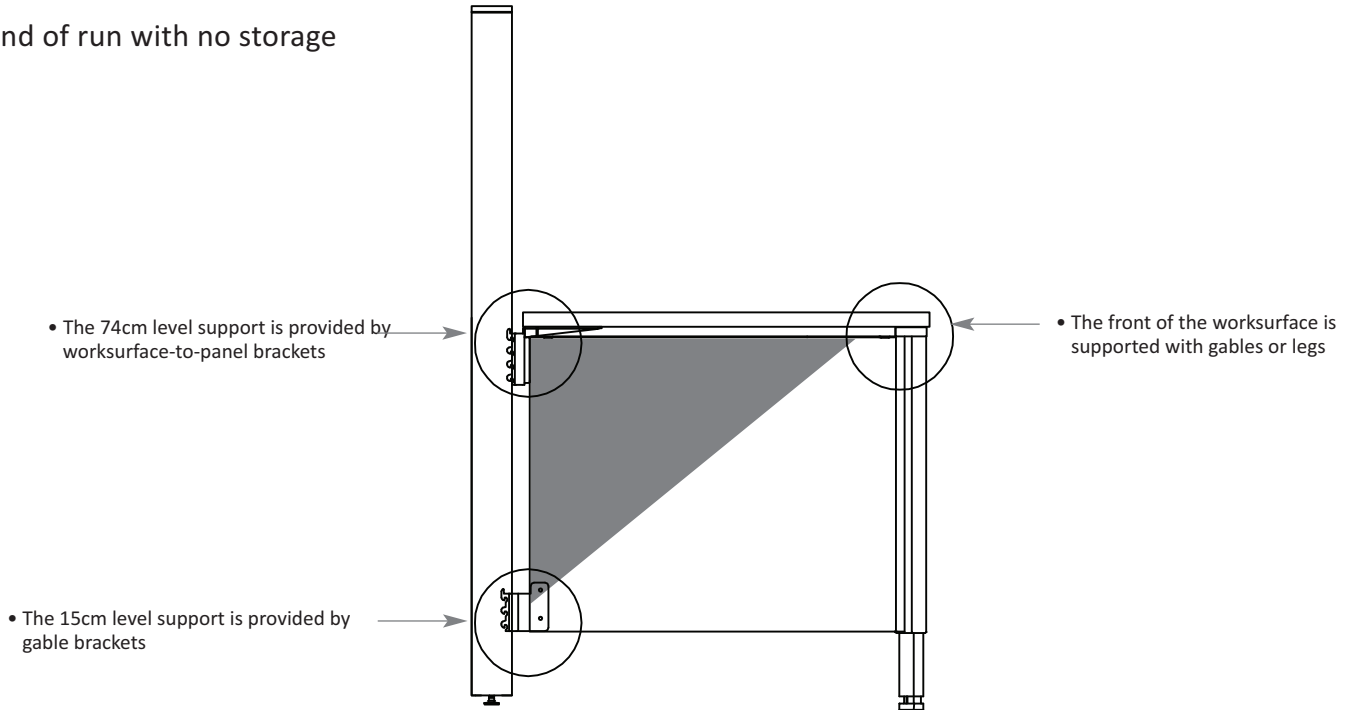

end of run with low storage

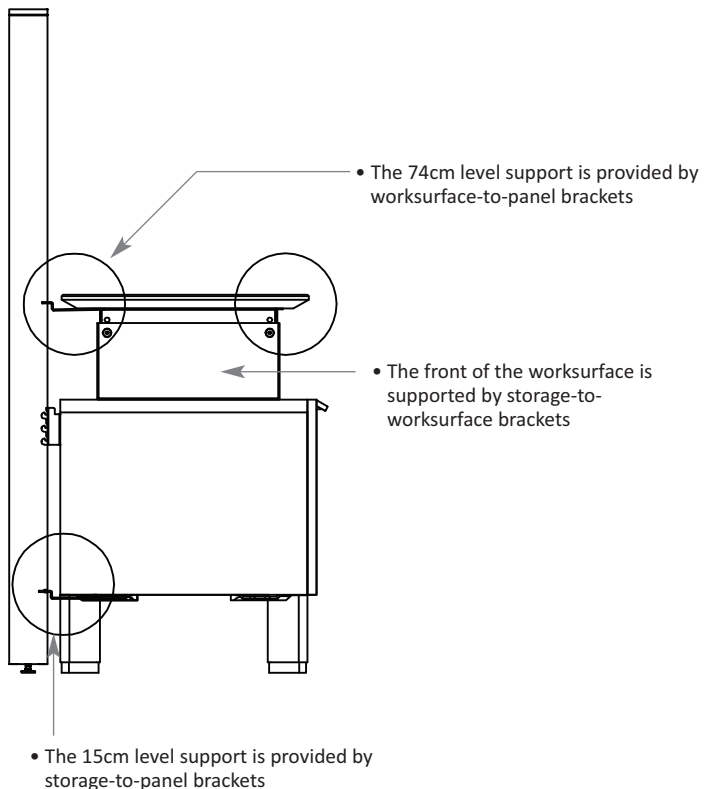

end of run with high storage

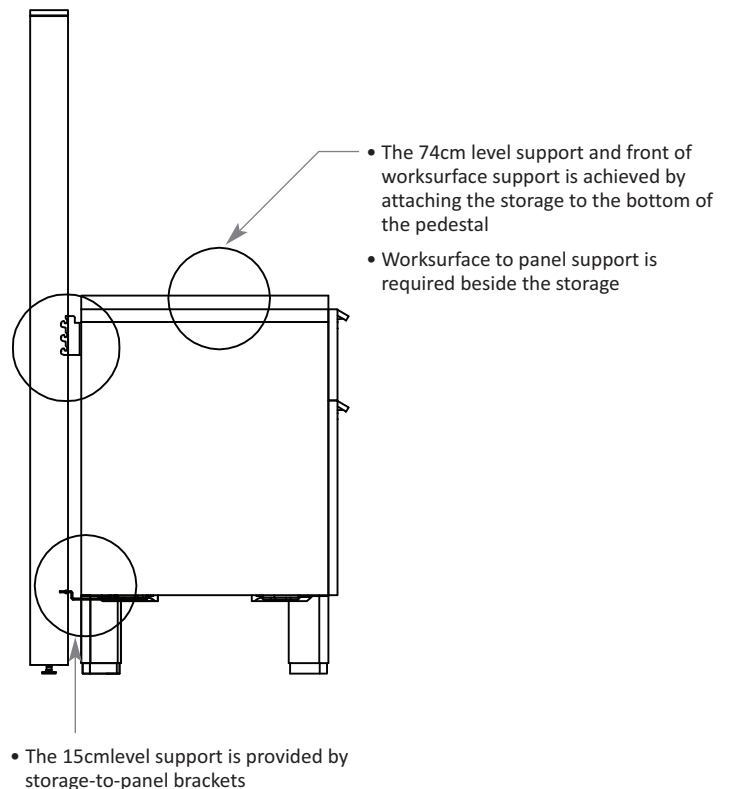

worksurface support basics – horizontal

The following outlines the features of supports that connect horizontally, either below worksurfaces, or for connecting worksurface to panel walls.

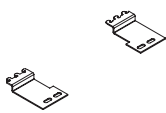
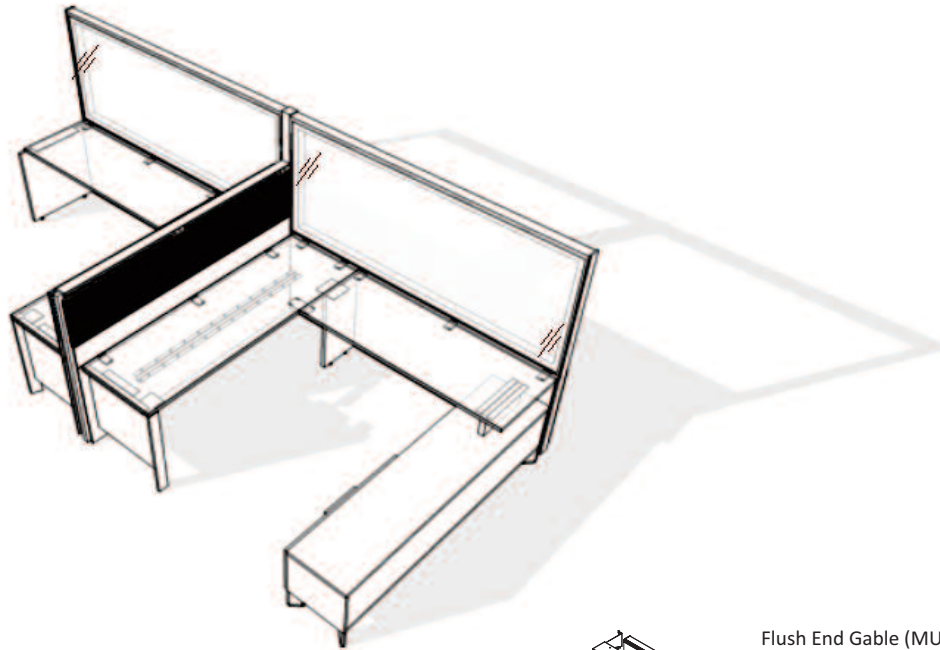

Worksurface Panel Wall Brackets (MUNBP)

- Off-module connectors that attach the worksurface to a Panel Wall
- Are mounted in the 74cm high horizontal rail and can be connected at any point along the width of the worksurface and Panel Wall but must be spaced minimally every 120cm
- Are not height-adjustable

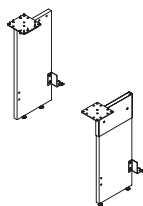

Mid Gable (MUNGMF) & Mid Gable – Height-Adjustable (MUNGMFA)

- Used on worksurface spans larger than 180cm to provide additional floor support or to join two worksurfaces, also includes a bracket at the 15cm high level to provide support to the panel wall if required
- (MUNGMFA) offers a height-adjustable leveling option with a range of 7.5cm (5cm above and 2.5cm below worksurface)

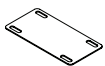

Flush Plate (MUNRF)

- Used in conjunction with other supports to maintain alignment of worksurfaces
- Cannot be used in freestanding applications, is used in panel wall application only
- Not required when cantilevers are used

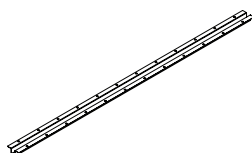

Worksurface Reinforcement Channel (MUNRC)

- Adds rigidity to worksurface to reduce deflection in the worksurface
- Required for all worksurfaces with an unsupported span over 120cm

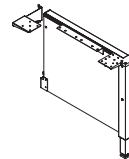

Flush End Gable (MUNGEF) & Flush End Gable – Height-Adjustable (MUNGEFA)

- Consists of a solid gable and a support to allow to be attached to the underside of a worksurface and to a panel available in depths to match 50cm, 60cm, 70cm, 80cm deep worksurfaces
- Available in depths to match 50cm, 60cm, 70cm & 80cm deep worksurfaces
- Available open or with an infill panel
- Cannot be used for supporting panels

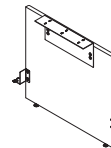

(MUNGEFA) offers a height-adjustable leveling option with a range of 7.5cm (5cm above and 2.5cm below worksurface)

- Provides floor support to a panel wall at the end of worksurface run and also has a bracket at the 15cm high level to provide panel support
- Cannot be used for supporting panels

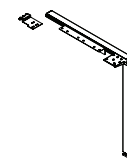

End Gable (MUNGEN) & End Gable – Height Adjustable (MUNGEAN)

- Consists of a single leg and a support to allow it to be attached to the underside of a worksurface and to the panel to provide floor support to a panel wall at the end of a worksurface run available in depths to match 50cm, 60cm, 70cm, 80cm, deep worksurfaces

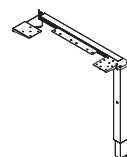

- Available in depths to match 50cm, 60cm, 70cm, 80cm deep worksurfaces

- Available open or with an infill panel
- (MUNGEAN) offers a height-adjustable leveling option with a range of 15cm (7.5cm) above and 7.5cm below worksurface)

- Cannot be used for supporting panels

worksurface support basics – vertical

The following outlines the features of vertical supports that allow for height adjustable worksurface mounting.

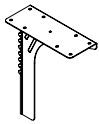
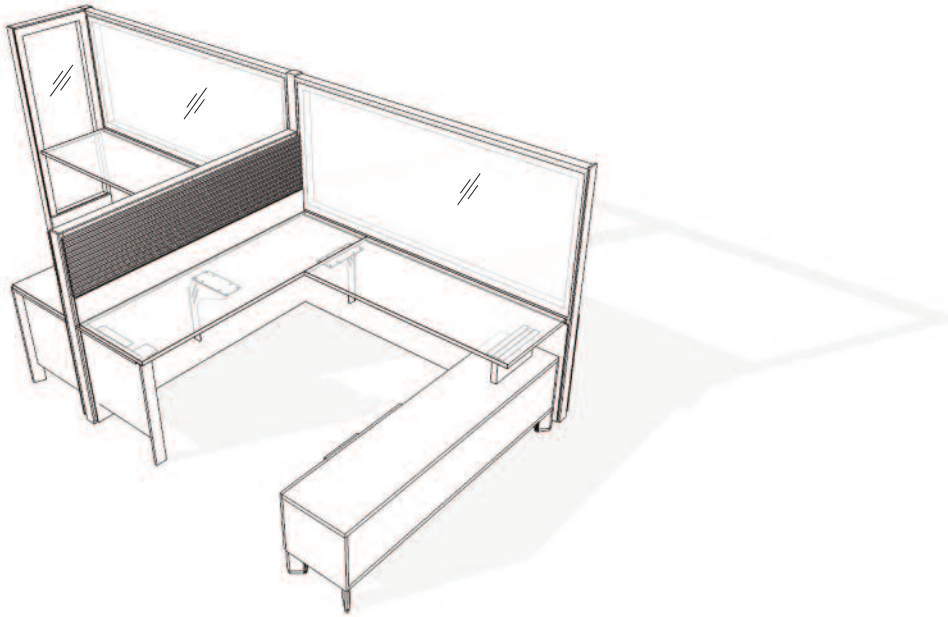

Cantilever (MUNLVR)

- Mounts into the center vertical channel of a panel wall over 150cm wide to provide on module height adjustable worksurface support at 2.5cm increments available in depths of 128cm & 36cm

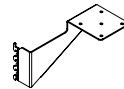

Worksurface Panel Wall Bracket – Height Adjustable (MUNBPA)

- Mounts into the vertical channel at the end of a Panel Wall to provide on-module height-adjustable support for worksurfaces
- Used with Flush Full-Height Windows – Single and Double Glazed (MUNPFWS, MUNPFWD) to support worksurfaces as no horizontal channel is available at 74cm high

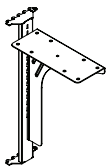

Off-Module Cantilever (MUNLVFN)

- Mounts in the 150cm and 74cm horizontal channels of the Panel Wall to allow for height-adjustable off-module applications
- Can be used in place of the Mid Gable (MUNGMF) and Height-Adjustable Mid Gable (MUNGMA), height-adjustable on an elevated panel as it does not extend below the 15cm horizontal rail available in depths of 28cm & 36cm

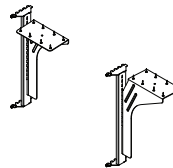

Cantilever for Panels with Accessory Beam (MUALVFN)

- Available in depths to match 28cm & 36cm
- Left or Right handed available
- Mounts into the center vertical channel of the panel to provide on-module height-adjustable worksurface support at 25cm increments
- Used only when using a panel frame with accessory rail in order to accommodate the gap from the beam

worksurface support, freestanding basics

The following outlines the features of supports that are typically used in freestanding or semi-supported environments.

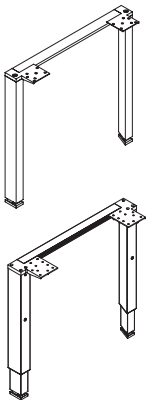
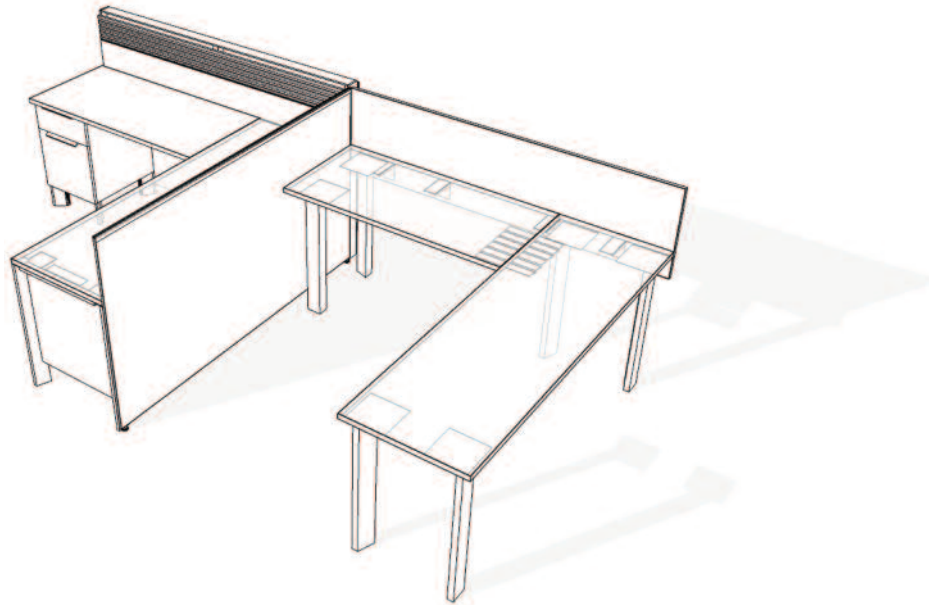

Semi-Suspended Gable (MUNGSN) & Semi-Suspended Gable – Height-Adjustable (MUNGSAN)

- Consists of two legs and a support, and is used at the open end of a panel wall mounted semi-suspended worksurface
- Available with or without an infill, standard or height adjustable
- Have a height-adjustable range of 15cm (7.5cm above and 75cm below)

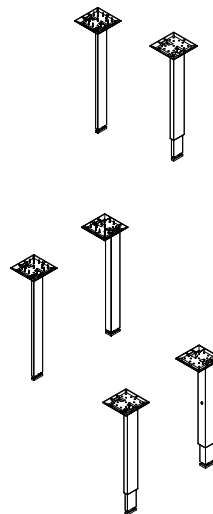

Leg – Single (MUNLGN), Leg – Height-Adjustable Single (MUNLGA), Leg – Pair (MUNLGN) and Leg – Height-Adjustable Pair (MUNLGPA)

- Used primarily in freestanding applications to provide worksurface support but can also be used for intermediate support in panel wall applications
- Available in single or pairs, standard or height-adjustable
- Have a height-adjustable range of 15cm (7.5cm above and 7.5cm below)

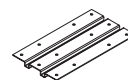

Structural Flush Plate (MUNRFS)

- Used to join two worksurfaces in freestanding application
- Two Structural Flush Plates used with a leg provides the required stability to create freestanding desks

worksurface-to-storage support basics

The following outlines the features of supports that connect storage to panel walls, worksurfaces and walls.

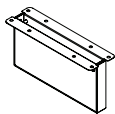
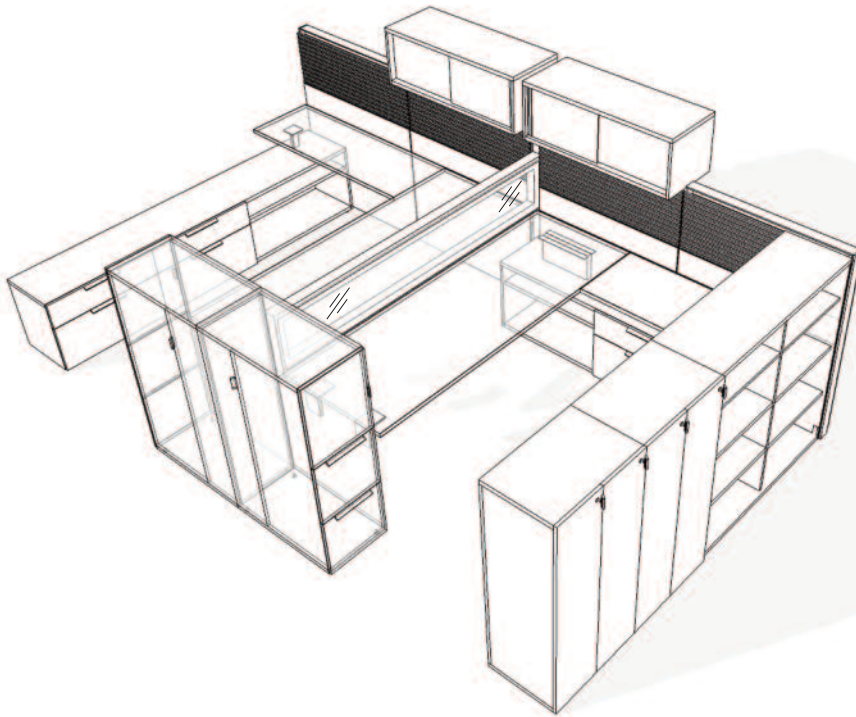

Fixed-Height

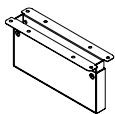

Height-Adjustable

Low Credenza-to-Worksurface Supports (MUNCPWN)

- Mount to the underside of a worksurface and to the top of a Low Credenza to provide support to the worksurface
- When used in combination with the Worksurface Panel Wall Bracket (MUNBP) and Storage-to-Panel Bracket (MUWSPB), support is provided for panels
- Offer a height-adjustable leveling option with a range of 10cm (75cm above the fixed height of 18cm or 2.5cm below the fixed height of 18cm)

storage-to-panel support basics

The following outlines the features the supports that connect storage-to-panels.

Storage-to-Panel Bracket (MUWSPB)

- Attaches to the back or side of a storage component and mounts into the vertical channel of a District panel, to provide support to a panel wall
- Options are available for parallel and perpendicular mounting at either the front or back of the cabinet
- Available with wire gap options
- Must be specified left or right handed, handedness being determined by the side of the panel to which storage is attached

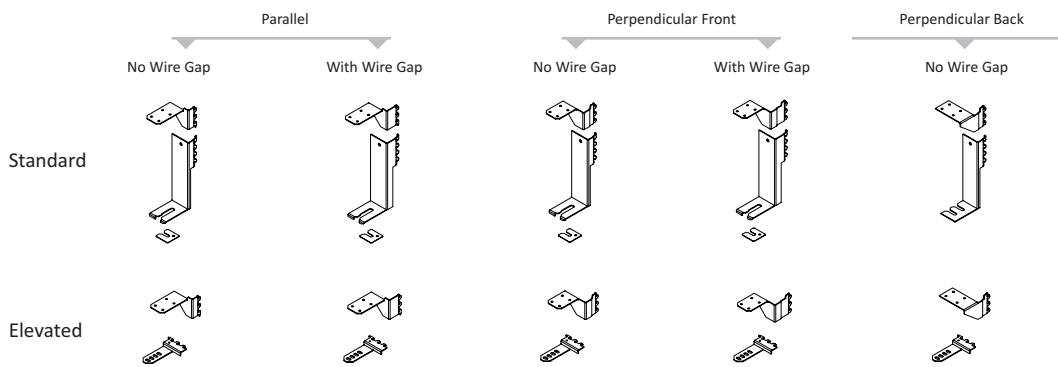

selecting the correct storage-to-panel bracket

All storage units attach to panels with either parallel, perpendicular front or perpendicular back brackets. The following outlines each option, and which cabinets use each individual option.

parallel mounting



		<ul style="list-style-type: none"> • 1cm offset (no gap) Elevated Storage 	<ul style="list-style-type: none"> • Used on storage with a closed back that fits flush or parallel to a panel wall • Bracket will attach to the storage unit through the slot located on the back of the unit • Available with 1cm offset when no gap is required between the storage and panel wall, and 2.5cm offset when a gap is required • Available for elevated and standard storage heights • Bracket fits into the vertical slots of the District panel wall • Handedness is determined by the side of the panel when facing it onto which the storage is mounted <p>Parallel mounting is used on the following storage units: MUBKS, MUFLS, all credenzas</p>
		<ul style="list-style-type: none"> • 2.5cm offset (with gap) Elevated Storage 	
		<ul style="list-style-type: none"> • 1cm offset (no gap) Standard Storage 	
		<ul style="list-style-type: none"> • 2.5cm offset (with gap) Standard Storage 	

perpendicular mounting, front

		<ul style="list-style-type: none"> • 1cm offset (no gap) Elevated Storage 	<ul style="list-style-type: none"> • Used when bracket is being attached to the inside of an open cubby space (not through a slot in the back). This mounting option is appropriate for units that have: <ul style="list-style-type: none"> - open section (open credenzas, bookcases, etc), - cubby back (single lockers, pedestals) and - door in the mounting location (dual lockers etc) • Available with 1cm offset when no gap is required between the storage and panel wall, and 2.5cm offset when a gap is required • Available for elevated and standard storage heights • Bracket fits into the vertical slots of the District panel wall • Handedness is determined by the side of the panel when facing it onto which the storage is mounted <p>Perpendicular mounting, front is used on the following storage units: MUBKS, MULHE</p>
		<ul style="list-style-type: none"> • 2.5cm offset (with gap) Elevated Storage 	
		<ul style="list-style-type: none"> • 1cm offset (no gap) Standard Storage 	
		<ul style="list-style-type: none"> • 2.5cm offset (with gap) Standard Storage 	

selecting the correct storage-to-panel bracket (continued)

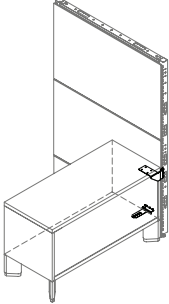
perpendicular mounting, back

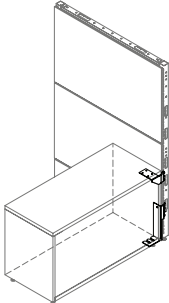
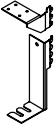
		<ul style="list-style-type: none"> • 10cm offset (no gap) Elevated Storage 	<ul style="list-style-type: none"> • Used on storage that sits perpendicular to the panel but attachment is through the back of the storage unit through the slots • Available with 10cm offset only (no gap) • Available for flush and elevated configurations • Bracket fits into the vertical slots of the Leverage panel
		<ul style="list-style-type: none"> • 14cm offset (no gap) Standard Storage 	<ul style="list-style-type: none"> • Handedness is determined by the side of the panel when facing it onto which the storage is mounted <p>Perpendicular mounting, back is used on the following storage units: MUBKS, MUFLS, all credenzas</p>

M U N G E N
End Gable

The End Gable provides end of run worksurface support. Available open or with infill options.

WHAT'S INCLUDED

1 leg and support 1 worksurface support bracket, leveler, attachment hardware.

NOTES

Handedness is determined by the user when seated at the adjoining worksurface (right handed shown).

Height dimension includes worksurface.

Not compatible with 72cm Fascia (see Supports section in Application Guide).

Brackets will be finished to match the frame finish. A Platinum paint is applied to brackets when an Anodized frame finish is specified.

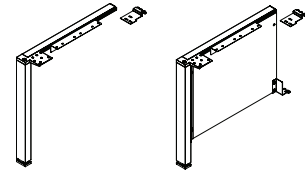

PRODUCT OPTIONS

Depth	Orientation	Infill	Frame Finish
05, 06, 07, 08	L Left R Right Handed (Shown)	0 No Infill 1 With Infill	Foundation Mica Clear Anodized

SAMPLE ORDER CODE

MUNGEN 06	L	0	R1
-----------	---	---	----

DIMENSIONS
CM

PRICING

END GABLE, LEFT OR RIGHT

D	NO INFILL (0)		WITH INFILL (1)	
	Source Laminate	Foundation Laminate	Source Laminate	Foundation Laminate
05 / 50	261	336	420	
06 / 60	265	353	441	
07 / 70	271	359	449	
08 / 80	276	372	465	

MUNGEAN

End Gable – Height-Adjustable

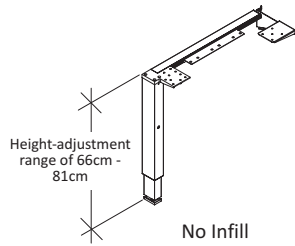

A End Gable – Height-Adjustable provides height-adjustable end of run worksurface support available open or with infill option.

WHAT'S INCLUDED

1 leg and support, leveler & attachment hardware, a Worksurface Panel Wall Bracket – Height-Adjustable (MUNBPA) with the same left/right orientation as specified on the End Gable.

NOTES

Handedness is determined by the user when seated at the adjoining worksurface (left handed shown).

Brackets will be finished to match the frame finish. A Platinum paint is applied to brackets when an Anodized frame finish is specified.

PRODUCT OPTIONS

Depth	Orientation	Infill	Infill Finish	Frame Finish
05, 06, 07, 08	L Left Handed	0 No Infill	Source Laminate	Foundation
	R Right Handed	1 With Infill	Foundation Laminate	Mica

SAMPLE ORDER CODE

MUNGEAN 06	L	0	R1	AC
------------	---	---	----	----

DIMENSIONS CM

PRICING

END GABLE HEIGHT ADJUSTABLE, LEFT OR RIGHT

D	NO INFILL (0)		WITH INFILL (1)	
			Source Laminate	Foundation Laminate
05 / 50	387		463	579
06 / 60	391		479	599
07 / 70	397		485	606
08 / 80	403		498	623

MUNGEF
Flush End

The Flush End Gable provides end of run worksurface support that is flush to the floor.

WHAT'S INCLUDED

Gable, levelers, brackets, attachment hardware.

WHAT'S EXCLUDED

Worksurface Panel Wall Bracket (MUNBP) must be specified separately. Can be found on page 279

NOTES

Height dimension includes thickness of worksurface.

Not compatible with 72cm Fascia (see Supports section in Application Guide).

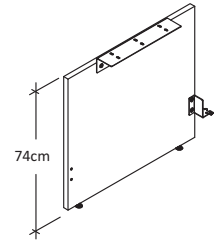

PRODUCT OPTIONS

Depth	Gable Finish	Bracket Finish
05, 06, 07, 08	Source Laminate Foundation Laminate	Foundation Mica

SAMPLE ORDER CODE

MUNGEF 06	R1	Q
-----------	----	---

DIMENSIONS
CM

PRICING

D	Gable Source Laminate	Gable Foundation Laminate
05 / 50	213	266
06 / 60	271	339
07 / 70	315	394
08 / 80	315	394

supports

MUNGEFA Flush End – Height-Adjustable

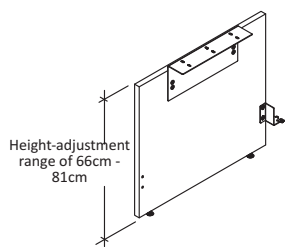

The Flush End Gable – Height-Adjustable provides height-adjustable end of run worksurface support that is flush to the floor.

WHAT'S INCLUDED

Gable, levelers, brackets, attachment hardware.

WHAT'S EXCLUDED

Worksurface Panel Wall Bracket – Height-Adjustable (MUNBPA) must be specified separately. Can be found on page 279

NOTES

Height dimension includes thickness of worksurface.

Not compatible with 72cm Fascia (see Supports section in Application Guide).

PRODUCT OPTIONS

Depth	Gable Finish	Bracket Finish
05, 06, 07, 08	Source Laminate Foundation Laminate	Foundation Mica

SAMPLE ORDER CODE

MUNGEFA 06	R1	Q
------------	----	---

DIMENSIONS CM

PRICING

D	Gable Source Laminate	Gable Foundation Laminate
05 / 50	268	335
06 / 60	326	408
07 / 70	371	464
08 / 80	384	480

M U N G M F
Mid Gable

The Mid Gable provides mid-span support to panel wall mounted worksurface.

WHAT'S INCLUDED

Mid gable, levelers, brackets, attachment hardware.

NOTES

Height dimension includes thickness of worksurface.

Cannot attach to flush panel with 71cm Fascia (see Supports section in Application Guide).

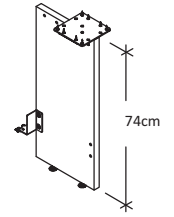

PRODUCT OPTIONS

Depth	Gable Finish	Bracket Finish
(30) 300mm	Source Laminate	Foundation
(46) 460mm	Foundation Laminate	Mica

SAMPLE ORDER CODE

MUNGMF 30	R1	Q
-----------	----	---

DIMENSIONS
CM

PRICING

D	Gable Source Laminate	Gable Foundation Laminate
30 / 30	183	229
46 / 46	266	333

supports

M U N G M F A

Mid Gable – Height-Adjustable

The Mid Gable – Height-Adjustable provides mid-span height-adjustable support to panel wall mounted to worksurface.

WHAT'S INCLUDED

Mid gable, levelers, brackets, attachment hardware.

NOTES

Height dimension includes thickness of worksurface.

Cannot attach to flush panel with 72cm Fascia (see Supports section in Application Guide).

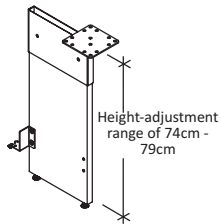

PRODUCT OPTIONS

Depth	Gable Finish	Bracket Finish
(30) 300mm	Source Laminate	Foundation
(46) 460mm	Foundation Laminate	Mica

SAMPLE ORDER CODE

MUNGMFA 30	R1	Q
------------	----	---

DIMENSIONS CM

PRICING

D	Gable Source Laminate	Gable Foundation Laminate
03 / 30	239	295
46 / 46	322	403

The Cantilever is applied on-module to a panel wall frame to support worksurfaces.

MUNLVR
Cantilever

WHAT'S INCLUDED

1 cantilever.

NOTES

Handedness is determined by the user when seated at the adjoining worksurface (right handed shown).

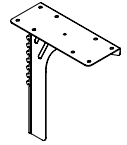

PRODUCT OPTIONS

Depth	Orientation	Finish
28, 36	L Left Handed R Right Handed (Shown)	Foundation Mica

SAMPLE ORDER CODE

MUNLVR 28	L	7
-----------	---	---

DIMENSIONS

CM

PRICING

D	CANTILEVER, LEFT OR RIGHT
28 / 28	75
36 / 36	75

supports

MUNLVFN Off-Module Cantilever

The Off-Module Cantilever is applied off-module to a panel wall frame to support worksurfaces.

WHAT'S INCLUDED
1 cantilever, 1 bracket.

NOTES
Not compatible with 72cm Fascia (see Supports section in Application Guide).
Handedness is determined by the user when seated at the adjoining worksurface.

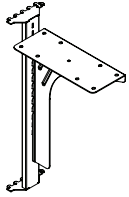

PRODUCT OPTIONS

Depth	Orientation	Finish
28, 36	L Left Handed (Shown) R Right Handed	Foundation Mica

SAMPLE ORDER CODE

MUNLVFN 28	R	Q
------------	---	---

DIMENSIONS CM

PRICING

D	OFF-MODULE CANTILEVER, LEFT OR RIGHT
28 / 28	127
36 / 36	127

The Off-Module Cantilever is applied off-module to a panel wall frame to support worksurfaces.

WHAT'S INCLUDED
1 cantilever, 1 bracket.

NOTES
Not compatible with all Fascia (see Supports section in Application Guide).
Handedness is determined by the user when seated at the adjoining worksurface.
Cantilever is to only be applied to District Panel that is supported by the Free standing Foot (MUAFFN).

M U A L V F N
Cantilever for Panels with
Accessory Beam

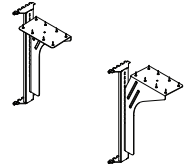

PRODUCT OPTIONS

Depth	Orientation	Finish
28, 36	L Left Handed R Right Handed	Foundation Mica

SAMPLE ORDER CODE

MUALVFN 14	L	7
------------	---	---

DIMENSIONS
CM

PRICING

D	CANTILEVER FOR PANELS WITH ACCESSORY BEAM, LEFT OR RIGHT
28 / 28	127
36 / 36	127

supports

MUNGSN

Semi-Suspended Gable

The Semi-Suspended Gable supports a worksurface semi-suspended from a panel wall.

WHAT'S INCLUDED

2 legs and support, levelers, attachment hardware.

NOTES

Height dimension includes thickness of worksurface.

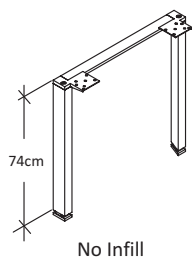

PRODUCT OPTIONS

Depth	Infill	Infill Finish	Frame Finish
05, 06, 07, 08	0 No Infill 1 With Infill	Source Laminate Foundation Laminate	AC Clear Anodized Foundation Mica

SAMPLE ORDER CODE

MUNGSN 06	0	R1	AC
-----------	---	----	----

DIMENSIONS CM

PRICING

SEMI SUSPENDED GABLE

D	WITH INFILL (1)	
	Source Laminate	Foundation Laminate
05/50	341	422
06/60	345	439
07/70	350	459
08 /80	357	471

If Mica is specified, add 32

*The above prices apply to panels finished in one fabric grade. If more than one fabric grade is specified on the screen, please refer to your specifying software for exact price

The Semi-Suspended Gable – Height-Adjustable provides height-adjustable support for worksurfaces semi-suspended from a panel wall.

WHAT'S INCLUDED

2 legs and support levelers, attachment hardware.

NOTES

Height dimension includes thickness of worksurface.

Bottom of infill option is 15cm above floor level at worksurface height.

MUNGSAN Semi-Suspended Gable – Height-Adjustable

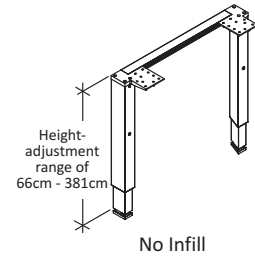

PRODUCT OPTIONS

Depth	Infill	Infill Finish	Frame Finish
05, 06, 07, 08	0 No Infill	Source Laminate	AC Clear Anodized
	1 With Infill	Foundation Laminate	Foundation Mica

SAMPLE ORDER CODE

MUNGSAN 06	0	R1	AC
------------	---	----	----

DIMENSIONS

CM

PRICING

SEMI SUSPENDED GABLE, HEIGHT ADJUSTABLE

D	NO INFILL (0)	WITH INFILL (1)	
		Source Laminate	Foundation Laminate
05 / 50	562	644	805
06 / 60	567	661	826
07 / 70	572	680	850
08 / 80	579	693	870

supports

MUNLGN Leg – Single

The Single Leg provides Intermediate worksurface support as an alternative to a mid gable or cantilever.

WHAT'S INCLUDED

1 leg, leveler, attachment hardware.

NOTES

Height dimension includes thickness of worksurface.

Handedness is determined by the user when seated at the adjoining worksurface.

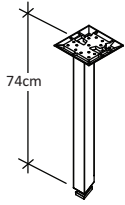

PRODUCT OPTIONS

Orientation	Finish
L Left Handed (Shown) R Right Handed	Foundation Mica AC Anodized

SAMPLE ORDER CODE

MUNLGN R	AC
----------	----

PRICING

LEG- SINGLE, LEFT OR RIGHT

155

The Height-Adjustable Single Leg provides intermediate height-adjustable worksurface support as an alternative to mid gable or cantilever.

WHAT'S INCLUDED

1 leg, leveler, attachment hardware.

NOTES

Height dimension includes thickness of worksurface.

Handedness is determined by the user when seated at the adjoining worksurface.

MUNLGA
Leg – Height-Adjustable Single

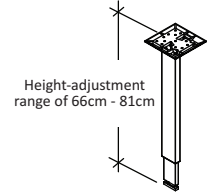

PRODUCT OPTIONS

Orientation	Finish
L Left Handed R Right Handed (Shown)	Foundation Mica AC Anodized

SAMPLE ORDER CODE

MUNLGA L	AC
----------	----

PRICING

LEG-HEIGHT ADJUSTABLE SINGLE, LEFT OR RIGHT

266

supports

MUNLGP N

Leg – Pair

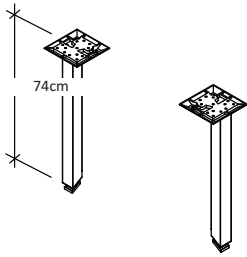

The Leg is used in combination with other storage based supports or legs to create freestanding desks or tables.

WHAT'S INCLUDED

2 legs, levelers, attachment hardware.

NOTES

Height dimension includes thickness of worksurface.

MUNLGPA

Height-Adjustable Leg – Pair

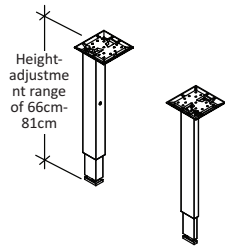

The Height-Adjustable – Leg is used in combination with other legs or storage based supports to create height-adjustable freestanding desks or tables.

WHAT'S INCLUDED

2 legs, levelers, attachment hardware.

NOTES

Height dimension includes thickness of worksurface.

PRODUCT OPTIONS

Finish

AC Clear Anodized

Foundation

Mica

SAMPLE ORDER CODE

UNLGPA AC

MUNLGP N
LEG – PAIR

304

MUNLGPA
HEIGHT-ADJUSTABLE LEG – PAIR

521

The Worksurface Panel Wall Bracket connects a worksurface to a panel wall providing support.

WHAT'S INCLUDED
2 brackets (one left oriented, one right oriented).

M U N B P
Worksurface Panel Wall Bracket –
Pair

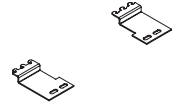

The Height-Adjustable Worksurface Panel Wall Bracket connects a worksurface vertically to a panel wall providing height-adjustable support.

WHAT'S INCLUDED
1 bracket

M U N B P A
Worksurface Panel Wall Bracket –
Height-Adjustable

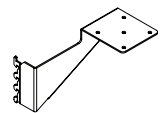

PRODUCT OPTIONS

Orientation (Applies to MUNBPA only)	Finish
L Left Handed (Shown) R Right Handed	Foundation Mica

SAMPLE ORDER CODE

MUNBPA R E

MUNBP
WORKSURFACE PANEL WALL BRACKET

50

MUNBPA
WORKSURFACE PANEL WALL BRACKET –
HEIGHT-ADJUSTABLE, LEFT OR RIGHT

39

M U W S P B

Storage-to-Panel Bracket

The Storage-to-Panel Bracket attaches to the back or side of a storage unit and mounts into the vertical channel of a District panel to provide support to the panel wall.

WHAT'S INCLUDED

1 top bracket, 1 bottom bracket, 1 plate (for some standard configurations) and attachment hardware.

NOTES

A Perpendicular Back (B) application is not available with a Wire Gap (W).

Handedness is determined by the side of the panel (when facing it) onto which the storage is mounted.

For details as to which application to choose, please see Planning Basics at the beginning of this section.

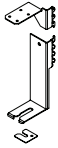

Standard



Elevated

PRODUCT OPTIONS

Storage Style	Application	Gapping	Orientation	Finish
E Elevated	P Parallel	W With Wire Gap	L Left	Foundation
S Standard	F Perpendicular Front B Perpendicular Back	N No Wire Gap	R Right	Mica

SAMPLE ORDER CODE

MUWSPB E	P	N	L	7
----------	---	---	---	---

PRICING

99

M U W B T H

Height-Adjustable
Worksurface-to-Tower Bracket Kit

The Height-Adjustable Worksurface-to-Tower Bracket is used to attach worksurfaces to storage.

WHAT'S INCLUDED
2 brackets and attachment hardware.

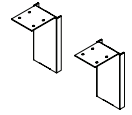

PRODUCT OPTIONS

Style	Finish
BB 2 Brackets	Foundation Mica

SAMPLE ORDER CODE

MUWBTH BB	7
-----------	---

STYLE

PRICING

BB	225
----	-----

supports

MUNCPWN

Low Credenza-to-Worksurface Support

The Low Credenza-to-Worksurface Support mounts to the underside of a worksurface and to the top of a low credenza to provide support for the worksurface.

WHAT'S INCLUDED

Brackets, as specified and attachment hardware.

NOTES

Adjustment range is +2.5cm/-2.5cm (71cm - 81cm worksurface height).

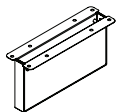

Fixed-Height

PRODUCT OPTIONS

Style	Finish
F Fixed-Height	Foundation
H Height-Adjustable	Mica

SAMPLE ORDER CODE

MUNCPWN F	7
-----------	---

STYLE

F
H

PRICING

LOW CREDENZA TO WORKSURFACE SUPPORT

145
166

The Flush Plate is used in conjunction with other supports to maintain alignment of worksurfaces.

WHAT'S INCLUDED
1 flush plate, attachment hardware.

NOTES
Finished in Ebony.

M U N R F
Flush Plate

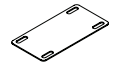

PRICING

FLUSH PLATE

33

The Structural Flush Plate is used in conjunction with other supports to maintain and provide structural support to freestanding worksurfaces.

WHAT'S INCLUDED
1 bracket.

NOTES
Finished in Ebony.

M U N R F S
Structural Flush Plate

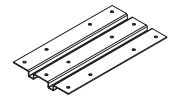

283

PRICING

STRUCTURAL FLUSH PLATE

43

MUNRC Worksurface Reinforcement Channel

The Worksurface Reinforcement Channel adds rigidity to worksurfaces.

WHAT'S INCLUDED
1 reinforced channel, attachment hardware

NOTES
Finished in Ebony

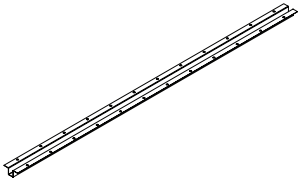

PRODUCT OPTIONS

Width

10, 12, 14, 15, 16, 18, 20, 22, 24

SAMPLE ORDER CODE

MUNRC 10

DIMENSIONS CM

PRICING

WORKSURFACE REINFORCEMENT CHANNEL

W	
10 / 100	21
12 / 120	23
14 / 140	24
15 / 150	27
16 / 160	29
18 / 180	31
20 / 200	33
22 / 220	35
24 / 240	42

hiSpace Single Leg provides intermediate worksurface support as an alternative to a Mid Gable or Cantilever

WHAT'S INCLUDED

1 Unit of hiSpace Single Leg

NOTES

This leg is not meant to be used for freestanding application

M Y S L G
hiSpace Single Leg



PRODUCT OPTIONS

Depth	Finish
060, 070, 080	(V) Very White (7) Platinum

SAMPLE ORDER CODE

MYSLG 06	V
----------	---

DIMENSIONS
CM

PRICING

HISPACE SINGLE LEG

D	
060/60	206
070/70	220
080/80	234

M Y S L G A

hiSpace Adjustable Single Leg

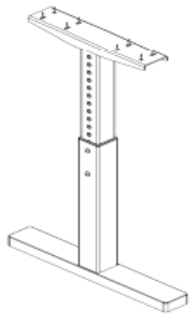

hiSpace Adjustable Leg provides intermediate height adjustable worksurface support as an alternative to meet gable or cantilever

WHAT'S INCLUDED

1 Unit of hiSpace Adjustable Single Leg

NOTES

This leg is not meant to be used for freestanding application

PRODUCT OPTIONS

Depth	Finish
060, 070, 080	(V) Very White (7) Platinum

SAMPLE ORDER CODE

MYSLGA 06	V
-----------	---

DIMENSIONS CM

PRICING

HISPACE ADJUSTABLE SINGLE LEG

D	
060/60	284
070/70	298
080/80	312

The Support Foot is added to flush thin panels to allow them to become freestanding.

WHAT'S INCLUDED

1 double-sided metal freestanding foot and panel attachment brackets.

NOTES

Freestanding Foot can be applied to the Flush Thin Panel

M U F F N
Support Foot for Thin Panel District



PRODUCT OPTIONS

Orientation	Finish
(D) Double	Foundation Mica

SAMPLE ORDER CODE

MUFFN D	Q
---------	---

PRICING

225

accessories

accessories

PRODUCT MAP / TABLE OF CONTENTS	289
ACCESSORY OVERVIEW	292
SEAT CUSHION BASICS	293
COMPLEMENTS ACCESSORY BASICS	294
PRODUCT LISTING	296

MUWLC Seat Cushion

Page 296

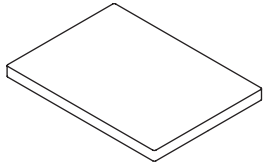

MUTPS Signage

Page 297

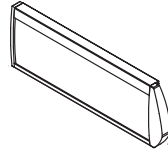

accessory overview

A variety of accessories are available to enhance the functionality to District workstations.

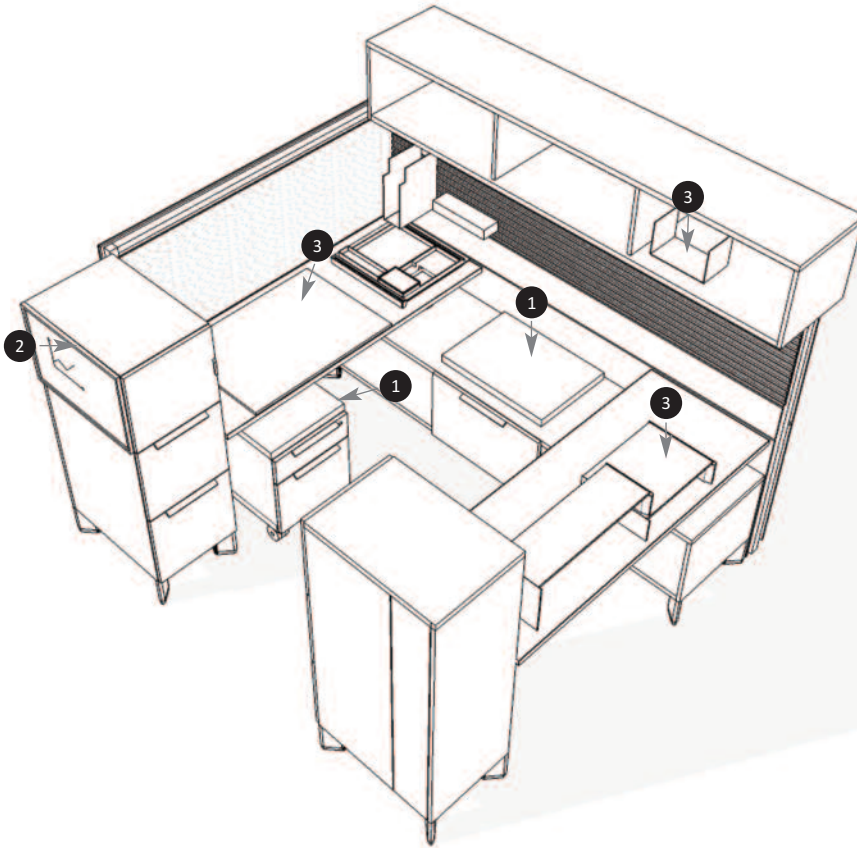

- 1 Seat cushions provide additional guest seating in a workstation and are available for low credenzas or rolling pedestals.
- 2 Side Tower provide the ability to enclose and add functionality to open cubbies with options for solid whiteboard and tackboard depending on format.
- 3 The Teknion Complements program offers additional accessories such as desk pads, binder dividers organizing trays for storing smaller items, and Podium.

seat cushion basics

The following options are available for District seat cushions.

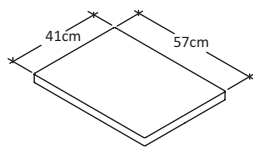
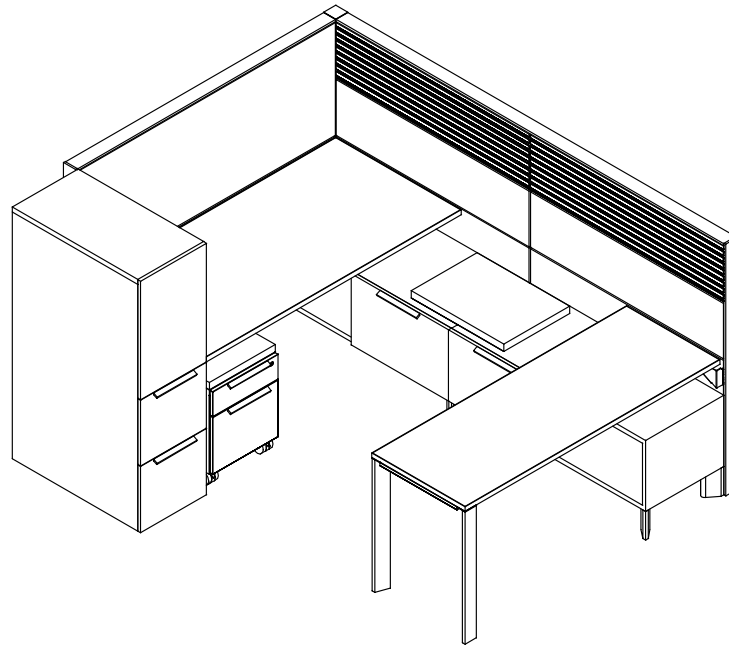

Credenza

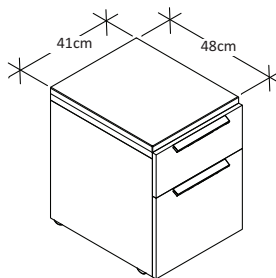

Pedestal

Seat Cushion (MUWLC)

- Provides space saving casual guest seating in a workstation
- Available in two options:
 - C - used on low credenzas (placed upon but not affixed)
 - R - mounted onto rolling pedestals only
- Can be specified on the Rolling Pedestal (MUPR) at the time of order, or can be ordered separately and retrofitted onto an existing Rolling Pedestal
- The credenza option is sized to be used on 41cm and 48cm deep credenzas
- Available in all of Teknion's standard Seating fabrics

complements accessory basics

Teknion's Ergonomics & Accessories program, Complements, offers a number of accessories that are designed for use with District.

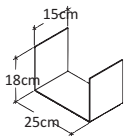
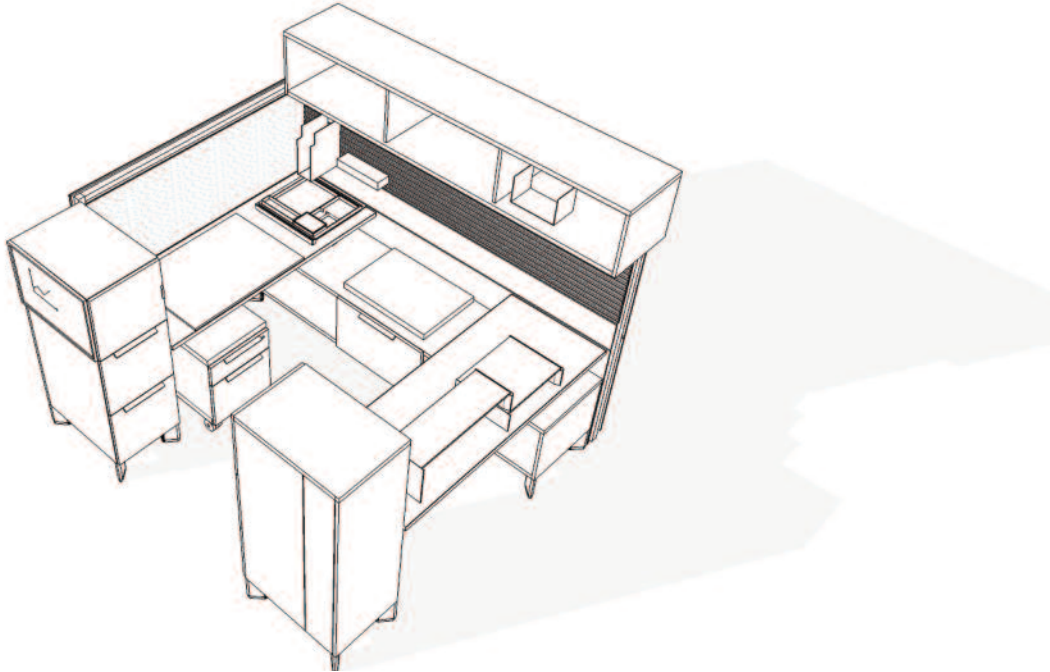

Binder Divider (MUNAD)

- Supports binders for all shelf applications
- Finished in anodized aluminum
- Includes anti-slip undersurface

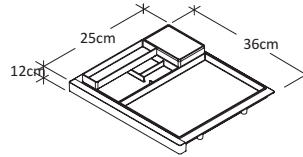

Organizing Trays (MYWOT1)

- A collection of accessories to store small personal items
- Trays are modular and stackable, and are transferable to other storage media including, overhead cabinets, towers, shelves, credenza's and worksurfaces

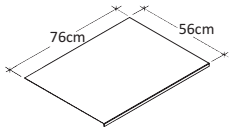

Desk Pad (MYPDP)

- Lays onto any thickness of worksurface with a flat or knife edge style without tools
- Can span the corner between two worksurfaces to create a conventional angled computer corner
- Includes an integral cable management retainer for easy laptop plug in

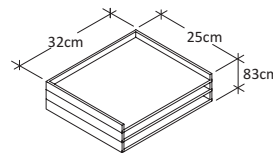

Paper Stacking Trays (MYWOT2)

- Include a set of three letter/A4 size trays
- Can be stacked in-line or offset

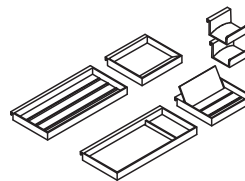

fx Personal Organizers

- A collection of accessories that mount to the accessory rail or used freestanding on the desk to organize paper and accessories off the desk surface

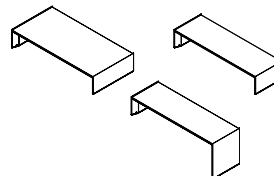
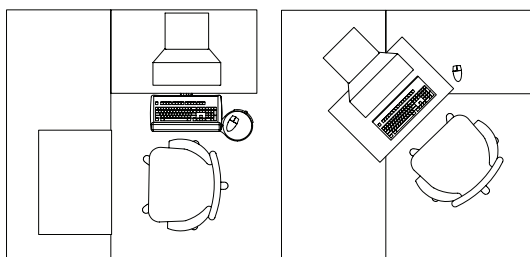

Podium

- A collection of shelves & accessories to organize laptops, flat screen monitors, and multiple hand-held electronic peripherals

- The desk pad is typically used on the primary worksurface, however it can also span across the corner of two worksurfaces to create a conventional angled computer corner – the steel inner construction provides the stability required to support a keyboard tray – cannot be used if the two surfaces are at different heights

M U W L C Seat Cushion

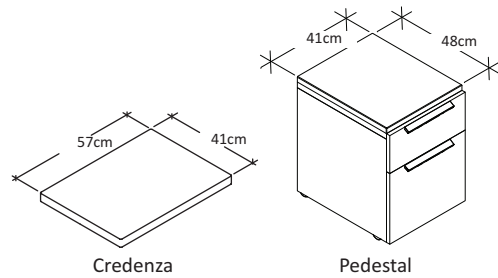

The Seat Cushion is removable and is intended to provide casual guest seating when applied to a low credenza top or rolling pedestal.

WHAT'S INCLUDED

1 seat cushion.

NOTES

Yardage requirement for com or col is 0.75 yards based on a pattern of repeat of no more than 10cm horizontal or vertical. Larger repeats will require additional yardage.

PRODUCT OPTIONS

Style	Upholstery Finish
R Rolling Pedestal C Credenza	Grade 1 Grade 2 Fabric COM

SAMPLE ORDER CODE

MUWLC R	X720
---------	------

PRICING

	FABRIC	
	Gr.1	Gr.2/COM
Seat Cushion, Credenza	317	360
Seat Cushion, Rolling Pedestal	317	360

Signage is to provide identification on workstations

WHAT'S INCLUDED

1 Signage

NOTES

Can be mounted to the panel via the horizontal rail or the Accessory Elements and rails.

Can be linked together to provide individual identification in clustered workstations or grouped areas.

Name tags can be easily created and maintained using standard word processing programs.

MUTPS Signage

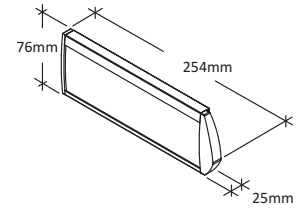

PRODUCT OPTIONS

Finishes

Foundation

Mica

SAMPLE ORDER CODE

MUTPS7

PRICING

58

electrics

electrics

PRODUCT MAP / TABLE OF CONTENTS299

ELECTRICS & COMMUNICATIONS OVERVIEW302

POWER ENTRY BASICS –
PANEL-MOUNTED WORKSTATIONS303

PRODUCT LISTING304

MUNQEP Power Pole

Page 304
Length:120cm-240cm

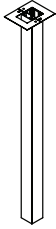

MUBT Cable Tray

Page 305
Length:100cm-180cm

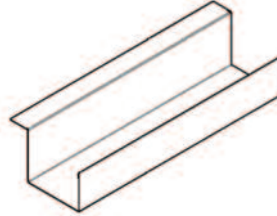

electrics & communications overview

District offers a non-directional wiring system that allows for maximum flexibility and simple reconfiguration.

- ⚠ • Power must be turned off during all installations and reconfigurations

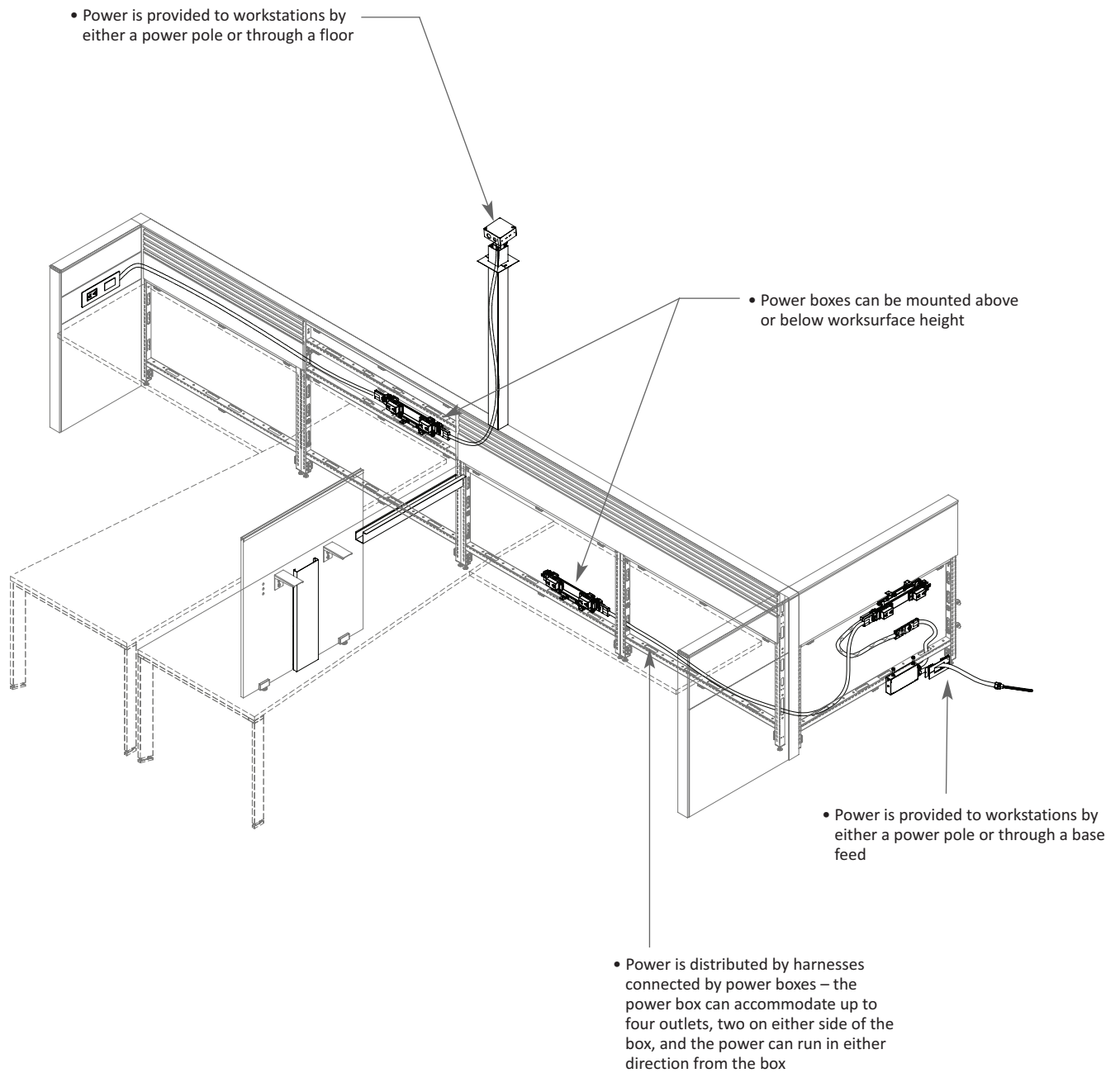

power entry basics – panel-mounted workstations

Power and communications cables enter a workstation either through a base feed or a ceiling feed. The options are detailed below. The following outlines the features of the electrical and communication components available for use in District panel environments.

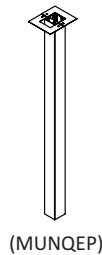
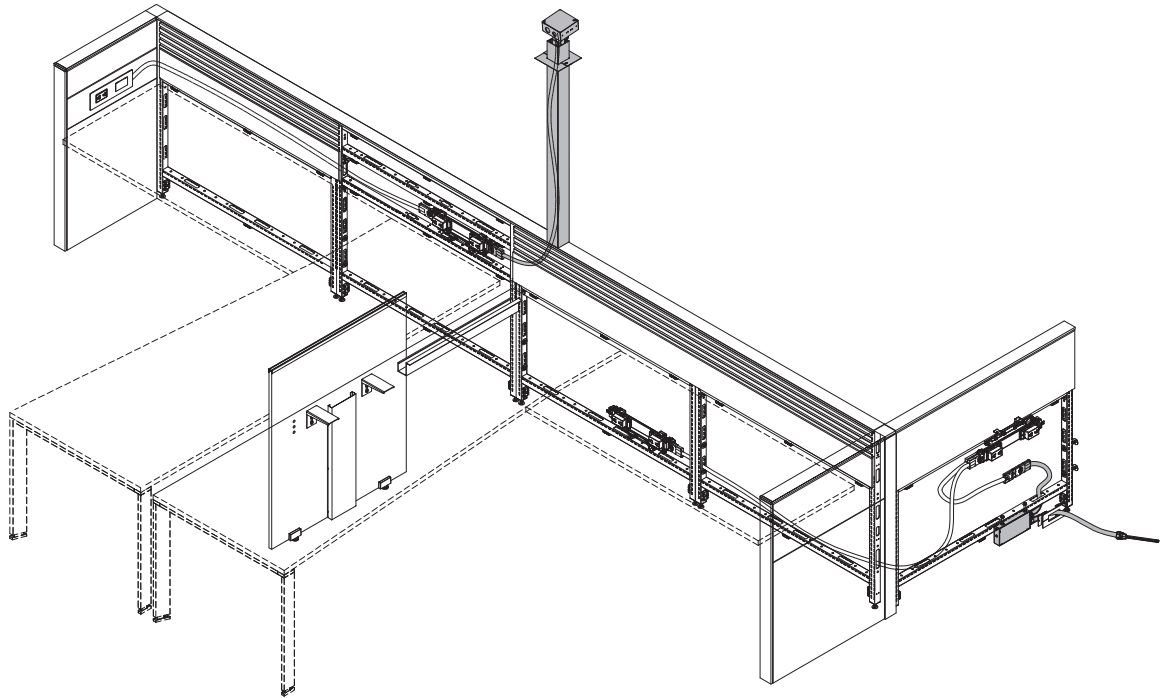

Power Pole (MUNQEP)

- Used to house the ceiling feed and includes a pole divider for separating the ceiling power feed from the communications and data cables
- Available in 120cm, 180cm and 240cm heights for up to 305cm ceilings
- Available in options for corner mounting and off-module mounting

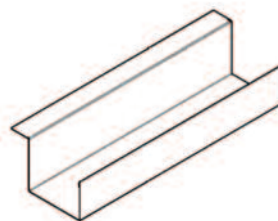

Cable Tray(MUBT)

- Used to house the access cables and wires
- Available in length of 100cm to 180cm
- To be mounted underside of the workspace

MUNQEP Power Pole

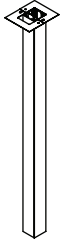

The Power Pole houses the ceiling feed and includes a pole divider for separating the ceiling feed from communications and data cables.

WHAT'S INCLUDED

Power pole, power pole cover, mounting bracket, attachment hardware, ceiling trim plate.

NOTES

Used for corner or off-module locations.

PRODUCT OPTIONS

Length	Finish	Mounting Application
12, 18, 24	AC Clear Anodized Foundation Mica	1 Corner 2 Off-Module

SAMPLE ORDER CODE

MUNQEP 18	AC	1
-----------	----	---

DIMENSIONS CM

PRICING

L	
12 / 120	240
18 / 180	313
24 / 240	375

Cable tray channels cable under worksurfaces

WHAT'S INCLUDED

Cable Tray Hardware

NOTES

Attaches to worksurfaces

M U B T
Cable Tray for District
Thin Panel

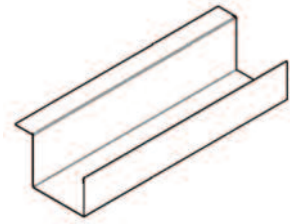

PRODUCT OPTIONS

Length	Finish
10, 12, 14, 15, 16, 18	Foundation Mica

SAMPLE ORDER CODE

MUBT 16	7
---------	---

DIMENSIONS
CM

PRICING

W	Foundation Colour	Mica Colour
10 / 100	70	72
12 / 120	78	80
14 / 140	93	96
15 / 150	97	100
16 / 160	101	104
18 / 180	111	114

teknion

www.teknion.com

TEKNION ASIA HQ:
Lot 761 Jalan Haji Sirat
Off Jalan Meru,
42100 Klang, Selangor
Malaysia
Tel 603-3342-4345

IN CANADA:
1150 Flint Road
Toronto, Ontario
M3J 2J5 Canada
Tel 866.teknion
866.835.6466

IN THE USA:
350 Fellowship Road
Mt Laurel, New Jersey
08054 USA
Tel 877.teknion
877.835.6466

OTHER OFFICES LOCATED IN:
Europe, South and Central America
Middle East, Asia and Russia
For regional contact information
go to www.teknion.com

MY IO
©Teknion 2016

®, ™ trade marks of Teknion
Corporation and/or its subsidiaries or
licensed to it. Patents may be pending.

Some products may not be available in
all markets. Contact your local
Teknion Representative for availability.